



BAHCO

Catalogue
2024



Catalogue 2024

Catalogue

Contents	2-9
Alphanumerical index	665-745
Warranty	751

12 BANDSAWS & POWER SAWS

21-36 FILES



37-60 WRENCHES



61-102 SOCKETS & RATCHETS



103-122 TORQUE TOOLS



123-186 POWER TOOL ACCESSORIES



BAHCO

187-220 SCREWDRIVERS



221-230 L-KEYS



231-264 PLIERS



265-272 PIPE WRENCHES & TUBING TOOLS



273-288 AIR TOOLS



289-294 CORDLESS POWER TOOLS



295-356 AUTOMOTIVE TOOLS



357-358 LIGHTING EQUIPMENT



359-362 INSPECTION TOOLS



363-372 EXTRACTORS & PULLERS



373-470 TOOL STORAGE & TOOLKITS



471-490 TOOLS @ HEIGHT



491-504 INSULATED TOOLS



505-524 NON SPARKING TOOLS



525-530 STAINLESS STEEL TOOLS



531-536 TWEEZERS & ELECTRONICS SPECIALTY TOOLS



537-546 MEASURING & LAYOUT



547-554 WALL TOOLS



555-558 HAND HACKSAWS



559-568 HANDSAWS



569-574 WOOD CHISELS



575-586 SCISSORS & KNIVES



587-590 CLAMPS & VICES



591-598 HAMMERS



599-602 TREE FELLING & FORESTRY TOOLS



603-610 COLD CHISELS & PUNCHES



611-614 PRY BARS



615-618 PLANTING & CULTIVATING TOOLS



619-638 PRUNING TOOLS



639-642 AIR TOOLS OUTDOOR



643-666 LINDSTRÖM



Contents

Bandsaws & Power Saws	11-20	Screwdrivers	187-220
METAL CUTTING BI-METAL BANDSAWS	12	ERGO™ SCREWDRIVERS WITH RIGGED RUBBER GRIP & COLOUR ID	188
METAL CUTTING TRI-METAL BANDSAWS	15	ERGO™ SCREWDRIVERS WITH IMPACT GRIP	198
METAL CUTTING CARBIDE BANDSAWS	15	BAHCOFIT SCREWDRIVERS WITH GROOVED RUBBER GRIP	200
WOOD CUTTING BANDSAW	17	SCREWDRIVERS WITH RUBBERED GRIP	208
INSULATION CUTTING BANDSAWS	17	SCREWDRIVERS WITH RATCHETING GRIP	211
HSS CIRCULAR SAWBLADES	17	SCREWDRIVERS WITH PRECISION GRIP	212
POWER HACKSAW BLADES	18	SCREWDRIVERS WITH T-HANDLE GRIP	215
BANDSAW ACCESSORIES	20	SCREWDRIVERS WITH 1/4" BIT HOLDERS	216
		SCREWDRIVERS WITH WOODEN OR PLASTIC GRIP	217
Files	21-36	ELECTRICAL TESTERS	219
ENGINEERING FILES	22	ACCESSORIES	219
SHARPENING FILES	26		
RASPS	30	L-Keys	221-230
MILLED TOOTH FILES	31	HEXAGONAL TIPPED	222
NEEDLE FILES	31	TORX® TIPPED	226
DIAMOND FILES	34	DOUBLE OFFSET	229
ACCESSORIES	35	MULTITOOLS	229
Wrenches	37-60	Pliers	231-264
ADJUSTABLE WRENCHES	38	CUTTING PLIERS	232
COMBINATION WRENCHES	40	COMBINATION PLIERS	239
RATCHETING WRENCHES	45	GRIPPING PLIERS	241
OPEN END WRENCHES	48	WATERPUMP PLIERS	247
RING END WRENCHES	52	CIRCLIP PLIERS	249
FLARE NUT WRENCHES	54	WIRE STRIPPERS & DISMANTLING TOOLS	251
SLOGGING WRENCHES	55	CRIMPING PLIERS	254
SOCKET WRENCHES	56	PLIERS SETS	257
MULTIFITTING KEYS	59	LOCKING PLIERS	259
HOOK WRENCHES	60	RIVETING TOOLS	263
		SPECIAL PLIERS	264
Sockets & Ratchets	61-102	Pipe Wrenches & Tubing Tools	265-272
SOCKET SETS	62	PIPE WRENCHES	266
1/4"	78	TUBE CUTTING TOOLS	268
3/8"	85	BENDING & FORMING TOOLS	270
1/2"	91	DEBURRING TOOLS	271
3/4"	98		
1"	101		
EMPTY SOCKET SET CASES	102		
SCAFFOLDING WRENCHES	102		
Torque Tools	103-122	Air Tools	273-288
DIGITAL TORQUE WRENCHES	104	IMPACT WRENCHES	274
MECHANICAL TORQUE WRENCHES	106	RATCHETS	277
TORQUE SCREWDRIVERS	111	GRINDERS, SANDERS & POLISHERS	277
MULTIPLIERS	113	DRILLS & SCREWDRIVERS	282
TORQUE TESTERS	114	CUTTING TOOLS	283
TORQUE ANGLE ADAPTORS	115	HAMMERS, RIVETERS & MARKERS	284
INSERT TOOLS	115	PAINT GUNS	285
EMPTY SET CASES FOR TORQUE TOOLS	121	BLOWING & CLEANING TOOLS	286
		AIR TOOLS ACCESSORIES & EQUIPMENT	286
Power Tool Accessories	123-186	Cordless Power Tools	289-294
HOLESAWS	124	IMPACT WRENCHES	290
SABRE SAWBLADES	134	RATCHETS	290
JIGSAW BLADES	138	DRILLS & SCREWDRIVERS	291
MULTI TOOL ACCESSORIES	139	GRINDERS, SANDERS & POLISHERS	292
CIRCULAR SAW BLADES	141	CUTTING TOOLS	292
ABRASIVE CUTTING DISCS	142	GREASERS	293
BANDSAW BLADES	143	BATTERIES & CHARGERS	293
CARBIDE ROTARY BURRS	144		
DRILL BITS	148		
SCREWDRIVER BITS	156		
IMPACT TOOLS	172		



Automotive Tools	295-356
ENGINE TOOLS	296
EXHAUST TOOLS	318
OIL SERVICE TOOLS & EQUIPMENT	319
BRAKE SYSTEM TOOLS & EQUIPMENT	324
TRANSMISSION & WHEEL TOOLS	328
SUSPENSION TOOLS & EQUIPMENT	336
BATTERY MANAGEMENT & ELECTRICAL TOOLS	337
PRESSES & ACCESSORIES	341
GENERAL AUTOMOTIVE TOOLS AND EQUIPMENT	342
BODY SHOP TOOLS	344
LIFTING EQUIPMENT	349

Lighting Equipment	357-358
HAND LIGHTS	358
HEAD LIGHTS	358
CABLE REELS	358

Inspection Tools	359-362
ENDOSCOPES	360
STETHOSCOPES	360
MIRRORS	360
MAGNIFIERS	361

Extractors & Pullers	363-372
MECHANICAL	364
PRY BARS	370
PICKING TOOLS	371
THREAD TOOLS	371

Tool Storage & Toolkits	373-470
TOOL TROLLEYS	374
RIGID CASES	436
CABINETS, PANELS & WORKBENCHES	448
METALLIC TOOL BOXES	456
PLASTIC BOXES & CASES	462
TEXTILE & LEATHER EQUIPMENT	463

Tools @ Height	471-490
TOOL STORAGE & LANYARDS	472
WRENCHES	475
PIPE WRENCHES	477
SOCKETS & RATCHETS	477
SCREWDRIVERS	480
PLIERS	482
CUTTING TOOLS	484
HAMMERS, PRY BARS & CHISELS	486
MEASURING & LAYOUT	488
TORQUE TOOLS	489
CLAMPING TOOLS	489
OTHER TOOLS	489
GLOVES	490

Insulated Tools	491-504
SCREWDRIVERS	492
PLIERS	498
WRENCHES	501
INSULATED SOCKETS & RATCHETS	502
SCISSORS & KNIVES	502
TWEEZERS	503
PROTECTIVE EQUIPMENT	503
TOOLSETS	503

Non Sparking Tools	505-524
WRENCHES	506
PIPE WRENCHES & VALVE TOOLS	511
SOCKETS & RATCHETS	512
SCREWDRIVERS	515
PLIERS	516
HAMMERS, PRY BARS & CHISELS	518
SCRAPERS	521
DIGGING TOOLS	523
EXTRACTORS & PULLERS	523
TORQUE TOOLS	524

Stainless Steel Tools	525-530
WRENCHES	526
SOCKETS & RATCHETS	527
SCREWDRIVERS	528
L-KEYS	528
SCREWDRIVER BITS	529
PLIERS	529
HAMMERS	530
PUNCHES & COLD CHISELS	530

Tweezers & Electronics Specialty Tools	531-536
TWEEZERS	532
SOLDERING TOOLS	535
FINE MECHANICAL	535

Measuring & Layout	537-546
MEASURING TAPES	538
MEASURING WHEELS	539
SPIRIT LEVELS	539
MARKING	542
RULES	543
SQUARES	544
PRECISION MEASURING	545

Wall Tools	547-554
SCRAPERS	548
MASONRY TOOLS	550
DRYWALL TOOLS	552

Hand Hacksaws	555-558
HAND HACKSAW FRAMES	556
HAND HACKSAW BLADES	557

Handsaws	559-568
HANDSAWS FOR CONSTRUCTION MATERIAL	560
HANDSAWS FOR WOOD	561
PRECISION HANDSAWS	565
HANDLES & SHARPENERS	566
FRET SAWS & SAWBLADES	566
COPING SAWS & SAWBLADES	567
MUSICAL SAW	567

Wood Chisels	569-574
WOODWORKING CHISELS	570
GOUGE CHISELS	572
DEMOLITION CHISELS	572
WOOD CHISEL ACCESSORIES	573

Scissors & Knives	575-586
METAL SHEARS	576
SCISSORS	579
KNIVES	580

Clamps & Vices **587-590**

CLAMPS	588
BENCH VICES	589
BENCH VICE ACCESSORIES	590

Hammers **591-598**

CLAW HAMMERS	592
NAIL PULLERS	593
ENGINEERING HAMMERS	593
CONSTRUCTION HAMMERS	594
SPECIALTY HAMMERS	596
SLEDGE HAMMERS	596
SOFT FACE HAMMERS & MALLETS	597

Tree Felling & Forestry Tools **599-602**

AXES, HATCHETS & MAULS	600
WEDGES	601

Cold Chisels & Punches **603-610**

COLD CHISELS	604
COLD CHISELS WITH GUARD	605
COLD CHISELS, REGRINDABLE	605
COLD CHISELS ACCESSORIES	606
PUNCHES	606
PUNCHES WITH 2-COMPONENT HANDLE	610
COLD CHISELS WITH 2-COMPONENT HANDLE	610

Pry Bars **611-614**

WRECKING BARS	612
---------------	-----

Planting & Cultivating Tools **615-618**

SMALL GARDEN TOOLS	616
--------------------	-----

Pruning Tools **619-638**

SECATEURS	620
FRUIT PICKING TOOLS	624
LOPPERS	624
POLE SAWS & TOP PRUNERS	626
HEDGE SHEARS	630
GRASS SHEARS	631
PRUNING KNIVES	632
SCISSORS	632
BOW SAWS	633
PRUNING SAWS	634
SPARE PARTS & ACCESSORIES	636
ACCESSORIES & MAINTENANCE	636

Air Tools Outdoor **639-642**

SECATEURS	640
-----------	-----

Lindström **643-666****Precision Cutters**

DIAGONAL CUTTERS	644
DIAGONAL CUTTERS, UNIQUE HEAD	645
OBLIQUE - END CUTTERS	645
ANGLE	646
PLASTIC CUTTERS	647
TIP CUTTER	648
OBLIQUE CUTTERS, UNIQUE HEAD	648
MICRO TIP CUTTERS	648
MULTIPURPOSE SHEARS	648
ACCESSORIES & SPARE PARTS	649

Precision Cutters for Hard materials

CARBIDE CUTTERS	649
EXTRA HARDENED DIAGONAL CUTTERS	649
PERFORMANCE SPECIFIC DIAGONAL CUTTERS	649
PERFORMANCE SPECIFIC DIAGONAL CUTTERS, UNIQUE HEAD	650

Precision Holding Pliers

FLAT NOSE	650
ROUND NOSE	650
CHAIN NOSE	651
CHAINMAILLE PLIER	651
BENT NOSE	651
SNIPE NOSE	651
SNIPE NOSE, UNIQUE HEAD	652
NEEDLE NOSE	652

Special Cutters

IC INSERTION/EXTRACTION TOOLS & IC CUTTERS	652
CUT & BEND	652
STANDOFF CUTTERS	653
CUT & FORM	653
LEADFORMERS	653

Specials Holding Pliers

IC INSERTION/EXTRACTION TOOLS & IC CUTTERS	654
LEADFORMERS	654

Shear Cutters

TAPERED HEAD	652
POINTY HEAD	653
OBLIQUE HEAD	653

Precision Screwdrivers

ESD SAFE	653
----------	-----

Wire Strippers

DIAGONAL CUTTERS	654
------------------	-----

Heavy Duty Cutters

DIAGONAL CUTTER	654
-----------------	-----

Torque Tools

TORQUE SCREWDRIVERS	654
---------------------	-----

Tweezers

TWEEZER SETS	655
CUTTING TWEEZERS	656
HIGH PRECISION TWEEZERS	656
PLASTIC REPLACEABLE TIP TWEEZERS	658
ESD SAFE ERGONOMIC TOUCH TWEEZERS	658
ECONOMY TWEEZERS	659
SMD TWEEZERS	660
COMPONENTS POSITIONING TWEEZERS	662
GENERAL PURPOSE TWEEZERS	662
SPARE PARTS & ACCESSORIES	662



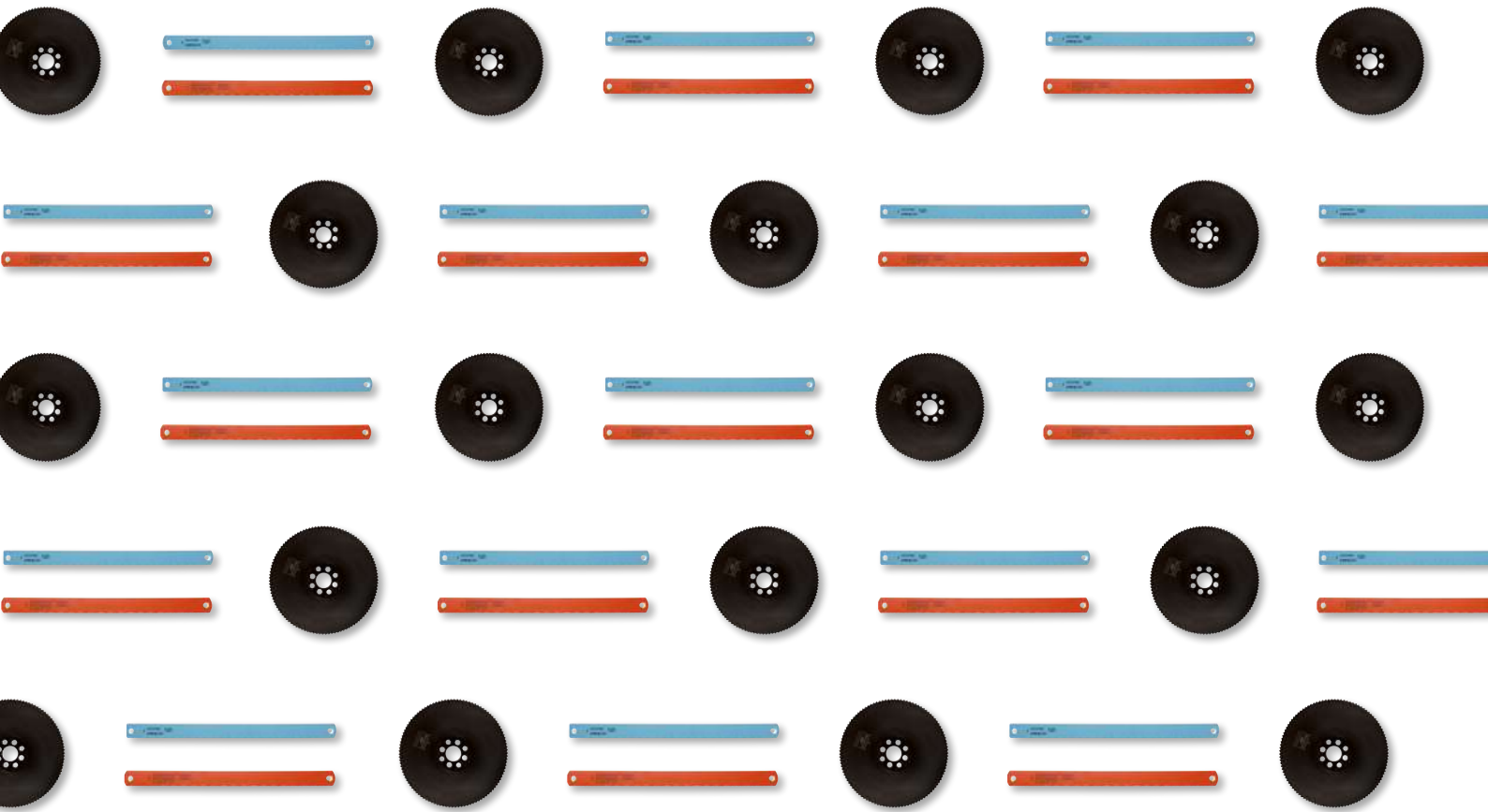

Bandsaws & Power Saws



METAL CUTTING BI-METAL BANDSAWS

Universal Bandsaw Blade for Small Workshops

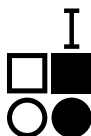

3857 Easy-Cut

13 mm	EZ	1	3857-13-0.6-EZ-S
13 mm	EZ	1	3857-13-0.6-EZ-M
13 mm	EZ	1	3857-13-0.6-EZ-L
20 mm	EZ	1	3857-20-0.9-EZ-S
20 mm	EZ	1	3857-20-0.9-EZ-M
20 mm	EZ	1	3857-20-0.9-EZ-L
27 mm	EZ	1	3857-27-0.9-EZ-S
27 mm	EZ	1	3857-27-0.9-EZ-M
27 mm	EZ	1	3857-27-0.9-EZ-L
34 mm	EZ	1	3857-34-1.1-EZ-S
34 mm	EZ	1	3857-34-1.1-EZ-M
34 mm	EZ	1	3857-34-1.1-EZ-L

General Purpose Metal Cutting Bi-Metal Bandsaw Blade for Contour and Small Machines

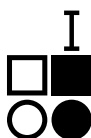

3851 Contour and small machine

6 mm	PRX	1	3851-6-0.6-10/14
6 mm	Hook	1	3851-6-0.6-H-6
6 mm	PRX	1	3851-6-0.9-10/14
6 mm	Hook	1	3851-6-0.9-H-6
10 mm	PRX	1	3851-10-0.6-10/14
10 mm	Hook	1	3851-10-0.6-H-4
10 mm	Hook	1	3851-10-0.6-H-6
10 mm	PRX	1	3851-10-0.9-10/14
10 mm	Hook	1	3851-10-0.9-H-4
10 mm	Hook	1	3851-10-0.9-H-6
10 mm	Regular	1	3851-10-0.9-R-14
13 mm	PRX	1	3851-13-0.5-10/14

13 mm	PRX	1	3851-13-0.5-14/18
13 mm	Regular	1	3851-13-0.5-R-10
13 mm	Regular	1	3851-13-0.5-R-14
13 mm	Regular	1	3851-13-0.5-R-18
13 mm	Regular	1	3851-13-0.5-R-24
13 mm	Hook	1	3851-13-0.5-H-4
13 mm	PRX	1	3851-13-0.6-10/14
13 mm	PRX	1	3851-13-0.6-5/8
13 mm	PRX	1	3851-13-0.6-6/10
13 mm	PRX	1	3851-13-0.6-8/12
13 mm	Hook	1	3851-13-0.6-H-3
13 mm	Hook	1	3851-13-0.6-H-4
13 mm	Hook	1	3851-13-0.6-H-6
13 mm	Regular	1	3851-13-0.6-R-10
13 mm	Regular	1	3851-13-0.6-R-14
13 mm	Regular	1	3851-13-0.6-R-18
13 mm	PRX	1	3851-13-0.9-10/14
13 mm	PRX	1	3851-13-0.9-6/10
13 mm	Hook	1	3851-13-0.9-H-3
13 mm	Hook	1	3851-13-0.9-H-4
13 mm	Hook	1	3851-13-0.9-H-6
13 mm	Regular	1	3851-13-0.9-R-14
13 mm	Regular	1	3851-13-0.9-R-6
20 mm	PRX	1	3851-20-0.9-10/14
20 mm	Hook	1	3851-20-0.9-H-3
20 mm	Hook	1	3851-20-0.9-H-4
20 mm	Regular	1	3851-20-0.9-R-18
20 mm	PRX	1	3851-20-0.9-4/6
20 mm	PRX	1	3851-20-0.9-5/8
20 mm	PRX	1	3851-20-0.9-6/10
20 mm	PRX	1	3851-20-0.9-8/12
27 mm	PS	1	3851-27-0.9-P-3
27 mm	PS	1	3851-27-0.9-P-4
27 mm	Regular	1	3851-27-0.9-R-6
34 mm	PS	1	3851-34-1.1-P-2
34 mm	PS	1	3851-34-1.1-P-3

Foundry Bandsaw Blade



3851 Sandflex® Cobra™ Foundry

10 mm	HA	1	3851-10-0.6-HA-4
13 mm	HA	1	3851-13-0.6-HA-4
13 mm	HA	1	3851-13-0.6-HA-6
13 mm	HA	1	3851-13-0.9-HA-4
20 mm	HA	1	3851-20-0.9-HA-3
20 mm	HA	1	3851-20-0.9-HA-4
27 mm	HA	1	3851-27-0.9-HA-4
27 mm	HA	1	3851-27-0.9-HA-3

Production Metal Cutting Bi-Metal Bandsaw Blade for High Performance



3851 Sandflex® Cobra™



27 mm	PRX	1	3851-27-0.9-2/3
27 mm	PRX	1	3851-27-0.9-3/4
27 mm	PRX	1	3851-27-0.9-4/6
27 mm	PRX	1	3851-27-0.9-5/8
27 mm	PRX	1	3851-27-0.9-6/10
27 mm	PRX	1	3851-27-0.9-8/12
27 mm	PRX	1	3851-27-0.9-10/14
34 mm	PRX	1	3851-34-1.1-2/3
34 mm	PRX	1	3851-34-1.1-3/4
34 mm	PRX	1	3851-34-1.1-4/6
34 mm	PRX	1	3851-34-1.1-5/8
34 mm	PRX	1	3851-34-1.1-6/10
41 mm	PRX	1	3851-41-1.3-1.4/2
41 mm	PRX	1	3851-41-1.3-2/3
41 mm	PRX	1	3851-41-1.3-3/4
41 mm	PRX	1	3851-41-1.3-4/6
41 mm	PRX	1	3851-41-1.3-5/8
54 mm	PRX	1	3851-54-1.3-1.4/2
54 mm	PRX	1	3851-54-1.3-2/3
54 mm	PRX	1	3851-54-1.3-3/4
54 mm	PRX	1	3851-54-1.3-4/6
54 mm	PR	1	3851-54-1.6-P-1.25
54 mm	PRX	1	3851-54-1.6-1/1.4
54 mm	PRX	1	3851-54-1.6-1.4/2
54 mm	PRX	1	3851-54-1.6-2/3
54 mm	PRX	1	3851-54-1.6-3/4
54 mm	PRX	1	3851-54-1.6-4/6
67 mm	PRX	1	3851-67-1.6-7/1
67 mm	PRX	1	3851-67-1.6-1/1.4
67 mm	PRX	1	3851-67-1.6-1.4/2
67 mm	PRX	1	3851-67-1.6-2/3
67 mm	PRX	1	3851-67-1.6-3/4
67 mm	PRX	1	3851-67-1.6-4/6
80 mm	PRX	1	3851-80-1.6-7/1
80 mm	PRX	1	3851-80-1.6-1/1.4
80 mm	PRX	1	3851-80-1.6-1.4/2

Unique Design Bandsaw Blade for Tool Steels and Hard Materials



3854-Sandflex® King Cobra™ PHX



27 mm	PHX	1	3854-27-0.9-PHX-2/3
27 mm	PHX	1	3854-27-0.9-PHX-3/4
27 mm	PHX	1	3854-27-0.9-PHX-4/6

34 mm	PHX	1	3854-34-1.1-PHX-1.4/2
34 mm	PHX	1	3854-34-1.1-PHX-2/3
34 mm	PHX	1	3854-34-1.1-PHX-3/4
34 mm	PHX	1	3854-34-1.1-PHX-4/6
41 mm	PHX	1	3854-41-1.3-PHX-1.4/2
41 mm	PHX	1	3854-41-1.3-PHX-2/3
41 mm	PHX	1	3854-41-1.3-PHX-3/4
41 mm	PHX	1	3854-41-1.3-PHX-4/6
54 mm	PHX	1	3854-54-1.3-PHX-1.4/2
54 mm	PHX	1	3854-54-1.3-PHX-2/3
54 mm	PHX	1	3854-54-1.3-PHX-3/4
54 mm	PHX	1	3854-54-1.6-PHX-7/1
54 mm	PHX	1	3854-54-1.6-PHX-1/1.4
54 mm	PHX	1	3854-54-1.6-PHX-1.4/2
54 mm	PHX	1	3854-54-1.6-PHX-2/3
54 mm	PHX	1	3854-54-1.6-PHX-3/4
67 mm	PHX	1	3854-67-1.6-PHX-7/1
67 mm	PHX	1	3854-67-1.6-PHX-1/1.4
67 mm	PHX	1	3854-67-1.6-PHX-1.4/2
67 mm	PHX	1	3854-67-1.6-PHX-2/3
80 mm	PHX	1	3854-80-1.6-PHX-7/1
80 mm	PHX	1	3854-80-1.6-PHX-1/1.4
80 mm	PHX	1	3854-80-1.6-PHX-1.4/2

Production Metal Cutting Bi-Metal Bandsaw Blade for Special and Difficult Alloys



3854-Sandflex® King Cobra™ PQ



27 mm	PQ	1	3854-27-0.9-PQ-3/4
27 mm	PQ	1	3854-27-0.9-PQ-4/6
34 mm	PQ	1	3854-34-1.1-PQ-2/3
34 mm	PQ	1	3854-34-1.1-PQ-3/4
34 mm	PQ	1	3854-34-1.1-PQ-4/6
41 mm	PQ	1	3854-41-1.3-PQ-1.4/2
41 mm	PQ	1	3854-41-1.3-PQ-2/3
41 mm	PQ	1	3854-41-1.3-PQ-3/4
41 mm	PQ	1	3854-41-1.3-PQ-4/6
54 mm	PQ	1	3854-54-1.6-PQ-9/1.2
54 mm	PQ	1	3854-54-1.6-PQ-1.4/2
54 mm	PQ	1	3854-54-1.6-PQ-2/3
54 mm	PQ	1	3854-54-1.6-PQ-3/4
54 mm	PQ	1	3854-54-1.6-PQ-4/6
67 mm	PQ	1	3854-67-1.6-PQ-9/1.2
67 mm	PQ	1	3854-67-1.6-PQ-1.4/2
67 mm	PQ	1	3854-67-1.6-PQ-2/3
80 mm	PQ	1	3854-80-1.6-PQ-9/1.2
80 mm	PQ	1	3854-80-1.6-PQ-1.4/2



Production Metal Cutting Bi-Metal Bandsaw Blade for Special and Difficult Alloys



3858 PQ P9000

Width	Grade	Quantity	Part Number
41 mm	PQ	1	3858-41-1.3-PQ-1.4/2
41 mm	PQ	1	3858-41-1.3-PQ-2/3
41 mm	PQ	1	3858-41-1.3-PQ-3/4
54 mm	PQ	1	3858-54-1.6-PQ-9/1.2
54 mm	PQ	1	3858-54-1.6-PQ-1.4/2
54 mm	PQ	1	3858-54-1.6-PQ-2/3
67 mm	PQ	1	3858-67-1.6-PQ-9/1.2
67 mm	PQ	1	3858-67-1.6-PQ-1.4/2
80 mm	PQ	1	3858-80-1.6-PQ-9/1.2

Unique Design Bandsaw Blade for Tool Steels and Hard Materials for Better Blade Life



3858 PHX P9000

Width	Grade	Quantity	Part Number
34 mm	PHX	1	3858-34-1.1-PHX-1.4/2
34 mm	PHX	1	3858-34-1.1-PHX-2/3
34 mm	PHX	1	3858-34-1.1-PHX-3/4
41 mm	PHX	1	3858-41-1.3-PHX-1.4/2
41 mm	PHX	1	3858-41-1.3-PHX-2/3
41 mm	PHX	1	3858-41-1.3-PHX-3/4
54 mm	PHX	1	3858-54-1.3-PHX-1.4/2
54 mm	PHX	1	3858-54-1.3-PHX-2/3
54 mm	PHX	1	3858-54-1.3-PHX-3/4
54 mm	PHX	1	3858-54-1.6-PHX-7/1
54 mm	PHX	1	3858-54-1.6-PHX-1/1.4
54 mm	PHX	1	3858-54-1.6-PHX-1.4/2
54 mm	PHX	1	3858-54-1.6-PHX-2/3
54 mm	PHX	1	3858-54-1.6-PHX-3/4
67 mm	PHX	1	3858-67-1.6-PHX-7/1
67 mm	PHX	1	3858-67-1.6-PHX-1/1.4
67 mm	PHX	1	3858-67-1.6-PHX-1.4/2
67 mm	PHX	1	3858-67-1.6-PHX-2/3
80 mm	PHX	1	3858-80-1.6-PHX-7/1
80 mm	PHX	1	3858-80-1.6-PHX-1/1.4
80 mm	PHX	1	3858-80-1.6-PHX-1.4/2

Sandflex® Top Fabricator Bandsaw Blades



3853 Sandflex® Top Fabricator

Width	Grade	Quantity	Part Number
20 mm	PF	1	3853-20-0.9-5/7-VS
20 mm	PF	1	3853-20-0.9-8/11-VS
27 mm	PF	1	3853-27-0.9-3/4
27 mm	PF	1	3853-27-0.9-4/6
27 mm	PF	1	3853-27-0.9-5/8
27 mm	PF	1	3853-27-0.9-8/11-VS
27 mm	PF	1	3853-27-0.9-8/11-VS
34 mm	PF	1	3853-34-1.1-2/3
34 mm	PF	1	3853-34-1.1-3/4
34 mm	PF	1	3853-34-1.1-4/6
34 mm	PF	1	3853-34-1.1-5/8
34 mm	PF	1	3853-34-1.1-5/7-VS
34 mm	PF	1	3853-34-1.1-8/11-VS
41 mm	PF	1	3853-41-1.3-2/3
41 mm	PF-W	1	3853-41-1.3-2/3-W
41 mm	PF	1	3853-41-1.3-3/4
41 mm	PF-W	1	3853-41-1.3-3/4-W
41 mm	PF	1	3853-41-1.3-4/6
41 mm	PF	1	3853-41-1.3-5/8
41 mm	PF	1	3853-41-1.3-5/7-VS
54 mm	PF	1	3853-54-1.3-3/4
54 mm	PF	1	3853-54-1.3-3/4-W
54 mm	PF	1	3853-54-1.3-5/8
54 mm	PF	1	3853-54-1.6-2/3
54 mm	PF-W	1	3853-54-1.6-2/3-W
54 mm	PF	1	3853-54-1.6-3/4
54 mm	PF-W	1	3853-54-1.6-3/4-W
54 mm	PF	1	3853-54-1.6-4/6
67 mm	PF	1	3853-67-1.6-2/3
67 mm	PF-W	1	3853-67-1.6-2/3-W
67 mm	PF	1	3853-67-1.6-3/4
67 mm	PF-W	1	3853-67-1.6-3/4-W
67 mm	PF-W	1	3853-67-1.6-5/8-W

Sandflex® Top Fabricator Coated Bandsaw Blades



3853 Sandflex® Top Fabricator Coated

Width	Grade	Quantity	Part Number
41 mm	PF	1	3853-41-1.3-2/3-WS
41 mm	PF	1	3853-41-1.3-3/4-WS
54 mm	PF	1	3853-54-1.6-2/3-WS
54 mm	PF	1	3853-54-1.6-3/4-WS
67 mm	PF	1	3853-67-1.6-2/3-WS
67 mm	PF	1	3853-67-1.6-3/4-WS

METAL CUTTING TRI-METAL BANDSAWS

Extreme Easy-Cut Carbide Bandsaw Blades

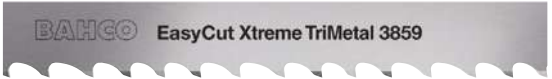

3859 Carbide Easy-Cut EZX

27 mm	EZX	1	3859-27-0.9-EZX-3/4
27 mm	EZX	1	3859-27-0.9-EZX-4/6
34 mm	EZX	1	3859-34-1.1-EZX-2/3
34 mm	EZX	1	3859-34-1.1-EZX-3/4
34 mm	EZX	1	3859-34-1.1-EZX-4/6
41 mm	EZX	1	3859-41-1.3-EZX-1.4/2
41 mm	EZX	1	3859-41-1.3-EZX-2/3
41 mm	EZX	1	3859-41-1.3-EZX-3/4
41 mm	EZX	1	3859-41-1.3-EZX-4/6
54 mm	EZX	1	3859-54-1.6-EZX-1.4/2
54 mm	EZX	1	3859-54-1.6-EZX-1/1.25
54 mm	EZX	1	3859-54-1.6-EZX-2/3
54 mm	EZX	1	3859-54-1.6-EZX-3/4
54 mm	EZX	1	3859-54-1.6-EZX-4/6
67 mm	EZX	1	3859-67-1.6-EZX-7/1
67 mm	EZX	1	3859-67-1.6-EZX-1.4/2
67 mm	EZX	1	3859-67-1.6-EZX-1/1.25
67 mm	EZX	1	3859-67-1.6-EZX-2/3
80 mm	EZX	1	3859-80-1.6-EZX-7/1
80 mm	EZX	1	3859-80-1.6-EZX-1.4/2
80 mm	EZX	1	3859-80-1.6-EZX-1/1.25

METAL CUTTING CARBIDE BANDSAWS

Foundry Bandsaw Blade



3869 Carbide Triple Set®

13 mm	TS	1	3869-13-0.9-TS-3
20 mm	TS	1	3869-20-0.9-TS-3
20 mm	TS	1	3869-20-0.9-TS-4
27 mm	TS	1	3869-27-0.9-TS-3
27 mm	TS	1	3869-27-0.9-TS-4
34 mm	TS	1	3869-34-1.1-TS-2
34 mm	TS	1	3869-34-1.1-TS-3

Versatile Carbide Bandsaw Blade

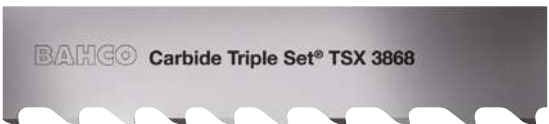

3868 Carbide Triple Set® TSX

27 mm	TSX	1	3868-27-0.9-TSX-3/4
34 mm	TSX	1	3868-34-1.1-TSX-2
34 mm	TSX	1	3868-34-1.1-TSX-2/3
34 mm	TSX	1	3868-34-1.1-TSX-3/4
41 mm	TSX	1	3868-41-1.3-TSX-1.4/2
41 mm	TSX	1	3868-41-1.3-TSX-1.6
41 mm	TSX	1	3868-41-1.3-TSX-2
41 mm	TSX	1	3868-41-1.3-TSX-2/3
41 mm	TSX	1	3868-41-1.3-TSX-3/4
54 mm	TSX	1	3868-54-1.3-TSX-1.4/2
54 mm	TSX	1	3868-54-1.3-TSX-2/3
54 mm	TSX	1	3868-54-1.6-TSX-1/1.25
54 mm	TSX	1	3868-54-1.6-TSX-1.4/2
54 mm	TSX	1	3868-54-1.6-TSX-1.6
54 mm	TSX	1	3868-54-1.6-TSX-2/3
54 mm	TSX	1	3868-54-1.6-TSX-3/4
67 mm	TSX	1	3868-67-1.6-TSX-7/1
67 mm	TSX	1	3868-67-1.6-TSX-1/1.25
67 mm	TSX	1	3868-67-1.6-TSX-1.4/2
67 mm	TSX	1	3868-67-1.6-TSX-2/3
80 mm	TSX	1	3868-80-1.1-TSX-3/4
80 mm	TSX	1	3868-80-1.6-TSX-7/1
80 mm	TSX	1	3868-80-1.6-TSX-1/1.25
80 mm	TSX	1	3868-80-1.6-TSX-1.4/2
80 mm	TSX	1	3868-80-1.6-TSX-2/3

Versatile Honed Carbide Bandsaw Blade



3868 Carbide Triple Set® TSS

27 mm	TSS	1	3868-27-0.9-TSS-3/4
34 mm	TSS	1	3868-34-1.1-TSS-2/3
34 mm	TSS	1	3868-34-1.1-TSS-3/4
41 mm	TSS	1	3868-41-1.3-TSS-1.4/2
41 mm	TSS	1	3868-41-1.3-TSS-2/3
54 mm	TSS	1	3868-54-1.6-TSS-1/1.25
54 mm	TSS	1	3868-54-1.6-TSS-1.4/2
54 mm	TSS	1	3868-54-1.6-TSS-2/3
67 mm	TSS	1	3868-67-1.6-TSS-7/1
67 mm	TSS	1	3868-67-1.6-TSS-1/1.25
67 mm	TSS	1	3868-67-1.6-TSS-1.4/2
67 mm	TSS	1	3868-67-1.6-TSS-2/3
80 mm	TSS	1	3868-80-1.6-TSS-7/1
80 mm	TSS	1	3868-80-1.6-TSS-1.4/2
80 mm	TSS	1	3868-80-1.6-TSS-2/3



Advanced Carbide Bandsaw Blade



3881 Carbide Multi Set THQ

34 mm	THQ	1	3881-34-1.1-THQ-2/3
41 mm	THQ	1	3881-41-1.3-THQ-1.4/2
41 mm	THQ	1	3881-41-1.3-THQ-2/3
54 mm	THQ	1	3881-54-1.6-THQ-1.4/2
54 mm	THQ	1	3881-54-1.6-THQ-1/1.25
54 mm	THQ	1	3881-54-1.6-THQ-2/3
67 mm	THQ	1	3881-67-1.6-THQ-1/1.25
67 mm	THQ	1	3881-67-1.6-THQ-1.4/2
67 mm	THQ	1	3881-67-1.6-THQ-2/3
80 mm	THQ	1	3881-80-1.6-THQ-7/1
80 mm	THQ	1	3881-80-1.6-THQ-1/1.25
80 mm	THQ	1	3881-80-1.6-THQ-1.4/2
80 mm	THQ	1	3881-80-1.6-THQ-2/3

Advanced Honed Carbide Bandsaw Blade



3881 Carbide Multi Set THS

41 mm	THS	1	3881-41-1.3-THS-1.4/2
54 mm	THS	1	3881-54-1.6-THS-1/1.25
54 mm	THS	1	3881-54-1.6-THS-1.4/2
67 mm	THS	1	3881-67-1.6-THS-1/1.25
67 mm	THS	1	3881-67-1.6-THS-1.4/2
67 mm	THS	1	3881-67-1.6-THS-2/3
80 mm	THS	1	3881-80-1.6-THS-7/1
80 mm	THS	1	3881-80-1.6-THS-1.4/2
80 mm	THS	1	3881-80-1.6-THS-2/3
100 mm	THS	1	3881-100-1.6-THS-7/1

Most Advanced Carbide Bandsaw Blade



3860 Unset Carbide TMC

41 mm	TMC	1	3860-41-1.3-TMC-1.4/2
41 mm	TMC	1	3860-41-1.3-TMC-2/3
54 mm	TMC	1	3860-54-1.3-TMC-1.4/2

54 mm	TMC	1	3860-54-1.3-TMC-2/3
54 mm	TMC	1	3860-54-1.6-TMC-7/1
54 mm	TMC	1	3860-54-1.6-TMC-1/1.25
54 mm	TMC	1	3860-54-1.6-TMC-1.4/2
54 mm	TMC	1	3860-54-1.6-TMC-2/3
67 mm	TMC	1	3860-67-1.6-TMC-1/1.25
67 mm	TMC	1	3860-67-1.6-TMC-1.4/2
67 mm	TMC	1	3860-67-1.6-TMC-2/3
80 mm	TMC	1	3860-80-1.1-TMC-1.4/2
80 mm	TMC	1	3860-80-1.6-TMC-7/1
80 mm	TMC	1	3860-80-1.6-TMC-1/1.25
80 mm	TMC	1	3860-80-1.6-TMC-1.4/2
80 mm	TMC	1	3860-80-1.6-TMC-2/3
100 mm	TMC	1	3860-100-1.1-TMC-1.4/2

Versatile Carbide Bandsaw Blade



3860 Unset Carbide TCD

27 mm	TCD	1	3860-27-0.9-TCD-3
27 mm	TCD	1	3860-27-0.9-TCD-3/4
34 mm	TCD	1	3860-34-1.1-TCD-2/3
34 mm	TCD	1	3860-34-1.1-TCD-3/4
34 mm	TCD	1	3860-34-1.1-TCD-3/4-W
41 mm	TCD	1	3860-41-1.3-TCD-1.4/2
41 mm	TCD	1	3860-41-1.3-TCD-1.9/2.1
41 mm	TCD	1	3860-41-1.3-TCD-2/3
41 mm	TCD	1	3860-41-1.3-TCD-3/4
54 mm	TCD	1	3860-54-1.6-TCD-1.4/2
54 mm	TCD	1	3860-54-1.6-TCD-1.9/2.1
54 mm	TCD	1	3860-54-1.6-TCD-2/3
54 mm	TCD	1	3860-54-1.6-TCD-3/4
67 mm	TCD	1	3860-67-1.6-TCD-1.4/2
67 mm	TCD	1	3860-67-1.6-TCD-1/1.25
80 mm	TCD	1	3860-80-1.6-TCD-5/0.8

Bandsaw Blade for Induction Hardened Bars



3860 Unset Carbide TCZ

27 mm	TCZ	1	3860-27-0.9-TCZ-3/4
34 mm	TCZ	1	3860-34-1.1-TCZ-2/3
34 mm	TCZ	1	3860-34-1.1-TCZ-3/4
41 mm	TCZ	1	3860-41-1.3-TCZ-2/3
41 mm	TCZ	1	3860-41-1.3-TCZ-3/4

Coated TMC Multi Chip Unset Carbide Bandsaw Blades



3860 Unset Carbide TMC Coated

Width	Chip	Material	Quantity	Part Number
54 mm	TMC	1	3860-54-1.6-TMC-1/1.25S	
54 mm	TMC	1	3860-54-1.6-TMC-1.4/2S	
54 mm	TMC	1	3860-54-1.6-TMC-2/3S	
67 mm	TMC	1	3860-67-1.6-TMC-1/1.25S	
67 mm	TMC	1	3860-67-1.6-TMC-1.4/2S	

WOOD CUTTING BANDSAW

Bi-metal Bandsaw Blade for Longer Life



3861 Sandcut Bi-metal

Width	Chip	Material	Quantity	Part Number
4	Hook	1	3861-20-0.6-H-4	
1.33	Hook	1	3861-27-0.9-H-1.33	
1.15	Hook	1	3861-34-0.9-H-1.15	
1.15	Hook	1	3861-34-1.1-H-1.15	
1.15	Hook	1	3861-41-1.1-H-1.15	
1.15	Hook	1	3861-54-1.1-H-1.15	

Standard Bandsaw Blade



3862 Sandcut Solid

Width	Chip	Material	Quantity	Part Number
1.15	Hook	1	3862-33-0.9-H-1.15	
1.15	Hook	1	3862-33-1.1-H-1.15	
1.15	Hook	1	3862-40-1.1-H-1.15	

INSULATION CUTTING BANDSAWS

Sandflex® Twin Tip Insulation Bandsaw Blades



3852 Sandflex® Twin Tip Insulation

Width	Chip	Material	Quantity	Part Number
27 mm	INS	1	3852-27-0.9-INS-3	
34 mm	INS	1	3852-34-1.1-INS-3	

HSS CIRCULAR SAWBLADES

HSS Circular Saw Blades with 32-1 Bore



3815-32-1

Width	Chip	Material	Quantity	Part Number
200 mm	BW3	1	3815-200-2,0-32-1-03BW	
200 mm	BW4	1	3815-200-2,0-32-1-04BW	
225 mm	BW3	1	3815-225-2,0-32-1-03BW	
225 mm	BW4	1	3815-225-2,0-32-1-04BW	
225 mm	BW5	1	3815-225-2,0-32-1-05BW	
225 mm	C6	1	3815-225-2,0-32-1-06C	
250 mm	BW3	1	3815-250-2,0-32-1-03BW	
250 mm	BW4	1	3815-250-2,0-32-1-04BW	
250 mm	BW5	1	3815-250-2,0-32-1-05BW	
250 mm	C6	1	3815-250-2,0-32-1-06C	
275 mm	BW4	1	3815-275-2,5-32-1-04BW	
275 mm	BW5	1	3815-275-2,5-32-1-05BW	
275 mm	C6	1	3815-275-2,5-32-1-06C	
275 mm	C8	1	3815-275-2,5-32-1-08C	
300 mm	BW4	1	3815-300-2,5-32-1-04BW	
300 mm	BW5	1	3815-300-2,5-32-1-05BW	
300 mm	C5	1	3815-300-2,5-32-1-05C	
300 mm	C6	1	3815-300-2,5-32-1-06C	
300 mm	C8	1	3815-300-2,5-32-1-08C	
315 mm	BW4	1	3815-315-2,5-32-1-04BW	
315 mm	BW5	1	3815-315-2,5-32-1-05BW	
315 mm	C6	1	3815-315-2,5-32-1-06C	
315 mm	C8	1	3815-315-2,5-32-1-08C	
350 mm	BW4	1	3815-350-2,5-32-1-04BW	
350 mm	C6	1	3815-350-2,5-32-1-06C	



HSS Circular Saw Blades with 40-2 Bore



3815-40-2

Ø	V		
250 mm	BW3	1	3815-250-2.0-40-2-03BW
250 mm	BW4	1	3815-250-2.0-40-2-04BW
250 mm	BW5	1	3815-250-2.0-40-2-05BW
275 mm	BW3	1	3815-275-2.5-40-2-03BW
275 mm	BW4	1	3815-275-2.5-40-2-04BW
275 mm	BW5	1	3815-275-2.5-40-2-05BW
275 mm	C6	1	3815-275-2.5-40-2-06C
275 mm	C8	1	3815-275-2.5-40-2-08C
315 mm	BW4	1	3815-315-2.5-40-2-04BW
315 mm	BW5	1	3815-315-2.5-40-2-05BW
315 mm	C6	1	3815-315-3.0-40-2-06C

HSS Circular Saw Blades with 50-4 Bore



3815-50-4

Ø	V		
370 mm	C8	1	3815-370-3.0-50-4-08C
370 mm	C10	1	3815-370-3.0-50-4-10C
400 mm	C10	1	3815-400-3.5-50-4-10C

POWER HACKSAW BLADES

Sandflex® Bi-Metal Power Hacksaw Blades



3809



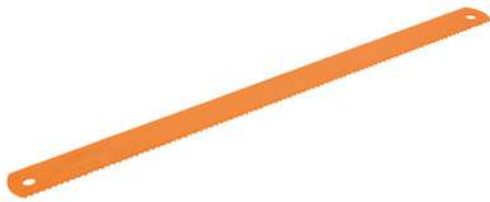

Ø	L		
10	300 mm	10	3809-300-25-1.25-10
14	300 mm	10	3809-300-25-1.25-14
6	300 mm	10	3809-300-32-1.60-6

Ø	L		
10	300 mm	10	3809-300-32-1.60-10
6	350 mm	10	3809-350-25-1.25-6
10	350 mm	10	3809-350-25-1.25-10
14	350 mm	10	3809-350-25-1.25-14
4	350 mm	10	3809-350-32-1.60-4
6	350 mm	10	3809-350-32-1.60-6
8	350 mm	10	3809-350-32-1.60-8
10	350 mm	10	3809-350-32-1.60-10
14	350 mm	10	3809-350-32-1.60-14
4	350 mm	10	3809-350-32-2.00-4
6	350 mm	10	3809-350-32-2.00-6
10	350 mm	10	3809-350-32-2.00-10
6	350 mm	10	3809-350-38-2.00-6
10	350 mm	10	3809-350-38-2.00-10
10	400 mm	10	3809-400-25-1.25-10
4	400 mm	10	3809-400-32-1.60-4
6	400 mm	10	3809-400-32-1.60-6
8	400 mm	10	3809-400-32-1.60-8
10	400 mm	10	3809-400-32-1.60-10
14	400 mm	10	3809-400-32-1.60-14
4	400 mm	10	3809-400-32-2.00-4
6	400 mm	10	3809-400-32-2.00-6
8	400 mm	10	3809-400-32-2.00-8
10	400 mm	10	3809-400-32-2.00-10
4	400 mm	10	3809-400-38-2.00-4
6	400 mm	10	3809-400-38-2.00-6
10	400 mm	10	3809-400-38-2.00-10
6	425 mm	10	3809-425-32-1.60-6
10	425 mm	10	3809-425-32-1.60-10
4	450 mm	10	3809-450-32-1.60-4
6	450 mm	10	3809-450-32-1.60-6
10	450 mm	10	3809-450-32-1.60-10
14	450 mm	10	3809-450-32-1.60-14
4	450 mm	10	3809-450-32-2.00-4
6	450 mm	10	3809-450-32-2.00-6
10	450 mm	10	3809-450-32-2.00-10
4	450 mm	10	3809-450-38-2.00-4
6	450 mm	10	3809-450-38-2.00-6
8	450 mm	10	3809-450-38-2.00-8
10	450 mm	10	3809-450-38-2.00-10
4	450 mm	10	3809-450-45-2.25-4
6	450 mm	10	3809-450-45-2.25-6
6	475 mm	10	3809-475-45-2.25-6
4	500 mm	10	3809-500-38-2.00-4
6	500 mm	10	3809-500-38-2.00-6
10	500 mm	10	3809-500-38-2.00-10
4	500 mm	10	3809-500-45-2.25-4
6	500 mm	10	3809-500-45-2.25-6
4	500 mm	10	3809-500-50-2.50-4
6	500 mm	10	3809-500-50-2.50-6
8	500 mm	10	3809-500-50-2.50-8
6	525 mm	10	3809-525-38-2.00-6
10	525 mm	10	3809-525-38-2.00-10
4	525 mm	10	3809-525-45-2.25-4
6	525 mm	10	3809-525-45-2.25-6
4	550 mm	10	3809-550-45-2.25-4
6	550 mm	10	3809-550-45-2.25-6
4	550 mm	10	3809-550-50-2.50-4
6	550 mm	10	3809-550-50-2.50-6
4	575 mm	10	3809-575-45-2.25-4
3	575 mm	10	3809-575-50-2.50-3
4	575 mm	10	3809-575-50-2.50-4
6	575 mm	10	3809-575-50-2.50-6
6	600 mm	10	3809-600-38-2.00-6
4	600 mm	10	3809-600-45-2.25-4
6	600 mm	10	3809-600-45-2.25-6
3	600 mm	10	3809-600-50-2.50-3
4	600 mm	10	3809-600-50-2.50-4
6	600 mm	10	3809-600-50-2.50-6
4	650 mm	5	3809-650-50-2.50-4
6	650 mm	5	3809-650-50-2.50-6
4	700 mm	5	3809-700-50-2.50-4
6	700 mm	5	3809-700-50-2.50-6
4	750 mm	5	3809-750-50-2.50-4
6	750 mm	5	3809-750-50-2.50-6

Sandflex® Bi-metal Power Hacksaw Blades for KASTO machines







3809 KA

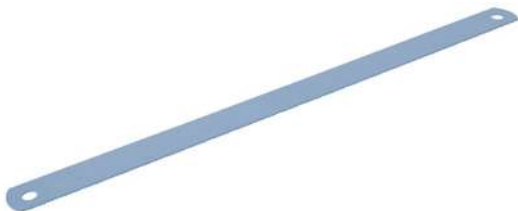



			
6	400 mm	10	3809-400-32-2.00-6-KA
4	450 mm	10	3809-450-38-2.00-4-KA
6	450 mm	10	3809-450-38-2.00-6-KA
10	450 mm	10	3809-450-38-2.00-10-KA
6	500 mm	10	3809-500-45-2.25-6-KA
4	500 mm	10	3809-500-50-2.50-4-KA
6	500 mm	10	3809-500-50-2.50-6-KA
4	550 mm	10	3809-550-50-2.50-4-KA
6	550 mm	10	3809-550-50-2.50-6-KA
3	575 mm	10	3809-575-50-2.50-3-KA
4	575 mm	10	3809-575-50-2.50-4-KA
6	575 mm	10	3809-575-50-2.50-6-KA
10	575 mm	10	3809-575-50-2.50-10-KA
4	600 mm	10	3809-600-50-2.50-4-KA
6	600 mm	10	3809-600-50-2.50-6-KA
3	650 mm	5	3809-650-50-2.50-3-KA
4	650 mm	5	3809-650-50-2.50-4-KA
6	650 mm	5	3809-650-50-2.50-6-KA
3	700 mm	5	3809-700-50-2.50-3-KA
4	700 mm	5	3809-700-50-2.50-4-KA
6	700 mm	5	3809-700-50-2.50-6-KA

HSS Power Hacksaw Blades



3802



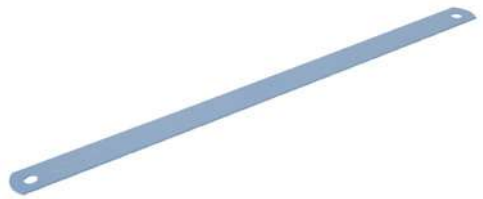

			
6	300 mm	10	3802-300-25-1.25-6
10	300 mm	10	3802-300-25-1.25-10
14	300 mm	10	3802-300-25-1.25-14
6	300 mm	10	3802-300-32-1.60-6
10	300 mm	10	3802-300-32-1.60-10
6	350 mm	10	3802-350-25-1.25-6
10	350 mm	10	3802-350-25-1.25-10
14	350 mm	10	3802-350-25-1.25-14
4	350 mm	10	3802-350-32-1.60-4
6	350 mm	10	3802-350-32-1.60-6
8	350 mm	10	3802-350-32-1.60-8
10	350 mm	10	3802-350-32-1.60-10
14	350 mm	10	3802-350-32-1.60-14
6	400 mm	10	3802-400-25-1.25-6
10	400 mm	10	3802-400-25-1.25-10
14	400 mm	10	3802-400-25-1.25-14
4	400 mm	10	3802-400-32-1.60-4
6	400 mm	10	3802-400-32-1.60-6
8	400 mm	10	3802-400-32-1.60-8
10	400 mm	10	3802-400-32-1.60-10
14	400 mm	10	3802-400-32-1.60-14
4	400 mm	10	3802-400-38-2.00-4

			
6	400 mm	10	3802-400-38-2.00-6
10	400 mm	10	3802-400-38-2.00-10
6	425 mm	10	3802-425-32-1.60-6
10	425 mm	10	3802-425-32-1.60-10
4	450 mm	10	3802-450-32-1.60-4
6	450 mm	10	3802-450-32-1.60-6
10	450 mm	10	3802-450-32-1.60-10
14	450 mm	10	3802-450-32-1.60-14
4	450 mm	10	3802-450-38-2.00-4
6	450 mm	10	3802-450-38-2.00-6
8	450 mm	10	3802-450-38-2.00-8
10	450 mm	10	3802-450-38-2.00-10
8	475 mm	10	3802-475-38-2.00-8
4	500 mm	10	3802-500-38-2.00-4
6	500 mm	10	3802-500-38-2.00-6
8	500 mm	10	3802-500-38-2.00-8
10	500 mm	10	3802-500-38-2.00-10
10	500 mm	10	3802-500-45-2.25-10
4	500 mm	10	3802-500-50-2.50-4
6	500 mm	10	3802-500-50-2.50-6
6	525 mm	10	3802-525-38-2.00-6
8	525 mm	10	3802-525-38-2.00-8
10	525 mm	10	3802-525-38-2.00-10
6	550 mm	10	3802-550-38-2.00-6
4	550 mm	10	3802-550-50-2.50-4
6	550 mm	10	3802-550-50-2.50-6
8	550 mm	5	3802-550-50-2.50-8
10	550 mm	10	3802-550-50-2.50-10
4	575 mm	10	3802-575-50-2.50-4
6	575 mm	10	3802-575-50-2.50-6
4	600 mm	10	3802-600-50-2.50-4
6	600 mm	10	3802-600-50-2.50-6
8	600 mm	10	3802-600-50-2.50-8
4	650 mm	5	3802-650-50-2.50-4
6	650 mm	5	3802-650-50-2.50-6
3	700 mm	5	3802-700-50-2.50-3
4	700 mm	5	3802-700-50-2.50-4
6	700 mm	5	3802-700-50-2.50-6
4	750 mm	5	3802-750-50-2.50-4
6	750 mm	5	3802-750-50-2.50-6

HSS Power Hacksaw Blades for KASTO machines



3802 KA

			
4	450 mm	10	3802-450-38-2.00-4-KA
6	450 mm	10	3802-450-38-2.00-6-KA
8	450 mm	10	3802-450-38-2.00-8-KA
10	450 mm	10	3802-450-38-2.00-10-KA
4	500 mm	10	3802-500-50-2.50-4-KA
6	500 mm	10	3802-500-50-2.50-6-KA
4	550 mm	10	3802-550-50-2.50-4-KA
8	550 mm	10	3802-550-50-2.50-8-KA
3	575 mm	10	3802-575-50-2.50-3-KA
4	575 mm	10	3802-575-50-2.50-4-KA
6	575 mm	10	3802-575-50-2.50-6-KA
4	650 mm	5	3802-650-50-2.50-4-KA
6	650 mm	5	3802-650-50-2.50-6-KA
2	700 mm	5	3802-700-50-2.50-2-KA
4	700 mm	5	3802-700-50-2.50-4-KA
6	700 mm	5	3802-700-50-2.50-6-KA



BANDSAW ACCESSORIES

Chip Brushes for Cleaning Bandsaw Blade



3870-BRUSH



60 mm	4	3870-BRUSH-60-6
80 mm	4	3870-BRUSH-80-6
80 mm	4	3870-BRUSH-80-8
80 mm	4	3870-BRUSH-80-10
100 mm	4	3870-BRUSH-100-10
100 mm	4	3870-BRUSH-100-12
100 mm	4	3870-BRUSH-100-10-HEX
100 mm	1	3870-BRUSH-100-13

Tachometers for Bandsaw



3870-TACHO



400 g	1	3870-TACHO METER
-------	---	------------------

Tension Meters for Bandsaw



3870-TENSION



680 g	1	3870-TENSION METER
-------	---	--------------------

Refractometers for Bandsaw



3870-REFR



260 g	1	3870-REFRACTOMETER
-------	---	--------------------

Steel Wedges 75 mm



3870-WEDGE



60 g	1	3870-WEDGE-3
------	---	--------------

Bandsaw Tension Adjusting Wheel



3870-Wheel



0.7790 kg	1	3870-WHEEL
-----------	---	------------



Files



ENGINEERING FILES

Engineering Flat Hand Files Bastard/
Second/Smooth Cut Unhandled



1-100...-0

Length	Type of cut	Quantity	Part No.
100 mm	1	10	1-100-04-1-0
100 mm	2	10	1-100-04-2-0
100 mm	3	10	1-100-04-3-0
150 mm	1	10	1-100-06-1-0
150 mm	2	10	1-100-06-2-0
150 mm	3	10	1-100-06-3-0
200 mm	1	10	1-100-08-1-0
200 mm	2	10	1-100-08-2-0
200 mm	3	10	1-100-08-3-0
250 mm	1	10	1-100-10-1-0
250 mm	2	10	1-100-10-2-0
250 mm	3	10	1-100-10-3-0
300 mm	1	5	1-100-12-1-0
300 mm	2	5	1-100-12-2-0
300 mm	3	5	1-100-12-3-0
350 mm	1	5	1-100-14-1-0
350 mm	2	5	1-100-14-2-0

Type of cut: 1 = Bastard, 2 = Second, 3 = Smooth

ERGO™ Engineering Flat Hand Files
Bastard/Second/Smooth Cut



ergo



1-100...-2

Length	Type of cut	Quantity	Part No.
100 mm	1	5	1-100-04-1-2
100 mm	2	5	1-100-04-2-2
150 mm	1	5	1-100-06-1-2
150 mm	2	5	1-100-06-2-2
150 mm	3	5	1-100-06-3-2
200 mm	1	5	1-100-08-1-2
200 mm	2	5	1-100-08-2-2
200 mm	3	5	1-100-08-3-2
250 mm	1	5	1-100-10-1-2
250 mm	2	5	1-100-10-2-2
250 mm	3	5	1-100-10-3-2
300 mm	1	5	1-100-12-1-2
300 mm	2	5	1-100-12-2-2
300 mm	3	5	1-100-12-3-2

Type of cut: 1 = Bastard, 2 = Second, 3 = Smooth

Engineering Pillar Files Bastard/Second/
Smooth Cut Unhandled



1-102

Length	Type of cut	Quantity	Part No.
150 mm	2	10	1-102-06-2-0
150 mm	3	10	1-102-06-3-0
200 mm	1	10	1-102-08-1-0
200 mm	2	10	1-102-08-2-0
200 mm	3	10	1-102-08-3-0

Type of cut: 1 = Bastard, 2 = Second, 3 = Smooth

Engineering Lathe Files Second/Smooth
Cut Unhandled



1-104

Length	Type of cut	Quantity	Part No.
250 mm	2	10	1-104-10-2-0
250 mm	3	10	1-104-10-3-0
300 mm	2	5	1-104-12-2-0
300 mm	3	5	1-104-12-3-0
350 mm	3	5	1-104-14-3-0

Type of cut: 1 = Bastard, 2 = Second, 3 = Smooth

Engineering Oberg Cut Flat Hand Files
Bastard Cut Unhandled



1-106...-0

Length	Type of cut	Quantity	Part No.
200 mm	1	10	1-106-08-1-0
250 mm	1	10	1-106-10-1-0
300 mm	1	5	1-106-12-1-0

Type of cut: 1 = Bastard, 2 = Second, 3 = Smooth

ERGO™ Engineering Oberg Cut Flat Hand
Files Bastard Cut



ergo



1-106...-2

Length	Type of cut	Quantity	Part No.
200 mm	1	5	1-106-08-1-2
250 mm	1	5	1-106-10-1-2
300 mm	1	5	1-106-12-1-2

Type of cut: 1 = Bastard, 2 = Second, 3 = Smooth

Engineering Flat Files with Tapered Edge
Bastard/Second/Smooth Cut Unhandled



1-110...-0

Length	Type of cut	Quantity	Part No.
100 mm	1	10	1-110-04-1-0
100 mm	2	10	1-110-04-2-0
100 mm	2	10	1-110-04-3-0
150 mm	1	10	1-110-06-1-0
150 mm	2	10	1-110-06-2-0
150 mm	3	10	1-110-06-3-0
200 mm	1	10	1-110-08-1-0
200 mm	2	10	1-110-08-2-0
200 mm	2	10	1-110-08-3-0
250 mm	1	10	1-110-10-1-0
250 mm	2	10	1-110-10-2-0
250 mm	3	10	1-110-10-3-0
300 mm	1	5	1-110-12-1-0
300 mm	2	5	1-110-12-2-0
300 mm	3	5	1-110-12-3-0
350 mm	1	5	1-110-14-1-0

Type of cut: 1 = Bastard, 2 = Second, 3 = Smooth

ERGO™ Engineering Tapered Edge Flat File Bastard/Second/Smooth Cut



1-110...-2



150 mm	1	5	1-110-06-1-2
150 mm	2	5	1-110-06-2-2
150 mm	3	5	1-110-06-3-2
200 mm	1	5	1-110-08-1-2
200 mm	2	5	1-110-08-2-2
200 mm	3	5	1-110-08-3-2
250 mm	1	5	1-110-10-1-2
250 mm	2	5	1-110-10-2-2
250 mm	3	5	1-110-10-3-2
300 mm	1	5	1-110-12-1-2
300 mm	2	5	1-110-12-2-2
300 mm	3	5	1-110-12-3-2

Type of cut: 1 = Bastard, 2 = Second, 3 = Smooth

Engineering Warding Flat Hand Files Bastard/Second/Smooth Cut Unhandled



1-111...-0



100 mm	1	10	1-111-04-1-0
100 mm	2	10	1-111-04-2-0
100 mm	3	10	1-111-04-3-0
150 mm	1	10	1-111-06-1-0
150 mm	2	10	1-111-06-2-0
150 mm	3	10	1-111-06-3-0
200 mm	1	10	1-111-08-1-0
200 mm	2	10	1-111-08-2-0

Type of cut: 1 = Bastard, 2 = Second, 3 = Smooth

ERGO™ Engineering Warding Flat Files Second Cut



1-111...-2



150 mm	2	5	1-111-06-2-2
--------	---	---	--------------

Type of cut: 1 = Bastard, 2 = Second, 3 = Smooth

Engineering Flat Contact Files Smooth Cut Unhandled



1-115



110 mm	3	10	1-115-11-3-1
--------	---	----	--------------

Engineering Mill Files with 2 Flat Edges Bastard/Second Cut Unhandled



1-143...-0



100 mm	1	10	1-143-04-1-0
150 mm	1	10	1-143-06-1-0
200 mm	1	10	1-143-08-1-0
250 mm	1	10	1-143-10-1-0
300 mm	1	5	1-143-12-1-0

Type of cut: 1 = Bastard, 2 = Second, 3 = Smooth

ERGO™ Engineering Mill Files with 2 Flat Edges Bastard/Second Cut



1-143...-2



150 mm	1	5	1-143-06-1-2
200 mm	1	5	1-143-08-1-2
250 mm	1	5	1-143-10-1-2
300 mm	1	5	1-143-12-1-2

Type of cut: 1 = Bastard, 2 = Second, 3 = Smooth

ERGO™ Engineering Diagonal Files Second Cut



1-320 ...-2



200 mm	2	5	1-320-08-2-2
250 mm	2	5	1-320-10-2-2

Type of cut: 1 = Bastard, 2 = Second, 3 = Smooth

Engineering Diagonal Files Second Cut Unhandled



1-320...-0



200 mm	2	10	1-320-08-2-0
250 mm	2	10	1-320-10-2-0
300 mm	2	5	1-320-12-2-0

Type of cut: 1 = Bastard, 2 = Second, 3 = Smooth



Engineering Half-Round Files Bastard/
Second/Smooth Cut Unhandled



1-210...-0

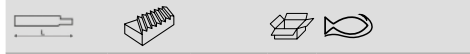

100 mm	1	10	1-210-04-1-0
100 mm	2	10	1-210-04-2-0
100 mm	3	10	1-210-04-3-0
150 mm	1	10	1-210-06-1-0
150 mm	2	10	1-210-06-2-0
150 mm	3	10	1-210-06-3-0
200 mm	1	10	1-210-08-1-0
200 mm	2	10	1-210-08-2-0
200 mm	3	10	1-210-08-3-0
250 mm	1	10	1-210-10-1-0
250 mm	2	10	1-210-10-2-0
250 mm	3	10	1-210-10-3-0
300 mm	1	5	1-210-12-1-0
300 mm	2	5	1-210-12-2-0
300 mm	3	5	1-210-12-3-0
350 mm	1	5	1-210-14-1-0

Type of cut: 1 = Bastard, 2 = Second, 3 = Smooth

Engineering Round Files Bastard/Second/
Smooth Cut Unhandled



1-230...-0

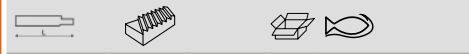

100 mm	1	10	1-230-04-1-0
100 mm	2	10	1-230-04-2-0
100 mm	3	10	1-230-04-3-0
150 mm	1	10	1-230-06-1-0
150 mm	2	10	1-230-06-2-0
150 mm	3	10	1-230-06-3-0
200 mm	1	10	1-230-08-1-0
200 mm	2	10	1-230-08-2-0
200 mm	3	10	1-230-08-3-0
250 mm	1	10	1-230-10-1-0
250 mm	2	10	1-230-10-2-0
250 mm	3	10	1-230-10-3-0
300 mm	1	5	1-230-12-1-0
300 mm	2	5	1-230-12-2-0
300 mm	3	5	1-230-12-3-0

Type of cut: 1 = Bastard, 2 = Second, 3 = Smooth

Engineering Three Square Files Bastard/
Second/Smooth Cut Unhandled



1-170...-0

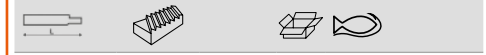

100 mm	1	10	1-170-04-1-0
100 mm	2	10	1-170-04-2-0
100 mm	3	10	1-170-04-3-0
150 mm	1	10	1-170-06-1-0
150 mm	2	10	1-170-06-2-0
150 mm	3	10	1-170-06-3-0
200 mm	1	10	1-170-08-1-0
200 mm	2	10	1-170-08-2-0
200 mm	3	10	1-170-08-3-0
250 mm	1	10	1-170-10-1-0
250 mm	2	10	1-170-10-2-0
250 mm	3	10	1-170-10-3-0
300 mm	1	5	1-170-12-1-0
300 mm	2	5	1-170-12-2-0

Type of cut: 1 = Bastard, 2 = Second, 3 = Smooth

ERGO™ Engineering Half-Round Files
Bastard/Second/Smooth Cut



1-210...-2



100 mm	1	5	1-210-04-1-2
100 mm	2	5	1-210-04-2-2
150 mm	1	5	1-210-06-1-2
150 mm	2	5	1-210-06-2-2
150 mm	3	5	1-210-06-3-2
200 mm	1	5	1-210-08-1-2
200 mm	2	5	1-210-08-2-2
200 mm	3	5	1-210-08-3-2
250 mm	1	5	1-210-10-1-2
250 mm	2	5	1-210-10-2-2
250 mm	3	5	1-210-10-3-2
300 mm	1	5	1-210-12-1-2
300 mm	2	5	1-210-12-2-2
300 mm	3	5	1-210-12-3-2

Type of cut: 1 = Bastard, 2 = Second, 3 = Smooth

ERGO™ Engineering Round Files
Bastard/Second/Smooth Cut



1-230...-2



100 mm	1	5	1-230-04-1-2
100 mm	2	5	1-230-04-2-2
150 mm	1	5	1-230-06-1-2
150 mm	2	5	1-230-06-2-2
150 mm	3	5	1-230-06-3-2
200 mm	1	5	1-230-08-1-2
200 mm	2	5	1-230-08-2-2
200 mm	3	5	1-230-08-3-2
250 mm	1	5	1-230-10-1-2
250 mm	2	5	1-230-10-2-2
250 mm	3	5	1-230-10-3-2
300 mm	1	5	1-230-12-1-2
300 mm	2	5	1-230-12-2-2
300 mm	3	5	1-230-12-3-2

Type of cut: 1 = Bastard, 2 = Second, 3 = Smooth

ERGO™ Engineering Three Square Files
Bastard/Second/Smooth Cut



1-170...-2



100 mm	2	5	1-170-04-2-2
150 mm	1	5	1-170-06-1-2
150 mm	2	5	1-170-06-2-2
150 mm	3	5	1-170-06-3-2
200 mm	1	5	1-170-08-1-2
200 mm	2	5	1-170-08-2-2
200 mm	3	5	1-170-08-3-2
250 mm	1	5	1-170-10-1-2
250 mm	2	5	1-170-10-2-2
250 mm	3	5	1-170-10-3-2

Type of cut: 1 = Bastard, 2 = Second, 3 = Smooth

Engineering Square Files Bastard/Second/
Smooth Cut Unhandled



1-160...-0

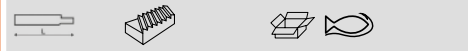

100 mm	1	10	1-160-04-1-0
100 mm	2	10	1-160-04-2-0
100 mm	3	10	1-160-04-3-0
150 mm	1	10	1-160-06-1-0
150 mm	2	10	1-160-06-2-0
150 mm	3	10	1-160-06-3-0
200 mm	1	10	1-160-08-1-0
200 mm	2	10	1-160-08-2-0
200 mm	3	10	1-160-08-3-0
250 mm	1	10	1-160-10-1-0
250 mm	2	10	1-160-10-2-0
250 mm	3	10	1-160-10-3-0
300 mm	1	5	1-160-12-1-0
300 mm	2	5	1-160-12-2-0
300 mm	3	5	1-160-12-3-0

Type of cut: 1 = Bastard, 2 = Second, 3 = Smooth

ERGO™ Engineering Square Files
Bastard/Second/Smooth Cut



1-160...-2

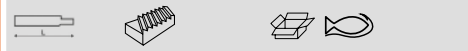

100 mm	1	5	1-160-04-1-2
100 mm	2	5	1-160-04-2-2
150 mm	1	5	1-160-06-1-2
150 mm	2	5	1-160-06-2-2
150 mm	3	5	1-160-06-3-2
200 mm	1	5	1-160-08-1-2
200 mm	2	5	1-160-08-2-2
200 mm	3	5	1-160-08-3-2
250 mm	1	5	1-160-10-1-2
250 mm	2	5	1-160-10-2-2
250 mm	3	5	1-160-10-3-2
300 mm	1	5	1-160-12-1-2
300 mm	2	5	1-160-12-2-2
300 mm	3	5	1-160-12-3-2

Type of cut: 1 = Bastard, 2 = Second, 3 = Smooth

ERGO™ Engineering File Set Smooth
Cut - 6 Pcs



1-476

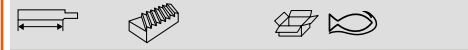

100 mm	3	1	1-476-04-3-2
--------	---	---	--------------

1-160-04-3-2, 1-111-04-3-2, 1-230-04-3-2, 1-170-04-3-2, 1-210-04-3-2, 1-100-04-3-2

ERGO™ Engineering File Set Second Cut
150 mm - 3 Pcs



1-473

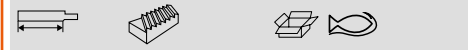

150 mm	2	5	1-473-06-2-2
--------	---	---	--------------

1-230-06-2-2

1-210-06-2-2

1-100-06-2-2

ERGO™ Engineering File Set Second Cut
200 mm - 3 Pcs



1-473-08-2-2

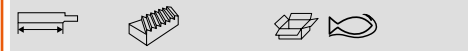

200 mm	2	5	1-473-08-2-2
--------	---	---	--------------

1-230-08-2-2

1-210-08-2-2

1-100-08-2-2

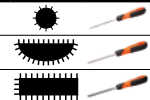

ERGO™ Engineering File Set Second Cut
250 mm - 3 Pcs



1-473-10-2-2_1

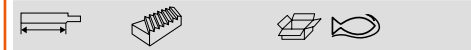

250 mm	2	5	1-473-10-2-2
--------	---	---	--------------

1-230-10-2-2

1-210-10-2-2

1-100-10-2-2

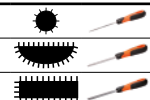

ERGO™ Engineering File Set with Half-
Round Rasp Second Cut 200 mm - 5 Pcs



1-477

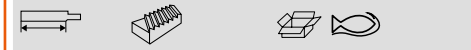

200 mm	2	5	1-477-08-2-2
--------	---	---	--------------

1-100-08-2-2

1-210-08-2-2

6-343-08-2-2

1-230-08-2-2

1-170-08-2-2

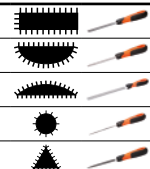

ERGO™ Engineering File Set with Half-Round Rasp Second Cut 250 mm - 5 Pcs



ergo



1-477-10-2-2

250 mm	2	5	1-477-10-2-2

1-100-10-2-2				
1-210-10-2-2				
6-343-10-2-2				
1-230-10-2-2				
1-170-10-2-2				

ERGO™ Engineering File Set 4 Bastard/1 Second Cut 200 mm - 5 Pcs



ergo



1-478

200 mm	1&2	5	1-478-08-1-2

1-210-08-1-2				
1-230-08-1-2				
1-100-08-1-2, 1-100-08-2-2				
1-160-08-1-2				

ERGO™ Engineering File Set 4 Bastard/1 Second Cut 250 mm - 5 Pcs



ergo



1-478-10-1-2_1

250 mm	1&2	5	1-478-10-1-2

1-210-10-1-2				
1-230-10-1-2				
1-100-10-1-2, 1-100-10-2-2				
1-160-10-1-2				

ERGO™ Engineering File Set with Cabinet Rasp Bastard Cut 200 mm - 5 Pcs



ergo



1-479

200 mm	1	5	1-479-08-1-2

4-138-08-1-2				
1-210-08-1-2				
6-343-08-2-2				
1-230-08-1-2				
1-100-08-1-2				

ERGO™ Engineering File Set with Cabinet Rasp Second Cut 200 mm - 5 Pcs



ergo



1-479-08-2-2

200 mm	2	5	1-479-08-2-2

4-138-08-1-2				
1-210-08-2-2				
6-343-08-2-2				
1-230-08-2-2				
1-100-08-2-2				

SHARPENING FILES

ERGO™ Flat Chainsaw Files



ergo



166-2

150 mm	3	5	166-6-16-2.5-2

Flat Chainsaw Files Unhandled



166/167-12

150 mm	3	12	166-6-16-2.5-12
200 mm	1	12	167-8-21-3.2-12

Round Chainsaw Files - 12 x 1 Pck



168 - 1P

150 mm	3.2 mm	12	168-6-3.2-1P
150 mm	3.5 mm	12	168-6-3.5-1P
200 mm	4.0 mm	12	168-8-4.0-1P
200 mm	4.5 mm	12	168-8-4.5-1P
200 mm	4.8 mm	12	168-8-4.8-1P
200 mm	5.2 mm	12	168-8-5.2-1P
200 mm	5.5 mm	12	168-8-5.5-1P
200 mm	6.3 mm	12	168-8-6.3-1P

Round Chainsaw Files - 12 x 3 Pck



168 - 3P

Length	Thickness	Quantity	Part No.
150 mm	3.2 mm	12	168-6-3.2-3P
150 mm	3.5 mm	12	168-6-3.5-3P
200 mm	4.0 mm	12	168-8-4.0-3P
200 mm	4.5 mm	12	168-8-4.5-3P
200 mm	4.8 mm	12	168-8-4.8-3P
200 mm	5.2 mm	12	168-8-5.2-3P
200 mm	5.5 mm	12	168-8-5.5-3P
200 mm	6.3 mm	12	168-8-6.3-3P

ERGO™ Chainsaw File Set with Two-Component Handle



168-C

Length	Thickness	Quantity	Part No.
200 mm	4.0 mm	10	168-COMBI-4.0
200 mm	4.5 mm	10	168-COMBI-4.5
200 mm	4.8 mm	10	168-COMBI-4.8
200 mm	5.5 mm	10	168-COMBI-5.5

Mill Saw Files with 2 Round Edges Bastard Cut Unhandled



4-140...-0

Length	Quantity	Quantity	Part No.
150 mm	1	10	4-140-06-1-0
200 mm	1	10	4-140-08-1-0
250 mm	1	10	4-140-10-1-0

Round Chainsaw Files - 6 Pck



168-8

Length	Thickness	Quantity	Part No.
200 mm	4.0 mm	6	168-8-4.0-6
200 mm	4.5 mm	6	168-8-4.5-6
200 mm	4.8 mm	6	168-8-4.8-6
200 mm	5.2 mm	6	168-8-5.2-6
200 mm	5.5 mm	6	168-8-5.5-6

Mill Saw Files with 1 Round Edge Bastard Cut Unhandled



4-138...-0

Length	Quantity	Quantity	Part No.
150 mm	1	10	4-138-06-1-0
200 mm	1	10	4-138-08-1-0
250 mm	1	10	4-138-10-1-0
300 mm	1	5	4-138-12-1-0

ERGO™ Mill Saw Files with Dual-Component Handle and 2 Round Edges Bastard Cut



4-140...-2

Length	Quantity	Quantity	Part No.
200 mm	1	5	4-140-08-1-2
250 mm	1	5	4-140-10-1-2

ERGO™ Chainsaw File Set with Two-Component Handle and Filing Guide



168-C-G

Length	Thickness	Quantity	Part No.
200 mm	4.0 mm	10	168-COMBI-4.0-6922
200 mm	4.8 mm	10	168-COMBI-4.8-6920
200 mm	5.5 mm	10	168-COMBI-5.5-6924

ERGO™ Mill Saw Files with Dual-Component Handle and 1 Round Edge Bastard Cut



4-138...-2

Length	Quantity	Quantity	Part No.
150 mm	1	5	4-138-06-1-2
200 mm	1	5	4-138-08-1-2
250 mm	1	5	4-138-10-1-2
300 mm	1	5	4-138-12-1-2

Mill Saw Files with 2 Flat Edges Bastard Cut Unhandled



4-142

Length	Quantity	Quantity	Part No.
150 mm	1	10	4-142-06-1-0
200 mm	1	10	4-142-08-1-0
250 mm	1	10	4-142-10-1-0



Mill Saw Files with 1 Round Edge Extra thin Second Cut Unhandled



4-144...-0

200 mm	2	10	4-144-08-2-0

2-in-1 ERGO™ Homeowner's Files with Two-Component Handle for Metal



4-153

200 mm	1 & 1	5	4-153-08-1-2

Taper Saw Files Second Cut Unhandled



4-183...-0

100 mm	2	10	4-183-04-2-0
125 mm	2	10	4-183-05-2-0
150 mm	2	10	4-183-06-2-0
175 mm	2	10	4-183-07-2-0
200 mm	2	10	4-183-08-2-0
250 mm	2	10	4-183-10-2-0

ERGO™ Mill Saw Files with Dual-Component Handle and 1 Round Edge Second Cut



4-144...-2

200 mm	2	5	4-144-08-2-2

4-in-2 ERGO™ Homeowner's File Set with Two-Component Handle for Wood and Metal



4-154

200 mm	1 & 2	10	4-154-08-2-2

ERGO™ Taper Saw Files with Dual-Component Handle Second Cut



4-183...-2

100 mm	2	5	4-183-04-2-2
125 mm	2	5	4-183-05-2-2
150 mm	2	5	4-183-06-2-2
175 mm	2	5	4-183-07-2-2
200 mm	2	5	4-183-08-2-2

2-in-1 ERGO™ Homeowner's Files with Two-Component Handle for Wood & Metal



4-152

200 mm	2 & 2	5	4-152-08-2-2

2-in-1 Farmer's own double Duty Files Bastard Cut



4-155

200 mm	1	10	4-155-08-2-0
250 mm	1	5	4-155-10-2-0

Slim Taper Saw Files Second Cut Unhandled



4-186...-0

100 mm	2	10	4-186-04-2-0
125 mm	2	10	4-186-05-2-0
150 mm	2	10	4-186-06-2-0
175 mm	2	10	4-186-07-2-0
200 mm	2	10	4-186-08-2-0

ERGO™ Slim Taper Files with Dual-Component Handle Second Cut



4-186...-2



100 mm	2	5	4-186-04-2-2
125 mm	2	5	4-186-05-2-2
150 mm	2	5	4-186-06-2-2

Double Extra Slim Taper Saw Files Second Cut Unhandled



4-188...-0



125 mm	2	10	4-188-05-2-0
150 mm	2	10	4-188-06-2-0

ERGO™ Double-Ended Saw Files with Dual-Component Handle Second Cut



4-190...-2



150 mm	2	5	4-190-06-2-2
175 mm	2	5	4-190-07-2-2
200 mm	2	5	4-190-08-2-2

Extra Slim Taper Saw Files Second Cut Unhandled



4-187...-0



100 mm	2	10	4-187-04-2-0
112 mm	2	10	4-187-45-2-0
125 mm	2	10	4-187-05-2-0
150 mm	2	10	4-187-06-2-0
175 mm	2	10	4-187-07-2-0

ERGO™ Double Extra Slim Taper Files with Dual-Component Handle Second Cut



4-188...-2



125 mm	2	5	4-188-05-2-2
--------	---	---	--------------

Tapered Bandsaw Files Second Cut Unhandled



4-192...-0



150 mm	2	10	4-192-06-2-0
175 mm	2	10	4-192-07-2-0
200 mm	2	10	4-192-08-2-0

ERGO™ Extra Slim Taper Files with Dual-Component Handle Second Cut



4-187...-2



125 mm	2	5	4-187-05-2-2
150 mm	2	5	4-187-06-2-2

Double-Ended Saw Files with Wooden Handle Second Cut



4-190...-0



175 mm	2	10	4-190-07-2-0
200 mm	2	10	4-190-08-2-0

ERGO™ Tapered Bandsaw Files with Dual-Component Handle Second Cut



4-192...-2



150 mm	2	5	4-192-06-2-2
200 mm	2	5	4-192-08-2-2



Machine Bandsaw Files Second Cut



4-202 - 4-204

Length	Files per Pack	Files per Box	Product Code
216 mm	2	10	4-202-85-2-0
216 mm	2	10	4-204-85-2-0

Wasa™ Double Edge Saw Files Smooth Cut Unhandled



4-272...-0

Length	Files per Pack	Files per Box	Product Code
150 mm	3	10	4-272-06-3-0

ERGO™ Wasa™ Double Edge Saw Files with Dual-Component Handle Smooth Cut



4-272...-2

Length	Files per Pack	Files per Box	Product Code
125 mm	3	5	4-272-05-3-2
150 mm	3	5	4-272-06-3-2

RASPS

Flat Hand Rasps Medium Cut Unhandled



6-344...-0

Length	Rasps per Pack	Rasps per Box	Product Code
200 mm	2	10	6-344-08-2-0
250 mm	2	10	6-344-10-2-0

ERGO™ Flat Hand Rasps Medium Cut



6-344...-2

Length	Rasps per Pack	Rasps per Box	Product Code
200 mm	2	5	6-344-08-2-2
250 mm	2	5	6-344-10-2-2

Half-Round Rasps Coarse/Medium Cut Unhandled



6-342...-0

Length	Rasps per Pack	Rasps per Box	Product Code
150 mm	2	10	6-342-06-2-0
200 mm	1	10	6-342-08-1-0
200 mm	2	10	6-342-08-2-0
250 mm	1	10	6-342-10-1-0
250 mm	2	10	6-342-10-2-0

ERGO™ Half-Round Rasps Coarse/Medium Cut



6-342...-2

Length	Rasps per Pack	Rasps per Box	Product Code
150 mm	2	5	6-342-06-2-2
200 mm	1	5	6-342-08-1-2
200 mm	2	5	6-342-08-2-2
250 mm	1	5	6-342-10-1-2
250 mm	2	5	6-342-10-2-2

Half-Round Cabinet Rasps Medium/Fine Cut Unhandled



6-343...-0

Length	Rasps per Pack	Rasps per Box	Product Code
200 mm	2	10	6-343-08-2-0
200 mm	3	10	6-343-08-3-0
250 mm	2	10	6-343-10-2-0
250 mm	3	10	6-343-10-3-0

ERGO™ Half-Round Cabinet Rasps Medium Cut



6-343...-2

Length	Rasps per Pack	Rasps per Box	Product Code
200 mm	2	5	6-343-08-2-2
250 mm	2	5	6-343-10-2-2

Round Rasps Medium Cut Unhandled



6-345...-0

200 mm	2	10	6-345-08-2-0
250 mm	2	10	6-345-10-2-0

ERGO™ Round Rasps Coarse/Medium Cut



6-345...-2

200 mm	1	5	6-345-08-1-2
200 mm	2	5	6-345-08-2-2
250 mm	1	5	6-345-10-1-2

ERGO™ Rasp File Set Second Cut - 3 Pcs



6-470

200 mm	2	5	6-470-08-2-2

6-345-08-2-2

6-342-08-2-2

4-152-08-2-2

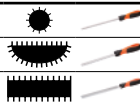

MILLED TOOTH FILES

Pansar® Milled Tooth Flat Blades Bastard/Second Cut Unhandled



3-330

300 mm	1	5	3-330-12-1-0
300 mm	2	5	3-330-12-2-0
350 mm	1	5	3-330-14-1-0
350 mm	2	5	3-330-14-2-0

Pansar® Milled Tooth Half-Round Blades Bastard Cut Unhandled



3-331

350 mm	1	5	3-331-14-1-0

ERGO™ Milled Tooth Filemasters with Two-component handle



FM10

300 mm	4 & 5	5	FM12
250 mm	4 & 5	5	FM10

ERGO™ Milled Tooth Half-Round Filemasters with Two-component handle



HRFM10

250 mm	5	5	HRFM10

NEEDLE FILES

Needle Flat Files Bastard/Second/Smooth/Dead Smooth Cut Unhandled



2-300

140 mm	0	10	2-300-14-0-0
140 mm	2	10	2-300-14-2-0
140 mm	4	10	2-300-14-4-0
160 mm	0	10	2-300-16-0-0
160 mm	1	10	2-300-16-1-0
160 mm	2	10	2-300-16-2-0
160 mm	4	10	2-300-16-4-0
180 mm	0	10	2-300-18-0-0
180 mm	2	10	2-300-18-2-0

Needle Flat Files with Tapered Edge Bastard/Second/Smooth Cut Unhandled



2-301

140 mm	0	10	2-301-14-0-0
140 mm	2	10	2-301-14-2-0
160 mm	0	10	2-301-16-0-0
160 mm	1	10	2-301-16-1-0
160 mm	2	10	2-301-16-2-0



Needle Half-Round Files Bastard/Second/
Smooth/Dead Smooth Cut Unhandled



2-304

Length	Coarse	Second	Smooth	Dead
140 mm	0	10	2-304-14-0-0	
140 mm	2	10	2-304-14-2-0	
140 mm	4	10	2-304-14-4-0	
160 mm	0	10	2-304-16-0-0	
160 mm	1	10	2-304-16-1-0	
160 mm	2	10	2-304-16-2-0	
160 mm	4	10	2-304-16-4-0	
180 mm	0	10	2-304-18-0-0	
180 mm	2	10	2-304-18-2-0	

Needle Half-Round Files Bastard Cut
Unhandled



2-313

Length	Coarse	Second	Smooth	Dead
160 mm	0	10	2-313-16-0-0	

Needle Round Files Bastard/Second/
Smooth/Dead Smooth Cut Unhandled



2-307

Length	Coarse	Second	Smooth	Dead
140 mm	0	10	2-307-14-0-0	
140 mm	2	10	2-307-14-2-0	
140 mm	4	10	2-307-14-4-0	
160 mm	0	10	2-307-16-0-0	
160 mm	1	10	2-307-16-1-0	
160 mm	2	10	2-307-16-2-0	
160 mm	4	10	2-307-16-4-0	
180 mm	0	10	2-307-18-0-0	
180 mm	2	10	2-307-18-2-0	

Needle Oval Files Second/Smooth Cut
Unhandled



2-305

Length	Coarse	Second	Smooth	Dead
160 mm	1	10	2-305-16-1-0	
160 mm	2	10	2-305-16-2-0	

Needle Crossing Files Second/Smooth Cut
Unhandled



2-306

Length	Coarse	Second	Smooth	Dead
160 mm	1	10	2-306-16-1-0	
160 mm	2	10	2-306-16-2-0	

Needle Three Square Files Bastard/
Second/Smooth/Dead Smooth Cut
Unhandled



2-302

Length	Coarse	Second	Smooth	Dead
140 mm	0	10	2-302-14-0-0	
140 mm	2	10	2-302-14-2-0	
140 mm	4	10	2-302-14-4-0	
160 mm	0	10	2-302-16-0-0	
160 mm	1	10	2-302-16-1-0	
160 mm	2	10	2-302-16-2-0	
160 mm	4	10	2-302-16-4-0	
180 mm	0	10	2-302-18-0-0	
180 mm	2	10	2-302-18-2-0	

Needle Barrette Files Smooth/Dead
Smooth Cut Unhandled



2-309

Length	Coarse	Second	Smooth	Dead
160 mm	2	10	2-309-16-2-0	
160 mm	4	10	2-309-16-4-0	

Needle Knife Files Bastard/Second/
Smooth Cut Unhandled



2-308

Length	Coarse	Second	Smooth	Dead
140 mm	2	10	2-308-14-2-0	
160 mm	0	10	2-308-16-0-0	
160 mm	1	10	2-308-16-1-0	
160 mm	2	10	2-308-16-2-0	

Needle Square Files Bastard/Second/
Smooth/Dead Smooth Cut Unhandled



2-303

Length	Coarse	Second	Smooth	Dead
140 mm	2	10	2-303-14-2-0	
160 mm	0	10	2-303-16-0-0	
160 mm	1	10	2-303-16-1-0	
160 mm	2	10	2-303-16-2-0	
160 mm	4	10	2-303-16-4-0	
180 mm	0	10	2-303-18-0-0	
180 mm	2	10	2-303-18-2-0	

Needle File Set Bastard Cut Unhandled
140 mm - 6 Pcs

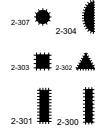

2-470

140 mm	0	10	2-470-14-0-0

9-488-02-10	
2-304-14-0-0	
2-300-14-0-0	
2-303-14-0-0	
2-302-14-0-0	
2-301-14-0-0	
2-307-14-0-0	

Needle File Set Smooth Cut Unhandled
140 mm - 6 Pcs



2-470-14-2-0

140 mm	2	10	2-470-14-2-0

9-488-02-10	
2-304-14-2-0	
2-300-14-2-0	
2-303-14-2-0	
2-302-14-2-0	
2-301-14-2-0	
2-307-14-2-0	

Needle File Set Dead Smooth Cut
Unhandled 140 mm - 6 Pcs



2-470-14-4-0

140 mm	4	10	2-470-14-4-0

9-488-02-10	
2-304-14-4-0	
2-300-14-4-0	
2-303-14-4-0, 2-301-14-4-0	
2-302-14-4-0	
2-307-14-4-0	

Needle File Set Second Cut Unhandled
160 mm - 6 Pcs



2-470-16-1-0

160 mm	1	10	2-470-16-1-0

9-488-02-10	
2-304-16-1-0	
2-300-16-1-0	
2-303-16-1-0	
2-302-16-1-0	
2-301-16-1-0	
2-307-16-1-0	

Needle File Set Smooth Cut Unhandled
160 mm - 6 Pcs



2-470-16-2-0

160 mm	2	10	2-470-16-2-0

9-488-02-10	
2-304-16-2-0	
2-300-16-2-0	
2-303-16-2-0	
2-302-16-2-0	
2-301-16-2-0	
2-307-16-2-0	

Needle File Set Second Cut Unhandled
160 mm - 9 Pcs



2-471

160 mm	1	5	2-471-16-1-0

9-488-02-10	
2-303-16-1-0	
2-304-16-1-0	
2-302-16-1-0	
2-300-16-1-0	
2-308-16-1-0	
2-301-16-1-0	
2-306-16-1-0	
2-305-16-1-0	
2-307-16-1-0	



Needle File Set Bastard Cut Unhandled
140 mm - 12 Pcs



2-472



140 mm 0 5 2-472-14-0-0

2-303-14-0-0, 2-313-14-0-0, 2-309-14-0-0, 2-306-14-0-0

2-300-14-0-0	
2-301-14-0-0	
2-304-14-0-0	
2-302-14-0-0	
2-307-14-0-0	
9-488-02-10	

Needle File Set Smooth Cut Unhandled
140 mm - 12 Pcs



2-472-14-2-0



140 mm 2 5 2-472-14-2-0

2-303-14-2-0	
2-300-14-2-0	
2-301-14-2-0	
2-304-14-2-0	
2-302-14-2-0	
2-313-14-2-0, 2-306-14-2-0	
2-307-14-2-0	
2-308-14-2-0	
9-488-02-10	

Needle File Set Bastard Cut Unhandled
160 mm - 12 Pcs



2-472-16-0-0



160 mm 0 5 2-472-16-0-0

2-303-16-0-0	
2-300-16-0-0	
2-301-16-0-0	
2-304-16-0-0	
2-302-16-0-0	
2-313-16-0-0	
2-307-16-0-0	
2-306-16-0-0	
2-308-16-0-0	
9-488-02-10	

Needle File Set Second Cut Unhandled
160 mm - 12 Pcs



2-472-16-1-0



160 mm 1 5 2-472-16-1-0

2-312-16-1-0, 2-313-16-1-0, 2-309-16-1-0

2-300-16-1-0	
2-301-16-1-0	
2-302-16-1-0	
2-303-16-1-0	
2-304-16-1-0	
2-306-16-1-0	
2-307-16-1-0	
2-308-16-1-0	
2-309-16-2-0	
2-311-16-2-0	
2-313-16-2-0	
9-488-02-10	

Needle File Set Smooth Cut Unhandled
160 mm - 12 Pcs



2-472-16-2-0

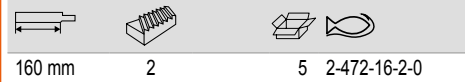

160 mm 2 5 2-472-16-2-0

2-312-16-2-0

2-303-16-2-0	
2-300-16-2-0	
2-301-16-2-0	
2-311-16-2-0	
2-304-16-2-0	
2-302-16-2-0	
2-313-16-2-0	
2-307-16-2-0	
2-309-16-2-0	
2-306-16-2-0	
2-308-16-2-0	
9-488-02-10	

DIAMOND FILES

Diamond Precision Needle Files
Unhandled



2-300-D - 2-304-D

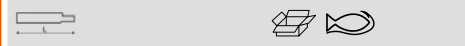

140 mm	10	2-300-14-D-1P
160 mm	10	2-300-16-D-1P
140 mm	1	2-301-14-D-1P
140 mm	10	2-302-14-D-1P
160 mm	10	2-302-16-D-1P
140 mm	10	2-303-14-D-1P
160 mm	1	2-303-16-D-1P
140 mm	10	2-304-14-D-1P
160 mm	10	2-304-16-D-1P

Diamond Precision Needle Files
Unhandled 140/160 mm



2-306-D - 2-308-D

140 mm	1	2-306-14-D-1P
140 mm	10	2-307-14-D-1P
160 mm	10	2-307-16-D-1P
140 mm	1	2-308-14-D-1P

Universal Handle for Needle Files



9-488-02

5 g	10	9-488-02-10

Steel Wire File Cards with Wooden Handle



9-469

110 mm	240 mm	1	9-469-00-0-0

Diamond Precision Files Integrated handle



5-600-D - 5-670-D

215 mm	10	5-600-21-D-1P
215 mm	5	5-610-21-D-1P
215 mm	1	5-630-21-D-1P
215 mm	1	5-670-21-D-1P

Plastic Handles for 8" Round Chainsaw Files



PH-6604

55 g	15	PH-6604-1P
50 g	25	PH-6604-25

ERGO™ Round Shaped Handles for Small files - 10 Pcs Loose



9-484...10

3.2	3.2 mm	10	9-484-3.2-10
5.2	5.2 mm	10	9-484-5.2-10

ACCESSORIES

Aluminum Holders for Pansar® 3-330 14" Flat Blade



9-462

350 mm	5	9-462-14-0-0

File Cleaners with Steel Wire Card



9-467

130 mm	260 mm	1	9-467-00-0-0

ERGO™ Round Shaped Handles for Small files - 1 Pck Carded



9-484...1P

3.2	3.2 mm	10	9-484-3.2-1P
5.2	5.2 mm	10	9-484-5.2-1P



ERGO™ Oval Shaped Handles for Flat & Half-Round Files - 10 Pcs Loose



ergo®



9-485...10

File Size	File Width	Quantity	Part Number
4	4 mm	10	9-485-04-10
5	5 mm	10	9-485-05-10
6	6 mm	10	9-485-06-10
9	9 mm	10	9-485-09-10
13	13 mm	10	9-485-13-10

ERGO™ Handles for Round Chainsaw Files - 1 Pck Carded



ergo®



9-486-C-1P

File Size	File Width	Quantity	Part Number
3.2	3.2 mm	10	9-486-C-1P

ERGO™ Oval Shaped Handles for Flat & Half-Round Files - 1 Pck Carded



ergo®



9-485...1P

File Size	File Width	Quantity	Part Number
4	4 mm	10	9-485-04-1P
5	5 mm	10	9-485-05-1P
6	6 mm	20	9-485-06-1P
9	9 mm	20	9-485-09-1P
13	13 mm	1	9-485-13-1P

ERGO™ Round Shaped Handles for Shaped Files - 10 Pcs Loose



ergo®



9-486...10

File Size	File Width	Quantity	Part Number
4	4 mm	10	9-486-04-10
5	5 mm	10	9-486-05-10
7	7 mm	10	9-486-07-10
8	8 mm	10	9-486-08-10

ERGO™ Handles for Round Chainsaw Files - 10 Pcs Loose



ergo®



9-486-C-10

File Size	File Width	Quantity	Part Number
3.2	3.2 mm	10	9-486-C-10

ERGO™ Round Shaped Handles for Shaped Files - 1 Pck Carded



ergo®



9-486...1P

File Size	File Width	Quantity	Part Number
4	4 mm	20	9-486-04-1P
5	5 mm	20	9-486-05-1P
7	7 mm	20	9-486-07-1P



Wrenches



ADJUSTABLE WRENCHES

ERGO™ Central Nut Adjustable Wrenches with Rubber Handle and Phosphate Finish



ergo



90

L	Hand	Box	Icon
158mm/6"	20 mm	5	9070
208mm/8"	27 mm	5	9071
257mm/10"	31 mm	5	9072
308mm/12"	34 mm	5	9073

ERGO™ rubber handle central nut phosphated adjustable wrench, with reversible jaw.



ergo



90P

L	Hand	Box	Icon
158mm/6"	21 mm	5	9070 P
208mm/8"	28 mm	5	9071 P
257mm/10"	33 mm	5	9072 P
308mm/12"	35 mm	5	9073 P

ERGO™ Central Nut Adjustable Wrenches with Rubber Handle and Chrome Finish



ergo



90C

L	Hand	Box	Icon
158mm/6"	20 mm	5	9070 C
208mm/8"	27 mm	5	9071 C
257mm/10"	31 mm	5	9072 C
308mm/12"	34 mm	3	9073 C

ERGO™ Rubber Handle Central Nut Adjustable Wrenches, with reversible jaw.



ergo



90PC

L	Hand	Box	Icon
158mm/6"	21 mm	5	9070 PC
208mm/8"	28 mm	5	9071 PC
257mm/10"	33 mm	5	9072 PC
308mm/12"	35 mm	3	9073 PC

ERGO™ Central Nut Wide Opening Jaw Adjustable Wrenches with Rubber Handle and Phosphate Finish



ergo



9029-9035

L	Hand	Box	Icon
170mm/6"	32 mm	5	9029
218mm/8"	38 mm	5	9031
270mm/10"	46 mm	5	9033
324mm/12"	55 mm	5	9035

ERGO™ Central Nut Wide Opening Jaw Adjustable Wrenches with Rubber Handle and Chrome Finish



ergo



9029C/9031C

L	Hand	Box	Icon
170mm/6"	32 mm	5	9029 C
218mm/8"	38 mm	5	9031 C

ERGO™ Central Nut Wide Opening Thin Jaw Adjustable Wrenches with Rubber Handle



ergo



9029-T/9031-T

L	Hand	Box	Icon
170mm/6"	32 mm	5	9029-T
218mm/8"	38 mm	5	9031-T

ERGO™ Central Nut Reversible Extra Wide Opening Jaw Adjustable Wrenches with Rubber Handle



ergo



9031P

L	Hand	Box	Icon
218mm/8"	39 mm	5	9031P

ERGO™ Central Nut Adjustable Wrench Set with Rubber Handle



ergo



ADJUST3-90

g	Box	Icon
900 g	1	ADJUST 3-90

9070, 9071, 9072



ERGO™ Adjustable Wrenches Twin Pack



ADJUST9031/29



550 g



3 ADJUST 9031/29

9029, 9031



Central Nut Adjustable Wrenches with Phosphate Finish



80



L	mm	mm	Qty	Part No.
110mm/4"	13 mm	5	8069	
155mm/6"	20 mm	5	8070	
205mm/8"	27 mm	5	8071	
255mm/10"	31 mm	5	8072	
305mm/12"	34 mm	5	8073	
380mm/15"	44 mm	3	8074	
455mm/18"	53 mm	3	8075	
110mm/4"	13 mm	50	8069 IP	
155mm/6"	20 mm	40	8070 IP	
205mm/8"	27 mm	50	8071 IP	
255mm/10"	31 mm	30	8072 IP	
305mm/12"	34 mm	20	8073 IP	
380mm/15"	44 mm	20	8074 IP	
455mm/18"	53 mm	10	8075 IP	

Standard Central Nut Adjustable Wrenches with Chrome Finish



80C



L	mm	mm	Qty	Part No.
110mm/4"	13 mm	5	8069 C	
155mm/6"	20 mm	5	8070 C	
205mm/8"	27 mm	5	8071 C	
255mm/10"	31 mm	5	8072 C	
305mm/12"	34 mm	5	8073 C	
380mm/15"	44 mm	3	8074 C	
455mm/18"	53 mm	3	8075 C	

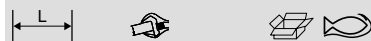

L	mm	mm	Qty	Part No.
110mm/4"	13 mm	5	8069 C IP	
155mm/6"	20 mm	5	8070 C IP	
205mm/8"	27 mm	5	8071 C IP	
255mm/10"	31 mm	5	8072 C IP	
305mm/12"	34 mm	5	8073 C IP	
380mm/15"	44 mm	3	8074 C IP	
455mm/18"	53 mm	3	8075 C IP	

Standard Central Nut Adjustable Wrenches with Phosphate Finish



86/87



L	mm	mm	Qty	Part No.
614mm/24"	63 mm	1	86	
770mm/30"	85 mm	3	87	

Standard Central Nut Adjustable Wrench Set



ADJUST3

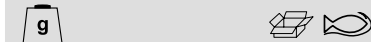

810 g 1 ADJUST 3

8070, 8071, 8072

Spare Jaw for Central Nut Adjustable Wrenches



RPS

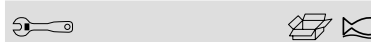

Part No.	Qty	Part No.
8069, 8069 C	1	8069-1
8070, 8070 C, 9070, 9070 C	1	8070-1
8071, 8071 C, 9071, 9071 C	1	8071-1



Part No.	Qty	Part No.
8072, 8072 C, 9072, 9072 C	1	8072-1
8073, 8073 C, 9073, 9073 C	1	8073-1
8074, 8074 C	1	8074-1
8075, 8075 C	1	8075-1
9029, 9029 C, 31	1	9029-1
9029-T	1	9029T-1
9031, 9031 C	1	9031-1
9031-T	1	9031T-1
9033, 33H	1	9033-1
9035	1	9035-1
86	1	86-1
87	1	87-1
9031 P	1	9031 P-1
9070 P, 9070 PC	1	9070 P-1
9071 P, 9071 PC	1	9071 P-1
9072 P, 9072 PC	1	9072 P-1
9073 P, 9073 PC	1	9073 P-1

Spare Knurl, Pin & Spring for Central Nut Adjustable Wrenches



RPS2



Part No.	g	Qty	Part No.
8069, 8069 C	3 g	1	8069-2
8070, 8070 C, 9070, 9070 C, 9070 P, 9070 PC	8 g	1	8070-2
8071, 8071 C, 9071, 9071 C, 9071 P, 9071 PC	10 g	1	8071-2
8072, 8072 C, 9072, 9072 C, 9072 P, 9072 PC	16 g	1	8072-2
8073, 8073 C, 9073, 9073 C, 9073 P, 9073 PC, 9033	25 g	1	8073-2
8074, 8074 C, 9035	47 g	1	8074-2
8075, 8075 C	54 g	1	8075-2
9029, 9029 C, 9029-T, 9031-T, 31, 9031, 9031 C, 9031P	9 g	1	9029-2
86	125 g	1	86-2
87	185 g	1	87-2



Podger Adjustable Wrenches with Phosphate Finish



84

405mm/16"	41 mm	1	84-PODGER

Wide Jaw Adjustable Wrenches with Serrated Pipe Jaws and Phosphate Finish



31

209mm/8"	32 mm	5	31
209mm/8"	32 mm	50	31 IP

Thin Jaw Adjustable Spanners with Serrated Pipe Jaws & Phosphate Finish



31-T

209mm/8"	32 mm	5	31-T
209mm/8"	32 mm	50	31-T IP

Wide Jaw Adjustable Wrenches with Hook and Phosphate Finish



33H

254mm/10"	46 mm	5	33H

Side Nut Heavy Duty Adjustable Wrenches with Rubber Handle and Phosphate Finish



95

257mm/10"	35 mm	5	9572

Side Nut Adjustable Wrenches with Chrome Finish



91C/97C

155mm/6"	21 mm	5	91C
205mm/8"	29 mm	5	92C
255mm/10"	34 mm	5	93C
305mm/12"	39 mm	5	94C
405mm/16"	48 mm	1	95C
500mm/20"	60 mm	1	96C
750mm/30"	77 mm	1	97C



COMBINATION WRENCHES

Metric Flat Combination Wrenches with Chrome Finish



111M



5.5 mm		10	111M-5.5
6 mm		10	111M-6
7 mm		10	111M-7
8 mm		10	111M-8
9 mm		10	111M-9
10 mm		10	111M-10
11 mm		10	111M-11
12 mm		10	111M-12
13 mm		10	111M-13
14 mm		10	111M-14
15 mm		10	111M-15
16 mm		10	111M-16
17 mm		10	111M-17
18 mm		10	111M-18
19 mm		10	111M-19
20 mm		10	111M-20
21 mm		10	111M-21
22 mm		5	111M-22
23 mm		5	111M-23
24 mm		5	111M-24
25 mm		5	111M-25
26 mm		5	111M-26
27 mm		5	111M-27
28 mm		5	111M-28
29 mm		5	111M-29
30 mm		5	111M-30
32 mm		5	111M-32
33 mm		5	111M-33
34 mm		5	111M-34
36 mm		1	111M-36
38 mm		1	111M-38
41 mm		1	111M-41
46 mm		1	111M-46
50 mm		1	111M-50
55 mm		1	111M-55
60 mm		1	111M-60
65 mm		1	111M-65
70 mm		1	111M-70
75 mm		1	111M-75
80 mm		1	111M-80
85 mm		1	111M-85
90 mm		1	111M-90
95 mm		1	111M-95
100 mm		1	111M-100
5.5 mm		1	SB111M-5,5
6 mm		1	SB111M-6
7 mm		1	SB111M-7
8 mm		1	SB111M-8
9 mm		1	SB111M-9
10 mm		1	SB111M-10
11 mm		1	SB111M-11
12 mm		1	SB111M-12
13 mm		1	SB111M-13
14 mm		1	SB111M-14
15 mm		1	SB111M-15

  	
16 mm	1 SB111M-16
17 mm	1 SB111M-17
18 mm	1 SB111M-18
19 mm	1 SB111M-19
20 mm	1 SB111M-20
21 mm	1 SB111M-21
22 mm	1 SB111M-22
23 mm	1 SB111M-23
24 mm	1 SB111M-24
25 mm	1 SB111M-25
26 mm	1 SB111M-26
27 mm	1 SB111M-27
28 mm	1 SB111M-28
29 mm	1 SB111M-29
30 mm	1 SB111M-30
32 mm	1 SB111M-32

Imperial Stubby Combination Wrenches with Chrome Finish





1Z

  	
3/16 in	20 1Z-3/16
7/32 in	20 1Z-7/32
9/32 in	20 1Z-9/32
5/16 in	10 1Z-5/16
11/32 in	10 1Z-11/32
3/8 in	10 1Z-3/8
7/16 in	10 1Z-7/16
1/2 in	10 1Z-1/2
9/16 in	10 1Z-9/16
5/8 in	10 1Z-5/8
11/16 in	10 1Z-11/16
3/4 in	10 1Z-3/4
13/16 in	10 1Z-13/16
7/8 in	5 1Z-7/8
15/16 in	5 1Z-15/16
1 in	10 1Z-1

Imperial Flat Combination Wrenches with Chrome Finish





111Z

  	
1/4 in	5 111Z-1/4
5/16 in	5 111Z-5/16
3/8 in	5 111Z-3/8
7/16 in	5 111Z-7/16
1/2 in	5 111Z-1/2
9/16 in	5 111Z-9/16
5/8 in	5 111Z-5/8
11/16 in	5 111Z-11/16
3/4 in	5 111Z-3/4
13/16 in	5 111Z-13/16
7/8 in	5 111Z-7/8
15/16 in	3 111Z-15/16
1 in	3 111Z-1
1 1/16 in	5 111Z-1.1/16
1 1/8 in	5 111Z-1.1/8
1 1/4 in	5 111Z-1.1/4
1 5/16 in	5 111Z-1.5/16
1 3/8 in	1 111Z-1.3/8
1 7/16 in	1 111Z-1.7/16
1 1/2 in	1 111Z-1.1/2
1 5/8 in	1 111Z-1.5/8
1 11/16 in	1 111Z-1.11/16
1 3/4 in	1 111Z-1.3/4
1 13/16 in	1 111Z-1.13/16
1 7/8 in	1 111Z-1.7/8
2 in	1 111Z-2
2 1/8 in	1 111Z-2.1/8
2 1/4 in	1 111Z-2.1/4
2 3/8 in	1 111Z-2.3/8
2 1/2 in	1 111Z-2.1/2
2 5/8 in	1 111Z-2.5/8
2 3/4 in	1 111Z-2.3/4
2 7/8 in	1 111Z-2.7/8
3 in	1 111Z-3

Metric Flat Combination Wrenches with Matte Finish





S20

  	
9	1 SBS20-9
12	1 SBS20-12
15	1 SBS20-15
16	1 SBS20-16
20	1 SBS20-20

Metric Flat Combination Wrench Set - 5 Pcs/Plastic Holder



111M/SH5

  	
5	1 111M/SH5

111M-8, 111M-10, 111M-13, 111M-17, 111M-19

Metric Flat Combination Wrench Set - 8 Pcs/Plastic Holder



111M/SH8

  	
8	1 111M/SH8

111M-8, 111M-10, 111M-12, 111M-13, 111M-14, 111M-17, 111M-19, 111M-22

Metric Flat Combination Wrench Set 9-18 mm - 12 Pcs/Plastic Holder



111M/SH12

  	
12	1 111M/SH12

111M-8, 111M-9, 111M-10, 111M-11, 111M-12, 111M-13, 111M-14, 111M-15, 111M-16, 111M-17, 111M-18, 111M-19



Metric Flat Combination Wrench Set
Cardboard Box



111M/



10

1 111M/S10

111M-8, 111M-9, 111M-10, 111M-11,
111M-12, 111M-13, 111M-14, 111M-17,
111M-19, 111M-22



Metric Flat Combination Wrench Set - 11
Pcs/Pouch



111M/11T



11

1 111M/11T

111M-8, 111M-9, 111M-10, 111M-11,
111M-12, 111M-13, 111M-14, 111M-15,
111M-17, 111M-19, 111M-22



Metric Flat Combination Wrench Set - 14
Pcs/Pouch



111M/14T



14

1 111M/14T

111M-6, 111M-8, 111M-9, 111M-10,
111M-13, 111M-14, 111M-15, 111M-17,
111M-19, 111M-22, 111M-24, 111M-27,
111M-30, 111M-32



Metric Flat Combination Wrench Set 6-22
mm - 17 Pcs/Pouch



111M/17T



17

1 111M/17T

111M-6, 111M-7, 111M-8, 111M-9,
111M-10, 111M-11, 111M-12, 111M-13,
111M-14, 111M-15, 111M-16, 111M-17,
111M-18, 111M-19, 111M-20, 111M-21,
111M-22



Metric Flat Combination Wrench Set 8-32
mm - 17 Pcs/Pouch



111M/17TL



17

1 111M/17TL

111M-8, 111M-9, 111M-10, 111M-11,
111M-12, 111M-13, 111M-14, 111M-15,
111M-16, 111M-18, 111M-19, 111M-22,
111M-24, 111M-26, 111M-27, 111M-30,
111M-32



Metric Flat Combination Wrench Set - 24
Pcs/Pouch



111M/24T



24

1 111M/24T

111M-6, 111M-7, 111M-8, 111M-9,
111M-10, 111M-11, 111M-12, 111M-13,
111M-14, 111M-15, 111M-16, 111M-17,
111M-18, 111M-19, 111M-20, 111M-21,
111M-22, 111M-24, 111M-26, 111M-27,
111M-28, 111M-30, 111M-32, 111M-36



Metric Flat Combination Wrench Set - 26
Pcs/Pouch



111M/26T



26

1 111M/26T

111M-6, 111M-7, 111M-8, 111M-9, 111M-10,
111M-11, 111M-12, 111M-13, 111M-14, 111M-15,
111M-16, 111M-17, 111M-18, 111M-19, 111M-20,
111M-21, 111M-22, 111M-23, 111M-24, 111M-25,
111M-26, 111M-27, 111M-28, 111M-29, 111M-30,
111M-32



Imperial Flat Combination Wrench Set - 8
Pcs/Black Plastic Pouch



111Z/

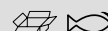

8

1 111Z/8T

111Z-3/8, 111Z-7/16, 111Z-1/2, 111Z-9/16, 111Z-5/8, 111Z-11/16, 111Z-3/4, 111Z-7/8



Imperial Flat Combination Wrench Set - 11 Pcs/Black Plastic Pouch



111Z/11T



11

1 111Z/11T

111Z-3/8, 111Z-7/16, 111Z-1/2, 111Z-9/16, 111Z-5/8, 111Z-11/16, 111Z-3/4, 111Z-13/16, 111Z-7/8, 111Z-15/16, 111Z-1



Metric Long Type Combination Wrenches with Chrome Finish



11M



8 mm	5	11M-8
9 mm	5	11M-9
10 mm	5	11M-10
11 mm	5	11M-11
12 mm	5	11M-12
13 mm	5	11M-13
14 mm	5	11M-14
15 mm	5	11M-15
16 mm	5	11M-16
17 mm	5	11M-17
18 mm	5	11M-18
19 mm	5	11M-19
21 mm	5	11M-21
22 mm	5	11M-22
24 mm	5	11M-24
27 mm	1	11M-27
30 mm	1	11M-30
32 mm	1	11M-32
36 mm	1	11M-36
38 mm	1	11M-38

Imperial Long Type Combination Wrenches with Chrome Finish



11Z



3/8 in	5	11Z-3/8
7/16 in	5	11Z-7/16
1/2 in	5	11Z-1/2
9/16 in	5	11Z-9/16
5/8 in	5	11Z-5/8
11/16 in	5	11Z-11/16
3/4 in	5	11Z-3/4
13/16 in	5	11Z-13/16
1 in	5	11Z-1

Metric Lilliput Combination Wrenches with Chrome Finish



4020L-M



3.2 mm	5	4020L-M-3.2
3.5 mm	5	4020L-M-3.5
4 mm	5	4020L-M-4
4.5 mm	5	4020L-M-4.5
5 mm	5	4020L-M-5
5.5 mm	5	4020L-M-5.5

Metric Offset Combination Wrenches with Chrome Finish



1952M



6 mm	10	1952M-6
7 mm	10	1952M-7
8 mm	10	1952M-8
9 mm	10	1952M-9
10 mm	10	1952M-10
11 mm	10	1952M-11
12 mm	10	1952M-12
13 mm	10	1952M-13
14 mm	10	1952M-14
15 mm	10	1952M-15



16 mm	10	1952M-16
17 mm	10	1952M-17
18 mm	10	1952M-18
19 mm	10	1952M-19
20 mm	10	1952M-20
21 mm	10	1952M-21
22 mm	5	1952M-22
23 mm	5	1952M-23
24 mm	5	1952M-24
25 mm	5	1952M-25
26 mm	5	1952M-26
27 mm	5	1952M-27
28 mm	1	1952M-28
29 mm	1	1952M-29
30 mm	1	1952M-30
32 mm	1	1952M-32
34 mm	1	1952M-34
36 mm	1	1952M-36
41 mm	1	1952M-41
46 mm	1	1952M-46
50 mm	1	1952M-50
55 mm	1	1952M-55
60 mm	1	1952M-60
65 mm	1	1952M-65
70 mm	1	1952M-70
75 mm	1	1952M-75
80 mm	1	1952M-80
7 mm	1	SB1952M-7
8 mm	1	SB1952M-8
10 mm	1	SB1952M-10
12 mm	1	SB1952M-12
13 mm	1	SB1952M-13
14 mm	1	SB1952M-14
17 mm	1	SB1952M-17
19 mm	1	SB1952M-19
24 mm	1	SB1952M-24

Imperial Offset Combination Wrenches with Chrome Finish



1952Z



1/4 in	5	1952Z-1/4
5/16 in	5	1952Z-5/16
11/32 in	5	1952Z-11/32
3/8 in	5	1952Z-3/8
7/16 in	5	1952Z-7/16
1/2 in	5	1952Z-1/2
9/16 in	5	1952Z-9/16
5/8 in	5	1952Z-5/8
11/16 in	5	1952Z-11/16
3/4 in	5	1952Z-3/4
13/16 in	5	1952Z-13/16
7/8 in	5	1952Z-7/8
15/16 in	5	1952Z-15/16
1 in	1	1952Z-1
1 1/16 in	1	1952Z-1.1/16
1 1/8 in	1	1952Z-1.1/8
1 1/4 in	1	1952Z-1.1/4
1 5/16 in	1	1952Z-1.5/16
1 3/8 in	1	1952Z-1.3/8
1 7/16 in	1	1952Z-1.7/16
1 1/2 in	1	1952Z-1.1/2
1 5/8 in	1	1952Z-1.5/8



Metric Offset Combination Wrenches with 12-Point Dynamic-Drive™



PU

6 mm	5	PU-6
9 mm	5	PU-9
14 mm	5	PU-14
20 mm	3	PU-20
22 mm	3	PU-22
24 mm	3	PU-24

Metric Offset Combination Wrench Set - 10 Pcs/Box



1952M/

10	1	1952M/10

1952M-8, 1952M-9, 1952M-10, 1952M-11, 1952M-12, 1952M-13, 1952M-14, 1952M-16, 1952M-17, 1952M-19

Metric Offset Combination Wrench Set - 17 Pcs/Pouch



1952M/17T

17	1	1952M/17T

1952M-6, 1952M-7, 1952M-8, 1952M-9, 1952M-10, 1952M-11, 1952M-12, 1952M-13, 1952M-14, 1952M-15, 1952M-16, 1952M-17, 1952M-18, 1952M-19, 1952M-20, 1952M-21, 1952M-22

Metric Offset Combination Ratcheting Wrench Set - 8 Pcs



1952M/SH

6	1	1952M/SH6

1952M-8, 1952M-10, 1952M-12, 1952M-13, 1952M-14, 1952M-17

Metric Offset Combination Wrench Set - 7 Pcs/Pouch



1952M/T

7	1	1952M/7T

1952M-8, 1952M-10, 1952M-13, 1952M-14, 1952M-17, 1952M-19, 1952M-22

Metric Offset Combination Wrench Set - 26 Pcs/Pouch



1952M/26T

26	1	1952M/26T

1952M-6, 1952M-7, 1952M-8, 1952M-9, 1952M-10, 1952M-11, 1952M-12, 1952M-13, 1952M-14, 1952M-15, 1952M-16, 1952M-17, 1952M-18, 1952M-19, 1952M-20, 1952M-21, 1952M-22, 1952M-23, 1952M-24, 1952M-25, 1952M-26, 1952M-27, 1952M-28, 1952M-29, 1952M-30, 1952M-32

Metric Offset Combination Ratcheting Wrench Set - 12 Pcs



1952M/SH12

12	1	1952M/SH12

1952M-8, 1952M-9, 1952M-10, 1952M-11, 1952M-12, 1952M-13, 1952M-14, 1952M-15, 1952M-16, 1952M-17, 1952M-18, 1952M-19

Metric Offset Combination Wrench Set - 14 Pcs/Pouch



1952M/14T

14	1	1952M/14T

1952M-6, 1952M-8, 1952M-9, 1952M-10, 1952M-13, 1952M-14, 1952M-15, 1952M-17, 1952M-19, 1952M-22, 1952M-24, 1952M-27, 1952M-30, 1952M-32

Imperial Offset Combination Wrench Set



1952Z/T



11 1 1952Z/11T

1952Z-1/4, 1952Z-5/16, 1952Z-3/8,
1952Z-7/16, 1952Z-1/2, 1952Z-9/16,
1952Z-5/8, 1952Z-11/16, 1952Z-3/4,
1952Z-13/16, 1952Z-7/8



RATCHETING WRENCHES

Metric Combination Ratcheting Wrenches with Chrome Finish



1RM



6 mm	1	1RM-6
7 mm	1	1RM-7
8 mm	1	1RM-8
9 mm	1	1RM-9
10 mm	1	1RM-10
11 mm	1	1RM-11
12 mm	1	1RM-12
13 mm	1	1RM-13
14 mm	1	1RM-14
15 mm	1	1RM-15
16 mm	1	1RM-16
17 mm	1	1RM-17
18 mm	1	1RM-18
19 mm	1	1RM-19
21 mm	1	1RM-21
22 mm	1	1RM-22
24 mm	1	1RM-24
27 mm	1	1RM-27
30 mm	1	1RM-30
32 mm	1	1RM-32



Imperial Combination Ratcheting Wrenches with Chrome Finish



1RZ



1/4 in	1	1RZ-1/4
5/16 in	1	1RZ-5/16
11/32 in	1	1RZ-11/32
3/8 in	1	1RZ-3/8
7/16 in	1	1RZ-7/16
1/2 in	1	1RZ-1/2
9/16 in	1	1RZ-9/16
5/8 in	1	1RZ-5/8
11/16 in	1	1RZ-11/16
3/4 in	1	1RZ-3/4
7/8 in	1	1RZ-7/8
15/16 in	1	1RZ-15/16



Metric Stubby Combination Ratcheting Wrenches with Chrome Finish



10RM



8 mm	1	10RM-8
10 mm	1	10RM-10
13 mm	1	10RM-13
14 mm	1	10RM-14
17 mm	1	10RM-17
19 mm	1	10RM-19



Imperial Stubby Combination Ratcheting Wrenches with Chrome Finish



10RZ



5/16 in	1	10RZ-5/16
3/8 in	1	10RZ-3/8
7/16 in	1	10RZ-7/16



1/2 in	1	10RZ-1/2
9/16 in	1	10RZ-9/16
5/8 in	1	10RZ-5/8
11/16 in	1	10RZ-11/16
3/4 in	1	10RZ-3/4

Metric Swivel Head Combination Ratcheting Wrenches with Chrome Finish



41RM



8 mm	1	41RM-8
10 mm	1	41RM-10
11 mm	1	41RM-11
12 mm	1	41RM-12
13 mm	1	41RM-13
14 mm	1	41RM-14
17 mm	1	41RM-17
19 mm	1	41RM-19
21 mm	1	41RM-21



Imperial Swivel Head Combination Ratcheting Wrenches with Chrome Finish



41RZ



5/16 in	1	41RZ-5/16
3/8 in	1	41RZ-3/8
7/16 in	1	41RZ-7/16
1/2 in	1	41RZ-1/2
9/16 in	1	41RZ-9/16
5/8 in	1	41RZ-5/8
11/16 in	1	41RZ-11/16
3/4 in	1	41RZ-3/4
13/16 in	1	41RZ-13/16
7/8 in	1	41RZ-7/8



Metric Combination Ratcheting Wrench Set - 6 Pcs/Plastic Holder



1RM/



6

1 1RM/SH6

1RM-8, 1RM-10, 1RM-12, 1RM-13, 1RM-14, 1RM-17



Metric Combination Ratcheting Wrench Set - 5 Pcs/Plastic Box



1RM/S5



5

10 1RM/S5

1RM-8, 1RM-10, 1RM-13, 1RM-17, 1RM-19



Stubby Combination Ratcheting Wrench Set



10RM/



6

1 10RM/SH6

10RM-8, 10RM-10, 10RM-13, 10RM-14, 10RM-17, 10RM-19



Metric Combination Ratcheting Wrench Set - 8 Pcs/Plastic Holder



1RM/SH8



8

1 1RM/SH8

1RM-8, 1RM-10, 1RM-11, 1RM-12, 1RM-13, 1RM-14, 1RM-17, 1RM-19



Imperial Combination Ratcheting Wrench Set Plastic Holder



1RZ/



8

1 1RZ/SH8

1RZ-5/16, 1RZ-3/8, 1RZ-7/16, 1RZ-1/2, 1RZ-9/16, 1RZ-5/8, 1RZ-11/16, 1RZ-3/4



Metric Swivel Head Combination Ratcheting Wrench Set Plastic Holder



41RM/SH8



8

10 41RM/SH8

41RM-8, 41RM-10, 41RM-11, 41RM-12, 41RM-13, 41RM-14, 41RM-17, 41RM-19



Metric Combination Ratcheting Wrench Set - 12 Pcs/Plastic Holder



1RM/SH12



12

10 1RM/SH12

1RM-8, 1RM-9, 1RM-10, 1RM-11, 1RM-12, 1RM-13, 1RM-14, 1RM-15, 1RM-16, 1RM-17, 1RM-18, 1RM-19



Combination Ratcheting Wrench and Adaptors Set



1RMA/S8



160 x 283 x 75 mm

1 1RMA/S8

1RMA-13-3/8-SQ, 1RMA-10-1/4-SQ, 1RMA-19-1/2-SQ



1RMA-13-5/16-BIT, 1RMA-10-1/4-BIT



1RM-13, 1RM-10, 1RM-19



Ratcheting Adjustable Ring Wrench Set



42RM/S12

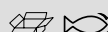

229 x 70 x 280 mm

1562 g

1 42RM/S12

Metric Ratcheting Ring Wrenches with Chrome Finish



1320RM

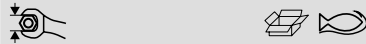

6-7 mm	1	1320RM-6-7
8-9 mm	1	1320RM-8-9
10-11 mm	1	1320RM-10-11
12-13 mm	1	1320RM-12-13
14-15 mm	1	1320RM-14-15
16-17 mm	1	1320RM-16-17
17-19 mm	1	1320RM-17-19
18-19 mm	1	1320RM-18-19
22-24 mm	1	1320RM-22-24

S Type Ratcheting Ring Wrenches with Chrome Finish



1320SRM

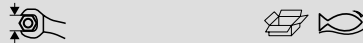

14-19 mm	1	1320SRM-14-19
----------	---	---------------

1320SRM-14-19

1RMA-19-17-HEX, 1RMA-19-16-HEX, 1RMA-19-15-HEX, 1RMA-19-13-HEX, 1RMA-19-9/16-HEX, 1RMA-19-5/8-HEX, 1RMA-19-11/16-HEX, 1RMA-19-1/2-HEX, 1RMA-19-E18-TX, 1RMA-19-E20-TX, 1RMA-19-E16-TX, 1RMA-19-E22-TX, 1RMA-19-1/2-SQ2, 1RMA-14-11-HEX, 1RMA-14-12-HEX, 1RMA-14-E11-TX, 1RMA-14-E12-TX, 1RMA-14-E10-TX, 1RMA-14-E14-TX, 1RMA-14-E8-TX, 1RMA-14-10-HEX, 1RMA-14-7/16-HEX, 1RMA-14-3/8-HEX, 1RMA-14-5/16-HEX, 1RMA-14-8-HEX, 1RMA-14-9-HEX

1RMA-19-1/4-SQ

SBS19-TH22

Imperial Ratcheting Ring Wrenches with Chrome Finish



1320RZ

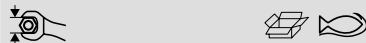

1/4-5/16" in	1	1320RZ-1/4-5/16
5/16-11/32 in	60	1320RZ-5/16-11/32
3/8-7/16" in	1	1320RZ-3/8-7/16
1/2-9/16" in	1	1320RZ-1/2-9/16
5/8-11/16" in	1	1320RZ-5/8-11/16
3/4-13/16" in	1	1320RZ-3/4-13/16
3/4-7/8" in	1	1320RZ-3/4-7/8
7/8-15/16" in	1	1320RZ-7/8-15/16

Metric Ratcheting Ring Wrench Set



1320RM/

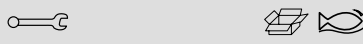

8	1	1320RM/SH8
---	---	------------

1320RM-6-7, 1320RM-8-9, 1320RM-10-11, 1320RM-12-13, 1320RM-14-15, 1320RM-16-17, 1320RM-18-19, 1320RM-22-24

Imperial Angled Head Ratcheting Ring Wrenches with Chrome Finish



1321RZ



3/8-7/16 in	1	1321RZ-3/8-7/16
1/2-9/16 in	1	1321RZ-1/2-9/16
5/8-11/16 in	1	1321RZ-5/8-11/16
3/4x7/8 in	1	1321RZ-3/4-7/8

S Type Ratcheting Ring Wrench and Adaptor Set



1320SRM/

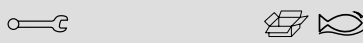

29	1	1320SRM/S29
----	---	-------------

4-in-1 Ratcheting Ring Wrenches with Chrome Finish



S4RM

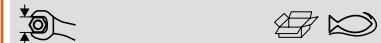

4x5 6x7 mm	1	S4RM-4-7
8x9 10x11 mm	1	S4RM-8-11
12x13 14x15 mm	1	S4RM-12-15
16x17 18x19 mm	1	S4RM-16-19
20x21 24x27 mm	1	S4RM-21-27
30x32 34x36 mm	1	S4RM-30-36

4-in-1 Ratcheting Ring Wrench Set - 3 Pcs/Pouch



S4RM/



3	20	S4RM/3T
---	----	---------

S4RM-8-11, S4RM-12-15, S4RM-16-19



4-in-1 Ratcheting Ring Wrench Set - 4 Pcs/Pouch



S4RM/4T

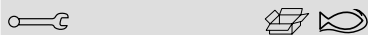

4	1	S4RM/4T
---	---	---------

S4RM-8-11, S4RM-12-15, S4RM-16-19, S4RM-21-27



4-in-1 Ratcheting Ring Wrench Set - 5 Pcs/Pouch



S4RM/5T



5	1	S4RM/5T
---	---	---------

S4RM-8-11, S4RM-12-15, S4RM-16-19, S4RM-21-27, S4RM-30-36



Drive Socket and Bit Adaptors for Ratcheting Wrenches



1RMA-SQ

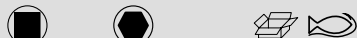

1/4 in	10 mm	1	1RMA-10-1/4-SQ
3/8 in	13 mm	1	1RMA-13-3/8-SQ
1/2 in	19 mm	1	1RMA-19-1/2-SQ
1/4 in	19 mm	1	1RMA-19-1/4-SQ

Ratcheting Wrenches Adaptors for 1/4" and 5/16" Bits



1RMA-BIT



1/4	10 mm	1	1RMA-10-1/4-BIT
5/16	13 mm	1	1RMA-13-5/16-BIT
10	13 mm	1	1RMA-13-10-BIT

Ratcheting Wrench Adaptor Set



1RMA/S4

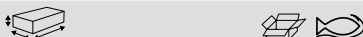

84 x 100 x 35 mm	1	1RMA/S4
------------------	---	---------

1RMA-10-1/4-SQ, 1RMA-19-1/2-SQ, 1RMA-13-3/8-SQ



1RMA-10-1/4-BIT



OPEN END WRENCHES

Metric Double Open End Wrenches with Chrome Finish



6M

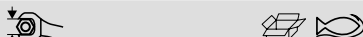

4x5 mm	10	6M-4-5
4.5x5.5 mm	10	6M-4.5-5.5
5x5.5 mm	10	6M-5-5.5

5.5x7 mm	10	6M-5.5-7	
6x7 mm	10	6M-6-7	
7x8 mm	10	6M-7-8	
8x9 mm	10	6M-8-9	
8x10 mm	10	6M-8-10	
10x11 mm	10	6M-10-11	
10x13 mm	10	6M-10-13	
12x13 mm	10	6M-12-13	
12x14 mm	10	6M-12-14	
13x14 mm	10	6M-13-14	
13x15 mm	10	6M-13-15	
13x16 mm	10	6M-13-16	
13x17 mm	10	6M-13-17	
14x15 mm	10	6M-14-15	
14x17 mm	10	6M-14-17	
16x17 mm	10	6M-16-17	
16x18 mm	10	6M-16-18	
17x19 mm	10	6M-17-19	
18x19 mm	10	6M-18-19	
19x22 mm	10	6M-19-22	
19x24 mm	10	6M-19-24	
20x22 mm	10	6M-20-22	
21x23 mm	10	6M-21-23	
21x24 mm	10	6M-21-24	
22x24 mm	10	6M-22-24	
24x26 mm	10	6M-24-26	
24x27 mm	10	6M-24-27	
24x30 mm	5	6M-24-30	
25x28 mm	5	6M-25-28	
27x29 mm	5	6M-27-29	
27x30 mm	5	6M-27-30	
27x32 mm	5	6M-27-32	
30x32 mm	5	6M-30-32	
30x36 mm	5	6M-30-36	
32x36 mm	5	6M-32-36	
34x36 mm	1	6M-34-36	
36x41 mm	1	6M-36-41	
38x42 mm	1	6M-38-42	
41x46 mm	1	6M-41-46	
46x50 mm	1	6M-46-50	
4x5 mm	1	SB6M-4-5	
6x7 mm	1	SB6M-6-7	
8x9 mm	1	SB6M-8-9	
10x11 mm	1	SB6M-10-11	
12x13 mm	1	SB6M-12-13	
14x15 mm	1	SB6M-14-15	
16x17 mm	1	SB6M-16-17	
17x19 mm	1	SB6M-17-19	
18x19 mm	1	SB6M-18-19	
20x22 mm	1	SB6M-20-22	
21x23 mm	1	SB6M-21-23	
22x24 mm	1	SB6M-22-24	
24x26 mm	1	SB6M-24-26	
24x27 mm	1	SB6M-24-27	
25x28 mm	1	SB6M-25-28	
27x29 mm	1	SB6M-27-29	
30x32 mm	1	SB6M-30-32	

Imperial Double Open End Wrenches with Chrome Finish



6Z

Size	Quantity	Part Number
1/4x5/16 in	5	6Z-1/4-5/16
5/16x11/32 in	5	6Z-5/16-11/32
3/8x7/16 in	5	6Z-3/8-7/16
7/16x1/2 in	5	6Z-7/16-1/2
1/2x9/16 in	5	6Z-1/2-9/16
9/16x5/8 in	5	6Z-9/16-5/8
19/32x11/16 in	5	6Z-19/32-11/16
5/8x3/4 in	5	6Z-5/8-3/4
11/16x3/4 in	5	6Z-11/16-3/4
3/4x7/8 in	5	6Z-3/4-7/8
25/32x13/16 in	5	6Z-25/32-13/16
13/16x7/8 in	5	6Z-13/16-7/8
7/8x15/16 in	5	6Z-7/8-15/16
15/16x1 in	5	6Z-15/16-1
1x1.1/8 in	1	6Z-1-1.1/8
1.1/16x1.1/4 in	1	6Z-1.1/16-1.1/4
1.1/4x1.3/8 in	1	6Z-1.1/4-1.3/8

Imperial Lilliput Double Open End Wrenches with Chrome Finish



1931Z

Size	Length	Quantity	Part Number
1/8 in	74 mm	5	1931Z-1/8
5/32 in	80 mm	5	1931Z-5/32
3/16 in	80 mm	5	1931Z-3/16
13/64 in	80 mm	5	1931Z-13/64
7/32 in	80 mm	5	1931Z-7/32
15/64x1/4 in	84 mm	5	1931Z-15/64-1/4
1/4 in	80 mm	5	1931Z-1/4
9/32 in	90 mm	5	1931Z-9/32
9/32x5/16 in	94 mm	5	1931Z-9/32-5/16
5/16 in	90 mm	5	1931Z-5/16
11/32 in	105 mm	5	1931Z-11/32
11/32x3/8 in	94 mm	5	1931Z-11/32-3/8
3/8 in	105 mm	5	1931Z-3/8
7/16 in	120 mm	5	1931Z-7/16
1/2 in	120 mm	5	1931Z-1/2
9/16 in	130 mm	5	1931Z-9/16
5/8 in	130 mm	5	1931Z-5/8

Metric Double Open End Wrench Set - 8 Pcs/Plastic Holder



6M/SH

Quantity	Part Number
8	6M/SH8

6M-6-7, 6M-8-9, 6M-10-11, 6M-12-13, 6M-14-15, 6M-16-17, 6M-18-19, 6M-20-22

Metric Double Open End Wrench Set - 12 Pcs/Plastic Holder



6M/SH12

Quantity	Part Number
12	6M/SH12

6M-6-7, 6M-8-9, 6M-10-11, 6M-12-13, 6M-14-15, 6M-16-17, 6M-18-19, 6M-20-22, 6M-21-23, 6M-24-26, 6M-25-28, 6M-30-32

Metric Lilliput Double Open End Wrenches with Chrome Finish



1931M

Size	Quantity	Part Number
4 mm	5	1931M-4
4.5 mm	5	1931M-4.5
5 mm	5	1931M-5
5.5 mm	5	1931M-5.5
6 mm	5	1931M-6
7 mm	5	1931M-7
8 mm	5	1931M-8
9 mm	5	1931M-9
10 mm	5	1931M-10
11 mm	5	1931M-11
12 mm	5	1931M-12
13 mm	5	1931M-13
14 mm	5	1931M-14
17 mm	5	1931M-17

Metric Double Open End Wrenches with Phosphate Finish



895M

Size	Length	Quantity	Part Number
6x7 mm	96 mm	10	895M-6-7
8x9 mm	109 mm	10	895M-8-9
8x10 mm	115 mm	10	895M-8-10
10x11 mm	124 mm	10	895M-10-11
10x13 mm	110 mm	10	895M-10-13
13x17 mm	155 mm	10	895M-13-17
17x19 mm	172 mm	10	895M-17-19
19x22 mm	195 mm	10	895M-19-22
19x24 mm	206 mm	5	895M-19-24
22x24 mm	220 mm	5	895M-22-24
24x27 mm	244 mm	5	895M-24-27
24x30 mm	265 mm	5	895M-24-30
27x32 mm	270 mm	5	895M-27-32
30x32 mm	275 mm	5	895M-30-32
30x36 mm	305 mm	1	895M-30-36
32x36 mm	307 mm	1	895M-32-36
36x41 mm	345 mm	1	895M-36-41
41x46 mm	381 mm	1	895M-41-46
46x50 mm	420 mm	1	895M-46-50
50x55 mm	460 mm	1	895M-50-55
55x60 mm	500 mm	1	895M-55-60
65x70 mm	580 mm	1	895M-65-70

Metric Double Open End Wrench Set - 8 Pcs/Box



6M/S

Quantity	Part Number
8	6M/S8

6M-6-7, 6M-8-9, 6M-10-11, 6M-12-13, 6M-14-15, 6M-16-17, 6M-18-19, 6M-20-22



Metric Double Open End Wrench Set - 6 Pcs/Plastic Clip



6M/



6

1 6M/6C

6M-6-7, 6M-8-9, 6M-10-11, 6M-12-13, 6M-14-15, 6M-16-17



Metric Double Open End Wrench Set - 12 Pcs/Plastic Clip



6M/12C



12

1 6M/12C

6M-6-7, 6M-8-9, 6M-10-11, 6M-12-13, 6M-14-15, 6M-16-17, 6M-18-19, 6M-20-22, 6M-21-23, 6M-24-27, 6M-25-28, 6M-30-32



Metric Double Open End Wrench Set - 8 Pcs/Plastic Clip



6M/8C



8

1 6M/8C

6M-6-7, 6M-8-9, 6M-10-11, 6M-12-13, 6M-14-15, 6M-16-17, 6M-18-19, 6M-20-22



Imperial Double Open End Wrench Set



6Z/



8

1 6Z/8C

6Z-1/4-5/16, 6Z-3/8-7/16, 6Z-5/16-11/32, 6Z-1/2-9/16, 6Z-19/32-11/16, 6Z-5/8-3/4, 6Z-13/16-7/8, 6Z-15/16-1



Metric Double Open End Wrench Set - 10 Pcs/Plastic Clip



6M/10C



10

1 6M/10C

6M-6-7, 6M-8-9, 6M-10-11, 6M-12-13, 6M-14-15, 6M-16-17, 6M-18-19, 6M-20-22, 6M-24-27, 6M-30-32



Metric Lilliput Double Open End Wrench Set



1931M/



10

1 1931M/10T

1931M-4, 1931M-4.5, 1931M-5, 1931M-5.5, 1931M-6, 1931M-7, 1931M-8, 1931M-9, 1931M-10, 1931M-11



Imperial Lilliput Double Open End Wrench Set



1931Z/



12

1 1931Z/12T

1931Z-5/32, 1931Z-9/32, 1931Z-5/16, 1931Z-11/32, 1931Z-3/8, 1931Z-3/16, 1931Z-7/32, 1931Z-1/4, 1931Z-7/16, 1931Z-1/2, 1931Z-5/8, 1931Z-9/16



Metric Electronic Double Open End Wrench Set



1933M/



6

1 1933M/6T

4x4, 4.5x4.5, 5x5, 5.5x5.5, 6x6, 7x7

Metric Double Open End Magneto Wrench Set on Ring



3280M/



8

1 3280M

4, 4.5, 5, 5.5, 6, 6.5, 7, 7.5 mm

1/4" Square Drive Crowfoot Open End Wrenches



677-

Icon 1	Icon 2	Icon 3	Icon 4
7 mm	1/4 in	1	677-7
8 mm	1/4 in	1	677-8
9 mm	1/4 in	1	677-9
10 mm	1/4 in	1	677-10
13 mm	1/4 in	1	677-13
3/8 in	1/4 in	1	677-3/8

3/8" Square Drive Crowfoot Open End Wrenches



747-

Icon 1	Icon 2	Icon 3	Icon 4
10 mm	3/8 in	1	747-10
11 mm	3/8 in	1	747-11
12 mm	3/8 in	1	747-12
13 mm	3/8 in	1	747-13
14 mm	3/8 in	1	747-14
15 mm	3/8 in	1	747-15
16 mm	3/8 in	1	747-16
17 mm	3/8 in	1	747-17
18 mm	3/8 in	1	747-18
19 mm	3/8 in	1	747-19
20 mm	3/8 in	1	747-20
21 mm	3/8 in	1	747-21
22 mm	3/8 in	1	747-22
23 mm	3/8 in	1	747-23
24 mm	3/8 in	1	747-24
25 mm	3/8 in	1	747-25
26 mm	3/8 in	1	747-26
27 mm	3/8 in	1	747-27
28 mm	3/8 in	1	747-28
30 mm	3/8 in	1	747-30
32 mm	3/8 in	1	747-32
34 mm	3/8 in	1	747-34
36 mm	3/8 in	1	747-36
40 mm	3/8 in	1	747-40
41 mm	3/8 in	1	747-41
42 mm	3/8 in	1	747-42
46 mm	3/8 in	1	747-46

Icon 1	Icon 2	Icon 3	Icon 4
50 mm	3/8 in	1	747-50
3/8 in	3/8 in	1	747-3/8
7/16 in	3/8 in	1	747-7/16
1/2 in	3/8 in	1	747-1/2
9/16 in	3/8 in	1	747-9/16
5/8 in	3/8 in	1	747-5/8
11/16 in	3/8 in	1	747-11/16
3/4 in	3/8 in	1	747-3/4
13/16 in	3/8 in	1	747-13/16
7/8 in	3/8 in	1	747-7/8
15/16 in	3/8 in	1	747-15/16
1 in	3/8 in	1	747-1
1.1/16 in	3/8 in	1	747-1.1/16
1.1/8 in	3/8 in	1	747-1.1/8
1.3/16 in	3/8 in	1	747-1.3/16
1.1/4 in	3/8 in	1	747-1.1/4
1.5/16 in	3/8 in	1	747-1.5/16
1.3/8 in	3/8 in	1	747-1.3/8
1.7/16 in	3/8 in	1	747-1.7/16
1.1/2 in	3/8 in	1	747-1.1/2
1.9/16 in	3/8 in	1	747-1.9/16
1.5/8 in	3/8 in	1	747-1.5/8
1.11/16 in	3/8 in	1	747-1.11/16
1.3/4 in	3/8 in	1	747-1.3/4
1.13/16 in	3/8 in	1	747-1.13/16
1.7/8 in	3/8 in	1	747-1.7/8
1.15/16 in	3/8 in	1	747-1.15/16
2 in	3/8 in	1	747-2
2.1/16 in	3/8 in	1	747-2.1/16
2.1/8 in	3/8 in	1	747-2.1/8
2.3/16 in	3/8 in	1	747-2.3/16
2.1/4 in	3/8 in	1	747-2.1/4
2.5/16 in	3/8 in	1	747-2.5/16
2.3/8 in	3/8 in	1	747-2.3/8
2.7/16 in	3/8 in	1	747-2.7/16
2.1/2 in	3/8 in	1	747-2.1/2
2.9/16 in	3/8 in	1	747-2.9/16
2.5/8 in	3/8 in	1	747-2.5/8
2.3/4 in	3/8 in	1	747-2.3/4
2.7/8 in	3/8 in	1	747-2.7/8

1/2" Square Drive Crowfoot Open End Wrenches



787-

Icon 1	Icon 2	Icon 3	Icon 4
1.1/16 in	1/2 in	1	787-1.1/16
1.1/8 in	1/2 in	1	787-1.1/8
1.3/16 in	1/2 in	1	787-1.3/16
1.1/4 in	1/2 in	1	787-1.1/4
1.5/16 in	1/2 in	1	787-1.5/16
1.3/8 in	1/2 in	1	787-1.3/8
1.7/16 in	1/2 in	1	787-1.7/16
1.1/2 in	1/2 in	1	787-1.1/2
1.5/8 in	1/2 in	1	787-1.5/8
1.11/16 in	1/2 in	1	787-1.11/16
1.3/4 in	1/2 in	1	787-1.3/4

Icon 1	Icon 2	Icon 3	Icon 4
1.13/16 in	1/2 in	1	787-1.13/16
1.7/8 in	1/2 in	1	787-1.7/8
2 in	1/2 in	1	787-2
2.1/8 in	1/2 in	1	787-2.1/8
2.3/16 in	1/2 in	1	787-2.3/16
2.1/4 in	1/2 in	1	787-2.1/4
2.3/8 in	1/2 in	1	787-2.3/8

Metric Single Open End Wrenches with Phosphate Finish



894M

Icon 1	Icon 2	Icon 3	Icon 4
7 mm	78 mm	10	894M-7
8 mm	94 mm	10	894M-8
9 mm	100 mm	10	894M-9
10 mm	106 mm	10	894M-10
11 mm	112 mm	10	894M-11
12 mm	125 mm	10	894M-12
13 mm	125 mm	10	894M-13
14 mm	140 mm	10	894M-14
15 mm	140 mm	10	894M-15
16 mm	140 mm	10	894M-16
17 mm	158 mm	10	894M-17
19 mm	171 mm	10	894M-19
21 mm	195 mm	5	894M-21
22 mm	195 mm	5	894M-22
24 mm	216 mm	5	894M-24
27 mm	240 mm	5	894M-27
30 mm	262 mm	5	894M-30
32 mm	274 mm	5	894M-32
34 mm	274 mm	1	894M-34
36 mm	303 mm	5	894M-36
38 mm	305 mm	1	894M-38
41 mm	343 mm	1	894M-41
46 mm	378 mm	1	894M-46
50 mm	413 mm	1	894M-50
55 mm	457 mm	1	894M-55
60 mm	492 mm	1	894M-60
65 mm	528 mm	1	894M-65
70 mm	573 mm	1	894M-70
75 mm	608 mm	1	894M-75
80 mm	644 mm	1	894M-80
85 mm	690 mm	1	894M-85
90 mm	690 mm	1	894M-90
95 mm	850 mm	1	894M-95
100 mm	1000 mm	1	894M-100
105 mm	1000 mm	1	894M-105
110 mm	1000 mm	1	894M-110
115 mm	1000 mm	1	894M-115
120 mm	1000 mm	1	894M-120
125 mm	1000 mm	1	894M-125
130 mm	1000 mm	1	894M-130
135 mm	1000 mm	1	894M-135



Metric Scaffolding Open End Wrench with Phosphate finish



Size	Length (mm)	Quantity	Part No.
30x32 mm	362 mm	5	2M-30-32
32x36 mm	402 mm	1	2M-32-36
36x41 mm	438 mm	1	2M-36-41
41x46 mm	485 mm	1	2M-41-46
46x50 mm	535 mm	1	2M-46-50

SC335M

Size	Length (mm)	Quantity	Part No.
17 mm	320 mm	1	SC335M-17
19 mm	350 mm	1	SC335M-19
22 mm	350 mm	1	SC335M-22
24 mm	370 mm	1	SC335M-24
27 mm	370 mm	1	SC335M-27
30 mm	400 mm	1	SC335M-30
32 mm	400 mm	1	SC335M-32
36 mm	430 mm	1	SC335M-36
41 mm	470 mm	1	SC335M-41
46 mm	500 mm	1	SC335M-46

RING END WRENCHES

Metric Deep Offset Double Ring End Wrenches with Chrome Finish



2M

Size	Length (mm)	Quantity	Part No.
6x7 mm	165 mm	5	2M-6-7
8x9 mm	180 mm	5	2M-8-9
8x10 mm	180 mm	5	2M-8-10
10x11 mm	190 mm	5	2M-10-11
10x13 mm	190 mm	5	2M-10-13
12x13 mm	210 mm	5	2M-12-13
13x17 mm	243 mm	5	2M-13-17
14x15 mm	226 mm	5	2M-14-15
16x17 mm	246 mm	5	2M-16-17
16x18 mm	246 mm	5	2M-16-18
17x19 mm	266 mm	5	2M-17-19
18x19 mm	266 mm	5	2M-18-19
19x22 mm	291 mm	5	2M-19-22
20x22 mm	291 mm	5	2M-20-22
21x23 mm	306 mm	5	2M-21-23
22x24 mm	306 mm	5	2M-22-24
24x26 mm	326 mm	5	2M-24-26
24x27 mm	326 mm	5	2M-24-27
25x28 mm	336 mm	5	2M-25-28
27x29 mm	351 mm	5	2M-27-29
27x30 mm	351 mm	5	2M-27-30
27x32 mm	353 mm	5	2M-27-32

Imperial Deep Offset Double Ring End Wrenches with Chrome Finish



ZZ

Size	Length (mm)	Quantity	Part No.
1/4x5/16 in	165 mm	1	ZZ-1/4-5/16
5/16x3/8 in	180 mm	1	ZZ-5/16-3/8
3/8x7/16 in	190 mm	1	ZZ-3/8-7/16
1/2x9/16 in	210 mm	1	ZZ-1/2-9/16
9/16x5/8 in	225.8 mm	1	ZZ-9/16-5/8
5/8x11/16 in	245.5 mm	1	ZZ-5/8-11/16
3/4x7/8 in	290.5 mm	1	ZZ-3/4-7/8
13/16x7/8 in	290.5 mm	1	ZZ-13/16-7/8
15/16x1 in	325.8 mm	1	ZZ-15/16-1
1x1 1/8 in	335.9 mm	1	ZZ-1-1.1/8
1 1/16x1 1/4 in	353 mm	1	ZZ-1.1/16-1.1/4

Imperial Offset Double Ring End Wrenches with Chrome Finish



1300Z

Size	Length (mm)	Quantity	Part No.
1/4x5/16 in	156 mm	1	1300Z-1/4-5/16
3/8x7/16 in	193 mm	1	1300Z-3/8-7/16
1/2x9/16 in	220 mm	1	1300Z-1/2-9/16
19/32x11/16 in	258 mm	1	1300Z-19/32-11/16
5/8x3/4 in	278 mm	1	1300Z-5/8-3/4
25/32x13/16 in	300 mm	1	1300Z-25/32-13/16
7/8x15/16 in	334 mm	1	1300Z-7/8-15/16
15/16x1 in	352 mm	1	1300Z-15/16-1
1x1 1/8 in	380 mm	1	1300Z-1-1.1/8

Metric Deep Offset Double Ring End Wrench Set - 8 Pcs/Box



2M/S

Quantity	Part No.
8	1 2M/S8

2M-6-7, 2M-8-9, 2M-10-11, 2M-12-13, 2M-14-15, 2M-16-17, 2M-18-19, 2M-20-22

Metric Deep Offset Double Ring End Wrench Set - 8 Pcs/Pouch



2M/T

Quantity	Part No.
8	1 2M/T8

2M-6-7, 2M-8-9, 2M-10-11, 2M-12-13, 2M-14-15, 2M-16-17, 2M-18-19, 2M-20-22

Metric Deep Offset Double Ring End Wrench Set - 10 Pcs/Pouch



2M/10T

Quantity	Part No.
10	1 2M/10T

2M-6-7, 2M-8-9, 2M-10-11, 2M-12-13, 2M-14-15, 2M-16-17, 2M-18-19, 2M-20-22, 2M-21-23, 2M-24-27

Metric Deep Offset Double Ring End Wrench Set - 12 Pcs/Pouch



2M/12T

12	1	2M/12T

2M-6-7, 2M-8-9, 2M-10-11, 2M-12-13, 2M-14-15, 2M-16-17, 2M-18-19, 2M-20-22, 2M-21-23, 2M-24-27, 2M-25-28, 2M-30-32

Imperial Deep Offset Double Ring End Wrench Set Black Plastic Pouch



2Z/T

7	1	2Z/T

2Z-1/4-5/16, 2Z-5/16-3/8, 2Z-3/8-7/16, 2Z-1/2-9/16, 2Z-9/16-5/8, 2Z-5/8-11/16, 2Z-3/4-7/8

Flat Double Ring End Wrenches with Chrome Finish



4M

6x7 mm	95 mm	10	4M-6-7
8x 9 mm	110 mm	10	4M-8-9
10x11 mm	125 mm	10	4M-10-11

12x13 mm	140 mm	10	4M-12-13
14x15 mm	155 mm	10	4M-14-15
16x17 mm	170 mm	10	4M-16-17
17x19 mm	170 mm	10	4M-17-19
18x19 mm	185 mm	10	4M-18-19
20x22 mm	205 mm	10	4M-20-22
21x23 mm	225 mm	5	4M-21-23
24x26 mm	250 mm	1	4M-24-26
24x27 mm	255 mm	1	4M-24-27
25x28 mm	275 mm	1	4M-25-28
27x29 mm	275 mm	1	4M-27-29
30x32 mm	300 mm	1	4M-30-32

Imperial Long Type Double Ring End Wrenches



44Z

1/4x5/16 in	197 mm	10	44Z-1/4-5/16
5/16x3/8 in	238 mm	10	44Z-5/16-3/8
3/8x7/16 in	284 mm	10	44Z-3/8-7/16
7/16x1/2 in	326 mm	10	44Z-7/16-1/2
1/2x9/16 in	358 mm	10	44Z-1/2-9/16
5/8x3/4 in	401 mm	5	44Z-5/8-3/4
11/16x3/4 in	401 mm	5	44Z-11/16-3/4
11/16x13/16 in	410 mm	5	44Z-11/16-13/16

Metric Starter and Manifold Flat Half Moon Box Wrenches with Double Ring End



1943M

11x13 mm	150 mm	1	1943M-11-13
13x15 mm	185 mm	1	1943M-13-15
13x17 mm	185 mm	1	1943M-13-17
14x17 mm	185 mm	1	1943M-14-17
15x17 mm	185 mm	1	1943M-15-17
19x22 mm	235 mm	1	1943M-19-22

Imperial Starter and Manifold Flat Half Moon Box Wrenches with Double Ring End



1943Z

5/16x3/8 in	153 mm	1	1943Z-5/16-3/8
7/16x1/2 in	153 mm	1	1943Z-7/16-1/2
9/16x5/8 in	186 mm	1	1943Z-9/16-5/8
5/8x3/4 in	233 mm	1	1943Z-5/8-3/4
11/16x13/16 in	233 mm	1	1943Z-11/16-13/16

Metric Flat Double Ring End Wrench Set Black Plastic Pouch



4M/T

10	1	4M/10T

4M-6-7, 4M-8-9, 4M-10-11, 4M-12-13, 4M-14-15, 4M-16-17, 4M-18-19, 4M-20-22, 4M-24-27, 4M-30-32

Metric Flat Double Ring End Wrench Set Grey Plastic Clip Pack



4M/C

10	1	4M/10C

4M-6-7, 4M-8-9, 4M-10-11, 4M-12-13, 4M-14-15, 4M-16-17, 4M-18-19, 4M-20-22, 4M-21-23, 4M-24-27



Metric Flat Double Ring End Wrench Set



4M/12C

12	1	4M/12C

4M-6-7, 4M-8-9, 4M-10-11, 4M-12-13, 4M-14-15, 4M-16-17, 4M-18-19, 4M-20-22, 4M-21-23, 4M-24-27, 4M-25-28, 4M-30-32

Metric Flat Double Ring End Wrench Set Standard Cardboard Box



4M/

8	1	4M/8

4M-6-7, 4M-8-9, 4M-10-11, 4M-12-13, 4M-14-15, 4M-16-17, 4M-18-19, 4M-20-22

FLARE NUT WRENCHES

Metric Double End Offset Flare Nut Wrenches with Chrome Finish



1949M

8x 9 mm	140 mm	1	1949M-8-9
10x11 mm	150 mm	1	1949M-10-11
10x12 mm	150 mm	1	1949M-10-12

12x13 mm	170 mm	1	1949M-12-13
12x14 mm	170 mm	1	1949M-12-14
14x15 mm	170 mm	1	1949M-14-15
14x17 mm	200 mm	1	1949M-14-17
17x19 mm	210 mm	1	1949M-17-19
19x22 mm	220 mm	1	1949M-19-22
22x24 mm	235 mm	1	1949M-22-24
24x27 mm	255 mm	1	1949M-24-27
30x32 mm	280 mm	1	1949M-30-32

Imperial Double End Offset Flare Nut Wrenches with Chrome Finish



1949Z

3/8x7/16 in	150 mm	1	1949Z-3/8-7/16
1/2x9/16 in	170 mm	1	1949Z-1/2-9/16
5/8x3/4 in	210 mm	1	1949Z-5/8-3/4
3/4x7/8 in	220 mm	1	1949Z-3/4-7/8
1x1 1/8 in	255 mm	1	1949Z-1-1.1/8

1/4" Square Drive Flare Nut Crowfoot Wrenches



679-

7 mm	1/4 in	1	679-7
8 mm	1/4 in	1	679-8
9 mm	1/4 in	1	679-9
10 mm	1/4 in	1	679-10
11 mm	1/4 in	1	679-11
12 mm	1/4 in	1	679-12
13 mm	1/4 in	1	679-13
14 mm	1/4 in	1	679-14
3/8 in	1/4 in	1	679-3/8
7/16 in	1/4 in	1	679-7/16
1/2 in	1/4 in	1	679-1/2
9/16 in	1/4 in	1	679-9/16

3/8" Square Drive Flare Nut Crowfoot Wrenches



749-

10 mm	3/8 in	10	749-10
11 mm	3/8 in	10	749-11
13 mm	3/8 in	10	749-13
14 mm	3/8 in	10	749-14
15 mm	3/8 in	1	749-15
16 mm	3/8 in	1	749-16
17 mm	3/8 in	1	749-17
18 mm	3/8 in	1	749-18
19 mm	3/8 in	1	749-19
20 mm	3/8 in	1	749-20
21 mm	3/8 in	1	749-21
22 mm	3/8 in	1	749-22
23 mm	3/8 in	1	749-23
24 mm	3/8 in	1	749-24
25 mm	3/8 in	1	749-25
26 mm	3/8 in	1	749-26
27 mm	3/8 in	1	749-27
3/8 in	3/8 in	1	749-3/8
7/16 in	3/8 in	1	749-7/16
1/2 in	3/8 in	1	749-1/2
9/16 in	3/8 in	1	749-9/16
5/8 in	3/8 in	1	749-5/8
11/16 in	3/8 in	1	749-11/16
3/4 in	3/8 in	1	749-3/4
13/16 in	3/8 in	1	749-13/16
7/8 in	3/8 in	1	749-7/8
15/16 in	3/8 in	1	749-15/16
1 in	3/8 in	1	749-1
1.1/16 in	3/8 in	1	749-1.1/16
1.1/8 in	3/8 in	1	749-1.1/8
1.3/16 in	3/8 in	1	749-1.3/16
1.1/4 in	3/8 in	1	749-1.1/4
1.5/16 in	3/8 in	1	749-1.5/16
1.3/8 in	3/8 in	1	749-1.3/8
1.7/16 in	3/8 in	1	749-1.7/16
1.1/2 in	3/8 in	1	749-1.1/2
1.9/16 in	3/8 in	1	749-1.9/16
1.5/8 in	3/8 in	1	749-1.5/8
1.11/16 in	3/8 in	1	749-1.11/16
1.3/4 in	3/8 in	1	749-1.3/4
1.13/16 in	3/8 in	1	749-1.13/16
1.7/8 in	3/8 in	1	749-1.7/8
1.15/16 in	3/8 in	1	749-1.15/16
2 in	3/8 in	1	749-2
2.1/8 in	3/8 in	1	749-2.1/8
2.3/16 in	3/8 in	1	749-2.3/16
2.1/4 in	3/8 in	1	749-2.1/4
2.3/8 in	3/8 in	1	749-2.3/8
2.5/8 in	3/8 in	1	749-2.5/8
2.3/4 in	3/8 in	1	749-2.3/4
3.1/8 in	3/8 in	1	749-3.1/8

1/2" Square Drive Flare Nut Crowfoot Wrenches



789-

Size	Size	Quantity	Part Number
28 mm	1/2 in	1	789-28
30 mm	1/2 in	1	789-30
32 mm	1/2 in	1	789-32
34 mm	1/2 in	1	789-34
36 mm	1/2 in	1	789-36
38 mm	1/2 in	1	789-38
40 mm	1/2 in	1	789-40
41 mm	1/2 in	1	789-41
42 mm	1/2 in	1	789-42
46 mm	1/2 in	1	789-46
50 mm	1/2 in	1	789-50
1.1/8 in	1/2 in	1	789-1.1/8
1.1/4 in	1/2 in	1	789-1.1/4
1.5/16 in	1/2 in	1	789-1.5/16
1.3/8 in	1/2 in	1	789-1.3/8
1.7/16 in	1/2 in	1	789-1.7/16
1.1/2 in	1/2 in	1	789-1.1/2
1.9/16 in	1/2 in	1	789-1.9/16
1.5/8 in	1/2 in	1	789-1.5/8
1.3/4 in	1/2 in	1	789-1.3/4
1.13/16 in	1/2 in	1	789-1.13/16
2 in	1/2 in	1	789-2
2.1/4 in	1/2 in	1	789-2.1/4
2.5/16 in	1/2 in	1	789-2.5/16
2.3/8 in	1/2 in	1	789-2.3/8

3/8" Square Drive Crowfoot Adjustable Wrenches



1950MZ

Size	Quantity	Part Number
0-29/0-1.1/8 in	1	1950MZ-3/8

SLOGGING WRENCHES

Metric Ring End Slogging Wrenches



7444SG-M

Size	Quantity	Part Number
24 mm	1	7444SG-M-24
27 mm	1	7444SG-M-27
30 mm	1	7444SG-M-30
32 mm	1	7444SG-M-32
34 mm	1	7444SG-M-34
36 mm	1	7444SG-M-36
38 mm	1	7444SG-M-38
41 mm	1	7444SG-M-41
42 mm	1	7444SG-M-42
46 mm	1	7444SG-M-46
50 mm	1	7444SG-M-50
55 mm	1	7444SG-M-55
60 mm	1	7444SG-M-60
65 mm	1	7444SG-M-65
70 mm	1	7444SG-M-70
75 mm	1	7444SG-M-75
80 mm	1	7444SG-M-80
85 mm	1	7444SG-M-85
90 mm	1	7444SG-M-90
95 mm	1	7444SG-M-95
100 mm	1	7444SG-M-100
105 mm	1	7444SG-M-105
110 mm	1	7444SG-M-110
115 mm	1	7444SG-M-115
120 mm	1	7444SG-M-120
125 mm	1	7444SG-M-125
130 mm	1	7444SG-M-130
135 mm	1	7444SG-M-135
140 mm	1	7444SG-M-140
145 mm	1	7444SG-M-145
150 mm	1	7444SG-M-150
155 mm	1	7444SG-M-155
160 mm	1	7444SG-M-160
165 mm	1	7444SG-M-165
170 mm	1	7444SG-M-170
175 mm	1	7444SG-M-175

Imperial Ring End Slogging Wrenches



7444SG-Z

Size	Quantity	Part Number
1 1/16 in	1	7444SG-Z-1.1/16
1 1/8 in	1	7444SG-Z-1.1/8
1 3/16 in	1	7444SG-Z-1.3/16

Size	Quantity	Part Number
1 1/4 in	1	7444SG-Z-1.1/4
1 5/16 in	1	7444SG-Z-1.5/16
1 3/8 in	1	7444SG-Z-1.3/8
1 7/16 in	1	7444SG-Z-1.7/16
1 1/2 in	1	7444SG-Z-1.1/2
1 5/8 in	1	7444SG-Z-1.5/8
1 11/16 in	1	7444SG-Z-1.11/16
1 3/4 in	1	7444SG-Z-1.3/4
1 13/16 in	1	7444SG-Z-1.13/16
1 7/8 in	1	7444SG-Z-1.7/8
2 in	1	7444SG-Z-2
2 1/16 in	1	7444SG-Z-2.1/16
2 1/8 in	1	7444SG-Z-2.1/8
2 3/16 in	1	7444SG-Z-2.3/16
2 1/4 in	1	7444SG-Z-2.1/4
2 3/8 in	1	7444SG-Z-2.3/8
2 9/16 in	1	7444SG-Z-2.9/16
2 5/8 in	1	7444SG-Z-2.5/8
2 3/4 in	1	7444SG-Z-2.3/4
3 in	1	7444SG-Z-3
3 1/8 in	1	7444SG-Z-3.1/8
3 3/8 in	1	7444SG-Z-3.3/8
3 1/2 in	1	7444SG-Z-3.1/2
3 3/4 in	1	7444SG-Z-3.3/4
3 7/8 in	1	7444SG-Z-3.7/8
4 in	1	7444SG-Z-4
4 1/8 in	1	7444SG-Z-4.1/8
4 1/2 in	1	7444SG-Z-4.1/2

Metric Open End Slogging Wrenches



133SGM

Size	Quantity	Part Number
27 mm	1	133SGM-27
30 mm	1	133SGM-30
32 mm	1	133SGM-32
36 mm	1	133SGM-36
41 mm	1	133SGM-41
46 mm	1	133SGM-46
50 mm	1	133SGM-50
55 mm	1	133SGM-55
60 mm	1	133SGM-60
65 mm	1	133SGM-65
70 mm	1	133SGM-70
75 mm	1	133SGM-75
80 mm	1	133SGM-80
85 mm	1	133SGM-85
90 mm	1	133SGM-90
95 mm	1	133SGM-95
100 mm	1	133SGM-100
105 mm	1	133SGM-105
110 mm	1	133SGM-110
115 mm	1	133SGM-115
120 mm	1	133SGM-120



Metric Deep Offset Ring End Slogging Wrenches



315M

Size	Quantity	Part Number
27 mm	1	315M-27
30 mm	1	315M-30
32 mm	1	315M-32
36 mm	1	315M-36
41 mm	1	315M-41
46 mm	1	315M-46
50 mm	1	315M-50
55 mm	1	315M-55
60 mm	1	315M-60
65 mm	1	315M-65
70 mm	1	315M-70
75 mm	1	315M-75
80 mm	1	315M-80

Imperial Deep Offset Ring End Slogging Wrenches



315Z

Size	Quantity	Part Number
1.1/16 in	1	315Z-1.1/16
1.1/8 in	1	315Z-1.1/8
1.3/16 in	1	315Z-1.3/16
1.1/4 in	1	315Z-1.1/4
1.5/16 in	1	315Z-1.5/16
1.3/8 in	1	315Z-1.3/8
1.7/16 in	1	315Z-1.7/16
1.1/2 in	1	315Z-1.1/2
1.5/8 in	1	315Z-1.5/8
1.11/16 in	1	315Z-1.11/16
1.3/4 in	1	315Z-1.3/4
1.13/16 in	1	315Z-1.13/16
1.7/8 in	1	315Z-1.7/8
1.15/16 in	1	315Z-1.15/16
2 mm	1	315Z-2
2.1/16 in	1	315Z-2.1/16
2.1/8 in	1	315Z-2.1/8
2.3/16 in	1	315Z-2.3/16
2.1/4 in	1	315Z-2.1/4
2.5/16 in	1	315Z-2.5/16
2.3/8 in	1	315Z-2.3/8
2.1/2 in	1	315Z-2.1/2
2.9/16 in	1	315Z-2.9/16
2.5/8 in	1	315Z-2.5/8

Size	Quantity	Part Number
2.3/4 in	1	315Z-2.3/4
2.7/8 in	1	315Z-2.7/8
2.15/16 in	1	315Z-2.15/16
3 mm	1	315Z-3
3.1/8 in	1	315Z-3.1/8

Metric Deep Offset Heavy Duty Ring End Wrenches



310M

Size	Quantity	Part Number
24 mm	1	310M-24
27 mm	1	310M-27
30 mm	1	310M-30
32 mm	1	310M-32
36 mm	1	310M-36
38 mm	1	310M-38
41 mm	1	310M-41
46 mm	1	310M-46
50 mm	1	310M-50
55 mm	1	310M-55
60 mm	1	310M-60
65 mm	1	310M-65
70 mm	1	310M-70
75 mm	1	310M-75
80 mm	1	310M-80
85 mm	1	310M-85
90 mm	1	310M-90
95 mm	1	310M-95

Extension Tubular Handles for 310M Ring Wrench



R310

Size 1	Size 2	Quantity	Part Number
24-30 mm	19 mm	1	R310-0
32-41 mm	22 mm	1	R310-1
46-55 mm	25 mm	1	R310-2
60-95 mm	30 mm	1	R310-3

SOCKET WRENCHES

Metric Double Head Offset Socket Wrenches with 12 x 6-Point Dynamic-Drive™



28M

Size 1	Size 2	Quantity	Part Number
6 mm	6 mm	5	28M-6
7 mm	7 mm	5	28M-7
8 mm	8 mm	5	28M-8
9 mm	9 mm	5	28M-9
10 mm	10 mm	5	28M-10
11 mm	11 mm	5	28M-11
12 mm	12 mm	5	28M-12
13 mm	13 mm	5	28M-13
14 mm	14 mm	5	28M-14
15 mm	15 mm	5	28M-15
16 mm	16 mm	5	28M-16
17 mm	17 mm	5	28M-17
18 mm	18 mm	3	28M-18
19 mm	19 mm	3	28M-19
20 mm	20 mm	3	28M-20
21 mm	21 mm	3	28M-21
22 mm	22 mm	3	28M-22
23 mm	23 mm	3	28M-23
24 mm	24 mm	3	28M-24
25 mm	25 mm	3	28M-25
26 mm	26 mm	3	28M-26
27 mm	27 mm	3	28M-27
28 mm	28 mm	1	28M-28
29 mm	29 mm	1	28M-29
30 mm	30 mm	1	28M-30
32 mm	32 mm	1	28M-32
6 mm	6 mm	10	SB28M-6
7 mm	7 mm	10	SB28M-7
8 mm	8 mm	10	SB28M-8
9 mm	9 mm	10	SB28M-9
10 mm	10 mm	10	SB28M-10
11 mm	11 mm	10	SB28M-11
12 mm	12 mm	10	SB28M-12
13 mm	13 mm	10	SB28M-13
14 mm	14 mm	10	SB28M-14
15 mm	15 mm	10	SB28M-15
16 mm	16 mm	5	SB28M-16
17 mm	17 mm	5	SB28M-17
18 mm	18 mm	5	SB28M-18
19 mm	19 mm	5	SB28M-19
20 mm	20 mm	4	SB28M-20
21 mm	21 mm	4	SB28M-21
22 mm	22 mm	4	SB28M-22
23 mm	23 mm	4	SB28M-23
24 mm	24 mm	4	SB28M-24

Metric Double Head Offset Socket Wrenches with 6 x 6-Point Dynamic-Drive™



29M



6 mm	5	29M-6
7 mm	5	29M-7
8 mm	5	29M-8
9 mm	5	29M-9
10 mm	5	29M-10
11 mm	5	29M-11
12 mm	5	29M-12
13 mm	5	29M-13
14 mm	5	29M-14
15 mm	5	29M-15
16 mm	5	29M-16
17 mm	5	29M-17
18 mm	3	29M-18
19 mm	3	29M-19
20 mm	3	29M-20
21 mm	3	29M-21
22 mm	3	29M-22
23 mm	3	29M-23
24 mm	3	29M-24
25 mm	3	29M-25
26 mm	3	29M-26
27 mm	3	29M-27
28 mm	1	29M-28
29 mm	1	29M-29
30 mm	1	29M-30
32 mm	1	29M-32

Metric Double Head Offset Socket Wrench Set with 12 x 6-Point Dynamic-Drive™ - 11 Pcs



28M/11



11	1	28M/11
----	---	--------

28M-8, 28M-9, 28M-10, 28M-11, 28M-13, 28M-12, 28M-14, 28M-15, 28M-17, 28M-19, 28M-22



Metric Double Head Offset Socket Wrench Set with 6 x 6-Point Dynamic-Drive™ - 8 Pcs



29M/



8	1	29M/8
---	---	-------

29M-8, 29M-10, 29M-12, 29M-13, 29M-14, 29M-17, 29M-19, 29M-22



Metric Double Head Offset Socket Wrench Set with 12 x 6-Point Dynamic-Drive™ - 12 Pcs



28M/12



12	1	28M/12
----	---	--------

28M-8, 28M-9, 28M-10, 28M-11, 28M-12, 28M-13, 28M-14, 28M-15, 28M-16, 28M-17, 28M-18, 28M-19



Metric Double Head Offset Socket Wrench Set with 6 x 6-Point Dynamic-Drive™ - 10 Pcs



29M/10



10	1	29M/10
----	---	--------

29M-8, 29M-10, 29M-11, 29M-12, 29M-13, 29M-14, 29M-16, 29M-17, 29M-18, 29M-19



Metric Double Head Offset Socket Wrench Set with 12 x 6-Point Dynamic-Drive™ - 8 Pcs



28M/



8	1	28M/8
---	---	-------

28M-8, 28M-10, 28M-11, 28M-13, 28M-16, 28M-17, 28M-18, 28M-19



Metric Double Head Offset Socket Wrench Set with 12 x 6-Point Dynamic-Drive™ - 15 Pcs



28M/15



15	1	28M/15
----	---	--------

28M-8, 28M-9, 28M-10, 28M-11, 28M-12, 28M-13, 28M-14, 28M-15, 28M-16, 28M-17, 28M-18, 28M-19, 28M-21, 28M-22, 28M-24



Metric Double Head Offset Socket Wrench Set with 6 x 6-Point Dynamic-Drive™ - 14 Pcs



29M/14



14	1	29M/14
----	---	--------

29M-11, 29M-12, 29M-13, 29M-14, 29M-8, 29M-9, 29M-10, 29M-16, 29M-17, 29M-21, 29M-22, 29M-19, 29M-24, 29M-23



Metric Tubular Double Head Socket Wrench



1936M

Size	Quantity	Part Number
6x7 mm	50	1936M-6-7
8x9 mm	5	1936M-8-9
8x10 mm	30	1936M-8-10
10x11 mm	25	1936M-10-11
10x13 mm	25	1936M-10-13
12x13 mm	25	1936M-12-13
13x17 mm	20	1936M-13-17
14x15 mm	20	1936M-14-15
14x17 mm	15	1936M-14-17
16x17 mm	15	1936M-16-17
17x19 mm	10	1936M-17-19
18x19 mm	10	1936M-18-19
19x22 mm	8	1936M-19-22
20x22 mm	8	1936M-20-22
21x23 mm	8	1936M-21-23
22x24 mm	5	1936M-22-24
24x26 mm	5	1936M-24-26
24x27 mm	5	1936M-24-27
25x28 mm	5	1936M-25-28
30x32 mm	1	1936M-30-32
30x34 mm	4	1936M-30-34
36x41 mm	4	1936M-36-41
46x50 mm	2	1936M-46-50

Size	Quantity	Part Number
24x27* mm	5	27M-24-27
25x28* mm	5	27M-25-28
27x29* mm	5	27M-27-29
30x32* mm	5	27M-30-32
6x7 mm	10	SB27M-6-7
8x9 mm	10	SB27M-8-9
10x11 mm	10	SB27M-10-11
12x13 mm	10	SB27M-12-13
14x15 mm	10	SB27M-14-15
16x17* mm	10	SB27M-16-17
18x19* mm	10	SB27M-18-19
20x22* mm	10	SB27M-20-22
21x23* mm	5	SB27M-21-23
24x26* mm	5	SB27M-24-26

Sizes marked with * in the table have a hole along the shank

Metric Tubular Double Head Socket Wrench Set with Chrome Finish - 7 Pcs



1936M/

Size	Quantity	Part Number
7	1	1936M/7

Size	Quantity	Part Number
1936M-8-9, 1936M-10-11, 1936M-12-13, 1936M-14-15, 1936M-16-17, 1936M-18-19, 1936M-20-22		
26S-610		

Metric Double Head Socket Wrenches with Chrome Finish



27M

Size	Quantity	Part Number
6x7 mm	10	27M-6-7
8x9 mm	10	27M-8-9
10x11 mm	10	27M-10-11
12x13 mm	10	27M-12-13
13x17* mm	10	27M-13-17
14x15 mm	10	27M-14-15
16x17* mm	10	27M-16-17
16x18* mm	10	27M-16-18
18x19* mm	10	27M-18-19
20x22* mm	10	27M-20-22
21x23* mm	5	27M-21-23
21x24* mm	5	27M-21-24
24x26* mm	5	27M-24-26

Metric Tubular Double Head Socket Wrench Set with Chrome Finish - 12 Pcs



1936M/12

Size	Quantity	Part Number
12	1	1936M/12

Size	Quantity	Part Number
1936M-6-7, 1936M-8-9, 1936M-10-11, 1936M-12-13, 1936M-14-15, 1936M-16-17, 1936M-18-19, 1936M-20-22, 1936M-21-23, 1936M-24-27, 1936M-25-28, 1936M-30-32		
26S-610, 26S-1216, 26S-16		

Metric Double Head Socket Wrench Set - 8 Pcs/Plastic Pouch



27M/T

Size	Quantity	Part Number
8	1	27M/8T

Size	Quantity	Part Number
27M-6-7, 27M-8-9, 27M-10-11, 27M-12-13, 27M-14-15, 27M-16-17, 27M-18-19, 27M-20-22		

Metric Double Head Socket Wrench Set - 12 Pcs/Plastic Pouch



27M/12T

Size	Quantity	Part Number
12	1	27M/12T

Size	Quantity	Part Number
27M-6-7, 27M-8-9, 27M-10-11, 27M-12-13, 27M-14-15, 27M-16-17, 27M-18-19, 27M-20-22, 27M-21-23, 27M-24-26, 27M-25-28, 27M-30-32		

Metric Double Head Socket Wrench Set - 6 Pcs/Cardboard Box



27M/

Size	Quantity	Part Number
6	1	27M/6

Size	Quantity	Part Number
27M-6-7, 27M-8-9, 27M-10-11, 27M-12-13, 27M-14-15, 27M-16-17		

Metric Double Head Socket Wrench Set - 8 Pcs/Cardboard Box



27M/8

8	1	27M/8

27M-6-7, 27M-8-9, 27M-10-11, 27M-12-13, 27M-14-15, 27M-16-17, 27M-18-19, 27M-20-22



Metric Double Head Socket Wrench Set - 10 Pcs/Cardboard Box



27M/10

10	1	27M/10

27M-6-7, 27M-8-9, 27M-10-11, 27M-12-13, 27M-14-15, 27M-16-17, 27M-18-19, 27M-20-22, 27M-21-23, 27M-24-26



Metric Double Head Socket Wrench Set - 12 Pcs/Cardboard Box



27M/12

12	1	27M/12

27M-6-7, 27M-8-9, 27M-10-11, 27M-12-13, 27M-14-15, 27M-16-17, 27M-18-19, 27M-20-22, 27M-21-23, 27M-24-26, 27M-25-28, 27M-30-32



Stepped Tommy Bars with Chrome Finish



26S

6 8 10 mm	10	26S-610
12 14 mm	8	26S-1216
16 mm	5	26S-16

Metric Swivel Head Double End Wrenches with Bi-Hex Socket



4040M

6x7 mm	1	4040M-6-7
8x9 mm	1	4040M-8-9
10x11 mm	1	4040M-10-11
10x13 mm	1	4040M-10-13
12x13 mm	1	4040M-12-13
13x17 mm	1	4040M-13-17
14x15 mm	1	4040M-14-15
16x17 mm	1	4040M-16-17
16x18 mm	1	4040M-16-18
18x19 mm	1	4040M-18-19
20x22 mm	1	4040M-20-22
21x23 mm	1	4040M-21-23

Imperial Swivel Head Double End Wrenches with Bi-Hex Socket



4040Z

3/8x7/16 in	1	4040Z-3/8-7/16
1/2x9/16 in	1	4040Z-1/2-9/16
5/8x11/16 in	1	4040Z-5/8-11/16
5/8x3/4 in	1	4040Z-5/8-3/4
13/16x7/8 in	1	4040Z-13/16-7/8

Metric Double Ended Swivel Head Wrench Set with Bi-Hex Socket



4040M/S6

6	1	4040M/S6

4040M-8-9, 4040M-10-11, 4040M-12-13, 4040M-14-15, 4040M-16-17, 4040M-18-19



Metric Double Ended Swivel Head Wrench Set with Bi-Hex Socket Plastic Wallet



4040M/6T

6	1	4040M/6T

4040M-8-9, 4040M-10-11, 4040M-12-13, 4040M-14-15, 4040M-16-17, 4040M-18-19



MULTIFITTING KEYS

5-in-1 Switch Cabinet Wrenches



MK5

97x25 mm	1	MK5

Square: 5,6,7-8 mm, Triangular: 9 mm Two-way-key: 3-5 mm



9-in-1 Switch Cabinet Wrenches



MK9



95x95 mm



1 MK9

Square: 5,6,7-8,9-10 mm, Triangular:7,8-9,10-11 mm Two-way-key: 3-5 mm
Half-moon: 6 mm

HOOK WRENCHES

Flexible Head Adjustable Hook Wrenches with Chrome Finish



4106



19-50 mm

32-75 mm

50-120 mm

115-165 mm

150-230 mm



10 4106-19-50

25 4106-32-75

25 4106-50-120

25 4106-115-165

10 4106-150-230

Adjustable Pin Hook Wrenches with Chrome Finish



40B



19-50 mm

32-75 mm

50-120 mm

115-165 mm

150-230 mm



25 40B-19-50

25 40B-32-75

20 40B-50-120

25 40B-115-165

10 40B-150-230

Adjustable Pin Wrenches with Chrome Finish



4307/4310



10-50 mm

22-100 mm



1 4307

1 4310

Spare Pin for Adjustable Pin Hook Wrenches



40B-SP



40B-19-50

40B-32-75

40B-50-120

40B-115-165



1 40B-19-50-SP

1 40B-32-75-SP

1 40B-50-120-SP

1 40B-115-165-SP



Sockets & Ratchets



SOCKET SETS

1/4" and 1/2" Square Drive Socket and Deep Socket Set with Metric Hex Profile and Combination Spanner Set



S910



110 x 320 x 375 mm

2 S910

Socket Set with Combination Wrenches, Hex L-Keys and Bits - 96 Pcs



S95



110 x 320 x 375 mm

2 S95

1/4" and 1/2" Square Drive Combination Spanner and Socket Set



S87+7



110 x 430 x 375 mm

2 S87+7

1 pce removable three section plastic box with lid

1/4" and 1/2" Square Drive Socket Set with Combination Spanner Set/L-Keys



S106



110 x 430 x 375 mm

2 S106

1/4" and 1/2" Square Drive Socket Set with Metric Hex Profile and Combination Wrench/Bit Set/Pliers



S81MIX



110 x 430 x 375 mm

2 S81MIX

1/4" and 1/2" Square Drive Socket Set with Combination Spanner Set



S103



110 x 375 x 430 mm

2 S103

1/4" and 1/2" Square Drive Socket Set with Metric Hex Profile and Combination Spanner Set



S410

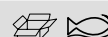

110 x 320 x 375 mm

2 S410

1/4" and 1/2" Square Drive Socket Set with Combination Spanner Set/Socket Drivers



S108



110 x 430 x 375 mm

2 S108

1/4" and 1/2" Square Drive Spanner and Socket Set



S800



110 x 375 x 430 mm

2 S800

1/4" and 1/2" Square Drive Socket Set with Metric Hex Profile and Swivel Head Ratchet - 79 Pcs



SW79



100 x 215 x 370 mm

4 SW79

1/4" 3/8" and 1/2" Square Drive Socket Set with Combination Wrenches/Screwdriver Bits



S138



110 x 375 x 430 mm

2 S138

1/4" Square Drive Deep Socket Set with Metric Hex Profile



S0810L



35 x 85 x 160 mm

20 S0810L

1/4" and 1/2" Square Drive Socket Set with Metric Bi-Hex Profile and Slim Head Ratchet



S560



100 x 215 x 375 mm

4 S560

1/4" - 3/8" - 1/2" Square Drive Socket Set with Metric Hex Profile with Gear Wrenches Set - 137 Pcs



S137



105 x 370 x 430 mm

2 S137

1/4" Square Drive Socket Set with Metric Hex Profile and Screwdriver Bits/Bit Holder



SL25



35 x 85 x 160 mm

20 SL25

1/4" and 3/8" Square Drive Socket Set with Metric Hex Profile and Swivel Head Ratchet - 91 Pcs



SW91



100 x 215 x 370 mm

4 SW91

1/4" and 1/2" Square Drive Socket and Deep Socket Set with Metric Hex Profile and Combination Spanner Set - 92 Pcs



S910AF



110 x 320 x 370 mm

2 S910AF

1/4" Square Drive Socket Set with Metric Hex Profile and Screwdriver Bits/Bit Holder, 25 Pcs/Case Retail Pack



SBSL25



55 x 80 x 165 mm

5 SBSL25

SBS81



SBS61



1/4" Square Drive Socket Set with Metric Hex Profile and Screwdriver Bits



SL24



35 x 85 x 160 mm



1 SL24

1/4" Square Drive Socket Set with Metric Hex Profile and Ratchet/Socket Drivers



S290



70 x 160 x 280 mm



6 S290

1/4" Square Drive Socket Set with Metric Hex Profile and Swivel Head Ratchet - 65 Pcs



SW65



70 x 160 x 280 mm



6 SW65

1/4" Square Drive Socket and Deep Socket Set with Metric Hex Profile and Screwdriver Bits



SL25L



46 x 130 x 195 mm



10 SL25L

1/4" Square Drive Socket Set with Metric Hex Profile and Socket Drivers



S460



100 x 215 x 375 mm



6 S460

1/4" Square Drive Socket Set with Imperial Hex Profile and Screwdriver Bits/Bit Holder



SL25AF



35 x 85 x 165 mm



20 SL25AF

1/4" Square Drive Socket Set with Metric Hex Profile and Ratchet



S160



70 x 160 x 280 mm



6 S160

1/4" Square Drive Socket Set with Metric Hex Profile and Slim Head Ratchet - 65 Pcs



SL65



70 x 160 x 280 mm



6 SL65

1/4" Square Drive Socket Set with Imperial Hex Profile and Ratchet



S160AF



70 x 160 x 280 mm



6 S160AF

1/4" Square Drive Socket Set with Metric Hex Profile and Pear Head Ratchet



6712R

31 x 110 x 178 mm	1 6712R

6700SM-4, 6700SM-5, 6700SM-5.5, 6700SM-6, 6700SM-7, 6700SM-8, 6700SM-10, 6700SM-11, 6700SM-13	
6950	
6960, 6962	

1/4" Square Drive Socket Set with Metric Hex Profile and Round Head Ratchet



6712RN

31 x 108 x 178 mm	1 6712RN

6700SM-4, 6700SM-5, 6700SM-5.5, 6700SM-6, 6700SM-7, 6700SM-8, 6700SM-10, 6700SM-11, 6700SM-13	
6960, 6962	
6950RN	

1/4" Square Drive Socket Set with Metric Bi-Hex Profile and Pear Head Ratchet



A6716DM

35 x 111 x 223 mm	1 A6716DM

A6700DM-5.5, A6700DM-6, A6700DM-7, A6700DM-8, A6700DM-9, A6700DM-10, A6700DM-11, A6700DM-12, A6700DM-13, A6700DM-14	
6956	
6962	
6966	
6954	
6950	

1/4" Square Drive Socket Set with Metric Hex Profile and Round Head Ratchet/ Extension Bars



6715MGS

34 x 113 x 223 mm	1 6715MGS

SB6700SM-4, 6700SM-4.5, 6700SM-5, 6700SM-5.5, 6700SM-6, 6700SM-7, 6700SM-8, 6700SM-9, 6700SM-10, 6700SM-11, 6700SM-13	
6954	
6950RN	
6956	
6966	
6962	

1/4" Square Drive Socket Set with Metric Hex Profile and Round Head Ratchet/T-Handle



6719MHR

50 x 110 x 220 mm	1 6719MHR

6700SM-4, 6700SM-4.5, 6700SM-5.5, 6700SM-5, 6700SM-6, 6700SM-7, 6700SM-8, 6700SM-9, 6700SM-10, 6700SM-11, 6700SM-12, 6700SM-13, 6700SM-14	
6950RN	
6960, 6962	
6954	
6956	
6966	

1/4" Square Drive Socket Set with Metric Hex Profile and Round Head Ratchet/ Screwdriver Bits/Adaptor



6729MHR

50 x 110 x 220 mm	1 6729MHR

6700SM-4, 6700SM-5, 6700SM-6, 6700SM-7, 6700SM-8, 6700SM-9, 6700SM-10, 6700SM-11, 6700SM-13, 6700SM-14	
6950RN	
6960, 6962	
6966	
6956	
6973A	
59S/PH1, 59S/PH2, 59S/PH3	
59S/PZ1, 59S/PZ2, 59S/PZ3	
59S/0.6-4.5, 59S/0.8-5.5, 59S/1.2-6.5	
59S/H3, 59S/H4, 59S/H5, 59S/H6	



1/4" Square Drive Socket Set with Metric Hex Profile and Pear Head Ratchet/ Screwdriver Bits/Adaptor



6729MHP

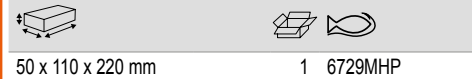

50 x 110 x 220 mm 1 6729MHP

6700SM-4, 6700SM-5, 6700SM-6, 6700SM-7, 6700SM-8, 6700SM-9, 6700SM-10, 6700SM-11, 6700SM-13, 6700SM-14		
6950		
6960, 6962		
6966		
6956		
6973A		
59S/0.6-4.5, 59S/0.8-5.5, 59S/1.2-6.5		
59S/PZ1, 59S/PZ2, 59S/PZ3		
59S/PH1, 59S/PH2, 59S/PH3		
59S/H3, 59S/H4, 59S/H5, 59S/H6		

1/4" Square Drive Socket Set with Metric Bi-Hex Profile and Pear Head Ratchet/ Extension Bars



6717MBP

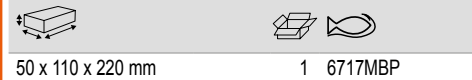

50 x 110 x 220 mm 1 6717MBP

A6700DM-5, A6700DM-5.5, A6700DM-6, A6700DM-7, A6700DM-8, A6700DM-9, A6700DM-10, A6700DM-11, A6700DM-12, A6700DM-13, A6700DM-14		
6950		
6960, 6962		
6954		
6966		
6956		

1/4" Square Drive Socket Set with Metric Bi-Hex Profile and Pear Head Ratchet/ Screwdriver Bits



6730MBP

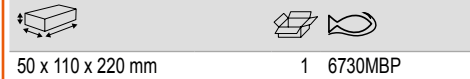

50 x 110 x 220 mm 1 6730MBP

A6700DM-5, A6700DM-5.5, A6700DM-6, A6700DM-7, A6700DM-8, A6700DM-9, A6700DM-10, A6700DM-11, A6700DM-12, A6700DM-13, A6700DM-14		
6950		
6960, 6962		
6954		
6966		
6956		
6973A		
59S/0.6-4.5, 59S/1.2-6.5, 59S/0.8-5.5		
59S/PH1, 59S/PH2, 59S/PH3		
59S/PZ1, 59S/PZ2, 59S/PZ3		
59S/H3, 59S/H4, 59S/H5, 59S/H6		

1/4" Square Drive Socket Set with Metric Hex Profile and Pear Head Ratchet/ Universal Joint



6719SM

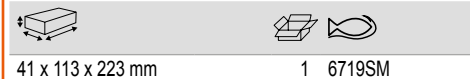

41 x 113 x 223 mm 1 6719SM

6700SM-4, 6700SM-4.5, 6700SM-5, 6700SM-5.5, 6700SM-6, 6700SM-7, 6700SM-8, 6700SM-9, 6700SM-10, 6700SM-11, 6700SM-12, 6700SM-13		
6954		
6950		
6956		
6966		
6962		

1/4" Square Drive Socket Set with Metric Hex Profile and Round Head Ratchet/ Breaker Bar



6715MG



35 x 111 x 223 mm 1 6715MG

6700SM-4, 6700SM-4.5, 6700SM-5, 6700SM-5.5, 6700SM-6, 6700SM-7, 6700SM-8, 6700SM-9, 6700SM-10, 6700SM-11, 6700SM-12, 6700SM-13, 6700SM-14		
6954		
6958		
6956		
6962, 6960		
6966		
6950RN		

1/4" Square Drive Socket Set with Metric Hex Profile and Pear Head Ratchet/ Adaptor



6721NM



41 x 113 x 223 mm 1 6721NM

6700SM-4, 6700SM-4.5, 6700SM-5, 6700SM-5.5, 6700SM-6, 6700SM-7, 6700SM-8, 6700SM-9, 6700SM-10, 6700SM-11, 6700SM-12, 6700SM-13, 6700SM-14		
6954		
6951		
6956		
6950		
6962, 6960		
6966		
6958		

1/4" Square Drive Socket Set with Metric Hex Profile and Pear Head Ratchet/Extension Bars



6722M

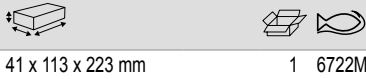

41 x 113 x 223 mm 1 6722M

6700SM-4, 6700SM-5, 6700SM-6, 6700SM-7, 6700SM-8, 6700SM-9, 6700SM-10, 6700SM-11, 6700SM-13, 6700SM-14		
6954		
6956		
6950		
6966		
6960, 6962		
6972H		
59S/H3, 59S/H4, 59S/H5, 59S/H6		
59S/PH1, 59S/PH2, 59S/PH3		

1/4" Square Drive Socket Set with Metric Hex Profile and Round Head Ratchet/Spinner Handle



6715GE



31 x 113 x 223 mm 1 6715GE

6700SM-4, 6700SM-5, 6700SM-6, 6700SM-7, 6700SM-8, 6700SM-9, 6700SM-10, 6700SM-11, 6700SM-13, 6700SM-14		
6956		
6950RN		
6954		
6966		
6960, 6962		
6972H		
59S/H3, 59S/H4, 59S/H5, 59S/H6		
59S/PH1, 59S/PH2, 59S/PH3		

1/4" Square Drive Socket Set with Metric Hex Profile and Pear Head Ratchet/Socket Drivers



6715PZ

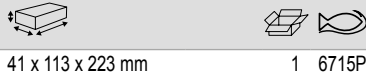

41 x 113 x 223 mm 1 6715PZ

6700SM-4, 6700SM-4.5, 6700SM-5, 6700SM-5.5, 6700SM-6, 6700SM-7, 6700SM-8, 6700SM-9, 6700SM-10, 6700SM-11, 6700SM-12, 6700SM-13		
6956		
6950		
6954		
6962, 6960		
6966		
6709F-4.5, 6709F-5.5, 6709F-8		
6709M-3, 6709M-4, 6709M-5, 6709M-6, 6709M-8		
6709PZ-1, 6709PZ-3, 6709PZ-2		

1/4" Square Drive Socket Set with Metric Hex Profile and Pear Head Ratchet/Screwdriver Bits



6715GJ



50 x 113 x 223 mm 1 6715GJ

6700SM-4, 6700SM-4.5, 6700SM-5, 6700SM-5.5, 6700SM-6, 6700SM-7, 6700SM-8, 6700SM-9, 6700SM-10, 6700SM-11, 6700SM-12, 6700SM-13		
6956		
6962, 6960		
6709F-4.5, 6709F-5.5, 6709F-8		
6709M-5, 6709M-6, 6709M-8, 6709M-4, 6709M-3		
6954		
6950		
6966		
6709PH-1, 6709PH-2, 6709PH-3		

1/4" Square Drive Socket Set with Metric Hex Profile and Pear Head Ratchet/Spanner Set



6720NM



43 x 114 x 351 mm 1 6720NM

6700SM-4, 6700SM-4.5, 6700SM-5, 6700SM-5.5, 6700SM-6, 6700SM-7, 6700SM-8, 6700SM-9, 6700SM-10, 6700SM-11, 6700SM-12, 6700SM-13, 6700SM-14		
1931M-4, 1931M-4.5, 1931M-9, 1931M-10, 1931M-11, 1931M-14, 1931M-13, 1931M-12, 1931M-7, 1931M-8, 1931M-6, 1931M-5.5, 1931M-5		
6954		
6950		
6956		
221 D		
73721-3-80		
6966		
6962		

1/4" Square Drive Socket Set with Imperial Bi-Hex Profile and Pear Head Ratchet



A6716DZ



41 x 113 x 223 mm 1 A6716DZ

A6700DZ-3/16, A6700DZ-7/32, A6700DZ-1/4, A6700DZ-9/32, A6700DZ-5/16, A6700DZ-11/32, A6700DZ-3/8, A6700DZ-7/16, A6700DZ-1/2, A6700DZ-9/16		
6956		
6962		
6966		
6954		
6950		



1/4" Socket Set with Imperial Bi-Hex Profile - 18 Pcs



A6718DZ

41 x 113 x 223 mm	1185 g	1	A6718DZ

6950	
6951	
6956	
6954	
6958	
6960, 6962	
6966	
A6700DZ-3/16, A6700DZ-7/32, A6700DZ-1/4, A6700DZ-9/32, A6700DZ-5/16, A6700DZ-11/32, A6700DZ-3/8, A6700DZ-7/16, A6700DZ-1/2, A6700DZ-9/16	

1/4" Square Drive Socket Set with Imperial Hex Profile and Pear Head Ratchet/Breaker Bars



6821NZ

50 x 113 x 223 mm		1	6821NZ

6700SZ-1/4, 6700SZ-11/32, 6700SZ-1/2, 6700SZ-3/16, 6700SZ-5/32, 6700SZ-7/32, 6700SZ-9/32, 6700SZ-5/16, 6700SZ-3/8, 6700SZ-7/16, 6700SZ-9/16	
6954	
6958	
6950	
6956	
6960, 6962	
6966	
6951	

1/4" Square Drive Socket Set with Metric/Imperial Hex Profile and Pear Head Ratchet



6715MZ

40 x 126 x 230 mm		1	6715MZ

6700SM-4, 6700SM-4.5, 6700SM-5, 6700SM-5.5, 6700SM-6, 6700SM-8, 6700SM-9, 6700SM-10, 6700SM-11, 6700SM-13	
6700SZ-7/32, 6700SZ-3/16, 6700SZ-1/4, 6700SZ-9/32, 6700SZ-5/16, 6700SZ-11/32, 6700SZ-3/8, 6700SZ-7/16, 6700SZ-1/2	
6954	
6950	
6956	
6966	
6962	

1/4" Square Drive Deep Socket 9-piece set for Metric and imperial Hex Head Screw



A6709MZ/9

46 x 130 x 195 mm		1	A6709MZ/9

A6709M-2.5, A6709M-3, A6709M-4, A6709M-5, A6709M-6	
A6709Z-1/8, A6709Z-9/64, A6709Z-5/32, A6709Z-3/16	
SPAR-CASE-A6	

1/4" Square Drive Socket Set with Metric Hex Profile and Spinner Handle



6729SM

25 x 55 x 190 mm		1	6729SM

6700SM-4, 6700SM-4.5, 6700SM-5, 6700SM-5.5, 6700SM-6, 6700SM-7, 6700SM-8, 6700SM-9, 6700SM-10, 6700SM-11, 6700SM-12, 6700SM-13, 6700SM-14	
6956	

1/4" Square Drive Socket Set with Imperial Hex Profile and Spinner Handle



6729SZ

25 x 55 x 190 mm		1	6729SZ

6700SZ-1/4, 6700SZ-11/32, 6700SZ-1/2, 6700SZ-3/16, 6700SZ-7/32, 6700SZ-3/8, 6700SZ-7/16	
6956	

1/4" Square Drive Socket Set with Metric Hex Profile



6713MH

13		1	6713MH

6700SM-4, 6700SM-4.5, 6700SM-5, 6700SM-5.5, 6700SM-6, 6700SM-7, 6700SM-8, 6700SM-9, 6700SM-10, 6700SM-11, 6700SM-12, 6700SM-13, 6700SM-14	
---	--

1/4" Square Drive Deep Socket Set on Rail with Metric Bi-Hex Profile



6708DMB



8 1 6708DMB

A6800DM-6, A6800DM-7, A6800DM-8, A6800DM-9, A6800DM-10, A6800DM-11, A6800DM-12, A6800DM-13



1/4" Square Drive Socket Set with Metric Bi-Hex Profile



6711MB



11 1 6711MB

A6700DM-5, A6700DM-5.5, A6700DM-6, A6700DM-7, A6700DM-8, A6700DM-9, A6700DM-10, A6700DM-11, A6700DM-12, A6700DM-13, A6700DM-14



1/4" Square Drive Socket Set with TORX® Head Screw



6706TE



6 1 6706TE

6700TORX-E4, 6700TORX-E5, 6700TORX-E6, 6700TORX-E7, 6700TORX-E8, 6700TORX-E10



1/4" Square Drive Socket Set with Metric Hex Profile and Refrigeration Ratchet



R6725MK



26 x 105 x 175 mm 1 R6725MK

6700SM-7, 6700SM-8, 6700SM-10

6954

R6967

R6810M-3,4, R6810M-4, R6810M-4,5, R6810M-5, R6810M-6, R6810M-7, R6810M-8, R6810M-9, R6810M-10

6966

R6950

6962

R6964A

1/4" Square Drive Socket Set with Imperial Hex Profile and Refrigeration Ratchet



R6725ZK



48 x 115 x 225 mm 1 R6725ZK

6700SZ-1/4, 6700SZ-5/16, 6700SZ-11/32, 6700SZ-3/8, 6700SZ-7/16, 6700SZ-1/2

6954

R6967

R6950

6962

R6810M-6

R6964A

6966

R6810Z-3/16, R6810Z-7/32, R6810Z-1/4, R6810Z-5/16, R6810Z-3/8

R6822Z

3/8" Square Drive Deep Socket Set



S1214L



49 x 152 x 280 mm 10 S1214L

1/4" and 3/8" Square Drive Socket Set with Metric Hex Profile and Ratchet



S330



70 x 160 x 280 mm 6 S330

1/4" and 3/8" Square Drive Deep Socket Set with Metric Hex Profile and Ratchet



S330L

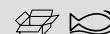

100 x 215 x 375 mm 4 S330L



3/8" Square Drive Socket Set with Metric/Imperial Hex Profile



S380



100 x 215 x 375 mm

4 S380

3/8" Socket Set - 34 Pcs



SL34



70 x 160 x 280 mm

6 SL34

Pass-Through Socket Set with Flexi Head Ratchet/Extension Bars



S140T



65 x 160 x 280 mm

1 S140T

1 pc pass-through extension bar, 75 mm

SBS19-THR

SBS19-TH75

SBS19-TH10, SBS19-TH11, SBS19-TH12, SBS19-TH13, SBS19-TH14, SBS19-TH15, SBS19-TH16, SBS19-TH17, SBS19-TH18, SBS19-TH19, SBS19-TH21, SBS19-TH22, SBS19-TH24

SBS19-TH20

Pass-Through Ratchet Set with Hex to Square Drive Adaptors



S140T-R



121 x 280 x 220 mm

10 S140T-R

SBS19-THR

1RMA-19-3/8-SQ

1RMA-19-1/2-SQ



Pass-Through Socket Set with Flexi Head Ratchet/Adaptors



S530T



90 x 205 x 370 mm

4 S530T

1/4" and 3/8" Square Drive Socket Set with Imperial Hex Profile and Ratchet



S330AF



70 x 160 x 280 mm

6 S330AF

3/8" Square Drive Socket Set with Metric Bi-Hex Profile and Round Head Ratchet/Extension Bars



A7435DME



40 x 150 x 500 mm

1 A7435DME

A7400DM-9, A7400DM-10, A7400DM-11, A7400DM-12, A7400DM-13, A7400DM-14, A7400DM-15, A7400DM-16, A7400DM-17, A7400DM-18, A7400DM-19, A7400DM-20, A7400DM-21, A7400DM-22



7755-3/8



7754



7760, 7762, 7761



7758



7752



7766



3/8" Square Drive Socket Set with Metric Bi-Hex Profile and Round Head Ratchet/Breaker Bar



A7440DME



50 x 115 x 312 mm

1 A7440DME

7755-3/8



7758



7761



A7400DM-9, A7400DM-12, A7400DM-13, A7400DM-14, A7400DM-15, A7400DM-16, A7400DM-17, A7400DM-10, A7400DM-11, A7400DM-22, A7400DM-20, A7400DM-21, A7400DM-18, A7400DM-19



3/8" Square Drive Socket Set with Metric Bi-Hex Profile and Round Head Ratchet



7422MBR



60 x 220 x 280 mm

1 7422MBR

A7400DM-6, A7400DM-7, A7400DM-8, A7400DM-9, A7400DM-10, A7400DM-11, A7400DM-12, A7400DM-13, A7400DM-14, A7400DM-15, A7400DM-16, A7400DM-17, A7400DM-18, A7400DM-19, A7400DM-20, A7400DM-21, A7400DM-22



7750RN



7760, 7762



7754



7766



3/8" Square Drive Socket Set with Metric Hex Profile and Round Head Ratchet/T-Handle



7422MHR



50 x 160 x 350 mm

1 7422MHR

7400SM-6, 7400SM-7, 7400SM-8, 7400SM-9, 7400SM-10, 7400SM-11, 7400SM-12, 7400SM-13, 7400SM-14, 7400SM-15, 7400SM-16, 7400SM-17, 7400SM-18, 7400SM-19, 7400SM-20, 7400SM-21, 7400SM-22



7750RN



7760, 7762



7754



7766



3/8" Square Drive Socket Set with Imperial Bi-Hex Profile and Round Head Ratchet/Breaker Bar



A7535DZE



165 x 500 x 45 mm

1 A7535DZE

A7400DZ-1/2, A7400DZ-17/32, A7400DZ-1/4, A7400DZ-3/4, A7400DZ-13/16, A7400DZ-19/32, A7400DZ-11/16, A7400DZ-3/8, A7400DZ-7/16, A7400DZ-5/16, A7400DZ-7/8, A7400DZ-9/16, A7400DZ-5/8



7755-3/8



7754



7760, 7762



7766



7758



7752



3/8" Square Drive Socket Set on Rail with Metric Hex Profile



7400SR/



12

35 x 220 x 25 mm

1 7400SR/S12



7400SM-11, 7400SM-10, 7400SM-15, 7400SM-14, 7400SM-13, 7400SM-12, 7400SM-16, 7400SM-9, 7400SM-8, 7400SM-17, 7400SM-19, 7400SM-18



3/8" Square Drive Socket Set on Rail with Metric Bi-Hex Profile



7409MB



9

1 7409MB

A7400DM-7, A7400DM-8, A7400DM-10, A7400DM-11, A7400DM-13, A7400DM-15, A7400DM-17, A7400DM-19, A7400DM-22



3/8" Square Drive Deep Socket Set on Rail with Metric Bi-Hex Profile



7408MD



8

1 7408MD

A7402DM-10, A7402DM-11, A7402DM-12, A7402DM-13, A7402DM-14, A7402DM-16, A7402DM-17, A7402DM-19



3/8" Square Drive Socket Set for TORX® Head Screw



7400TORX-ER/



7

25 x 55 x 190 mm

1 7400TORX-ER/S7

7400TORX-E14, 7400TORX-E12, 7400TORX-E11, 7400TORX-E10, 7400TORX-E18, 7400TORX-E16, 7400TORX-E8



1/2" Square Drive Deep Socket Set with Metric Hex Profile



S1612L



49 x 152 x 280 mm

4 S1612L

1/2" socket set with Hex bits - 9 Pcs



S9HEX



46 x 130 x 195 mm

10 S9HEX

1/2" socket set with TORX® bits - 9 Pcs



S9TORX



46 x 130 x 195 mm

10 S9TORX

1/2" Socket Set with Hex Bits - 18 Pcs



S18HEX



100 x 210 x 370 mm

4 S18HEX

1/2" Socket Set with TORX® Bits - 18 Pcs



S18TORX



100 x 210 x 370 mm

4 S18TORX

1/2" Square Drive Socket Set with Metric Hex Profile and Ratchet



S240



100 x 215 x 375 mm

4 S240

SBS81

8166

8160-5, 8160-10

7772H

8158-10

7800SM-10, 7800SM-11, 7800SM-12, 7800SM-13, 7800SM-14, 7800SM-15, 7800SM-16, 7800SM-17, 7800SM-18, 7800SM-19, 7800SM-20, 7800SM-21, 7800SM-22, 7800SM-23, 7800SM-24, 7800SM-27, 7800SM-30, 7800SM-32



S240-BOX

1/2" Square Drive Socket Set with Metric Hex Profile and Combination Spanner Set



S400



110 x 320 x 375 mm

2 S400

7800SM-10, 7800SM-11, 7800SM-12, 7800SM-13, 7800SM-14, 7800SM-15, 7800SM-16, 7800SM-17, 7800SM-18, 7800SM-19, 7800SM-20, 7800SM-21, 7800SM-22, 7800SM-23, 7800SM-24, 7800SM-25, 7800SM-26, 7800SM-27, 7800SM-28, 7800SM-30, 7800SM-32

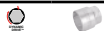

SBS81

8160-5, 8160-10

8166

7772H

8158-10

111M-7, 111M-8, 111M-9, 111M-10, 111M-11, 111M-12, 111M-13, 111M-14, 111M-15, 111M-16, 111M-17, 111M-18, 111M-19



1/2" Square Drive Socket Set with Imperial Hex Profile and Ratchet



S240AF



100 x 215 x 375 mm

4 S240AF

1/2" Sockets inches and Combination Spanners inches set - 35 Pcs



S350AF

110 x 371 x 313 mm 2 S350AF

S 3/8, S 9/16, S 1.1/4, S 1.1/16, S 1.3/16, S 15/16, S 1.1/8, S 1/2, S 1", S 5/8, S 7/8, S 3/4, S 7/16

- 815
- 703/A MP
- 763, 753
- 773

1/2" Square Drive Socket Driver Set for Metric Hex Head Screw



7809M/10

45 x 110 x 255 mm 1 7809M/10

7809M-5, 7809M-6, 7809M-7, 7809M-8, 7809M-9, 7809M-10, 7809M-12, 7809M-14, 7809M-17, 7809M-19

1/2" Square Drive Socket Driver Set for Imperial Hex Head Screw



7809Z/10

45 x 110 x 255 mm 1 7809Z/10

7809Z-3/8, 7809Z-5/16, 7809Z-7/16, 7809Z-1/4, 7809Z-19/32, 7809Z-5/8, 7809Z-17/32, 7809Z-9/16, 7809Z-1/2, 7809Z-3/16

1/2" Square Drive Socket Driver Set for TORX®/Phillips Head Screw



7809TORX/10

45 x 110 x 255 mm 1 7809TORX/10

7809TORX-T20, 7809TORX-T27, 7809TORX-T25, 7809TORX-T40, 7809TORX-T30, 7809TORX-T45, 7809TORX-T50, 7809TORX-T55

7809M-6, 7809M-8

1/2" Square Drive Socket Set with Metric Bi-Hex Profile and Slim Head Ratchet Metal Case



7814DS

60 x 185 x 445 mm 1 7814DS

7800DM-10, 7800DM-11, 7800DM-12, 7800DM-13, 7800DM-14, 7800DM-15, 7800DM-16, 7800DM-17, 7800DM-18, 7800DM-19

- 8150SL
- 8160-5, 8160-10
- 8166

1/2" Square Drive Socket Set with Metric Bi-Hex Profile and Sliding T-Handle Metal Case



7818DS

60 x 185 x 445 mm 1 7818DS

7800DM-8, 7800DM-10, 7800DM-11, 7800DM-12, 7800DM-13, 7800DM-14, 7800DM-15, 7800DM-16, 7800DM-17, 7800DM-18, 7800DM-19, 7800DM-21, 7800DM-22

- 8150SL
- 8160-5, 8160-10
- 8154-11
- 8166

1/2" Square Drive Socket Set with Metric Hex Profile and Round Head Ratchet



7818MHR

50 x 185 x 445 mm 1 7818MHR

7800SM-10, 7800SM-11, 7800SM-12, 7800SM-13, 7800SM-14, 7800SM-15, 7800SM-17, 7800SM-19, 7800SM-22, 7800SM-24, 7800SM-27, 7800SM-30, 7800SM-32

- 8150RN-1/2
- 8160-5, 8160-10
- 8154-11
- 8166



1/2" Square Drive Socket Set with Metric Hex Profile and Reversible Ratchet/Sliding T-Handle



7825MHP

60 x 185 x 445 mm 1 7825MHP

- 7800SM-10, 7800SM-11, 7800SM-12, 7800SM-13, 7800SM-14, 7800SM-15, 7800SM-16, 7800SM-17, 7800SM-18, 7800SM-19, 7800SM-20, 7800SM-21, 7800SM-22, 7800SM-23, 7800SM-24, 7800SM-26, 7800SM-27, 7800SM-28, 7800SM-30, 7800SM-32
- 8150-1/2
- 8160-5, 8160-10
- 8154-11
- 8166

1/2" Square Drive Socket Set with Metric Bi-Hex Profile and Reversible Ratchet/Universal Joint



7825MBP

60 x 185 x 445 mm 1 7825MBP

- 7800DM-10, 7800DM-11, 7800DM-12, 7800DM-13, 7800DM-14, 7800DM-15, 7800DM-16, 7800DM-17, 7800DM-18, 7800DM-19, 7800DM-20, 7800DM-21, 7800DM-22, 7800DM-23, 7800DM-24, 7800DM-26, 7800DM-27, 7800DM-28, 7800DM-30, 7800DM-32
- 8150-1/2
- 8160-5, 8160-10
- 8154-11
- 8166

1/2" Square Drive Socket Set with Metric Bi-Hex Profile and Round Head Ratchet



7819DRN

51 x 225 x 445 mm 1 7819DRN

- 7800DM-19, 7800DM-18, 7800DM-17, 7800DM-16, 7800DM-23, 7800DM-22, 7800DM-21, 7800DM-11, 7800DM-10, 7800DM-15, 7800DM-13, 7800DM-14, 7800DM-12, 7800DM-24, 7800DM-26, 7800DM-27, 7800DM-28, 7800DM-30, 7800DM-32
- 8150RN-1/2
- 8152-1/2
- 8166-1/2
- 8160-5, 8160-10
- 8154-11
- 8166

1/2" Square Drive Socket Set with Metric Bi-Hex Profile and Pear Head Ratchet/Extension Bars



7888DM

73 x 340 x 445 mm 1 7888DM

- 7800DM-10, 7800DM-11, 7800DM-12, 7800DM-13, 7800DM-14, 7800DM-15, 7800DM-16, 7800DM-17, 7800DM-18, 7800DM-19, 7800DM-20, 7800DM-21, 7800DM-22, 7800DM-23, 7800DM-24, 7800DM-26, 7800DM-27, 7800DM-28, 7800DM-30, 7800DM-32
- 8150-1/2
- 8154-11
- 8160-3, 8160-5, 8160-10
- 8166
- 8157-15

1/4" and 1/2" Square Drive Socket Set with Metric Hex Profile



7847SS

60 x 225 x 445 mm 1 7847SS





- 6700SM-5, 6700SM-6, 6700SM-7, 6700SM-8, 6700SM-9, 6700SM-10, 6700SM-11, 6700SM-12, 6700SM-13
- 6950SL
- 6960, 6962
- 6954
- 6966
- 6956
- 59S/PH1, 59S/PH2, 59S/PH3
- 59S/PZ1, 59S/PZ2, 59S/PZ3
- 59S/0.6-4.5, 59S/0.8-5.5, 59S/1.2-8.0
- 59S/H3, 59S/H4, 59S/H5, 59S/H6
- 7800SM-10, 7800SM-11, 7800SM-12, 7800SM-13, 7800SM-14, 7800SM-15, 7800SM-17, 7800SM-19, 7800SM-22, 7800SM-24, 7800SM-27, 7800SM-30, 7800SM-32
- 8150SL
- 6973A
- 8160-5, 8160-10
- 8154-11
- 8166

1/2" Square Drive Socket Set with Imperial Bi-Hex Profile and Slim Head Ratchet





7817DZS





60 x 185 x 445 mm 1 7817DZS

7800DZ-3/8, 7800DZ-7/16, 7800DZ-1/2, 7800DZ-9/16, 7800DZ-5/8, 7800DZ-11/16, 7800DZ-3/4, 7800DZ-13/16, 7800DZ-7/8, 7800DZ-15/16, 7800DZ-1, 7800DZ-1.1/8, 7800DZ-1.1/4		
8150SL		
8160-5, 8160-10		
8166		

1/2" Square Drive Socket Set with Imperial Bi-Hex Profile and Slim Head Ratchet - 13 Pcs 











7817DZS1			
60 x 185 x 445 mm	4500 g	1	7817DZS1

7800DZ-3/8, 7800DZ-7/16, 7800DZ-1/2, 7800DZ-9/16, 7800DZ-5/8, 7800DZ-11/16, 7800DZ-3/4, 7800DZ-13/16, 7800DZ-7/8, 7800DZ-15/16, 7800DZ-1, 7800DZ-1.1/8, 7800DZ-1.1/16		
8150SL		
8160-5, 8160-10		
8166		

1/2" Square Drive Socket Set with Imperial Bi-Hex Profile and Slim Head Ratchet/ Sliding T-Handle 









7823DZS		
60 x 185 x 445 mm	1	7823DZS

7800DZ-3/8, 7800DZ-7/16, 7800DZ-1/2, 7800DZ-9/16, 7800DZ-5/8, 7800DZ-11/16, 7800DZ-3/4, 7800DZ-13/16, 7800DZ-7/8, 7800DZ-15/16, 7800DZ-1, 7800DZ-1.1/8, 7800DZ-1.1/4, 7800DZ-1.5/16		
8150SL		
8160-5, 8160-10		
8154-11		
8166		

1/2" Square Drive Socket Set with Metric Bi-Hex Profile and Sliding T-Handle Polyester Textile Case 





7818DST		
60 x 220 x 480 mm	1	7818DST

7800DM-8, 7800DM-10, 7800DM-11, 7800DM-12, 7800DM-13, 7800DM-14, 7800DM-15, 7800DM-16, 7800DM-17, 7800DM-18, 7800DM-19, 7800DM-21, 7800DM-22		
8150SL		
8160-5, 8160-10		
8166		
8154-11		

1/2" Square Drive Socket Set with Metric Hex Profile and Slim Head Ratchet 







7818SST		
60 x 220 x 480 mm	1	7818SST

7800SM-10, 7800SM-11, 7800SM-12, 7800SM-13, 7800SM-14, 7800SM-15, 7800SM-16, 7800SM-17, 7800SM-18, 7800SM-19, 7800SM-20, 7800SM-21, 7800SM-22, 7800SM-23, 7800SM-24, 7800SM-26, 7800SM-27, 7800SM-30, 7800SM-32		
8150SL		
8160-1/2, 8162-1/2, 8166-1/2, 8154-1/2		

1/2" Square Drive Socket Set with Metric Hex Profile and Slim Head Ratchet/ Universal Joint 







7825SST		
65 x 250 x 480 mm	1	7825SST

7800SM-10, 7800SM-11, 7800SM-12, 7800SM-13, 7800SM-14, 7800SM-15, 7800SM-16, 7800SM-17, 7800SM-18, 7800SM-19, 7800SM-20, 7800SM-21, 7800SM-22, 7800SM-23, 7800SM-24, 7800SM-26, 7800SM-27, 7800SM-28, 7800SM-30, 7800SM-32		
8150SL		
8160-1/2, 8162-1/2, 8166-1/2, 8154-1/2		

1/2" Square Drive Socket Set with Metric Bi-Hex Profile and Slim Head Ratchet 



7825DST		
65 x 250 x 480 mm	1	7825DST

7800DM-10, 7800DM-11, 7800DM-12, 7800DM-13, 7800DM-14, 7800DM-15, 7800DM-16, 7800DM-17, 7800DM-18, 7800DM-19, 7800DM-20, 7800DM-21, 7800DM-22, 7800DM-23, 7800DM-24, 7800DM-26, 7800DM-27, 7800DM-28		
8150SL		
8160-1/2, 8162-1/2, 8166-1/2, 8154-1/2		



1/2" Square Drive Socket Set with Metric Bi-Hex Profile and Slim Head Ratchet/Breaker Bar



7827DST



65 x 250 x 480 mm

1 7827DST

7800DM-10, 7800DM-11, 7800DM-12, 7800DM-13, 7800DM-14, 7800DM-15, 7800DM-16, 7800DM-17, 7800DM-18, 7800DM-19, 7800DM-20, 7800DM-21, 7800DM-22, 7800DM-23, 7800DM-24, 7800DM-26, 7800DM-27, 7800DM-28, 7800DM-30, 7800DM-32

8150SL

8159-1/2, 8160-1/2, 8162-1/2, 8154-1/2, 8166-1/2, 8158-1/2

1/2" Square Drive Socket Set on Rail with Metric Hex Profile



7810MH



10

1 7810MH

7800SM-10, 7800SM-11, 7800SM-13, 7800SM-14, 7800SM-15, 7800SM-16, 7800SM-19, 7800SM-17, 7800SM-21, 7800SM-22

1/2" Square Drive Socket Set with Metric Bi-Hex Profile - 10 Pcs/Rail



7810MB



10

1 7810MB

7800DM-11, 7800DM-10, 7800DM-14, 7800DM-13, 7800DM-16, 7800DM-17, 7800DM-19, 7800DM-22, 7800DM-21, 7800DM-15

1/2" Square Drive Socket Set with Metric Bi-Hex Profile - 6 Pcs/Rail



7806MD



6

1 7806MD

7805DM-10, 7805DM-14, 7805DM-13, 7805DM-17, 7805DM-19, 7805DM-22

1/2" Square Drive Socket Set on Rail with TORX® Profile



7807TE



7

1 7807TE

7800TORX-E10, 7800TORX-E12, 7800TORX-E14, 7800TORX-E16, 7800TORX-E18, 7800TORX-E20, 7800TORX-E24

3/4" Square Drive Socket Set with Metric Hex Profile and Ratchet Head



SLX 17



375 x 430 x 110 mm

1 SLX 17

3/4" Square Drive Socket Set with Imperial Hex Profile and Ratchet Head - 17 Pcs



SLX17AF

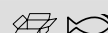

70 x 375 x 430 mm

1 SLX 17AF

3/4" Square Drive Socket Set with Metric Hex Profile and Round Ratchet Head/ Sliding T-Head



8845NM

94 x 206 x 591 mm	1	8845NM	
8900SM-24, 8900SM-22, 8900SM-27, 8900SM-30, 8900SM-32, 8900SM-36, 8900SM-38, 8900SM-41, 8900SM-46, 8900SM-50			
8953			
8954A			
8962, 8961			
8950N/A			

3/4" Square Drive Socket Set with Metric Bi-Hex Profile and Round Ratchet Head/ Sliding T-Head



8840M

94 x 206 x 591 mm	1	8845DM	
8900DM-19, 8900DM-22, 8900DM-24, 8900DM-25, 8900DM-27, 8900DM-28, 8900DM-30, 8900DM-32, 8900DM-36, 8900DM-41, 8900DM-46, 8900DM-50, 8900DM-55, 8900DM-60			
8953			
8950N/A			
8951			
8954A			
8958A			
8962, 8961			
8966			
8965			
8961, 8962			

3/4" Square Drive Socket Set with Metric Bi-Hex Profile and Round Ratchet Head



8821MB

95 x 220 x 600 mm	1	8821MB	
8950N/A			
8954			
8965			
8966			
8961, 8962			
8900DM-26, 8900DM-23, 8900DM-22, 8900DM-24, 8900DM-27, 8900DM-29, 8900DM-28, 8900DM-32, 8900DM-30, 8900DM-34, 8900DM-38, 8900DM-35, 8900DM-36, 8900DM-46, 8900DM-41, 8900DM-42, 8900DM-50			

3/4" Square Drive Socket Set with Metric Bi-Hex Profile - 24 Pcs



8840M

100 x 210 x 595 mm	1	8840M	
8900DM-19, 8900DM-22, 8900DM-24, 8900DM-25, 8900DM-27, 8900DM-28, 8900DM-30, 8900DM-32, 8900DM-36, 8900DM-41, 8900DM-46, 8900DM-50, 8900DM-55, 8900DM-60			
8953			
8950N/A			
8951			
8954A			
8958A			
8962, 8961			
8966			
8965			
8172			

1" Square Drive Socket Set with Metric Hex Profile and Round Head Ratchet



9540MB

210 x 560 x 120 mm	1	9540MB	
9500SM-80, 9500SM-75, 9500SM-70, 9500SM-65, 9500SM-60, 9500SM-55, 9500SM-50, 9500SM-46			
9550AB			
9555			
9560AB, 9563AB			

1" Square Drive Socket Set with Metric Hex Profile and Round Head Ratchet/ Adaptor



9540MBL

225 x 605 x 120 mm	1	9540MBL	
9500SM-80, 9500SM-77, 9500SM-71, 9500SM-70, 9500SM-67, 9500SM-65, 9500SM-63, 9500SM-60, 9500SM-75, 9500SM-46, 9500SM-50, 9500SM-54, 9500SM-55, 9500SM-58			
9550AB			
9560AB, 9563AB			
9555			



1" Socket Set with Imperial Bi-Hex Profile
- 11 Pcs



9540DZ

150 x 260 x 670 mm	1 9540DZ

9550AB	
9555	
9563AB, 9560AB	
9500DZ-2.3/4, 9500DZ-2.3/8, 9500DZ-2.3/16, 9500DZ-3, 9500DZ-1.13/16, 9500DZ-3.1/8, 9500DZ-2.5/8, 9500DZ-2	

1" Socket Set bihexagonal in inches. Metal case



9540DZL

140 x 285 x 630 mm	1 9540DZL

9500DZ-2.1/4, 9500DZ-2.3/4, 9500DZ-2.3/8, 9500DZ-2.1/2, 9500DZ-2.15/16, 9500DZ-2.1/8, 9500DZ-1.7/8, 9500DZ-2.3/16, 9500DZ-3, 9500DZ-1.13/16, 9500DZ-3.1/8, 9500DZ-2.5/8, 9500DZ-2, 9500DZ-2.9/16	
9550AB	
9555	
9563AB, 9560AB	
9565AB	

1/4"

1/4" Square Drive Sockets with Metric Hex Profile and High Polished Finish



6700SM

4 mm	5	6700SM-4
4.5 mm	5	6700SM-4.5
5 mm	5	6700SM-5
5.5 mm	5	6700SM-5.5
6 mm	5	6700SM-6
7 mm	5	6700SM-7
8 mm	5	6700SM-8
9 mm	5	6700SM-9
10 mm	5	6700SM-10
11 mm	5	6700SM-11
12 mm	5	6700SM-12
13 mm	5	6700SM-13
14 mm	5	6700SM-14
4 mm	1	SB6700SM-4
4.5 mm	1	SB6700SM-4.5
5 mm	1	SB6700SM-5
5.5 mm	1	SB6700SM-5.5
6 mm	1	SB6700SM-6
7 mm	1	SB6700SM-7
8 mm	1	SB6700SM-8
9 mm	1	SB6700SM-9
10 mm	1	SB6700SM-10
11 mm	1	SB6700SM-11
12 mm	1	SB6700SM-12
13 mm	1	SB6700SM-13
14 mm	1	SB6700SM-14

SB: Retail pack on a plastic info card

1/4" Square Drive Sockets with Imperial Hex Profile



6700SZ

1/8 in	5	6700SZ-1/8
5/32 in	5	6700SZ-5/32
3/16 in	5	6700SZ-3/16
7/32 in	5	6700SZ-7/32
1/4 in	5	6700SZ-1/4
9/32 in	5	6700SZ-9/32
5/16 in	5	6700SZ-5/16
11/32 in	5	6700SZ-11/32
3/8 in	5	6700SZ-3/8
7/16 in	5	6700SZ-7/16
1/2 in	5	6700SZ-1/2

9/16 in	5	6700SZ-9/16
1/8 in	5	SB6700SZ-1/8
5/32 in	1	SB6700SZ-5/32
3/16 in	1	SB6700SZ-3/16
7/32 in	1	SB6700SZ-7/32
1/4 in	1	SB6700SZ-1/4
9/32 in	1	SB6700SZ-9/32
5/16 in	1	SB6700SZ-5/16
11/32 in	1	SB6700SZ-11/32
3/8 in	1	SB6700SZ-3/8
7/16 in	1	SB6700SZ-7/16
1/2 in	1	SB6700SZ-1/2
9/16 in	1	SB6700SZ-9/16

SB: Retail pack on a plastic info card

1/4" Square Drive Sockets with TORX® Profile



6700TORX-E

E4	5	6700TORX-E4
E5	5	6700TORX-E5
E6	5	6700TORX-E6
E7	5	6700TORX-E7
E8	5	6700TORX-E8
E10	5	6700TORX-E10
E4	1	SB6700TORX-E4
E5	1	SB6700TORX-E5
E6	1	SB6700TORX-E6
E7	1	SB6700TORX-E7
E8	1	SB6700TORX-E8
E10	1	SB6700TORX-E10

SB: Retail pack on a plastic info card

1/4" Square Drive Sockets with Metric Square Profile for Refrigeration Ratchet



R6810M

3.4 mm	5	R6810M-3,4
4 mm	5	R6810M-4
4.5 mm	5	R6810M-4,5
5 mm	5	R6810M-5
6 mm	5	R6810M-6
7 mm	1	R6810M-7
8 mm	5	R6810M-8
9 mm	5	R6810M-9
10 mm	5	R6810M-10

1/4" Square Drive Sockets with Imperial Square Profile for Refrigeration Ratchet



R6810Z



3/16 in	1	R6810Z-3/16
7/32 in	1	R6810Z-7/32
1/4 in	1	R6810Z-1/4
5/16 in	1	R6810Z-5/16
3/8 in	1	R6810Z-3/8

1/4" Square Drive Plumbing Adaptor for Refrigeration Ratchet



R6822Z

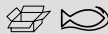

5 R6822Z

1/4" Square Drive Female to Female Adaptor



R6967



1/4 5 R6967

1/4" Square Drive Male to Male Adaptor



R6964A



1 R6964A

1/4" Square Drive Sockets with Metric Bi-Hex Profile



A6700DM



5 mm	5	A6700DM-5
5.5 mm	5	A6700DM-5.5
6 mm	5	A6700DM-6
7 mm	5	A6700DM-7
8 mm	5	A6700DM-8
9 mm	5	A6700DM-9
10 mm	5	A6700DM-10
11 mm	5	A6700DM-11
12 mm	5	A6700DM-12
13 mm	5	A6700DM-13
14 mm	5	A6700DM-14

5 mm	1	SBA6700DM-5
5.5 mm	1	SBA6700DM-5.5
6 mm	1	SBA6700DM-6
7 mm	1	SBA6700DM-7
8 mm	1	SBA6700DM-8
9 mm	1	SBA6700DM-9
10 mm	1	SBA6700DM-10
11 mm	1	SBA6700DM-11
12 mm	1	SBA6700DM-12
13 mm	1	SBA6700DM-13
14 mm	1	SBA6700DM-14

SB: Retail pack on a plastic info card

1/4" Square Drive Sockets with Imperial Bi-Hex Profile



A6700DZ



3/16 in	5	A6700DZ-3/16
7/32 in	5	A6700DZ-7/32
1/4 in	5	A6700DZ-1/4



9/32 in	5	A6700DZ-9/32
5/16 in	5	A6700DZ-5/16
11/32 in	5	A6700DZ-11/32
3/8 in	5	A6700DZ-3/8
7/16 in	5	A6700DZ-7/16
1/2 in	5	A6700DZ-1/2
9/16 in	5	A6700DZ-9/16
3/16 in	1	SBA6700DZ-3/16
7/32 in	1	SBA6700DZ-7/32
1/4 in	1	SBA6700DZ-1/4
9/32 in	1	SBA6700DZ-9/32
5/16 in	1	SBA6700DZ-5/16
11/32 in	1	SBA6700DZ-11/32
3/8 in	1	SBA6700DZ-3/8
7/16 in	1	SBA6700DZ-7/16
1/2 in	1	SBA6700DZ-1/2
9/16 in	1	SBA6700DZ-9/16

SB: Retail pack on a plastic info card

1/4" Square Drive Deep Sockets with Metric Bi-Hex Profile



A6800DM



4 mm	1	A6800DM-4
5 mm	1	A6800DM-5
5.5 mm	1	A6800DM-5.5
6 mm	1	A6800DM-6
7 mm	1	A6800DM-7
8 mm	1	A6800DM-8
9 mm	1	A6800DM-9
10 mm	1	A6800DM-10
11 mm	1	A6800DM-11
12 mm	1	A6800DM-12
13 mm	1	A6800DM-13
14 mm	1	A6800DM-14

4 mm	1	SBA6800DM-4
5 mm	1	SBA6800DM-5
5.5 mm	1	SBA6800DM-5.5
6 mm	1	SBA6800DM-6
7 mm	1	SBA6800DM-7
8 mm	1	SBA6800DM-8
9 mm	1	SBA6800DM-9
10 mm	1	SBA6800DM-10
11 mm	1	SBA6800DM-11
12 mm	1	SBA6800DM-12
13 mm	1	SBA6800DM-13
14 mm	1	SBA6800DM-14

SB: Retail pack on a plastic info card



1/4" Square Drive Deep Sockets with Metric Hex Profile



A6800SM

Size	Quantity	Part Number
4 mm	1	A6800SM-4
4.5 mm	1	A6800SM-4.5
5 mm	1	A6800SM-5
6 mm	1	A6800SM-6
7 mm	1	A6800SM-7
8 mm	1	A6800SM-8
9 mm	1	A6800SM-9
10 mm	1	A6800SM-10
11 mm	1	A6800SM-11
12 mm	1	A6800SM-12
13 mm	1	A6800SM-13
14 mm	1	A6800SM-14
15 mm	1	A6800SM-15

SB: Retail pack on a plastic info card

1/4" Square Drive Deep Sockets with Imperial Hex Profile



A6800SZ

Size	Quantity	Part Number
1/8 in	1	A6800SZ-1/8
5/32" in	1	A6800SZ-5/32

1/4" Square Drive Deep Sockets with Imperial Bi-Hex Profile



A6800DZ

Size	Quantity	Part Number
3/16 in	1	A6800DZ-3/16
7/32 in	1	A6800DZ-7/32
1/4 in	1	A6800DZ-1/4
9/32 in	1	A6800DZ-9/32
5/16 in	1	A6800DZ-5/16
11/32 in	1	A6800DZ-11/32
3/8 in	1	A6800DZ-3/8
7/16 in	1	A6800DZ-7/16

Size	Quantity	Part Number
1/2 in	1	A6800DZ-1/2
9/16 in	1	A6800DZ-9/16
3/16 in	1	SBA6800DZ-3/16
7/32 in	1	SBA6800DZ-7/32
1/4 in	1	SBA6800DZ-1/4
9/32 in	1	SBA6800DZ-9/32
5/16 in	1	SBA6800DZ-5/16
11/32 in	1	SBA6800DZ-11/32
3/8 in	1	SBA6800DZ-3/8
7/16 in	1	SBA6800DZ-7/16
1/2 in	1	SBA6800DZ-1/2
9/16 in	1	SBA6800DZ-9/16

SB: Retail pack on a plastic info card

1/4" Square Drive Swivel Sockets with Metric Bi-Hex Profile



A6710DM

Size	Quantity	Part Number
5.5 mm	1	A6710DM-5.5
6 mm	1	A6710DM-6
7 mm	1	A6710DM-7
8 mm	1	A6710DM-8
9 mm	1	A6710DM-9
10 mm	1	A6710DM-10
11 mm	1	A6710DM-11
12 mm	1	A6710DM-12
13 mm	1	A6710DM-13
14 mm	1	A6710DM-14

1/4" Square Drive Swivel Sockets with Imperial Bi-Hex Profile



A6710DZ

Size	Quantity	Part Number
3/16 in	1	A6710DZ-3/16
7/32 in	1	A6710DZ-7/32
1/4 in	1	A6710DZ-1/4
9/32 in	1	A6710DZ-9/32
5/16 in	1	A6710DZ-5/16
11/32 in	1	A6710DZ-11/32
3/8 in	1	A6710DZ-3/8
7/16 in	1	A6710DZ-7/16
1/2 in	1	A6710DZ-1/2
9/16 in	1	A6710DZ-9/16

1/4" Square Drive Breaker Bars with Swivel Head



6958

Length	Quantity	Part Number
153 mm	1	6958-6
153 mm	1	SB6958-6

SB: Retail pack on a plastic info card

1/4" Square Drive Sliding T-Handles



6954

Length	Quantity	Part Number
125 mm	1	6954
125 mm	10	SB6954-5

SB: Retail pack on a plastic info card

1/4" Square Drive Spinner Handles



6956

Length	Quantity	Part Number
150 mm	10	6956
150 mm	1	SB6956

SB: Retail pack on a plastic info card

1/4" Square Drive Extension Bars



6960 - 6962L

Length	Quantity	Part Number
26 mm	1	696EX-01
50 mm	1	6960
75 mm	10	6960-3
101 mm	1	6961
152 mm	1	6962
152 mm	1	696EX-06
200 mm	1	696EX-08
276 mm	1	696EX-11
355 mm	1	6962L
53 mm	1	SB6960
75 mm	1	SB6960-3
101 mm	1	SB6961
152 mm	1	SB6962
355 mm	1	SB6962L

1/4" Square Drive Universal Joints



6966

Length	Quantity	Part Number
35 mm	10	6966
35 mm	1	SB6966

SB: Retail pack on a plastic info card

1/4" Square Drive to 1/4" Hex Bit Adaptors



6709HL

Length	Quantity	Part Number
1/4 in	1	6709HL

1/4" Square Drive Wobbler Extension Bars



6960-W - 6962-W

Length	Quantity	Part Number
50 mm	10	6960W-2
100 mm	1	6960W-4
150 mm	10	6960W-6

1/4" Square Drive Universal Joints for Smooth Operations



6968

Length	Quantity	Part Number
35 mm	1	6968

1/4" Square Drive Adaptors for Hex Screwdriver Bit



6972H

Length	Quantity	Part Number
1/4" in	1	6972H
1/4"	5	

1/4" Square Drive Flexible Extension Bars



6963

Length	Quantity	Part Number
148 mm	1	SB6963
150 mm	20	6960F-6

1/4" Square Drive to 3/8" Socket Increasing Adaptors



7765

Input Size	Output Size	Quantity	Part Number
1/4"	3/8"	1	7765
1/4"	3/8"	1	SB7765

1/4" Square Drive Magnetic Adaptors for 1/4" Hex Screwdriver Bit



6973M

Length	Quantity	Part Number
1/4"	1	6973M



1/4" Square Drive Adaptors for 1/4" Hex Screwdriver Bit



6973A

1/4 in	10	6973A
1/4 in	1	SB6973A

SB: retail packed on a plastic info card

1/4" Square Drive to 1/4" Socket Flat Adaptors



6969

1/4	1	6969

1/4" Square Drive to 3/8" Socket Increasing Flat Adaptors



7767

1/4	1	7767
1/4	1	SB7767

SB: Retail pack on a plastic info card

1/4" Square Drive Increasing Flat Adaptor Set



8967/S3

110 x 194 x 30 mm	1 8967/S3

7767	
8167	
8967	

Socket Rails for 1/4" 3/8" and 1/2" Clips



RAIL-187/264/340

203 mm	10	RAIL-8
250 mm	10	RAIL-10
340 mm	3	RAIL-340

Rail-Clips for 1/4" Sockets/Socket Drivers



C1/4

17 mm	25	CLIPS-1/4

1/4" Square Drive Socket Drivers for Slotted Head Screw



6709F

0.6 mm	4.5 mm	5	6709F-4.5
0.8 mm	5.5 mm	5	6709F-5.5
0.9 mm	6.5 mm	5	6709F-6.5
1.2 mm	8 mm	5	6709F-8
0.6 mm	4.5 mm	1	SB6709F-4.5
0.8 mm	5.5 mm	1	SB6709F-5.5
0.9 mm	6.5 mm	1	SB6709F-6.5
1.2 mm	8 mm	1	SB6709F-8

SB: Retail pack on a plastic info card

1/4" Square Drive Socket Drivers for Philips Head Screw



6709PH

1	5	6709PH-1
2	5	6709PH-2
3	5	6709PH-3
1	1	SB6709PH-1
2	1	SB6709PH-2
3	1	SB6709PH-3

SB: Retail pack on a plastic info card

1/4" Square Drive Socket Drivers for Pozidriv Head Screw



6709PZ

1	5	6709PZ-1
2	5	6709PZ-2
3	5	6709PZ-3

1	1	SB6709PZ-1
2	1	SB6709PZ-2
3	1	SB6709PZ-3

SB: Retail pack on a plastic info card

1/4" Square Drive Socket Drivers for TORX® Head Screw



6709TORX		
T6	5	6709TORX-T6
T7	5	6709TORX-T7
T8	5	6709TORX-T8
T9	5	6709TORX-T9
T10	5	6709TORX-T10
T15	5	6709TORX-T15
T20	5	6709TORX-T20
T25	5	6709TORX-T25
T27	5	6709TORX-T27
T30	5	6709TORX-T30
T40	5	6709TORX-T40
T8	1	SB6709TORX-T8
T9	1	SB6709TORX-T9
T10	1	SB6709TORX-T10
T15	1	SB6709TORX-T15
T20	1	SB6709TORX-T20
T25	1	SB6709TORX-T25
T27	1	SB6709TORX-T27
T30	1	SB6709TORX-T30
T40	1	SB6709TORX-T40

SB: Retail pack on a plastic info card

1/4" Square Drive Socket Drivers for TORX® Tamper-Resistant Head Screw



6709TORX-R		
TR 8	1	6709TORX-R-T8
TR 10	1	6709TORX-R-T10
TR 15	1	6709TORX-R-T15
TR 20	1	6709TORX-R-T20
TR 25	1	6709TORX-R-T25
TR 8	1	SB6709TORX-R-T8
TR 10	1	SB6709TORX-R-T10

TR 15	1	SB6709TORX-R-T15
TR 20	1	SB6709TORX-R-T20
TR 25	1	SB6709TORX-R-T25

SB: Retail pack on a plastic info card

1/4" Square Drive Socket Drivers for TORX® PLUS® Head Screw



6709-IP		
IP6		1 6709-IP6
IP7		1 6709-IP7
IP8		1 6709-IP8
IP9		1 6709-IP9
IP10	M3	1 6709-IP10
IP15	-	1 6709-IP15
IP20	M4	1 6709-IP20
IP25	M5	1 6709-IP25
IP27	-	1 6709-IP27
IP30	M6	1 6709-IP30
IP40	M8	1 6709-IP40
IP45	-	1 6709-IP45

SB: Retail pack

1/4" Square Drive Socket Drivers for Hex Head Screw



6709M		
3 mm	5	6709M-3
4 mm	5	6709M-4
5 mm	5	6709M-5
6 mm	5	6709M-6
8 mm	5	6709M-8
10 mm	5	6709M-10
3 mm	1	SBS67M-3
4 mm	1	SB6709M-4
5 mm	1	SB6709M-5
6 mm	1	SB6709M-6
8 mm	1	SB6709M-8

SB: Retail pack on a plastic info card

1/4" Square Drive Deep Socket Drivers for Metric Hex Head Screw



A6709M		
2.5 mm	1	A6709M-2.5
3 mm	1	A6709M-3
4 mm	1	A6709M-4
5 mm	1	A6709M-5
6 mm	1	A6709M-6
2.5 mm	1	SBA6709M-2.5
3 mm	1	SBA6709M-3
4 mm	1	SBA6709M-4
5 mm	1	SBA6709M-5
6 mm	1	SBA6709M-6

SB: Retail pack on a plastic info card

1/4" Square Drive Deep Socket Drivers for Imperial Hex Head Screw



A6709Z		
1/8 in	1	A6709Z-1/8
9/64 in	1	A6709Z-9/64
5/32 in	1	A6709Z-5/32
3/16 in	1	A6709Z-3/16
1/8 in	1	SBA6709Z-1/8
9/64 in	1	SBA6709Z-9/64
5/32 in	1	SBA6709Z-5/32
3/16 in	1	SBA6709Z-3/16

SB: Retail pack on a plastic info card



1/4" Slim Head Reversible Ratchets with 72 Teeth and 5° Action Angle



6950SL

119 mm	72	1	6950SL

1/4" Refrigeration Reversible Ratchets with 32 Teeth and 11.5° Action Angle



R6950

160 mm	32	1	R6950

1/4" Swivel Head Ratchets with 72 Teeth and 5° Action Angle



8120-1/4

149 mm	72	20	8120-1/4

1/4" Pear Head Reversible Ratchets with 72 Teeth and 5° Action Angle



6950

121 mm	72	1	6950
121 mm	72	1	SB6950

1/4" Pear Head Reversible Ratchets with 60 Teeth and 6° Action Angle



SBS61

145 mm	60	1	SBS61

SB: Retail pack

Combination Ratcheting Wrenches for Screwdriver Bits



2058-BR

52	1	2058-BR

1/4" Round Head Reversible Ratchets with 72 Teeth and 5° Action Angle



6950RN

121 mm	72	1	6950RN
121 mm	72	1	SB6950RN

1/4" Pear Head Short Reversible Ratchets with 60 Teeth and 6° Action Angle



SBS61S

120 mm	60	1	SBS61S

SB: Retail pack

Ratcheting Adaptors with 52 Teeth for 1/4" Ratchet



6951

40 mm	1	6951

Spare Part Kit for 6950SL 1/4" Ratchet



6950SL-SPARE

10	6950SL	1 6950SL-SPARE

1/4" Spare Part Kit for 6950 Ratchet



6950-SPARE

12	6950	1 6950-SPARE

Spare Part Kit for 6950RN 1/4" Ratchet



6950RN-SPARE

6	6950RN	1 6950RN-SPARE

3/8"

3/8" Square Drive Sockets with Metric Hex Profile and High Polished Finish



7400SM

6 mm	5 7400SM-6
7 mm	5 7400SM-7
8 mm	5 7400SM-8
9 mm	5 7400SM-9
10 mm	5 7400SM-10
11 mm	5 7400SM-11
12 mm	5 7400SM-12
13 mm	5 7400SM-13
14 mm	5 7400SM-14
15 mm	5 7400SM-15
16 mm	5 7400SM-16
17 mm	5 7400SM-17
18 mm	5 7400SM-18
19 mm	5 7400SM-19
20 mm	5 7400SM-20
21 mm	5 7400SM-21
22 mm	5 7400SM-22

6 mm	1 SB7400SM-6
7 mm	1 SB7400SM-7
8 mm	1 SB7400SM-8
9 mm	1 SB7400SM-9
10 mm	1 SB7400SM-10
11 mm	1 SB7400SM-11
12 mm	1 SB7400SM-12
13 mm	1 SB7400SM-13
14 mm	1 SB7400SM-14
15 mm	1 SB7400SM-15
16 mm	1 SB7400SM-16
17 mm	1 SB7400SM-17
18 mm	1 SB7400SM-18
19 mm	1 SB7400SM-19
20 mm	1 SB7400SM-20
21 mm	1 SB7400SM-21
22 mm	1 SB7400SM-22

SB: Retail pack on a plastic info card

3/8" Square Drive Sockets with Metric Bi-Hex Profile



A7400DM

6 mm	5 A7400DM-6
7 mm	5 A7400DM-7
8 mm	5 A7400DM-8

9 mm	5 A7400DM-9
10 mm	5 A7400DM-10
11 mm	5 A7400DM-11
12 mm	5 A7400DM-12
13 mm	5 A7400DM-13
14 mm	5 A7400DM-14
15 mm	5 A7400DM-15
16 mm	5 A7400DM-16
17 mm	5 A7400DM-17
18 mm	5 A7400DM-18
19 mm	5 A7400DM-19
20 mm	5 A7400DM-20
21 mm	5 A7400DM-21
22 mm	5 A7400DM-22
24 mm	5 A7400DM-24
6 mm	1 SBA7400DM-6
7 mm	1 SBA7400DM-7
8 mm	1 SBA7400DM-8
9 mm	1 SBA7400DM-9
10 mm	1 SBA7400DM-10
11 mm	1 SBA7400DM-11
12 mm	1 SBA7400DM-12
13 mm	1 SBA7400DM-13
14 mm	1 SBA7400DM-14
15 mm	1 SBA7400DM-15
16 mm	1 SBA7400DM-16
17 mm	1 SBA7400DM-17
18 mm	1 SBA7400DM-18
19 mm	1 SBA7400DM-19
20 mm	1 SBA7400DM-20
21 mm	1 SBA7400DM-21
22 mm	1 SBA7400DM-22

SB: Retail pack on a plastic info card

3/8" Square Drive Sockets with Imperial Hex Profile



7400SZ

1/4" in	1 7400SZ-1/4
5/16" in	1 7400SZ-5/16
11/32" in	1 7400SZ-11/32
3/8" in	1 7400SZ-3/8
7/16" in	1 7400SZ-7/16
1/2" in	1 7400SZ-1/2
9/16" in	1 7400SZ-9/16
5/8" in	1 7400SZ-5/8
11/16" in	1 7400SZ-11/16
3/4" in	1 7400SZ-3/4
13/16" in	1 7400SZ-13/16
7/8" in	1 7400SZ-7/8



3/8" Square Drive Sockets with Imperial Bi-Hex Profile



A7400DZ

A7400DZ	
1/4 in	5 A7400DZ-1/4
5/16 in	5 A7400DZ-5/16
3/8 in	5 A7400DZ-3/8
7/16 in	5 A7400DZ-7/16
1/2 in	5 A7400DZ-1/2
17/32 in	5 A7400DZ-17/32
9/16 in	5 A7400DZ-9/16
19/32 in	5 A7400DZ-19/32
5/8 in	5 A7400DZ-5/8
11/16 in	5 A7400DZ-11/16
3/4 in	5 A7400DZ-3/4
13/16 in	5 A7400DZ-13/16
7/8 in	5 A7400DZ-7/8
<hr/>	
1/4 in	1 SBA7400DZ-1/4
5/16 in	1 SBA7400DZ-5/16
3/8 in	1 SBA7400DZ-3/8
7/16 in	1 SBA7400DZ-7/16
1/2 in	1 SBA7400DZ-1/2
17/32 in	1 SBA7400DZ-17/32
9/16 in	1 SBA7400DZ-9/16
19/32 in	1 SBA7400DZ-19/32
5/8 in	1 SBA7400DZ-5/8
11/16 in	1 SBA7400DZ-11/16
3/4 in	1 SBA7400DZ-3/4
13/16 in	1 SBA7400DZ-13/16
7/8 in	1 SBA7400DZ-7/8

SB: Retail pack on a plastic info card

3/8" Square Drive Deep Sockets with Metric Bi-Hex Profile



A7402DM

A7402DM	
7 mm	1 A7402DM-7
8 mm	1 A7402DM-8
9 mm	1 A7402DM-9
10 mm	5 A7402DM-10
11 mm	1 A7402DM-11
12 mm	1 A7402DM-12
13 mm	1 A7402DM-13
14 mm	1 A7402DM-14
15 mm	1 A7402DM-15
16 mm	1 A7402DM-16
17 mm	1 A7402DM-17
18 mm	1 A7402DM-18
19 mm	1 A7402DM-19
21 mm	1 A7402DM-21
<hr/>	
7 mm	1 SBA7402DM-7
8 mm	1 SBA7402DM-8
9 mm	1 SBA7402DM-9
10 mm	1 SBA7402DM-10
11 mm	1 SBA7402DM-11
12 mm	1 SBA7402DM-12
13 mm	1 SBA7402DM-13
14 mm	1 SBA7402DM-14
15 mm	1 SBA7402DM-15
16 mm	1 SBA7402DM-16
17 mm	1 SBA7402DM-17
18 mm	1 SBA7402DM-18
19 mm	1 SBA7402DM-19

SB: Retail pack on a plastic info card

3/8" Square Drive Swivel Sockets with Imperial Bi-Hex Profile



A7410DZ

A7410DZ	
5/16 in	1 A7410DZ-5/16
3/8 in	1 A7410DZ-3/8
7/16 in	1 A7410DZ-7/16
1/2 in	1 A7410DZ-1/2
9/16 in	1 A7410DZ-9/16
5/8 in	1 A7410DZ-5/8
11/16 in	1 A7410DZ-11/16
3/4 in	1 A7410DZ-3/4

3/8" Square Drive Deep Sockets with Imperial Bi-Hex Profile



A7402DZ

A7402DZ	
1/4 in	1 A7402DZ-1/4
5/16 in	1 A7402DZ-5/16
3/8 in	1 A7402DZ-3/8
7/16 in	1 A7402DZ-7/16
1/2 in	1 A7402DZ-1/2
9/16 in	1 A7402DZ-9/16
19/32 in	1 A7402DZ-19/32
5/8 in	1 A7402DZ-5/8
11/16 in	1 A7402DZ-11/16
3/4 in	1 A7402DZ-3/4
13/16 in	1 A7402DZ-13/16

A7402DZ	
7/8 in	1 A7402DZ-7/8
1/4 in	1 SBA7402DZ-1/4
5/16 in	1 SBA7402DZ-5/16
3/8 in	1 SBA7402DZ-3/8
7/16 in	1 SBA7402DZ-7/16
1/2 in	1 SBA7402DZ-1/2
9/16 in	1 SBA7402DZ-9/16
19/32 in	1 SBA7402DZ-19/32
5/8 in	1 SBA7402DZ-5/8
11/16 in	1 SBA7402DZ-11/16
3/4 in	1 SBA7402DZ-3/4
13/16 in	1 SBA7402DZ-13/16
7/8 in	1 SBA7402DZ-7/8

SB: Retail pack on a plastic info card

3/8" Square Drive Sockets with TORX® Profile



7400TORX-E

7400TORX-E	
E8	5 7400TORX-E8
E10	5 7400TORX-E10
E11	5 7400TORX-E11
E12	5 7400TORX-E12
E14	5 7400TORX-E14
E16	5 7400TORX-E16
E18	5 7400TORX-E18
<hr/>	
E8	1 SB7400TORX-E8
E10	1 SB7400TORX-E10
E11	1 SB7400TORX-E11
E12	1 SB7400TORX-E12
E14	1 SB7400TORX-E14
E16	1 SB7400TORX-E16
E18	1 SB7400TORX-E18

SB: Retail pack on a plastic info card

3/8" Square Drive Speeders with Rotary Steel Handle



7752

7752	
435 mm	1 7752

3/8" Square Drive Swivel Head Breaker Bars



7758

Length (L)	Quantity	Part Number
250 mm	1	7758-10
250 mm	1	SB7758-10

SB: Retail pack on a plastic info card

3/8" Square Drive Extension Bars



7760-7761-7762

Length (L)	Quantity	Part Number
75 mm	1	7760
127 mm	1	7761
250 mm	1	7762
75 mm	1	SB7760
127 mm	1	SB7761
252 mm	1	SB7762

3/8" Square Drive Flexible Extension Bars

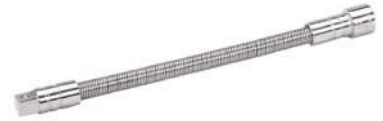

7759

Length (L)	Quantity	Part Number
200 mm	1	7759
200 mm	1	SB7759

3/8" Square Drive Sliding T-Handles



7754

Length (L)	Quantity	Part Number
160 mm	1	7754
160 mm	1	SB7754

SB: Retail pack on a plastic info card

3/8" Square Drive Wobbler Extension Bars



7760-W - 7761-W

Length (L)	Quantity	Part Number
75 mm	10	7760W-3
150 mm	10	7760W-6

3/8" Square Drive Universal Joints



7766

Length (L)	Quantity	Part Number
51.5 mm	1	7766
51.5 mm	1	SB7766

SB: Retail pack on a plastic info card

3/8" Square Drive Spinner Handles



7756

Length (L)	Quantity	Part Number
150 mm	6	7756
150 mm	1	SB7756

SB: With hanging clip

3/8" Square Drive Knurled Extension Bars



776EX

Length (L)	Quantity	Part Number
26 mm	1	776EX-01
76 mm	1	776EX-03
101 mm	1	776EX-04
150 mm	1	776EX-06
200 mm	1	776EX-08
275 mm	1	776EX-11

3/8" Square Drive Universal Joints for Smooth Operations



7768

Length (L)	Quantity	Part Number
45 mm	1	7768



3/8" Square Drive to 1/4" Socket
Decreasing Adaptors



7764

3/8	1/4		1 7764
3/8	1/4		1 SB7764

3/8" Square Drive Adaptors for 1/4" Hex
Screwdriver Bits



SBS780

1/4 in		20 7773A
1/4 in		1 SB7773A

3/8" Slim Head Reversible Ratchets with
72 Teeth and 5° Action Angle



7750SL

204 mm	72		1 7750SL
--------	----	--	----------

3/8" Square Drive to 1/2" Socket
Increasing Adaptors



8164-1/2

3/8"	1/2"		1 8164-1/2
------	------	--	------------

3/8" Square Drive Adaptors for 5/16" Hex
Screwdriver Bit



7106J

5/16 in		1 7106J
---------	--	---------

3/8" Pear Head Reversible Ratchets with
80 Teeth and 4.5° Action Angle



7750

207 mm	80		1 7750
207 mm	80		1 SB7750

3/8" Square Drive to 1/2" Socket
Increasing Flat Adaptors



8167

3/8	1/2		1 8167
-----	-----	--	--------

Rail-Clips for 3/8" Sockets/Socket Drivers



C3/8

19 mm		25 CLIPS-3/8
-------	--	--------------

3/8" Round Head Reversible Ratchets with
72 Teeth and 5° Action Angle



7750RN

206 mm	72		1 7750RN
206 mm	72		1 SB7750RN

3/8" Pear Head Reversible Ratchets with 60 Teeth and 6° Action Angle



SBS750

200 mm	60	10	SBS750

SB: Retail pack

3/8" Swivel Head Ratchets with 72 Teeth and 5° Action Angle



8120-3/8

223 mm	72	10	8120-3/8

3/8" Flex Head Reversible Ratchets with 60 Teeth and 6° Action Angle



7710

278 mm	60	1	7710

3/8" Square Drive Socket Drivers for Slotted Head Screw



7409F

6.4 mm	5	7409F-6.5
7.9 mm	5	7409F-8
9.5 mm	5	7409F-10
6.4 mm	1	SB7409F-6.5
7.9 mm	1	SB7409F-8
9.5 mm	1	SB7409F-10

SB: Retail pack on a plastic info card

3/8" Square Drive Socket Drivers for Philips Head Screw



7409PH

1	5	7409PH-1
2	5	7409PH-2
3	5	7409PH-3
1	1	SB7409PH-1
2	1	SB7409PH-2
3	1	SB7409PH-3

SB: Retail pack on a plastic info card

3/8" Square Drive Socket Drivers for TORX® Head Screw



7409TORX

T20	5	7409TORX-T20
T25	5	7409TORX-T25
T27	5	7409TORX-T27

T30	5	7409TORX-T30
T40	5	7409TORX-T40
T45	5	7409TORX-T45
T50	5	7409TORX-T50
T20	1	SB7409TORX-T20
T25	1	SB7409TORX-T25
T27	1	SB7409TORX-T27
T30	1	SB7409TORX-T30
T40	1	SB7409TORX-T40
T45	1	SB7409TORX-T45
T50	1	SB7409TORX-T50

SB: Retail pack on a plastic info card

3/8" Square Drive Socket Drivers for TORX® Tamper-Resistant Head Screw



7409TORX-R

TR 27	5	7409TORX-R-T27
TR 30	5	7409TORX-R-T30
TR 40	5	7409TORX-R-T40
TR 45	5	7409TORX-R-T45
TR 50	5	7409TORX-R-T50
TR 27	1	SB7409TORX-R-T27
TR 30	1	SB7409TORX-R-T30
TR 40	1	SB7409TORX-R-T40
TR 45	1	SB7409TORX-R-T45
TR 50	1	SB7409TORX-R-T50

SB: Retail pack on a plastic info card

3/8" Square Drive Socket Driver Set for TORX® Tamper-Resistant Head Screw



7409TORX-TRR/

5	25 x 55 x 190 mm	1	7409TORX-TRR/S5

7409TORX-R-T40, 7409TORX-R-T30, 7409TORX-R-T27, 7409TORX-R-T50, 7409TORX-R-T45



3/8" Square Drive Deep Socket Drivers for TORX® Head Screw



7409TORX-L

T25	5	7409TORX-T25-L
T30	5	7409TORX-T30-L
T40	5	7409TORX-T40-L
T45	5	7409TORX-T45-L
T50	5	7409TORX-T50-L
T25	1	SB7409TORX-T25-L
T30	1	SB7409TORX-T30-L
T40	1	SB7409TORX-T40-L
T45	1	SB7409TORX-T45-L
T50	1	SB7409TORX-T50-L

SB: Retail pack on a plastic info card

3/8" Square Drive Socket Drivers for Hex Head Screw



7409M

3 mm	5	7409M-3
4 mm	5	7409M-4
5 mm	5	7409M-5
6 mm	5	7409M-6
7 mm	5	7409M-7
8 mm	5	7409M-8
10 mm	5	7409M-10
3 mm	1	SB7409M-3
4 mm	1	SB7409M-4
5 mm	1	SB7409M-5
6 mm	1	SB7409M-6
7 mm	1	SB7409M-7
8 mm	1	SB7409M-8
10 mm	1	SB7409M-10

SB: Retail pack on a plastic info card

3/8" Square Drive Ball Socket Drivers for Hex Head Screw



7409BH

4 mm	5	7409BH-4
5 mm	1	7409BH-5
6 mm	5	7409BH-6

8 mm	5	7409BH-8
10 mm	5	7409BH-10
4 mm	1	SB7409BH-4
5 mm	1	SB7409BH-5
6 mm	1	SB7409BH-6
8 mm	1	SB7409BH-8
10 mm	1	SB7409BH-10

SB: Retail pack on a plastic info card

19 mm Pass Through Sockets with Metric Spline Profile



SBS19-TH

10 mm	1	SBS19-TH10
11 mm	1	SBS19-TH11
12 mm	1	SBS19-TH12
13 mm	1	SBS19-TH13
14 mm	1	SBS19-TH14
15 mm	1	SBS19-TH15
16 mm	1	SBS19-TH16
17 mm	1	SBS19-TH17
18 mm	1	SBS19-TH18
19 mm	1	SBS19-TH19
21 mm	1	SBS19-TH21
22 mm	1	SBS19-TH22
24 mm	1	SBS19-TH24

SB: Retail pack

3/8" Square Drive Socket Drivers for Hex Head Screws



7409Z

1/8 in	47 mm	1	7409Z-1/8
5/32 in	47 mm	1	7409Z-5/32
3/16 in	47 mm	1	7409Z-3/16
7/32 in	47 mm	1	7409Z-7/32
1/4 in	47 mm	1	7409Z-1/4
3/8 in	50.5 mm	1	7409Z-3/8

19 mm Pass Through 75 mm extension



SBS19-TH75

75 mm	1	SBS19-TH75
-------	---	------------

3/8" Square Drive Socket Driver Set on Rail for Hex Head Screw



7409MR/

7	25 x 55 x 190 mm	1	7409MR/S7
---	------------------	---	-----------

7409M-3, 7409M-4, 7409M-10, 7409M-8, 7409M-7, 7409M-6, 7409M-5

Ratcheting Adaptors with 52 Teeth for 3/8" Ratchet



7751

55 mm	175 g	10	7751
-------	-------	----	------

Spare Part Kit for 7750SL 3/8" Ratchet



7750SL-SPARE

12	7750SL	1	7750SL-SPARE
----	--------	---	--------------

Spare Part Kit for 7750 3/8" Ratchet



7750-SPARE

11	7750	1	7750-SPARE

Spare Part Kit for 7750RN 3/8" Ratchet



7750RN-SPARE

6	7750RN	1	7750RN-SPARE

1/2"

1/2" Square Drive Sockets with Metric Hex Profile and High Polished Finish



7800SM

8 mm	10	7800SM-8
9 mm	10	7800SM-9
10 mm	10	7800SM-10
11 mm	10	7800SM-11
12 mm	10	7800SM-12
13 mm	10	7800SM-13
14 mm	10	7800SM-14
15 mm	10	7800SM-15

16 mm	10	7800SM-16
17 mm	10	7800SM-17
18 mm	10	7800SM-18
19 mm	10	7800SM-19
20 mm	10	7800SM-20
21 mm	10	7800SM-21
22 mm	10	7800SM-22
23 mm	10	7800SM-23
24 mm	10	7800SM-24
25 mm	10	7800SM-25
26 mm	10	7800SM-26
27 mm	10	7800SM-27
28 mm	10	7800SM-28
29 mm	10	7800SM-29
30 mm	10	7800SM-30
32 mm	10	7800SM-32
33 mm	10	7800SM-33
34 mm	10	7800SM-34
36 mm	10	7800SM-36
8 mm	1	SB7800SM-8
9 mm	1	SB7800SM-9
10 mm	1	SB7800SM-10
11 mm	1	SB7800SM-11
12 mm	1	SB7800SM-12
13 mm	1	SB7800SM-13
14 mm	1	SB7800SM-14
15 mm	1	SB7800SM-15
16 mm	1	SB7800SM-16
17 mm	1	SB7800SM-17
18 mm	1	SB7800SM-18
19 mm	1	SB7800SM-19
21 mm	1	SB7800SM-20
21 mm	1	SB7800SM-21
22 mm	1	SB7800SM-22
23 mm	1	SB7800SM-23
24 mm	1	SB7800SM-24
25 mm	1	SB7800SM-25
26 mm	1	SB7800SM-26
27 mm	1	SB7800SM-27
28 mm	1	SB7800SM-28
29 mm	1	SB7800SM-29
30 mm	1	SB7800SM-30
32 mm	1	SB7800SM-32
33 mm	1	SB7800SM-33
34 mm	1	SB7800SM-34
36 mm	1	SB7800SM-36

SB: Retail pack on a plastic info card

1/2" Square Drive Deep Sockets with Metric Hex Profile



7805SM

10 mm	10	7805SM-10
11 mm	10	7805SM-11
12 mm	10	7805SM-12
13 mm	10	7805SM-13
14 mm	10	7805SM-14

15 mm	10	7805SM-15
16 mm	10	7805SM-16
17 mm	10	7805SM-17
18 mm	10	7805SM-18
19 mm	10	7805SM-19
20 mm	10	7805SM-20
21 mm	10	7805SM-21
22 mm	10	7805SM-22
23 mm	10	7805SM-23
24 mm	10	7805SM-24
25 mm	10	7805SM-25
26 mm	10	7805SM-26
27 mm	10	7805SM-27
28 mm	10	7805SM-28
29 mm	10	7805SM-29
30 mm	10	7805SM-30
32 mm	10	7805SM-32
34 mm	10	7805SM-34
10 mm	1	SB7805SM-10
11 mm	1	SB7805SM-11
12 mm	1	SB7805SM-12
13 mm	1	SB7805SM-13
14 mm	1	SB7805SM-14
15 mm	1	SB7805SM-15
16 mm	1	SB7805SM-16
17 mm	1	SB7805SM-17
18 mm	1	SB7805SM-18
19 mm	1	SB7805SM-19
20 mm	1	SB7805SM-20
21 mm	1	SB7805SM-21
22 mm	1	SB7805SM-22
23 mm	1	SB7805SM-23
24 mm	1	SB7805SM-24
25 mm	1	SB7805SM-25
26 mm	1	SB7805SM-26
27 mm	1	SB7805SM-27
28 mm	1	SB7805SM-28
29 mm	1	SB7805SM-29
30 mm	1	SB7805SM-30
32 mm	1	SB7805SM-32
34 mm	1	SB7805SM-34

SB: Retail pack on a plastic info card

1/2" Square Drive Deep Sockets with Imperial Hex Profile



7805SZ

1.3/16 in	1	7805SZ-1.3/16
1.1/4 in	1	7805SZ-1.1/4
1.5/16 in	1	7805SZ-1.5/16
1.3/8 in	1	7805SZ-1.3/8
1.7/16 in	1	7805SZ-1.7/16
1.1/2 in	1	7805SZ-1.1/2



1/2" Square Drive Sockets with Metric Bi-Hex Profile



7800DM

8 mm	10	7800DM-8	
9 mm	10	7800DM-9	
10 mm	10	7800DM-10	
11 mm	10	7800DM-11	
12 mm	10	7800DM-12	
13 mm	10	7800DM-13	
14 mm	10	7800DM-14	
15 mm	10	7800DM-15	
16 mm	10	7800DM-16	
17 mm	10	7800DM-17	
18 mm	10	7800DM-18	
19 mm	10	7800DM-19	
20 mm	10	7800DM-20	
21 mm	10	7800DM-21	
22 mm	10	7800DM-22	
23 mm	10	7800DM-23	
24 mm	10	7800DM-24	
25 mm	10	7800DM-25	
26 mm	10	7800DM-26	
27 mm	10	7800DM-27	
28 mm	10	7800DM-28	
29 mm	10	7800DM-29	
30 mm	10	7800DM-30	
31 mm	10	7800DM-31	
32 mm	10	7800DM-32	
33 mm	10	7800DM-33	
34 mm	10	7800DM-34	
36 mm	10	7800DM-36	
<hr/>			
8 mm	1	SB7800DM-8	
9 mm	1	SB7800DM-9	
10 mm	1	SB7800DM-10	
11 mm	1	SB7800DM-11	
12 mm	1	SB7800DM-12	
13 mm	1	SB7800DM-13	
14 mm	1	SB7800DM-14	
15 mm	1	SB7800DM-15	
16 mm	1	SB7800DM-16	
17 mm	1	SB7800DM-17	
18 mm	1	SB7800DM-18	
19 mm	1	SB7800DM-19	
21 mm	1	SB7800DM-20	
21 mm	1	SB7800DM-21	
22 mm	1	SB7800DM-22	
23 mm	1	SB7800DM-23	
24 mm	1	SB7800DM-24	
25 mm	1	SB7800DM-25	
26 mm	1	SB7800DM-26	
27 mm	1	SB7800DM-27	
28 mm	1	SB7800DM-28	
29 mm	1	SB7800DM-29	
30 mm	1	SB7800DM-30	
31 mm	1	SB7800DM-31	
32 mm	1	SB7800DM-32	
33 mm	1	SB7800DM-33	
34 mm	1	SB7800DM-34	
36 mm	1	SB7800DM-36	

SB: Retail pack on a plastic info card

1/2" Square Drive Sockets with Imperial Bi-Hex Profile



7800DZ

5/16 in	10	7800DZ-5/16	
11/32 in	10	7800DZ-11/32	
3/8 in	10	7800DZ-3/8	
13/32 in	10	7800DZ-13/32	
7/16 in	10	7800DZ-7/16	
1/2 in	10	7800DZ-1/2	
9/16 in	10	7800DZ-9/16	
19/32 in	10	7800DZ-19/32	
5/8 in	10	7800DZ-5/8	
11/16 in	10	7800DZ-11/16	
3/4 in	10	7800DZ-3/4	
25/32 in	10	7800DZ-25/32	
13/16 in	10	7800DZ-13/16	
7/8 in	10	7800DZ-7/8	
15/16 in	10	7800DZ-15/16	
1 in	10	7800DZ-1	
1 1/16 in	10	7800DZ-1.1/16	
1 1/8 in	10	7800DZ-1.1/8	
1 3/16 in	10	7800DZ-1.3/16	
1 1/4 in	10	7800DZ-1.1/4	
1.5/16 in	10	7800DZ-1.5/16	
1.3/8 in	10	7800DZ-1.3/8	
1.7/16 in	1	7800DZ-1.7/16	
1.1/2 in	10	7800DZ-1.1/2	
<hr/>			
3/8 in	1	SB7800DZ-3/8	
7/16 in	1	SB7800DZ-7/16	
1/2 in	1	SB7800DZ-1/2	
9/16 in	1	SB7800DZ-9/16	
19/32 in	1	SB7800DZ-19/32	
5/8 in	1	SB7800DZ-5/8	
11/16 in	1	SB7800DZ-11/16	
3/4 in	1	SB7800DZ-3/4	
25/32 in	1	SB7800DZ-25/32	
13/16 in	1	SB7800DZ-13/16	
7/8 in	1	SB7800DZ-7/8	
15/16 in	1	SB7800DZ-15/16	
1 in	1	SB7800DZ-1	
1.1/16 in	1	SB7800DZ-1.1/16	
1.1/8 in	1	SB7800DZ-1.1/8	
1.3/16 in	1	SB7800DZ-1.3/16	
1.1/4 in	1	SB7800DZ-1.1/4	
1.5/16 in	1	SB7800DZ-1.5/16	

SB: Retail pack on a plastic info card

1/2" Square Drive Sockets with Imperial Hex Profile



7800SZ

3/8 in	10	7800SZ-3/8	
7/16 in	10	7800SZ-7/16	
1/2 in	10	7800SZ-1/2	
9/16 in	10	7800SZ-9/16	
11/16 in	10	7800SZ-11/16	
3/4 in	10	7800SZ-3/4	
13/16 in	10	7800SZ-13/16	
7/8 in	10	7800SZ-7/8	
1 3/16 in	10	7800SZ-1.3/16	

1/2" Square Drive Deep Sockets with Metric Bi-Hex Profile



7805DM

10 mm	10	7805DM-10	
12 mm	10	7805DM-12	
13 mm	10	7805DM-13	
14 mm	10	7805DM-14	
15 mm	10	7805DM-15	
16 mm	10	7805DM-16	
17 mm	10	7805DM-17	
18 mm	10	7805DM-18	
19 mm	10	7805DM-19	
21 mm	10	7805DM-21	
22 mm	10	7805DM-22	
23 mm	10	7805DM-23	
24 mm	10	7805DM-24	
26 mm	10	7805DM-26	
27 mm	10	7805DM-27	
30 mm	10	7805DM-30	
32 mm	10	7805DM-32	
34 mm	10	7805DM-34	
<hr/>			
10 mm	1	SB7805DM-10	
12 mm	1	SB7805DM-12	
13 mm	1	SB7805DM-13	
14 mm	1	SB7805DM-14	
15 mm	1	SB7805DM-15	
16 mm	1	SB7805DM-16	
17 mm	1	SB7805DM-17	
18 mm	1	SB7805DM-18	
19 mm	1	SB7805DM-19	
21 mm	1	SB7805DM-21	
22 mm	1	SB7805DM-22	
23 mm	1	SB7805DM-23	

24 mm	1	SB7805DM-24
26 mm	1	SB7805DM-26
27 mm	1	SB7805DM-27
30 mm	1	SB7805DM-30
32 mm	1	SB7805DM-32
34 mm	1	SB7805DM-34

SB: Retail pack on a plastic info card

1/2" Square Drive Deep Sockets with Imperial Bi-Hex Profile



7805DZ

5/8 in	10	7805DZ-5/8
11/16 in	10	7805DZ-11/16
3/4 in	10	7805DZ-3/4
13/16 in	10	7805DZ-13/16
7/8 in	10	7805DZ-7/8
15/16 in	10	7805DZ-15/16
1 in	10	7805DZ-1
1.1/16 in	10	7805DZ-1.1/16
1.1/8 in	10	7805DZ-1.1/8
1.13/16 in	10	7805DZ-1.3/16
1.1/4 in	10	7805DZ-1.1/4
1.5/16 in	10	7805DZ-1.5/16
1.3/8 in	10	7805DZ-1.3/8
1.7/16 in	10	7805DZ-1.7/16
1.1/2 in	10	7805DZ-1.1/2

1/2" Square Drive Sockets with TORX® Profile



7800TORX-E

E8	1	7800TORX-E8
E10	1	7800TORX-E10
E11	1	7800TORX-E11
E12	1	7800TORX-E12
E14	1	7800TORX-E14
E16	1	7800TORX-E16
E18	1	7800TORX-E18
E20	1	7800TORX-E20
E24	1	7800TORX-E24
E8	1	SB7800TORX-E8
E10	1	SB7800TORX-E10
E11	1	SB7800TORX-E11
E12	1	SB7800TORX-E12

E14	1	SB7800TORX-E14
E16	1	SB7800TORX-E16
E18	1	SB7800TORX-E18
E20	1	SB7800TORX-E20
E24	1	SB7800TORX-E24

SB: Retail pack on a plastic info card

1/2" Square Drive Speeders with Rotary Steel Handle



8152-1/2

425 mm	1	8152-1/2

1/2" Square Drive Swivel Head Breaker Bars



8157

257 mm	1	8157-10
390 mm	1	8157-15
600 mm	1	8157-24
900 mm	10	8157-36
257 mm	1	SB8157-10
390 mm	1	SB8157-15
600 mm	1	SB8157-24
900 mm	1	SB8157-36

1/2" Square Drive Swivel Head Breaker Bars with Matte Finish



8158

270 mm	1	8158-10
390 mm	1	8158-15
270 mm	1	SB8158-10
390 mm	1	SB8158-15

1/2" Square Drive Offset Handles



8167-1/2

180 mm	10	8167

1/2" Square Drive Sliding T-Handles



8154

280 mm	1	SB8154-11
280 mm	10	8154-11

3/8" to 1/2" Adaptor Sliding Head



7772H

3/8"	1/2"	10	7772H

1/2" Square Drive Extension Bars



8160

75 mm	10	8160-3
125 mm	10	8160-5
250 mm	10	8160-10
75 mm	1	SB8160-3
125 mm	1	SB8160-5
250 mm	1	SB8160-10



1/2" Square Drive Wobbler Extension Bars



8159-W - 8162-W

75 mm	10	8160W-3
125 mm	10	8160W-5
250 mm	10	8160W-10

1/2" Square Drive Universal Joints for Smooth Operations



8168

62 mm	1	8168

1/2" Square Drive to 3/4" Socket Increasing Adaptors



8172

1/2"	3/4"	10	8172
1/2"	3/4"	1	SB8172

1/2" Square Drive Locking Extension Bars



8160-B

125 mm	1	8160-B

1/2" Square Drive to 3/8" Socket Decreasing Adaptors



8171

1/2"	3/8"	10	8171
1/2"	3/8"	1	SB8171

1/2" Square Drive to 3/4" Socket Increasing Flat Adaptors



8967

1/2"	3/4"	1	8967

1/2" Square Drive Universal Joints



8166

72 mm	10	8166
72 mm	1	SB8166

Combination Stepped Hexagon Keys for Internal Lug Valve Sizes



8195-key

140 g	50	8195-KEY

For using with 8195-R

1/2" Square Drive Adaptors for 5/16" Hex Screwdriver Bit



7106S

5/16 in	10	8174A

1/2" Square Drive Bit Locking Adaptors for 5/16" Hex Screwdriver Bit



7809HL



5/16 in



1 7809HL

Spare Part Kit for 8169-1/2 Breaking Bar



SP120



75 g



1 SP120

Spare Part Kit for 8170-1/2 Breaking Bar



SP120XL



55 g



1 SP120XL

Rail-Clips for 1/2" Sockets/Socket Drivers



C1/2



19 mm



25 CLIPS-1/2

1/2" Square Drive Socket Drivers for Slotted Head Screw 60 mm



7809F



0.8 mm

1 mm



8 mm

10 mm



5 7809F-8

5 7809F-10

1/2" Square Drive Socket Drivers for Pozidriv Head Screw 60 mm



7809PZ



2

1 7809PZ-2

3

1 7809PZ-3

1/2" Square Drive Socket Drivers for TORX® Head Screw



7809TORX



T20	1	7809TORX-T20
T25	1	7809TORX-T25
T27	1	7809TORX-T27
T30	1	7809TORX-T30
T40	1	7809TORX-T40
T45	1	7809TORX-T45
T50	1	7809TORX-T50
T55	1	7809TORX-T55
T60	1	7809TORX-T60
T70	10	7809TORX-T70
T20	1	SB7809TORX-T20
T25	1	SB7809TORX-T25
T27	1	SB7809TORX-T27
T30	1	SB7809TORX-T30
T40	1	SB7809TORX-T40
T45	1	SB7809TORX-T45
T50	1	SB7809TORX-T50
T55	1	SB7809TORX-T55
T60	1	SB7809TORX-T60

1/2" Square Drive Socket Drivers for Phillips Head Screw 23 mm



7809PH



2

1 7809PH-2

3

1 7809PH-3

4

1 7809PH-4

SB: Retail pack on a plastic info card



1/2" Socket Drivers for TORX® Head Screws



7809TORX L



T20	80 mm	1	7809TORX-T20-120
T25	80 mm	1	7809TORX-T25-120
T27	80 mm	1	7809TORX-T27-120
T30	80 mm	1	7809TORX-T30-120
T40	82 mm	1	7809TORX-T40-120
T45	80 mm	1	7809TORX-T45-120
T50	62 mm	1	7809TORX-T50-100
T55	80 mm	1	7809TORX-T55-120
T60	80 mm	1	7809TORX-T60-120
T70	102 mm	5	7809TORX-T70-140

1/2" Square Drive Socket Driver Set for TORX® Head Screw



7809TO

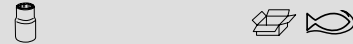

9	1	7809TO
---	---	--------

7809TORX-T27, 7809TORX-T20, 7809TORX-T25, 7809TORX-T30, 7809TORX-T50, 7809TORX-T40, 7809TORX-T45, 7809TORX-T60, 7809TORX-T55

1/2" Square Drive Socket Drive Set for Torx® Head Screws - 9 pcs



7800TORX/9



800 g	1	7800TORX/9
-------	---	------------

7800TORX-E8, 7800TORX-E10, 7800TORX-E11, 7800TORX-E12, 7800TORX-E14, 7800TORX-E16, 7800TORX-E18, 7800TORX-E20, 7800TORX-E24

1/2" Square Drive Socket Drivers for Hex Head Screw



7809M

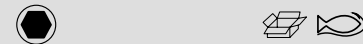

4 mm	10	7809M-4
5 mm	1	7809M-5
6 mm	1	7809M-6
7 mm	1	7809M-7
8 mm	1	7809M-8
9 mm	1	7809M-9
10 mm	1	7809M-10
12 mm	1	7809M-12
14 mm	1	7809M-14
17 mm	1	7809M-17
19 mm	1	7809M-19
4 mm	1	SB7809M-4
5 mm	1	SB7809M-5
6 mm	1	SB7809M-6
7 mm	1	SB7809M-7
8 mm	1	SB7809M-8
9 mm	1	SB7809M-9
10 mm	1	SB7809M-10
12 mm	1	SB7809M-12
14 mm	1	SB7809M-14
17 mm	1	SB7809M-17
19 mm	1	SB7809M-19

SB: Retail pack on a plastic info card

1/2" Socket Drivers for Hex Head Screws



7809M L



4 mm	80 mm	1	7809M-4-120
5 mm	80 mm	1	7809M-5-120
5 mm	143 mm	1	7809M-5-180
6 mm	80 mm	1	7809M-6-120

7 mm	63 mm	1	7809M-7-100
8 mm	83 mm	1	7809M-8-120
10 mm	80 mm	1	7809M-10-120
12 mm	80 mm	1	7809M-12-120
14 mm	80 mm	10	7809M-14-120
17 mm	80 mm	10	7809M-17-120
19 mm	80 mm	8	7809M-19-120
5 mm	140 mm	1	SB7809M-5-180
7 mm	63 mm	1	SB7809M-7-100
8 mm	81 mm	1	SB7809M-8-120

1/2" Square Drive Socket Driver Set for Hex Head Screw



7808HM

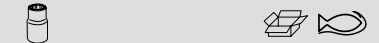

8	1	7808HM
---	---	--------

7809M-4, 7809M-6, 7809M-8, 7809M-7, 7809M-5, 7809M-10, 7809M-12, 7809M-14

1/2" Square Drive Socket Drivers for Imperial Hex Head Screw



7809Z

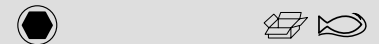

1/4 in	1	7809Z-3/16
5/16 in	1	7809Z-1/4
3/8 in	1	7809Z-5/16
7/16 in	1	7809Z-3/8
1/2 in	1	7809Z-7/16
17/32 in	1	7809Z-1/2
9/16 in	1	7809Z-17/32
19/32 in	1	7809Z-9/16
5/8 in	1	7809Z-19/32
5/8 in	1	7809Z-5/8

1/2" Square Drive Socket Drivers for Multipoint Head Screw



7809XZN

Size	Quantity	Part Number
6	1	7809XZN-6
8	1	7809XZN-8
8	1	7809XZN-8-100
10	1	7809XZN-10
10	1	7809XZN-10-100
12	1	7809XZN-12
12	1	7809XZN-12-100
14	1	7809XZN-14
14	1	7809XZN-14-100
16	1	7809XZN-16
18	1	7809XZN-18

1/2" Round Head Reversible Ratchets with 72 Teeth and 5° Action Angle



8150RN-1/2

Length	Teeth	Quantity	Part Number
267 mm	72	1	8150RN-1/2
267 mm	72	1	SB8150RN-1/2

SB: With hanging clip

1/2" Reversible Ratchets with 60 Teeth and Dual Pawl



8195-R

Length	Teeth	Quantity	Part Number
260 mm	60	1	8195-R

1/2" Slim Head Reversible Ratchets with 72 Teeth and 5° Action Angle



8150SL

Length	Teeth	Quantity	Part Number
264 mm	72	1	8150SL

1/2" Pear Head Reversible Ratchets with 60 Teeth and 6° Action Angle



SBS81

Length	Teeth	Quantity	Part Number
250 mm	60	5	SBS81

Radiator Valve Ratchet Set - 3 Pcs/Plastic Pouch



8195-SET

Dimensions	Quantity	Part Number
350 x 20 x 80 mm	5	8195-SET

- 8195-R
- 8195-SQ
- 8195-KEY

1/2" Pear Head Reversible Ratchets with 80 Teeth and 4.5° Action Angle



8150-1/2

Length	Teeth	Quantity	Part Number
269 mm	80	1	8150-1/2
269 mm	80	1	SB8150-1/2

SB: With hanging clip

1/2" Swivel Head Ratchets with 72 Teeth and 5° Action Angle



8120-1/2

Length	Teeth	Quantity	Part Number
266 mm	72	12	8120-1/2

1/2" Flex Head Reversible Ratchets with 32 Teeth and 11.25° Action Angle



8110H-1/2

Length	Teeth	Quantity	Part Number
440 mm	32	1	8110H-1/2



Fitting Square Drives for 8193-1/2 1/2" Ratchet



8194-1/2

32 mm	1	8194-1/2

Fitting Square Drives for 8195-R 1/2" Reversible Ratchet



8195-SQ

37.5 mm	40 g	25	8195-SQ

Ratcheting Adaptors with 52 Teeth for 1/2" Ratchet



8151-1/2

71 mm	1	8151-1/2

Spare Part Kit for 8150SL 1/2" Ratchet



8150SL-SPARE

12	8150SL	1	8150SL-SPARE

Spare Part Kit for 8150-1/2 1/2" Ratchet



8150-1/2-SPARE

11	8150-1/2	1	8150-1/2-SPARE

Spare Part Kit for 8150RN-1/2 1/2" Ratchet



8150RN-1/2-SPARE

6	8150RN-1/2	1	8150RN-1/2-SPARE

3/4"

3/4" Square Drive Sockets with Metric Hex Profile



8900SM

19 mm	1	8900SM-19
22 mm	1	8900SM-22
23 mm	1	8900SM-23
24 mm	5	8900SM-24
26 mm	5	8900SM-26
27 mm	5	8900SM-27
28 mm	1	8900SM-28
29 mm	1	8900SM-29
30 mm	5	8900SM-30
32 mm	5	8900SM-32
33 mm	1	8900SM-33
34 mm	1	8900SM-34
35 mm	1	8900SM-35
36 mm	5	8900SM-36
38 mm	1	8900SM-38
41 mm	5	8900SM-41
42 mm	1	8900SM-42
46 mm	1	8900SM-46
50 mm	1	8900SM-50
55 mm	1	8900SM-55
60 mm	1	8900SM-60

3/4" Square Drive Sockets with Imperial Hex Profile



8900SZ

3/4 in	1	8900SZ-3/4
13/16 in	1	8900SZ-13/16
1 in	1	8900SZ-1
1.7/16 in	1	8900SZ-1.7/16
1.9/16 in	1	8900SZ-1.9/16
1.7/8 in	1	8900SZ-1.7/8
2 in	1	8900SZ-2

3/4" Square Drive Sockets with Metric Bi-Hex Profile



8900DM



19 mm	1	8900DM-19
21 mm	5	8900DM-21
22 mm	1	8900DM-22
23 mm	1	8900DM-23
24 mm	1	8900DM-24
25 mm	1	8900DM-25
26 mm	1	8900DM-26
27 mm	1	8900DM-27
28 mm	1	8900DM-28
29 mm	1	8900DM-29
30 mm	5	8900DM-30
32 mm	1	8900DM-32
33 mm	1	8900DM-33
34 mm	1	8900DM-34
35 mm	1	8900DM-35
36 mm	1	8900DM-36
37 mm	1	8900DM-37
38 mm	1	8900DM-38
40 mm	1	8900DM-40
41 mm	5	8900DM-41
42 mm	1	8900DM-42
46 mm	1	8900DM-46
47 mm	1	8900DM-47
50 mm	5	8900DM-50
52 mm	1	8900DM-52
40 mm	3	8900DM-54
55 mm	1	8900DM-55
56 mm	1	8900DM-56
60 mm	5	8900DM-60

3/4" Square Drive Sockets with Imperial Bi-Hex Profile



8900DZ



3/4 in	1	8900DZ-3/4
13/16 in	1	8900DZ-13/16
7/8 in	1	8900DZ-7/8
15/16 in	1	8900DZ-15/16
31/32 in	1	8900DZ-31/32
1 in	1	8900DZ-1
1 1/16 in	1	8900DZ-1.1/16
1 1/8 in	1	8900DZ-1.1/8
1 1/4 in	1	8900DZ-1.1/4
1 5/16 in	5	8900DZ-1.5/16
1 3/8 in	1	8900DZ-1.3/8
1 1/2 in	1	8900DZ-1.1/2
1.9/16 in	1	8900DZ-1.9/16
1 5/8 in	1	8900DZ-1.5/8
1.11/16 in	1	8900DZ-1.11/16
1 3/4 in	1	8900DZ-1.3/4
1 13/16 in	1	8900DZ-1.13/16



1 7/8 in	1	8900DZ-1.7/8
2 in	1	8900DZ-2
2.1/16 in	1	8900DZ-2.1/16
2 1/8 in	1	8900DZ-2.1/8
2.3/16 in	1	8900DZ-2.3/16
2 1/4 in	1	8900DZ-2.1/4
2 3/8 in	1	8900DZ-2.3/8

3/4" Square Drive Telescopic Handle with Matte Finish



8953E-32



495 to 810 mm 1 8953E-32

3/4" Universal Handles with Nickel and Chrome Finish



8952N/B



450 mm 1 8952N/B

3/4" Square Drive Sliding T-Handles



8954



390 mm 1 8954-15

3/4" Square Drive Sliding T-Heads



8954A



62 mm 1 8954A

3/4" Square Drive Flex Head Breaker Bars



8957-19



480 mm 1 8957-19

3/4" Square Drive Flex Heads for 8958 Breaker Bar



8958A



125 mm 1 8958A

3/4" Square Drive Flex Heads for 8957 Breaker Bar



8957A



140 mm 1 8957A

3/4" Square Drive Offset Handles



8963



415 mm 1 8963



3/4" Square Drive Extension Bars



8961/8962

200 mm	1	8960-8
400 mm	12	8960-16

3/4" Square Drive to 1" Socket Increasing Adaptors



9564

3/4"	1"	1	8972

Round Heads with 72 Teeth for 3/4" Reversible Ratchet



8950N/A

170 mm	72	1	8950RN/A

3/4" Square Drive Universal Joints



8966

120 mm	1	8966

3/4" Round Head Reversible Ratchets with 72 Teeth and 5° Action Angle



8950N

525 mm	72	1	8950RN

Pear Heads with 24 Teeth for 3/4" Reversible Ratchet



8955N/A

152 mm	24	1	8955N/A

3/4" Square Drive to 1/2" Socket Decreasing Adaptors



8965

3/4"	1/2"	1	8971

3/4" ratchets.



8955N

525 mm	24	1	8955N

3/4" Universal handle



8955N/B

1160 g	390 mm	5	8955N/B

Ratcheting Adaptors with 72 Teeth for 3/4" Ratchet



8951

95.5 mm	1	8951

Spare Part Kit for 8950 N and 8950N/A 3/4" Ratchet



8950NA-SO/2

8	8950N, 8950N/A	1	8950NA-SO/2

Spare Part Kit for 8955N and 8955N/A 3/4" Ratchet



8955N-SPARE

11	8955N, 8955N/A	1	8955N-SPARE

1"

1" Square Drive Sockets with Metric Hex Profile



9500SM

41 mm	1	9500SM-41
46 mm	1	9500SM-46
50 mm	1	9500SM-50
54 mm	1	9500SM-54
55 mm	1	9500SM-55
58 mm	1	9500SM-58
60 mm	1	9500SM-60
63 mm	1	9500SM-63
65 mm	1	9500SM-65
67 mm	1	9500SM-67
70 mm	1	9500SM-70
71 mm	1	9500SM-71
75 mm	1	9500SM-75
77 mm	1	9500SM-77
80 mm	1	9500SM-80
82 mm	1	9500SM-82

1" Square Drive Sockets with Imperial Bi-Hex Profile



9500DZ

1.5/8 in	1	9500DZ-1.5/8
1.13/16 in	1	9500DZ-1.13/16
1.7/8 in	1	9500DZ-1.7/8
2 in	1	9500DZ-2
2.1/8 in	1	9500DZ-2.1/8
2.3/16 in	1	9500DZ-2.3/16
2.1/4 in	1	9500DZ-2.1/4
2.3/8 in	1	9500DZ-2.3/8
2.1/2 in	1	9500DZ-2.1/2
2.9/16 in	1	9500DZ-2.9/16
2.5/8 in	1	9500DZ-2.5/8
2.3/4 in	1	9500DZ-2.3/4
2.15/16 in	1	9500DZ-2.15/16
3 in	1	9500DZ-3
3.1/8 in	1	9500DZ-3.1/8

1" Square Drive Flex Head Universal Joints with Matte Finish



9566A

167 mm	1	9566A

1" Square Drive Sliding T-Handles with Matte Finish



9555

508 mm	1	9555

1" Square Drive Sliding T-Heads



9555AB

78x78x78 mm	1	9555AB

1" Square Drive Extension Bars with Matte Finish



9560AB/9563AB

200 mm	1	9560AB
440 mm	1	9563AB



1" Square Drive to 3/4" Socket Decreasing Adaptors with Matte Finish



9565AB

3/4"	1	9565AB

1" Round Head Reversible Ratchets with 72 Teeth and 5° Action Angle



9550N

640 mm	72	1 9550N

1" Square Drive Interchangeable Handle Bar for Ratcheting Heads



9550N/B

1960 g	1	9550N/B

Round Heads with 72 Teeth for 1" Reversible Ratchet



9550N/A

195 mm	72	1 9550N/A

Spare Part Kit for 9550 N and 9550N/A 1" Ratchet



9550N-SPARE

2	9550N, 9550N/A	1	9550N-SPARE

EMPTY SOCKET SET CASES

Empty Cases with Divider for Socket Set



-CASE

110 x 375 x 430 mm	2200 g	1	S103-CASE
100 x 215 x 370 mm	1120 g	1	S240AF-CASE
70 x 160 x 280 mm	500 g	1	S330-CASE
110 x 320 x 375 mm	1620 g	1	S400-CASE
110 x 320 x 375 mm	1620 g	1	S410-CASE
100 x 215 x 375 mm	1120 g	1	S460-CASE
100 x 215 x 375 mm	1120 g	1	S560-CASE

110 x 375 x 430 mm	2200 g	1	S81MIX-CASE
110 x 375 x 430 mm	2200 g	1	S108-CASE
110 x 375 x 430 mm	2200 g	1	SLX17-CASE
100 x 215 x 375 mm	1120 g	1	S330L-CASE

Injected Thin Walled Empty Spare Cases



4750IB

35 x 80 x 100 mm	1	SPAR-CASE-A7
35 x 85 x 160 mm	1	SPAR-CASE-A6
49 x 152 x 280 mm	1	SPAR-CASE-A4

SCAFFOLDING WRENCHES

Double Metric Bi-Hex Scaffolding Wrench



SC2RM

13-17 mm	10	SC2RM-13-17
15-17 mm	10	SC2RM-15-17
19-22 mm	10	SC2RM-19-22
27-30 mm	1	SC2RM-27-30



Torque Tools



DIGITAL TORQUE WRENCHES

Digital Torque and Angle Slim Bluetooth® Wrench with Memory and Rectangular Interchangeable Head

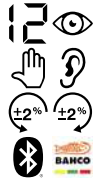

TAWMB MICRO

mm	Nm	Nm	
9x12 mm	1.5-30 N·m	0.01 N·m	1 TAWMB930M
9x12 mm	6.8-135 N·m	0.1 N·m	1 TAWMB9135M

Accuracy: 20% to 100% of full scale

Digital Torque and Angle Bluetooth® Wrench with Memory and Rectangular Interchangeable Head



TAWMB14_24

mm	Nm	Nm	
14x18 mm	17-340 N·m	1 N·m	1 TAWMB14340
24x32 mm	32.5-650 N·m	1 N·m	1 TAWMB24650
24x32 mm	40-800 N·m	1 N·m	1 TAWMB24800

Accuracy: 20% to 100% of full scale

Electronic Torque and Angle Slim Wrench with Memory/USB and Fixed Ratchet Head



TAWM MICRO

mm	Nm	Nm	
1/4 in	0.6-12 N·m	0.01 N·m	1 TAWM1412M
1/4 in	1.5-30 N·m	0.01 N·m	1 TAWM1430M
3/8 in	6.8-135 N·m	0.1 N·m	1 TAWM38135M

Accuracy: 20% to 100% of full scale

Electronic Torque and Angle Slim Wrench with Memory/USB and Rectangular Interchangeable Head



TAWM9 MICRO

mm	Nm	Nm	
9x12 mm	0.6-12 N·m	0.01 N·m	1 TAWM912M
9x12 mm	1.5-30 N·m	0.01 N·m	1 TAWM930M
9x12 mm	6.8-135 N·m	0.1 N·m	1 TAWM9135M

Accuracy: 20% to 100% of full scale

Electronic Torque and Angle Wrench with Memory/USB and Fixed Ratchet Head. with memory and USB data download



TAWM

	Nm	Nm	
3/8 in	7-135 N·m	1 N·m	1 TAWM38135
1/2 in	17-340 N·m	1 N·m	1 TAWM12340
3/4 in	40-800 N·m	1 N·m	1 TAWM34800

Accuracy: 20% to 100% of full scale

Electronic Torque and Angle Wrench with Memory/USB and Rectangular Interchangeable Head



TAWM9_14_24

mm	Nm	Nm	
9x12 mm	7-135 N·m	1 N·m	1 TAWM9135
14x18 mm	17-340 N·m	1 N·m	1 TAWM14340
24x32 mm	40-800 N·m	1 N·m	1 TAWM24800

Accuracy: 20% to 100% of full scale

Electronic Torque and Thin Angle Wrench with Fixed Ratchet Head



TAW MICRO

mm	Nm	Nm	Icons	Model
1/4 in	0.6-12 N·m	0.01 N·m		1 TAW1412M
1/4 in	1.5-30 N·m	0.01 N·m		1 TAW1430M
3/8 in	6.8-135 N·m	0.1 N·m		1 TAW38135M

Accuracy: 20% to 100% of full scale

Electronic Torque and Angle Slim Wrench with Rectangular Interchangeable Head



TAW9 MICRO

mm	Nm	Nm	Icons	Model
9x12 mm	0.6-12 N·m	0.01 N·m		1 TAW912M
9x12 mm	1.5-30 N·m	0.01 N·m		1 TAW930M
9x12 mm	6.8-135 N·m	0.1 N·m		1 TAW9135M

Accuracy: 20% to 100% of full scale

Electronic Torque and Angle Wrench with Fixed Ratchet Head



TAW

mm	Nm	Nm	Icons	Model
3/8 in	7-135 N·m	1 N·m		1 TAW38135
1/2 in	17-340 N·m	1 N·m		1 TAW12340
3/4 in	40-800 N·m	1 N·m		1 TAW34800

Accuracy: 20% to 100% of full scale

Electronic Torque and Angle Wrench with Rectangular Interchangeable Head



TAW9 14 24

mm	Nm	Nm	Icons	Model
9x12 mm	7-135 N·m	1 N·m		1 TAW9135
14x18 mm	17-340 N·m	1 N·m		1 TAW14340
24x32 mm	40-800 N·m	1 N·m		1 TAW24800

Accuracy: 20% to 100% of full scale

Electronic Torque Wrench with Rectangular Interchangeable Head



IZO-D

mm	Nm	Nm	Icons	Model
1/4 in	3-30 N·m	0.1 N·m		1 IZO-D-30
3/8 in	13.5-135 N·m	1 N·m		1 IZO-D-135
1/2 in	20-200 N·m	1 N·m		1 IZO-D-200
1/2 in	34-340 N·m	1 N·m		1 IZO-D-340

Electronic Torque Wrench with Fixed Ratchet Head. ring spanner



IZO-DR

mm	Nm	Nm	Icons	Model
3/4 in	81-810 N·m	1 N·m		1 IZO-DR-810



MECHANICAL TORQUE WRENCHES

Mechanical Adjustable Torque Click Wrench with Window Scale and Fixed Ratchet Head



74WR-15/74WR-25

mm	Nm	Nm	Qty	Part No.
1/4 in	3-15 N·m	0.1 N·m	1	74WR-15
1/4 in	5-25 N·m	0.2 N·m	1	74WR-25

Mechanical Adjustable Torque Click Wrench with Window Scale and Fixed Push-Through Ratchet Head

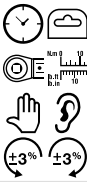

74WR-50/74WR-400

mm	Nm	Nm	Qty	Part No.
3/8"	10-50 N·m	0.5 N·m	1	74WR-50
3/8"	20-100 N·m	1 N·m	1	74WR-100B
1/2"	20-100 N·m	1 N·m	1	74WR-100
1/2"	40-200 N·m	2 N·m	1	74WR-200
1/2"	60-300 N·m	2 N·m	1	74WR-300
1/2"	60-340 N·m	5 N·m	1	74WR-340
3/4"	80-400 N·m	5 N·m	1	74WR-400

Mechanical Adjustable Torque Click Wrench with Window Scale and Rectangular Interchangeable Head



74W9/74W14

mm	Nm	Nm	Qty	Part No.
9x12 mm	3-15 N·m	0.2 N·m	1	74W9-15
9x12 mm	5-25 N·m	0.2 N·m	1	74W9-25
9x12 mm	10-50 N·m	0.5 N·m	1	74W9-50

mm	Nm	Nm	Qty	Part No.
9x12 mm	20-100 N·m	1 N·m	1	74W9-100
9x12 mm	40-200 N·m	1 N·m	1	74W9-200
14x18 mm	40-200 N·m	2 N·m	1	74W14-200
14x18 mm	60-300 N·m	2 N·m	1	74W14-300
14x18 mm	80-400 N·m	5 N·m	1	74W14-400

Mechanical Adjustable Torque Click Wrench with Window Scale and Spigot Interchangeable Head

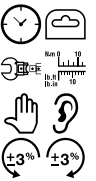

74WS-15/74WS-300

mm	Nm	Nm	Qty	Part No.
16 mm	3-15 N·m	0.2 N·m	1	74WS-15
16 mm	5-25 N·m	0.2 N·m	1	74WS-25
16 mm	10-50 N·m	0.5 N·m	1	74WS-50
16 mm	20-100 N·m	1 N·m	1	74WS-100
16 mm	40-200 N·m	2 N·m	1	74WS-200
16 mm	60-300 N·m	2 N·m	1	74WS-300

Mechanical Adjustable Torque Click Wrench with Marked Scale and Fixed Ratchet Head

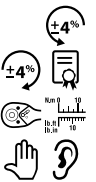

7455

mm	Nm	Nm	Qty	Part No.
1/4 in	1-5 N·m	0.05 N·m	1	7455-5
1/4 in	3-15 N·m	0.1 N·m	1	7455-15
1/4 in	4-20 N·m	0.1 N·m	1	7455-20
1/4 in	5-25 N·m	0.1 N·m	1	7455-25
3/8 in	12-60 N·m	0.5 N·m	1	7455-60
3/8 in	20-100 N·m	0.5 N·m	1	7455-100
1/2 in	20-100 N·m	0.5 N·m	1	7455-100A
1/2 in	40-200 N·m	2 N·m	1	7455-200
1/2 in	60-300 N·m	2 N·m	1	7455-300
1/2 in	68-340 N·m	2 N·m	1	7455-340
3/4 in	100-500 N·m	5 N·m	1	7455-500
3/4 in	160-800 N·m	5 N·m	1	7455-800
1 in	200-1000 N·m	10 N·m	1	7455-1000

Mechanical Adjustable Torque Click Wrench with Marked Scale, Fixed Ratchet Head and 2 Section Handle

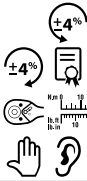

7455-1500

1 in	300-1500 N·m	10 N·m	1	7455-1500

Mechanical Adjustable Torque Click Wrench with Marked Scale, Interchangeable Head and 2 Sections Handle

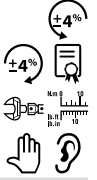

7465-1500

27x36 mm	300-1500 N·m	10 N·m	1	7465-1500

Mechanical Adjustable Torque Click Wrench with Marked Scale and Fixed Square Drive Head



7455-2500

1 in	500-2500 N·m	10 N·m	1	7455-2500

Mechanical Adjustable Torque Click Wrench with Marked Scale and Flex Ratchet Head



7456

3/8 in	10-80 lbf·ft	0.5 lbf·ft	1	7456-80LB

Mechanical Adjustable Torque Click Wrench with Marked Scale and Interchangeable Head

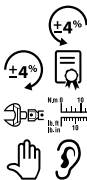

7465

9x12 mm	1-5 N·m	0.05 N·m	1	7465-5
9x12 mm	3-15 N·m	0.1 N·m	1	7465-15
9x12 mm	6-30 N·m	0.1 N·m	1	7465-30
9x12 mm	12-60 N·m	0.5 N·m	1	7465-60
9x12 mm	20-100 N·m	0.5 N·m	1	7465-100
14x18 mm	40-200 N·m	2 N·m	1	7465-200
14x18 mm	68-340 N·m	2 N·m	1	7465-340
24x32 mm	160-800 N·m	5 N·m	1	7465-800

Mechanical Adjustable Free Hand Point Torque Click Wrench with Fixed Ratchet Head



75R3/75R1

3/4" in	130-650 N·m	5 N·m	1	75R3-650
3/4" in	200-800 N·m	10 N·m	1	75R3-800
3/4" in	300-1000 N·m	10 N·m	1	75R3-1000
1" in	500-1500 N·m	10 N·m	1	75R1-1500



Mechanical Adjustable Free Hand Point Torque Click Wrench with Spigot Interchangeable Head



75S-650

22 mm	130-650 N·m	5 N·m	1	75S-650

Mechanical Adjustable Breaking Torque Wrench with Fixed Ratchet Head and Double Adjusting Bar



76R1-2000

1 in	900-2000 N·m	50 N·m	1	76R1-2000

Mechanical Adjustable Window Scale Breaking Torque Wrench with Fixed Ratchet Head

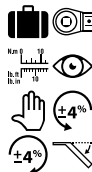

76R3

3/4-1 in	120-600 N·m	10 N·m	1	76R3-600
3/4-1 in	200-800 N·m	10 N·m	1	76R3-800
3/4-1 in	300-1000 N·m	20 N·m	1	76R3-1000

Mechanical Adjustable Window Scale Breaking Torque Click Wrench with Spigot Interchangeable Head

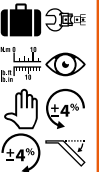

76S-600

22 mm	120-600 N·m	10 N·m	1	76S-600

Mechanical Adjustable Breaking Torque Wrench with Fixed Ratchet Head



76R3-1500

3/4 in	700-1500 N·m	25 N·m	1	76R3-1500

Mechanical Torque Wrench with Dial Scale, Fixed Square Drive Head & Metal Handle



7454 M

1/4 in	0.7-3.5 N·m	0.1 N·m	1	7454-3.5
1/4 in	1.68-8.4 N·m	0.2 N·m	1	7454-8.4
3/8 in	3.4-17 N·m	0.5 N·m	1	7454-17
3/8 in	6.4-32 N·m	0.5 N·m	1	7454-32
3/8 in	14-70 N·m	1 N·m	1	7454-70A
1/2 in	28-140 N·m	5 N·m	1	7454-140A
1/2 in	46-230 N·m	10 N·m	1	7454-230
	160-800 N·m	20 N·m	1	7454-800A

Mechanical Torque Wrench with Dial Scale, Fixed Square Drive Head and Metal Handle

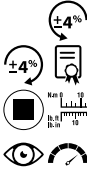

7454-480/7454-800

3/4 in	100-480 N·m	10 N·m		1	7454-480

Mechanical Torque Wrench with Dial Scale, Fixed Square Drive Head and 2 Sections Handle

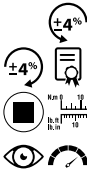

7454-1400

1 in	275-1400 N·m	25 N·m		1	7454-1400

Mechanical Torque Wrench with Dial Scale/LED and Fixed Square Drive Head



7454-800E

3/4 in	160-800 N·m	20 N·m		1	7454-800E

Mechanical Torque Wrench with Dial Scale/LED and Fixed Square Drive Head and 2 Sections Handle



7454-1400E

1 in	275-1400 N·m	25 N·m		1	7454-1400E

Mechanical Preset Torque Click Wrench with Fixed Ratchet Head



74PR-20

1/4 in	4-20 N·m	219 mm	1	74PR-20

Mechanical Preset Torque Click Wrench with Fixed Push-Through Ratchet Head



74PR-60/74PR-400

3/8 in	12-60 N·m	295 mm	1	74PR-60
1/2 in	12-60 N·m	301 mm	1	74PR-60A
3/8 in	20-100 N·m	335 mm	1	74PR-100
1/2 in	20-100 N·m	342 mm	1	74PR-100A
1/2 in	40-200 N·m	425 mm	1	74PR-200
1/2 in	60-300 N·m	668 mm	1	74PR-300
3/4 in	80-400 N·m	675 mm	1	74PR-400



Mechanical Preset Torque Click Wrench with Rectangular Interchangeable Head and Plastic Handle



74P9-20

mm	Nm	L	
9x12 mm	4-20 N·m	205 mm	1 74P9-20

Mechanical Preset Torque Click Wrench with Spigot Interchangeable Head and Rubber Handle

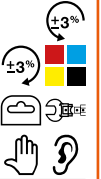

74PS-60/74PS-300

mm	Nm	L	
16 mm	12-60 N·m	283 mm	1 74PS-60
16 mm	20-100 N·m	324 mm	1 74PS-100
16 mm	40-200 N·m	405 mm	1 74PS-200
16 mm	60-300 N·m	643 mm	1 74PS-300

Mechanical Preset Torque Click Wrench with Rectangular Interchangeable Head and Rubber Handle



74P9-60/74P14-400

mm	Nm	L	
9x12 mm	12-60 N·m	286 mm	1 74P9-60
9x12 mm	20-100 N·m	326 mm	1 74P9-100
14x18 mm	40-200 N·m	403 mm	1 74P14-200
14x18 mm	60-300 N·m	534 mm	1 74P14-300
14x18 mm	80-400 N·m	652 mm	1 74P14-400

Mechanical Preset Free Hand Point Torque Click Wrench with Fixed Ratchet Head



75P3/75P1

mm	Nm	L	
3/4 in	130-650 N·m	848 mm	1 75P3-650
3/4" in	200-800 N·m	1030 mm	1 75P3-800
3/4" in	300-1000 N·m	1238 mm	1 75P3-1000
1" in	500-1500 N·m	1563 mm	1 75P1-1500

Mechanical Preset Torque Click Wrench with Spigot Interchangeable Head and Plastic Handle

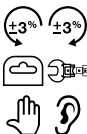

74PS-20

mm	Nm	L	
16 mm	4-20 N·m	206 mm	1 74PS-20

Mechanical Preset Free Hand Point Torque Click Wrench with Spigot Interchangeable Head

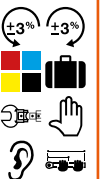

75PS-650

mm	Nm	L	
22 mm	130-650 N·m	800 mm	1 75PS-650

Handle Extension for 75 Series Torque Click Wrench



75EXT

700 mm	60 mm	1.600 kg	1	75EXT

TORQUE SCREWDRIVERS

Digital Torque and Angle Bluetooth® Screwdriver



TASMB14H

1/4 in	0.04-0.7 N·m	0.01 N·m	1	TASMB14H007
1/4 in	0.45-9 N·m	0.01 N·m	1	TASMB14H09

Accuracy: 20% to 100% of full scale

Digital Torque & Angle Screwdriver with Memory & USB



TASM14H

1/4 in	0.035-0.700 N·m	1	TASM14H007
1/4 in	0.45-9 N·m	1	TASM14H09

Electronic Torque and Angle Screwdriver



TAS14

1/4" in		0.04-0.7 N·m	1	TAS14H007
- in	1/4" in	0.04-0.7 N·m	1	TAS14S007
1/4" in		0.45-9 N·m	1	TAS14H09
	1/4" in	0.45-9 N·m	1	TAS14S09

Accuracy: 20% to 100% of full scale

Adjustable Torque Screwdriver with Window Scale



6973N-6978N

1/4 in	16-80 cNm	1 cNm	1	6973N
1/4 in	40-200 cNm	2 cNm	1	6976N
1/4 in	90-450 cNm	5 cNm	1	6978N

Adjustable Torque Mini Wrench with Fixed Screwdriver Bit



6852-5

1/4 in	1-5 N·m	0.1 N·m	1	6852-5



Adjustable Torque Mini Wrench Set with Fixed Screwdriver Bit



6852-5/S17

32 x 70 x 200 mm	0.29 kg	1	6852-5/S17

Preset Torque Screwdriver with 1/4" Hex Bit Holder



6873N-6880N

7-70 cNm	1/4 in	1/4 in	1	6876N
15-170 cNm	1/4 in	1/4 in	1	6878N
45-450 cNm	1/4 in	1/4 in	1	6880N

KM653-QR-1P

6852-5	
6700SM-4	
59S/PH0, 59S/PH1	
59S/PZ0, 59S/PZ1	
59S/H1.5	
59S/0.8-5.5, 59S/0.6-4.5	
59S/T6, 59S/T7, 59S/T8	

Adjustable Torque Screwdriver with Marked Scale in cN·m



TSS120

1/4 in	10-120 cNm	1	TSS120

Adjustable Torque Screwdriver with Marked Scale in N·m



TSS600

1/4 in	1-6 N·m	0.1 N·m	1 TSS600

Preset Torque Mini Wrench with Fixed Screwdriver Bit



6852P-5

1/4" in	1-5 N·m	157 mm	1	6852P-5

Fixed Preset ERGO™ Torque Screwdriver. With TORX® and TORX Plus® blades



BE-6990

0.6 N·m	T6	IP6	1	BE-6990-IP6
0.9 N·m	T7	IP7	1	BE-6990-IP7
1.2 N·m	T8	IP8	1	BE-6990-IP8
1.4 N·m	T9	IP9	1	BE-6990-IP9
2 N·m	T10	IP10	1	BE-6990-IP10
3 N·m	T15	IP15	1	BE-6990-IP15

Fixed Preset ERGO™ Torque Screwdriver Set



BE-6990-IPSET

40 x 170 x 215 mm	0.755 kg	1	BE-6990-IPSET

BE-6990-IP7, BE-6990-IP8, BE-6990-IP9, BE-6990-IP15



Torque Screwdriver Blades with TORX® Tip



BE-6990TX-KL



T6	1.70 mm	160 mm	10	BE-6990TX-T6-KL
T7	1.99 mm	160 mm	10	BE-6990TX-T7-KL
T8	2.31 mm	160 mm	10	BE-6990TX-T8-KL
T9	2.50 mm	170 mm	10	BE-6990TX-T9-KL
T10	2.74 mm	170 mm	10	BE-6990TX-T10KL
T15	3.27 mm	170 mm	10	BE-6990TX-T15KL

Torque Screwdriver Blades with TORX PLUS® Tip



BE-6990-IP-KL



IP6	1.50 mm	170 mm	10	BE-6990-IP6-KL
IP7	1.99 mm	170 mm	10	BE-6990-IP7-KL
IP8	2.31 mm	170 mm	10	BE-6990-IP8-KL
IP9	2.50 mm	170 mm	10	BE-6990-IP9-KL
IP10	2.74 mm	170 mm	10	BE-6990-IP10-KL
IP15	3.27 mm	170 mm	10	BE-6990-IP15-KL

Spare blade for TORX® head screws



BE-6990-IP20-KL

IP20	4.5 mm	90 mm	10	BE-6990-IP20-KL

Spare blade for TORX® head screws



BE-6990TX-T20KL

T20	4.5 mm	92 mm	10	BE-6990TX-T20KL

MULTIPLIERS

Hand Torque Multiplier with Offset and Straight Reaction Arms



89049TM-1000

1000 Nm - 3/4 in	4.8:1/4.9:1*	208/204 Nm - 1/2 in		1	89049TM-1000



Hand Torque Multiplier with Offset and Straight Reaction Arms



8905-TM/9505-TM

in	Ratio	in	Icons
1300 Nm - 3/4 in	5:1	260 Nm - 1/2 in	1 8905-TM
2700 Nm - 1 in	5:1	540 Nm - 3/4 in	1 9505-TM

Hand Torque Multiplier with Reaction Plate



9505

in	Ratio	in	Icons
3400 Nm - 1 in	5:1	680 Nm - 3/4 in	1 9505-3400

Hand Torque Multiplier with Reaction Plate and Ratcheting Locking System



9525-9625

in	Ratio	in	Icons
3400 Nm - 1 in	25:1	136 Nm - 1/2 in	1 9525-3400
9500 Nm - 1.1/2 in	25:1	380 Nm - 3/4 in	1 9625-9500

Hand Torque Multiplier with Straight Reaction Arm



95155B/9526B

in	Ratio	in	Icons
3000 Nm - 1 in	15.5:1	193 Nm - 1/2 in	1 95155B-3000
4500 Nm - 1 in	26:1	173 Nm - 1/2 in	1 9526B-4500

Compact Hand Torque Multiplier with Offset Reaction Arm



89222CR/96255CR

in	Ratio	in	Icons
1000 Nm - 3/4 in	22.2:1	45 Nm - 1/2 in	1 89222CR-1000
2000 Nm - 1 in	27:1	74 Nm - 1/2 in	1 9527CR-2000
4000 Nm - 1 in	25:1	160 Nm - 1/2 in	1 9525CR-4000
7000 Nm - 1.1/2 in	25.5:1	274 Nm - 1/2 in	1 96255CR-7000

TORQUE TESTERS

Multifunctional Testers for torque screwdrivers and wrenches



TEA003-TEA030

Nm	in	Nm	Icons
0.1-3.0 N·m	1/4 in	0.01 N·m	1 TEA003
0.5-10 N·m	1/4 in	0.01 N·m	1 TEA010
1.5-30 N·m	10 mm	0.1 N·m	1 TEA030
1.5-30 N·m	10 mm	0.1 N·m	1 TEA030A



Joint Simulators for Torque Testing Equipment



TJS

max	in	mm	Icons
3 N·m	1/4 in	31 mm	1 TJS003
10 N·m	1/4 in	31 mm	1 TJS010
30 N·m	1/4 in	31 mm	1 TJS030

Multifunctional tester for torque wrenches



TEA065-TEA2100

mm		in		Icons	
3-65 N·m	- mm	3/8 in		1	TEA065
10-350 N·m	- mm	1/2 in		1	TEA350
50-1100 N·m	27 mm	3/4 in		1	TEA1100
200-2100 N·m	27 mm			1	TEA2100

TORQUE ANGLE ADAPTORS

Electronic Torque and Angle Meter



TAM

mm		Icons	
1/4 in	1,5-30 N·m	1	TAM1430
3/8 in	6,8-135 N·m	1	TAM38135
1/2 in	6,8-135 N·m	1	TAM12135
1/2 in	10-200 N·m	1	TAM12200
1/2 in	17-340 N·m	1	TAM12340

Electronic Angle Meter



MAM

mm		Icons	
0-360°	56 mm	1	MAM50M

Angle Meter with Magnet



7851-M/8951-M

mm		mm		Icons	
1/2 in	0-360	490 mm		1	7851-M
3/4 in	0-360	490 mm		1	8951-M

Angle Meter with Clamp



7851-G

mm		mm		Icons	
1/2 in	0-360	555 mm		1	7851-G

INSERT TOOLS

Round Ratchet Head with Rectangular Connector





9/14/24/27R

mm		max		Icons	
1/4 in	9x12 mm	30 N·m		1	9R-1/4
3/8 in	9x12 mm	135 N·m		1	9R-3/8
1/2 in	9x12 mm	160 N·m		1	9R-1/2
1/2 in	14x18 mm	340 N·m		1	14R-1/2
3/4 in	14x18 mm	420 N·m		1	14R-3/4
3/4 in	24x32 mm	1000 N·m		1	24R-3/4
1 in	24x32 mm	1200 N·m		1	24R-1
1 in	27x36 mm	2500 N·m		1	27R-1







Push-Through Square Ratchet Head with Rectangular Connector



					
1/2 in		9x12 mm	160 N·m	1	9P-1/2
1/2 in		14x18 mm	340 N·m	1	14P-1/2





9/14/24/27T

					
1/4 in		9x12 mm	30 N·m	1	9T-1/4
3/8 in		9x12 mm	135 N·m	1	9T-3/8
1/2 in		9x12 mm	160 N·m	1	9T-1/2
1/2 in		14x18 mm	340 N·m	1	14T-1/2
3/4 in		14x18 mm	420 N·m	1	14T-3/4
3/4 in		24x32 mm	1000 N·m	1	24T-3/4
1 in		24x32 mm	1200 N·m	1	24T-1
1 in		27x36 mm	2500 N·m	1	27T-1

Fixed Square Head with Rectangular Connector





9/14/24/27F

					
1/4 in		9x12 mm	30 N·m	1	9F-1/4
3/8 in		9x12 mm	135 N·m	1	9F-3/8
1/2 in		9x12 mm	160 N·m	1	9F-1/2
1/2 in		14x18 mm	340 N·m	1	14F-1/2
3/4 in		14x18 mm	420 N·m	1	14F-3/4
3/4 in		24x32 mm	1000 N·m	1	24F-3/4
1 in		24x32 mm	1200 N·m	1	24F-1
1 in		27x36 mm	2500 N·m	1	27F-1

Pear Ratchet Head with Rectangular Connector







9/14P

					
1/4 in		9x12 mm	30 N·m	1	9P-1/4
3/8 in		9x12 mm	135 N·m	1	9P-3/8

Pear Ratchet Head with Quick-Release and Rectangular Connector







9/14Q

					
1/4 in		9x12 mm	30 N·m	1	9Q-1/4
3/8 in		9x12 mm	135 N·m	1	9Q-3/8
1/2 in		9x12 mm	160 N·m	1	9Q-1/2
1/2 in		14x18 mm	340 N·m	1	14Q-1/2

Ratchet Head for Screwdriver Bits with Rectangular Connector







9B





				
1/4 in		9x12 mm	1	9B-1/4
5/16 in		9x12 mm	1	9B-5/16

Open-End Metric Wrench with Rectangular Connector



9/14/24/277

				
7 mm	9x12 mm	9 N·m	1	97-7
8 mm	9x12 mm	13 N·m	1	97-8
9 mm	9x12 mm	18 N·m	1	97-9
10 mm	9x12 mm	24 N·m	1	97-10
11 mm	9x12 mm	32 N·m	1	97-11
12 mm	9x12 mm	41 N·m	1	97-12
13 mm	9x12 mm	51 N·m	1	97-13
14 mm	9x12 mm	63 N·m	1	97-14
15 mm	9x12 mm	77 N·m	1	97-15
16 mm	9x12 mm	92 N·m	1	97-16
17 mm	9x12 mm	109 N·m	1	97-17
18 mm	9x12 mm	125 N·m	1	97-18
19 mm	9x12 mm	145 N·m	1	97-19
21 mm	9x12 mm	160 N·m	1	97-21
22 mm	9x12 mm	160 N·m	1	97-22
24 mm	9x12 mm	160 N·m	1	97-24
27 mm	9x12 mm	160 N·m	1	97-27
30 mm	9x12 mm	160 N·m	1	97-30
32 mm	9x12 mm	160 N·m	1	97-32
13 mm	14x18 mm	51 N·m	1	147-13
14 mm	14x18 mm	63 N·m	1	147-14
15 mm	14x18 mm	77 N·m	1	147-15
16 mm	14x18 mm	92 N·m	1	147-16
17 mm	14x18 mm	109 N·m	1	147-17
18 mm	14x18 mm	125 N·m	1	147-18
19 mm	14x18 mm	145 N·m	1	147-19
21 mm	14x18 mm	190 N·m	1	147-21
22 mm	14x18 mm	220 N·m	1	147-22
24 mm	14x18 mm	280 N·m	1	147-24
25 mm	14x18 mm	320 N·m	1	147-25
27 mm	14x18 mm	360 N·m	1	147-27
30 mm	14x18 mm	360 N·m	1	147-30
32 mm	14x18 mm	360 N·m	1	147-32
33 mm	14x18 mm	360 N·m	1	147-33
34 mm	14x18 mm	360 N·m	1	147-34
35 mm	14x18 mm	360 N·m	1	147-35
36 mm	14x18 mm	360 N·m	1	147-36
37 mm	14x18 mm	360 N·m	1	147-37
38 mm	14x18 mm	360 N·m	1	147-38
39 mm	14x18 mm	360 N·m	1	147-39
41 mm	14x18 mm	360 N·m	1	147-41
45 mm	14x18 mm	360 N·m	1	147-45
46 mm	14x18 mm	360 N·m	1	147-46
50 mm	14x18 mm	360 N·m	1	147-50
55 mm	14x18 mm	360 N·m	1	147-55
60 mm	14x18 mm	360 N·m	1	147-60
65 mm	14x18 mm	360 N·m	1	147-65
68 mm	14x18 mm	360 N·m	1	147-68
70 mm	14x18 mm	360 N·m	1	147-70
75 mm	14x18 mm	360 N·m	1	147-75
90 mm	14x18 mm	360 N·m	1	147-90
24 mm	24x32 mm	1200 N·m	1	247-24
27 mm	24x32 mm	1200 N·m	1	247-27

				
30 mm	24x32 mm	1200 N·m	1	247-30
32 mm	24x32 mm	1200 N·m	1	247-32
34 mm	24x32 mm	1200 N·m	1	247-34
36 mm	24x32 mm	1200 N·m	1	247-36
41 mm	24x32 mm	1200 N·m	1	247-41
46 mm	24x32 mm	1200 N·m	1	247-46
50 mm	24x32 mm	1200 N·m	1	247-50
55 mm	24x32 mm	1200 N·m	1	247-55
60 mm	24x32 mm	1200 N·m	1	247-60
30 mm	27x36 mm	3000 N·m	1	277-30
32 mm	27x36 mm	3000 N·m	1	277-32
34 mm	27x36 mm	3000 N·m	1	277-34
36 mm	27x36 mm	3000 N·m	1	277-36
41 mm	27x36 mm	3000 N·m	1	277-41
46 mm	27x36 mm	3000 N·m	1	277-46
50 mm	27x36 mm	3000 N·m	1	277-50
55 mm	27x36 mm	3000 N·m	1	277-55
60 mm	27x36 mm	3000 N·m	1	277-60

Open-End Imperial Wrench with Rectangular Connector



9/14/24/277"





				
1/4 in	9x12 mm	6 N·m	1	97-1/4
5/16 in	9x12 mm	13 N·m	1	97-5/16
3/8 in	9x12 mm	24 N·m	1	97-3/8
7/16 in	9x12 mm	32 N·m	1	97-7/16
1/2 in	9x12 mm	51 N·m	1	97-1/2
17/32 in	9x12 mm	63 N·m	1	97-17/32
9/16 in	9x12 mm	77 N·m	1	97-9/16
5/8 in	9x12 mm	92 N·m	1	97-5/8
11/16 in	9x12 mm	125 N·m	1	97-11/16
3/4 in	9x12 mm	145 N·m	1	97-3/4
13/16 in	9x12 mm	160 N·m	1	97-13/16
7/8 in	9x12 mm	160 N·m	1	97-7/8
15/16 in	9x12 mm	160 N·m	1	97-15/16
1 in	9x12 mm	160 N·m	1	97-1
7/16 in	14x18 mm	32 N·m	1	147-7/16
1/2 in	14x18 mm	51 N·m	1	147-1/2
9/16 in	14x18 mm	77 N·m	1	147-9/16
5/8 in	14x18 mm	92 N·m	1	147-5/8
11/16 in	14x18 mm	109 N·m	1	147-11/16
3/4 in	14x18 mm	145 N·m	1	147-3/4
13/16 in	14x18 mm	190 N·m	1	147-13/16
7/8 in	14x18 mm	220 N·m	1	147-7/8
15/16 in	14x18 mm	280 N·m	1	147-15/16
1 in	14x18 mm	360 N·m	1	147-1
1 1/8 in	14x18 mm	360 N·m	1	147-1.1/8
1 1/4 in	14x18 mm	360 N·m	1	147-1.1/4







Ring End Metric Wrench with Rectangular Connector



9/14/24/278





				
7 mm	9x12 mm	25 N·m	1	98-7
8 mm	9x12 mm	34 N·m	1	98-8
9 mm	9x12 mm	45 N·m	1	98-9
10 mm	9x12 mm	58 N·m	1	98-10
11 mm	9x12 mm	47 N·m	1	98-11
12 mm	9x12 mm	89 N·m	1	98-12
13 mm	9x12 mm	105 N·m	1	98-13
14 mm	9x12 mm	125 N·m	1	98-14
15 mm	9x12 mm	145 N·m	1	98-15
16 mm	9x12 mm	160 N·m	1	98-16
17 mm	9x12 mm	160 N·m	1	98-17
18 mm	9x12 mm	160 N·m	1	98-18
19 mm	9x12 mm	160 N·m	1	98-19
21 mm	9x12 mm	160 N·m	1	98-21
22 mm	9x12 mm	160 N·m	1	98-22
13 mm	14x18 mm	105 N·m	1	148-13
14 mm	14x18 mm	125 N·m	1	148-14
15 mm	14x18 mm	150 N·m	1	148-15
16 mm	14x18 mm	175 N·m	1	148-16
17 mm	14x18 mm	200 N·m	1	148-17
18 mm	14x18 mm	230 N·m	1	148-18
19 mm	14x18 mm	260 N·m	1	148-19
21 mm	14x18 mm	330 N·m	1	148-21
22 mm	14x18 mm	360 N·m	1	148-22
24 mm	14x18 mm	360 N·m	1	148-24
27 mm	14x18 mm	360 N·m	1	148-27
28 mm	14x18 mm	360 N·m	1	148-28
30 mm	14x18 mm	360 N·m	1	148-30
32 mm	14x18 mm	360 N·m	1	148-32
34 mm	14x18 mm	360 N·m	1	148-34
36 mm	14x18 mm	360 N·m	1	148-36
41 mm	14x18 mm	360 N·m	1	148-41
24 mm	24x32 mm	1200 N·m	1	248-24
27 mm	24x32 mm	1200 N·m	1	248-27
30 mm	24x32 mm	1200 N·m	1	248-30
32 mm	24x32 mm	1200 N·m	1	248-32
34 mm	24x32 mm	1200 N·m	1	248-34
36 mm	24x32 mm	1200 N·m	1	248-36
41 mm	24x32 mm	1200 N·m	1	248-41
46 mm	24x32 mm	1200 N·m	1	248-46
50 mm	24x32 mm	1200 N·m	1	248-50
55 mm	24x32 mm	1200 N·m	1	248-55
60 mm	24x32 mm	1200 N·m	1	248-60
30 mm	27x36 mm	3000 N·m	1	278-30
32 mm	27x36 mm	1240 N·m	1	278-32
34 mm	27x36 mm	3000 N·m	1	278-34
36 mm	27x36 mm	3000 N·m	1	278-36
41 mm	27x36 mm	3000 N·m	1	278-41

				
46 mm	27x36 mm	3000 N·m	1	278-46
50 mm	27x36 mm	3000 N·m	1	278-50
55 mm	27x36 mm	3000 N·m	1	278-55
60 mm	27x36 mm	3000 N·m	1	278-60

Ring End Imperial Wrench with Rectangular Connector







9/14/24/278"





				
1/4 in	9x12 mm	25 N·m	1	98-1/4
5/16 in	9x12 mm	34 N·m	1	98-5/16
3/8 in	9x12 mm	58 N·m	1	98-3/8
7/16 in	9x12 mm	72 N·m	1	98-7/16
1/2 in	9x12 mm	105 N·m	1	98-1/2
9/16 in	9x12 mm	125 N·m	1	98-9/16
5/8 in	9x12 mm	160 N·m	1	98-5/8
11/16 in	9x12 mm	160 N·m	1	98-11/16
3/4 in	9x12 mm	57 N·m	1	98-3/4
13/16 in	14x18 mm	330 N·m	1	148-13/16
13/16 in	9x12 mm	160 N·m	1	98-13/16
7/8 in	9x12 mm	160 N·m	1	98-7/8
1/2 in	14x18 mm	105 N·m	1	148-1/2
9/16 in	14x18 mm	150 N·m	1	148-9/16
5/8 in	14x18 mm	175 N·m	1	148-5/8
11/16 in	14x18 mm	230 N·m	1	148-11/16
3/4 in	14x18 mm	260 N·m	1	148-3/4
15/16 in	14x18 mm	360 N·m	1	148-15/16
7/8 in	14x18 mm	360 N·m	1	148-7/8
1 in	14x18 mm	360 N·m	1	148-1

Flare Nut End Wrench with Rectangular Connector



99 in





				
3/8 in	9x12 mm	9 N·m	1	99-3/8
7/16 in	9x12 mm	16 N·m	1	99-7/16
1/2 in	9x12 mm	28 N·m	1	99-1/2

				
	mm			
9/16 in	9x12 mm	31 N·m	1	99-9/16
5/8 in	9x12 mm	46 N·m	1	99-5/8
11/16 in	9x12 mm	65 N·m	1	99-11/16
3/4 in	9x12 mm	74 N·m	1	99-3/4

Flare Nut End Wrench with Rectangular Connector







99

				
	mm			
10 mm	9x12 mm	14 N·m	1	99-10
11 mm	9x12 mm	19 N·m	1	99-11
12 mm	9x12 mm	24 N·m	1	99-12
13 mm	9x12 mm	30 N·m	1	99-13
14 mm	9x12 mm	37 N·m	1	99-14
16 mm	9x12 mm	46 N·m	1	99-16
17 mm	9x12 mm	55 N·m	1	99-17
18 mm	9x12 mm	65 N·m	1	99-18
19 mm	9x12 mm	74 N·m	1	99-19
21 mm	9x12 mm	87 N·m	1	99-21
22 mm	9x12 mm	96 N·m	1	99-22
24 mm	9x12 mm	96 N·m	1	99-24

Increasing and Reducing Rectangular Connector Adaptors







9/14/24/27A

				
mm	mm			
9x12 mm	14x18 mm	160 N·m	1	9A-14
14x18 mm	9x12 mm	160 N·m	1	14A-9
14x18 mm	24x32 mm	360 N·m	1	14A-32
24x32 mm	14x18 mm	360 N·m	1	24A-14
24x32 mm	27x36 mm	1200 N·m	1	24A-27
27x36 mm	24x32 mm	1200 N·m	1	27A-24

Weld-On Adaptor with Rectangular Connector







9/14/24W

			
mm	L		
9x12 mm	23.8 mm	1	9W
14x18 mm	38 mm	1	14W
24x32 mm	65 mm	1	24W

Round Ratchet Head with Spigot Connector







16R/22R

				
	mm			
1/4" in	16 mm	20 N·m	1	16R-1/4
3/8" in	16 mm	160 N·m	1	16R-3/8
1/2" in	16 mm	420 N·m	1	16R-1/2
3/4" in	22 mm	1200 N·m	1	22R-3/4

Fixed Square Head with Spigot Connector



16F/22F





				
	mm			
1/4" in	16 mm	20 N·m	1	16F-1/4
3/8" in	16 mm	160 N·m	1	16F-3/8
1/2" in	16 mm	420 N·m	1	16F-1/2
3/4" in	22 mm	1200 N·m	1	22F-3/4



Open End Metric Wrench with Spigot Connector







167/227

				
mm	mm			
7 mm	16 mm	9 N·m	1	167-7
8 mm	16 mm	13 N·m	1	167-8
9 mm	16 mm	18 N·m	1	167-9
10 mm	16 mm	24 N·m	1	167-10
11 mm	16 mm	32 N·m	1	167-11
12 mm	16 mm	41 N·m	1	167-12
13 mm	16 mm	51 N·m	1	167-13
14 mm	16 mm	63 N·m	1	167-14
15 mm	16 mm	77 N·m	1	167-15
16 mm	16 mm	92 N·m	1	167-16
17 mm	16 mm	109 N·m	1	167-17
18 mm	16 mm	125 N·m	1	167-18
19 mm	16 mm	145 N·m	1	167-19
20 mm	16 mm	160 N·m	1	167-20
21 mm	16 mm	190 N·m	1	167-21
22 mm	16 mm	220 N·m	1	167-22
23 mm	16 mm	250 N·m	1	167-23
24 mm	16 mm	280 N·m	1	167-24
25 mm	16 mm	320 N·m	1	167-25
26 mm	16 mm	360 N·m	1	167-26
27 mm	16 mm	360 N·m	1	167-27
28 mm	16 mm	360 N·m	1	167-28
30 mm	16 mm	360 N·m	1	167-30
32 mm	16 mm	360 N·m	1	167-32
36 mm	16 mm	360 N·m	1	167-36
22 mm	22 mm	1200 N·m	1	227-22
24 mm	22 mm	1200 N·m	1	227-24
27 mm	22 mm	1200 N·m	1	227-27
30 mm	22 mm	1200 N·m	1	227-30
32 mm	22 mm	1200 N·m	1	227-32
34 mm	22 mm	1200 N·m	1	227-34
36 mm	22 mm	1200 N·m	1	227-36
41 mm	22 mm	1200 N·m	1	227-41
46 mm	22 mm	1200 N·m	1	227-46

Open-End Imperial Wrench with Spigot Connector







167





				
	mm			
5/16 in	16 mm	34 N·m	1	167-5/16
3/8 in	16 mm	45 N·m	1	167-3/8
7/16 in	16 mm	72 N·m	1	167-7/16
1/2 in	16 mm	51 N·m	1	167-1/2
9/16 in	16 mm	77 N·m	1	167-9/16
5/8 in	16 mm	92 N·m	1	167-5/8
11/16 in	16 mm	109 N·m	1	167-11/16
3/4 in	16 mm	145 N·m	1	167-3/4
13/16 in	16 mm	190 N·m	1	167-13/16
7/8 in	16 mm	220 N·m	1	167-7/8
15/16 in	16 mm	280 N·m	1	167-15/16
1 in	16 mm	360 N·m	1	167-1
1.1/16 in	16 mm	360 N·m	1	167-1.1/16
1.1/8 in	16 mm	360 N·m	1	167-1.1/8
1.3/16 in	16 mm	360 N·m	1	167-1.3/16
1.1/4 in	16 mm	360 N·m	1	167-1.1/4

Ring End Metric Wrench with Spigot Connector



168/228





				
	mm			
7 mm	16 mm	25 N·m	1	168-7
8 mm	16 mm	34 N·m	1	168-8
9 mm	16 mm	45 N·m	1	168-9
10 mm	16 mm	58 N·m	1	168-10
11 mm	16 mm	72 N·m	1	168-11
12 mm	16 mm	89 N·m	1	168-12

 mm	 mm	 N·m	 
13 mm	16 mm	105 N·m	1 168-13
14 mm	16 mm	125 N·m	1 168-14
15 mm	16 mm	150 N·m	1 168-15
16 mm	16 mm	175 N·m	1 168-16
17 mm	16 mm	200 N·m	1 168-17
18 mm	16 mm	230 N·m	1 168-18
19 mm	16 mm	260 N·m	1 168-19
20 mm	16 mm	290 N·m	1 168-20
21 mm	16 mm	330 N·m	1 168-21
22 mm	16 mm	360 N·m	1 168-22
23 mm	16 mm	360 N·m	1 168-23
24 mm	16 mm	360 N·m	1 168-24
26 mm	16 mm	360 N·m	1 168-26
27 mm	16 mm	360 N·m	1 168-27
22 mm	22 mm	1200 N·m	1 228-22
24 mm	22 mm	1200 N·m	1 228-24
27 mm	22 mm	1200 N·m	1 228-27
30 mm	22 mm	1200 N·m	1 228-30
32 mm	22 mm	1200 N·m	1 228-32
34 mm	22 mm	1200 N·m	1 228-34
36 mm	22 mm	1200 N·m	1 228-36
41 mm	22 mm	1200 N·m	1 228-41
46 mm	22 mm	1200 N·m	1 228-46

Ring End Imperial Wrench with Spigot Connector







168

 in	 mm	 N·m	 
5/16 in	16 mm	34 N·m	1 168-5/16
3/8 in	16 mm	58 N·m	1 168-3/8
7/16 in	16 mm	89 N·m	1 168-7/16
1/2 in	16 mm	105 N·m	1 168-1/2
9/16 in	16 mm	125 N·m	1 168-9/16
5/8 in	16 mm	125 N·m	1 168-5/8
11/16 in	16 mm	125 N·m	1 168-11/16
3/4 in	16 mm	260 N·m	1 168-3/4
13/16 in	16 mm	290 N·m	1 168-13/16
7/8 in	16 mm	360 N·m	1 168-7/8
15/16 in	16 mm	360 N·m	1 168-15/16
1 in	16 mm	360 N·m	1 168-1
1.1/16 in	16 mm	360 N·m	1 168-1.1/16
1.3/16 in	16 mm	360 N·m	1 168-1.3/16

Flare Nut End Metric Wrench with Spigot Connector



169

 mm	 mm	 N·m	 
7 mm	16 mm	6 N·m	1 169-7
8 mm	16 mm	8 N·m	1 169-8
9 mm	16 mm	10 N·m	1 169-9
10 mm	16 mm	12 N·m	1 169-10
11 mm	16 mm	16 N·m	1 169-11
12 mm	16 mm	16 N·m	1 169-12
13 mm	16 mm	28 N·m	1 169-13
14 mm	16 mm	31 N·m	1 169-14
15 mm	16 mm	38 N·m	1 169-15
16 mm	16 mm	46 N·m	1 169-16
17 mm	16 mm	53 N·m	1 169-17
18 mm	16 mm	65 N·m	1 169-18
19 mm	16 mm	74 N·m	1 169-19
20 mm	16 mm	86 N·m	1 169-20
21 mm	16 mm	100 N·m	1 169-21
22 mm	16 mm	115 N·m	1 169-22
23 mm	16 mm	125 N·m	1 169-23
24 mm	16 mm	145 N·m	1 169-24
27 mm	16 mm	160 N·m	1 169-27

EMPTY SET CASES FOR TORQUE TOOLS

Double Wall Shock Absorbing Empty Cases for Torque Tools



4750BMCT

	 
0.95 kg	1 4750BMCT1





BAHCO



Power Tool Accessories



HOLESAWS

Sandflex® Bi-Metal Holesaws for Metal/
Wood Boards 14 mm-210 mm



3830

Icon	Icon		
		14 mm	1 3830-14-C
		16 mm	1 3830-16-C
		17 mm	1 3830-17-C
		19 mm	1 3830-19-C
		20 mm	1 3830-20-C
		21 mm	1 3830-21-C
		22 mm	1 3830-22-C
		24 mm	1 3830-24-C
		25 mm	1 3830-25-C
		27 mm	1 3830-27-C
		29 mm	1 3830-29-C
		30 mm	1 3830-30-C
		32 mm	1 3830-32-C
		33 mm	1 3830-33-C
		35 mm	1 3830-35-C
		37 mm	1 3830-37-C
		38 mm	1 3830-38-C
		40 mm	1 3830-40-C
		41 mm	1 3830-41-C
		43 mm	1 3830-43-C
		44 mm	1 3830-44-C
		46 mm	1 3830-46-C
		48 mm	1 3830-48-C
		50 mm	1 3830-50-C
		51 mm	1 3830-51-C
		52 mm	1 3830-52-C
		54 mm	1 3830-54-C
		55 mm	1 3830-55-C
		56 mm	1 3830-56-C
		57 mm	1 3830-57-C
		59 mm	1 3830-59-C
		60 mm	1 3830-60-C
		64 mm	1 3830-64-C
		65 mm	1 3830-65-C
		67 mm	1 3830-67-C
		68 mm	1 3830-68-C
		70 mm	1 3830-70-C
		73 mm	1 3830-73-C
		76 mm	1 3830-76-C
		79 mm	1 3830-79-C
		83 mm	1 3830-83-C
		86 mm	1 3830-86-C
		89 mm	1 3830-89-C
		92 mm	1 3830-92-C
		95 mm	1 3830-95-C
		98 mm	1 3830-98-C
		102 mm	1 3830-102-C
		105 mm	1 3830-105-C
		108 mm	1 3830-108-C

Icon	Icon		
		111 mm	1 3830-111-C
		114 mm	1 3830-114-C
		121 mm	1 3830-121-C
		127 mm	1 3830-127-C
		133 mm	1 3830-133-C
		140 mm	1 3830-140-C
		146 mm	1 3830-146-C
		152 mm	1 3830-152-C
		14 mm	6 3830-14-VIP
		16 mm	6 3830-16-VIP
		17 mm	6 3830-17-VIP
		19 mm	6 3830-19-VIP
		20 mm	6 3830-20-VIP
		21 mm	6 3830-21-VIP
		22 mm	6 3830-22-VIP
		24 mm	6 3830-24-VIP
		25 mm	6 3830-25-VIP
		27 mm	6 3830-27-VIP
		29 mm	6 3830-29-VIP
		30 mm	6 3830-30-VIP
		32 mm	6 3830-32-VIP
		33 mm	6 3830-33-VIP
		35 mm	6 3830-35-VIP
		37 mm	6 3830-37-VIP
		38 mm	6 3830-38-VIP
		40 mm	6 3830-40-VIP
		41 mm	6 3830-41-VIP
		43 mm	6 3830-43-VIP
		44 mm	6 3830-44-VIP
		46 mm	6 3830-46-VIP
		48 mm	6 3830-48-VIP
		50 mm	6 3830-50-VIP
		51 mm	6 3830-51-VIP
		52 mm	4 3830-52-VIP
		54 mm	4 3830-54-VIP
		55 mm	4 3830-55-VIP
		56 mm	4 3830-56-VIP
		57 mm	4 3830-57-VIP
		59 mm	4 3830-59-VIP
		60 mm	4 3830-60-VIP
		62 mm	4 3830-62-VIP
		64 mm	4 3830-64-VIP
		65 mm	4 3830-65-VIP
		67 mm	4 3830-67-VIP
		68 mm	4 3830-68-VIP
		70 mm	4 3830-70-VIP
		73 mm	4 3830-73-VIP
		76 mm	4 3830-76-VIP
		79 mm	4 3830-79-VIP
		83 mm	4 3830-83-VIP
		86 mm	4 3830-86-VIP
		89 mm	4 3830-89-VIP
		92 mm	4 3830-92-VIP
		95 mm	4 3830-95-VIP
		98 mm	4 3830-98-VIP
		102 mm	4 3830-102-VIP
		105 mm	4 3830-105-VIP
		108 mm	4 3830-108-VIP
		111 mm	4 3830-111-VIP
		114 mm	4 3830-114-VIP
		121 mm	1 3830-121-VIP
		127 mm	1 3830-127-VIP
		133 mm	1 3830-133-VIP
		140 mm	1 3830-140-VIP
		146 mm	1 3830-146-VIP
		152 mm	1 3830-152-VIP
		168 mm	1 3830-168
		177 mm	1 3830-177-HIGH
		210 mm	1 3830-210

Sandflex® Bi-Metal Holesaws, 4 pack



3830-4P

Icon	Icon	Icon	Icon		
				4	19 mm
				4	20 mm
				4	22 mm
				4	25 mm
				4	27 mm
				4	29 mm
				4	30 mm
				4	32 mm
				4	35 mm

Sandflex® Bi-Metal Holesaw Set 20x4 mm + 25x4 mm - 11 pcs



3834-CP-20/25

Icon	Icon		
		600 g	1 3834-CP-20/25

3830-20-Cx 4, 3830-25-Cx 4

3834-ARBR-930

3834-DRLx 2



Sandflex® Bi-Metal Holesaw Set 20–76 mm - 10 pcs



3834-PROMO-82

1188 g	1	3834-PROMO-82

- 3830-20-C, 3830-25-C, 3830-30-C, 3830-35-C, 3830-44-C, 3830-51-C, 3830-64-C, 3830-76-C
- 3834-ARBR-930
- 3834-ARBR-11152QC

Sandflex® Bi-Metal Holesaw Set 19–76 mm - 14 pcs



3834-PROMO-122-76

1441 g	1	3834-PROMO-122-76

- 3830-19-C, 3830-20-C, 3830-22-C, 3830-25-C, 3830-27-C, 3830-32-C, 3830-35-C, 3830-38-C, 3830-40-C, 3830-51-C, 3830-64-C, 3830-76-C
- 3834-ARBR-930
- 3834-ARBR-9100

Sandflex® Bi-Metal Holesaw Set 51 mm-111 mm - 6 Pcs



3834-42

2025 g	1	3834-SET-42

- 3830-51-VIP, 3830-76-VIP, 3830-86-VIP, 3830-111-VIP
- 3834-ARBR-9100
- 3834-ES

Sandflex® Bi-Metal Holesaw Set 16–44 mm - 14 pcs



3834-PROMO-122

1100 g	1	3834-PROMO-122

- 3830-16-C, 3830-20-Cx 2, 3830-22-C, 3830-25-Cx 2, 3830-29-C, 3830-32-C, 3830-35-Cx 2, 3830-38-C, 3830-44-C
- 3834-ARBR-930
- 3834-ARBR-11152QC

Sandflex® Bi-Metal Holesaw Set 35–83 mm - 9 pcs



3834-SET-72-35/83

1613 g	1	3834-SET-72-35/83

- 3830-35-C, 3830-40-C, 3830-44-C, 3830-51-C, 3830-57-C, 3830-68-C, 3830-83-C
- 3834-ARBR-9100
- 3834-DRL

Sandflex® Bi-Metal Holesaw Set 19 mm-79 mm - 13 Pcs



3834-53

2370 g	1	3834-SET-53

- 3830-19-VIP, 3830-22-VIP, 3830-25-VIP, 3830-29-VIP, 3830-30-VIP, 3830-35-VIP, 3830-37-VIP, 3830-41-VIP, 3830-52-VIP, 3830-60-VIP, 3830-79-VIP
- 3834-ARBR-930
- 3834-ARBR-9100



Sandflex® Bi-Metal Holesaw Set 51 mm-114 mm - 7 Pcs



3834-61

3145 g	1	3834-SET-61

3830-44-VIP, 3830-51-VIP, 3830-57-VIP, 3830-73-VIP, 3830-86-VIP, 3830-114-VIP	
3834-ARBR-9100	

Sandflex® Bi-Metal Holesaw Set for Metal/Wood Boards 16 mm-50 mm - 8 Pcs



3834-62-16/50

1065 g	1	3834-SET-62-16/50

3830-16-VIP, 3830-20-VIP, 3830-25-VIP, 3830-32-VIP, 3830-40-VIP, 3830-50-VIP	
3834-ARBR-9100	
3834-ARBR-930	

Sandflex® Bi-Metal Holesaw Set for Metal/Wood Boards 22 mm-64 mm - 9 Pcs



3834-65-22/64

1625 g	1	3834-SET-65-22/64

3830-22-VIP, 3830-29-VIP, 3830-35-VIP, 3830-44-VIP, 3830-51-VIP, 3830-64-VIP	
3834-ARBR-1130	
3834-ARBR-11152	
3834-DRL	

Sandflex® Bi-Metal Holesaw Set 19 mm-48 mm - 8 Pcs



3834-62

1050 g	1	3834-SET-62

3830-19-VIP, 3830-21-VIP, 3830-22-VIP, 3830-29-VIP, 3830-38-VIP, 3830-48-VIP	
3834-ARBR-930	
3834-ARBR-9100	

Sandflex® Bi-Metal Holesaw Set for Metal/Wood Boards 16 mm-51 mm - 9 Pcs



3834-65-16/51

1465 g	1	3834-SET-65-16/51

3830-16-VIP, 3830-20-VIP, 3830-25-VIP, 3830-32-VIP, 3830-40-VIP, 3830-51-VIP	
3834-ARBR-1130	
3834-ARBR-11152	
3834-DRL	

Sandflex® Bi-Metal Holesaw Set 19 mm-64 mm - 9 Pcs



3834-72

1080 g	1	3834-SET-72

3830-19-VIP, 3830-22-VIP, 3830-29-VIP, 3830-35-VIP, 3830-44-VIP, 3830-51-VIP, 3830-64-VIP	
3834-ARBR-930	
3834-ARBR-9100	

Sandflex® Bi-Metal Holesaw Set 16 mm-92 mm - 9 Pcs



3834-73

g 2080 g 1 3834-SET-73

- 3830-16-VIP, 3830-22-VIP, 3830-51-VIP, 3830-57-VIP, 3830-73-VIP, 3830-76-VIP, 3830-92-VIP
- 3834-ARBR-930
- 3834-ARBR-9100

Sandflex® Bi-Metal Holesaw Set 22 mm-68 mm - 10 Pcs



3834-73-22/68

g 2170 g 1 3834-SET-73-22/68

- 3830-22-VIP, 3830-29-VIP, 3830-35-VIP, 3830-44-VIP, 3830-51-VIP, 3830-64-VIP, 3830-68-VIP
- 3834-ARBR-1130
- 3834-ARBR-11152
- 3834-DRL

Sandflex® Bi-Metal Holesaw Set 16 mm-86 mm - 13 Pcs



3834-SET-77

g 3325 g 1 3834-SET-77

- 3830-16-VIP, 3830-20-VIP, 3830-25-VIP, 3830-32-VIP, 3830-41-VIP, 3830-51-VIP, 3830-73-VIP, 3830-76-VIP, 3830-83-VIP, 3830-86-VIP
- 3834-ARBR-930
- 3834-ARBR-9100
- 3834-DRL

Sandflex® Bi-Metal Holesaw Set 25-114 mm - 12 pcs



3834-SET-84-ES

g 3600 g 1 3834-SET-84-ES

- 3830-25-C, 3830-30-C, 3830-35-C, 3830-51-C, 3830-54-C, 3830-76-C, 3830-92-C, 3830-114-C
- 3834-ARBR-930ESM, 3834-ARBR-9100ESM
- 3834-DRL-HSS-ES
- 3834-UPSIZE

Sandflex® Bi-Metal Holesaw Set 25 mm-114 mm - 12 Pcs



3834-86

g 2540 g 1 3834-SET-86

- 3830-25-VIP, 3830-32-VIP, 3830-35-VIP, 3830-51-VIP, 3830-54-VIP, 3830-76-VIP, 3830-92-VIP, 3830-114-VIP
- 3834-ARBR-1130
- 3834-ARBR-11152
- 3834-DRLx 2
- 3834-ADP

Sandflex® Bi-Metal Holesaw Set 19 mm-65 mm - 12 Pcs



3834-87

g 1925 g 1 3834-SET-87

- 3830-19-VIP, 3830-22-VIP, 3830-29-VIP, 3830-38-VIP, 3830-43-VIP, 3830-48-VIP, 3830-52-VIP, 3830-65-VIP
- 3834-ARBR-930
- 3834-ARBR-9100
- 3834-DRL
- 3834-ES



Sandflex® Bi-Metal Holesaw Set for Metal/
Wood Boards 16 mm-83 mm - 11 Pcs



3834-92



1440 g



1 3834-SET-92

3830-16-VIP, 3830-22-VIP, 3830-25-VIP, 3830-29-VIP, 3830-32-VIP, 3830-41-VIP, 3830-51-VIP, 3830-73-VIP, 3830-83-VIP



3834-ARBR-930



3834-ARBR-9100



Sandflex® Bi-Metal Holesaw Set for Metal/
Wood Boards 16 mm-67 mm - 11 Pcs



3834-94



1815 g



1 3834-SET-94

3830-16-VIP, 3830-19-VIP, 3830-22-VIP, 3830-25-VIP, 3830-30-VIP, 3830-35-VIP, 3830-41-VIP, 3830-51-VIP, 3830-67-VIP



3834-ARBR-1130



3834-ARBR-11152



Sandflex® Bi-Metal Holesaw Set 16 mm-67
mm - 11 Pcs



3834-103



2015 g



1 3834-SET-103

3830-16-VIP, 3830-19-VIP, 3830-24-VIP, 3830-29-VIP, 3830-38-VIP, 3830-44-VIP, 3830-57-VIP, 3830-67-VIP



3834-ARBR-1130



3834-ARBR-11152



3834-DRL



Sandflex® Bi-Metal Holesaw Set 16-83
mm - 12 pcs



3834-93



2360 g



1 3834-SET-93

3830-16-VIP, 3830-20-VIP, 3830-25-VIP, 3830-32-VIP, 3830-40-VIP, 3830-51-VIP, 3830-67-VIP, 3830-76-VIP, 3830-83-VIP



3834-ARBR-930



3834-ARBR-9100QC



3834-DRL



Sandflex® Bi-Metal Holesaw Set for Metal/
Wood Boards 16 mm-64 mm - 12 Pcs



3834-95



1350 g



1 3834-SET-95

3830-16-VIP, 3830-19-VIP, 3830-22-VIP, 3830-29-VIP, 3830-35-VIP, 3830-44-VIP, 3830-52-VIP, 3830-57-VIP, 3830-64-VIP



3834-ARBR-1130



3834-ARBR-11152



3834-DRL



Sandflex® Bi-Metal Holesaw Set 16 mm-83
mm - 18 Pcs



3834-SET-152



3770 g



1 3834-SET-152

3830-16-VIP, 3830-19-VIP, 3830-22-VIP, 3830-25-VIP, 3830-32-VIP, 3830-35-VIP, 3830-44-VIP, 3830-51-VIP, 3830-57-VIP, 3830-60-VIP, 3830-65-VIP, 3830-68-VIP, 3830-73-VIP, 3830-76-VIP, 3830-83-VIP



3834-ARBR-930



3834-ARBR-9100



3834-DRLx 2



Superior™ Multi Construction Holesaws for Wood and Brick 19 mm-225 mm



3833

19 mm	1	3833-19-C	
20 mm	1	3833-20-C	
22 mm	1	3833-22-C	
25 mm	1	3833-25-C	
27 mm	1	3833-27-C	
29 mm	1	3833-29-C	
30 mm	1	3833-30-C	
32 mm	1	3833-32-C	
35 mm	1	3833-35-C	
38 mm	1	3833-38-C	
40 mm	1	3833-40-C	
41 mm	1	3833-41-C	
44 mm	1	3833-44-C	
48 mm	1	3833-48-C	
51 mm	1	3833-51-C	
54 mm	1	3833-54-C	
56 mm	1	3833-56-C	
57 mm	1	3833-57-C	
60 mm	1	3833-60-C	
62 mm	1	3833-62-C	
64 mm	1	3833-64-C	
65 mm	1	3833-65-C	
67 mm	1	3833-67-C	
68 mm	1	3833-68-C	
70 mm	1	3833-70-C	
71 mm	1	3833-71-C	
73 mm	1	3833-73-C	
74 mm	1	3833-74-C	
76 mm	1	3833-76-C	
77 mm	1	3833-77-C	
78 mm	1	3833-78-C	
79 mm	1	3833-79-C	
83 mm	1	3833-83-C	
86 mm	1	3833-86-C	
89 mm	1	3833-89-C	
92 mm	1	3833-92-C	
95 mm	1	3833-95-C	
98 mm	1	3833-98-C	
102 mm	1	3833-102-C	
105 mm	1	3833-105-C	
108 mm	1	3833-108-C	
109 mm	1	3833-109-C	
111 mm	1	3833-111-C	
114 mm	1	3833-114-C	
121 mm	1	3833-121-C	
127 mm	1	3833-127-C	
133 mm	1	3833-133-C	
140 mm	1	3833-140-C	
152 mm	1	3833-152-C	
159 mm	1	3833-159-C	
168 mm	1	3833-168	
177 mm	1	3833-177	
210 mm	1	3833-210	
225 mm	1	3833-225	

Superior™ Multi Construction Holesaw Set 32-83 mm - 6 pcs



3833-PROMO-42

1489 g	1	3833-PROMO-42

3833-32-C, 3833-51-C, 3833-76-C, 3833-83-C	
3834-ARBR-9100EL	
3834-UPSIZING	

Superior™ Multi Construction Holesaw Set 19 mm-64 mm - 10 Pcs



3833-SET-101

2.75 kg	1	3833-SET-101

3833-19-C, 3833-22-C, 3833-29-C, 3833-35-C, 3833-44-C, 3833-51-C, 3833-64-C	
3834-ARBR-930EL, 3834-ARBR-9100EL	
3834-DRL-EL	

Superior™ Multi Construction Holesaw Set 19 mm-86 mm - 14 Pcs



3833-SET-201

4.35 kg	1	3833-SET-201

3833-19-C, 3833-20-C, 3833-25-C, 3833-32-C, 3833-41-C, 3833-51-C, 3833-73-C, 3833-76-C, 3833-83-C, 3833-86-C	
3834-ARBR-930EL, 3834-ARBR-9100EL	
3834-DRL-EL	
3834-UPSIZING	

Superior™ Multi Construction Holesaw Set 19 mm-83 mm - 14 Pcs



3833-SET-202

4.1 kg	1	3833-SET-202

3833-19-C, 3833-20-C, 3833-25-C, 3833-32-C, 3833-41-C, 3833-51-C, 3833-57-C, 3833-60-C, 3833-73-C, 3833-83-C	
3834-ARBR-930EL, 3834-ARBR-9100EL	
3834-DRL-EL	
3834-UPSIZING	



Superior™ Multi Construction Holesaw Set
19 mm-78 mm - 14 Pcs



3833-SET-203



4.65 kg



1 3833-SET-203

3833-19-C, 3833-22-C, 3833-54-C, 3833-56-C,
3833-57-C, 3833-62-C, 3833-68-C, 3833-71-C,
3833-74-C, 3833-78-C

3834-ARBR-930EL, 3834-ARBR-9100EL

3834-DRL-EL

3834-UPSIZE

Superior™ Multi Construction Holesaw Set
22 mm-67 mm - 9 Pcs



3833-SET-205



2.81 kg



1 3833-SET-205

3833-22-C, 3833-35-C, 3833-44-C, 3833-51-C,
3833-67-C

3834-ARBR-930EL, 3834-ARBR-9100EL

3834-DRL-EL

3834-UPSIZE

Superior™ Multi Construction Holesaw Set
19 mm-76 mm - 15 Pcs



3833-SET-208



3.72 kg



1 3833-SET-208

3833-19-C, 3833-22-C, 3833-25-C, 3833-32-C,
3833-35-C, 3833-38-C, 3833-44-C, 3833-51-C,
3833-57-C, 3833-68-C, 3833-76-C

3834-ARBR-930EL, 3834-ARBR-9100EL

3834-DRL-EL

3834-UPSIZE

Superior™ Multi Construction Holesaw Set
32 mm-86 mm - 10 Pcs



3833-SET-204



3.88 kg



1 3833-SET-204

3833-32-C, 3833-41-C, 3833-51-C, 3833-73-C,
3833-76-C, 3833-83-C, 3833-86-C

3834-ARBR-9100EL

3834-DRL-EL

3834-UPSIZE

Superior™ Multi Construction Holesaw Set
19 mm-83 mm - 14 Pcs



3833-SET-207



3.90 kg



1 3833-SET-207

3833-19-C, 3833-22-C, 3833-25-C, 3833-35-C,
3833-44-C, 3833-51-C, 3833-64-C, 3833-67-C,
3833-76-C, 3833-83-C

3834-ARBR-930EL, 3834-ARBR-9100EL

3834-DRL-EL

3834-UPSIZE

Superior™ Multi Construction Holesaw Set
25 mm-114 mm - 12 Pcs



3833-SET-301



4.38 kg



1 3833-SET-301

3833-25-C, 3833-32-C, 3833-35-C, 3833-51-C,
3833-54-C, 3833-76-C, 3833-92-C, 3833-114-C

3834-ARBR-930EL, 3834-ARBR-9100EL

3834-DRL-EL

3834-UPSIZE

Superior™ Multi Construction Holesaw Set
51 mm-111 mm - 7 Pcs



3833-SET-302

3.51 kg	1	3833-SET-302

3833-51-C, 3833-76-C, 3833-86-C, 3833-111-C	
3834-ARBR-9100EL	
3834-DRL-EL	
3834-UPSIZ	

Superior™ Multi Construction Holesaw Set
35 mm-114 mm - 11 Pcs



3833-SET-303

4.17 kg	1	3833-SET-303

3833-35-C, 3833-40-C, 3833-51-C, 3833-57-C, 3833-60-C, 3833-74-C, 3833-83-C, 3833-105-C	
3834-ARBR-9100EL	
3834-DRL-EL	
3834-UPSIZ	

Superior™ Multi Construction Holesaw Set
19 mm-114 mm - 13 Pcs



3833-SET-304

4.20 kg	1	3833-SET-304

3833-19-C, 3833-25-C, 3833-32-C, 3833-35-C, 3833-51-C, 3833-54-C, 3833-76-C, 3833-92-C, 3833-114-C	
3834-ARBR-930EL, 3834-ARBR-9100EL	
3834-DRL-EL	
3834-UPSIZ	

Carbide Tipped Holesaws for Fibreglass/
Masonry 14 mm-152 mm



3832

14 mm	6	3832-14
16 mm	6	3832-16
17 mm	6	3832-17
19 mm	6	3832-19

20 mm	6	3832-20
21 mm	6	3832-21
22 mm	6	3832-22
24 mm	6	3832-24
25 mm	6	3832-25
27 mm	6	3832-27
29 mm	6	3832-29
30 mm	6	3832-30
32 mm	6	3832-32
33 mm	6	3832-33
35 mm	6	3832-35
37 mm	6	3832-37
38 mm	6	3832-38
40 mm	6	3832-40
41 mm	6	3832-41
43 mm	6	3832-43
44 mm	6	3832-44
46 mm	6	3832-46
48 mm	6	3832-48
51 mm	6	3832-51
52 mm	4	3832-52
54 mm	4	3832-54
56 mm	4	3832-56
57 mm	4	3832-57
59 mm	4	3832-59
60 mm	4	3832-60
64 mm	4	3832-64
65 mm	4	3832-65
67 mm	4	3832-67
68 mm	4	3832-68
70 mm	4	3832-70
73 mm	4	3832-73
76 mm	4	3832-76
79 mm	4	3832-79
83 mm	4	3832-83
86 mm	4	3832-86
89 mm	4	3832-89
92 mm	4	3832-92
95 mm	4	3832-95
98 mm	4	3832-98
102 mm	4	3832-102
105 mm	4	3832-105
108 mm	4	3832-108
111 mm	4	3832-111
114 mm	4	3832-114
121 mm	1	3832-121
127 mm	1	3832-127
133 mm	1	3832-133
140 mm	1	3832-140
146 mm	1	3832-146
152 mm	1	3832-152



Carbide Tipped Holesaws for Stainless Steel 16–127 mm



3832-C

Size (mm)	Quantity	Part Number
16 mm	1	3832-16-C
19 mm	1	3832-19-C
20 mm	1	3832-20-C
22 mm	1	3832-22-C
24 mm	1	3832-24-C
25 mm	1	3832-25-C
29 mm	1	3832-29-C
30 mm	1	3832-30-C
32 mm	1	3832-32-C
35 mm	1	3832-35-C
38 mm	1	3832-38-C
41 mm	1	3832-41-C
44 mm	1	3832-44-C
46 mm	1	3832-46-C
48 mm	1	3832-48-C
51 mm	1	3832-51-C
54 mm	1	3832-54-C
57 mm	1	3832-57-C
60 mm	1	3832-60-C
64 mm	1	3832-64-C
73 mm	1	3832-73-C
76 mm	1	3832-76-C
83 mm	1	3832-83-C
86 mm	1	3832-86-C
92 mm	1	3832-92-C
102 mm	1	3832-102-C
114 mm	1	3832-114-C
127 mm	1	3832-127-C

Carbide Tipped Holesaw Sets for Stainless Steel 25 mm -114 mm - 12 Pcs



3832-SET-84-ES

3600 g	1	3832-SET-84-ES
--------	---	----------------

3832-25-C, 3832-30-C, 3832-35-C, 3832-51-C, 3832-54-C, 3832-76-C, 3832-92-C, 3832-114-C	
3834-ARBR-9100ESM, 3834-ARBR-930ESM	
3834-DRL-HSS-ES	
3834-UPSIZING	

Carbide Tipped Holesaw Sets for Stainless Steel 16 mm-114 mm - 20 Pcs



3832-SET-164-ES

4800 g	1	3832-SET-164-ES
--------	---	-----------------

3832-16-C, 3832-20-C, 3832-25-C, 3832-32-C, 3832-35-C, 3832-41-C, 3832-44-C, 3832-46-C, 3832-51-C, 3832-54-C, 3832-73-C, 3832-76-C, 3832-83-C, 3832-86-C, 3832-92-C, 3832-114-C	
3834-ARBR-9100ESM, 3834-ARBR-930ESM	
3834-DRL-HSS-ES	
3834-UPSIZING	

Holesaw Set, Mixed 35–114 mm - 10 pcs



3835-SET-64

10	3870 g	1	3835-SET-64
----	--------	---	-------------

3830-35-C, 3830-73-C	
3833-35-C, 3833-73-C, 3833-76-C, 3833-114-C	
3834-ARBR-9100QC-C	
3834-ARBR-9100EL	
3834-DRL-EL	
3834-DRL	

Holesaw Set, Mixed 12–86 mm - 18 pcs



3835-SET-711

18	3680 g	1	3835-SET-711
----	--------	---	--------------

3830-35-C, 3830-41-C, 3830-51-C, 3830-73-C, 3830-76-C, 3830-83-C, 3830-86-C	
9629-12, 9629-14, 9629-16, 9629-18, 9629-20, 9629-22, 9629-25, 9629-28, 9629-32	
3834-ARBR-9100ESM	
3834-DRL-HSS-ES	

Arbors with Quick-Eject Function - Saves time and energy



3834-ARBR-EL/ES

19-30 mm	8.5 mm	1	3834-ARBR-930EL
32-159 mm	8.5 mm	1	3834-ARBR-9100EL
16-30 mm	8.5 mm	1	3834-ARBR-930ESM
32-152 mm	8.5 mm	1	3834-ARBR-9100ESM

Pilot Drills for Long Quick-Eject Arbors



3834-DRL-EL

6.35 mm	202 mm	1	3834-DRL-EL
---------	--------	---	-------------

Pilot Drills for Short Quick-Eject Arbors



3834-DRL-HSS-ES

Ø	L	Icons	Part No.
6.35 mm	138 mm		1 3834-DRL-ES
6.35 mm	138 mm		1 3834-DRL-HSS-ES

Upsize Adaptors for Enlarging Existing Holes



3834-upsize

L	Icons	Part No.
20.5 mm		1 3834-UPSIZE

Arbors for small holesaws 14-30mm



3834-ARBR

Ø	Drive	Icons	Part No.
14-30 mm	6.4 mm		1 3834-ARBR-630
14-30 mm	6.4 mm		1 3834-ARBR-630-C
14-30 mm	6.4 mm		1 3834-ARBR-730
14-30 mm	6.4 mm		1 3834-ARBR-730-C
14-30 mm	8.5 mm		1 3834-ARBR-930
14-30 mm	8.5 mm		1 3834-ARBR-930-C
14-30 mm	11.1 mm		4 3834-ARBR-1130
14-30 mm	11.1 mm		1 3834-ARBR-1130-C

Arbors with Quick-Change function



3834-ARBR-QC

Ø	Drive	Icons	Part No.
32-152 mm	8.5 mm		1 3834-ARBR-9100
32-152 mm	8.5 mm		1 3834-ARBR-9100-C
32-152 mm	8.5 mm		1 3834-ARBR-9100QC-C
32-152 mm	8.5 mm		1 3834-ARBR-9100QC-C
32-210 mm	11.1 mm		1 3834-ARBR-11152
32-210 mm	11.1 mm		1 3834-ARBR-11152-C
32-210 mm	11.1 mm		1 3834-ARBR-11152QC
32-210 mm	11.1 mm		1 3834-ARBR-11152QC-C
32-210 mm	15.4 mm		1 3834-ARBR-16152
32-210 mm	15.4 mm		1 3834-ARBR-16152QC

Arbors with SDS+ Drive



3834-ARBR-SD

Ø	Drive	Icons	Part No.
14-30 mm	SDS+ mm		1 3834-ARBR-SD30
32-210 mm	SDS+ mm		1 3834-ARBR-SD152QC

HSS Pilot Drills for Arbors



3834-DRL

Ø	L	Icons	Part No.
6.35 mm	81 mm		1 3834-DRL

Carbide Tipped Pilot Drills for Arbors



3834-DRL-CT/L

Ø	L	Icons	Part No.
6.35 mm	81 mm		1 3834-DRL-CT
6.35 mm	114 mm		1 3834-DRL-L

Arbor Extensions



3834-EXT

Ø	L	Icons	Part No.
11.1 mm	330 mm		1 3834-EXT-1
8.5 mm	330 mm		1 3834-EXT-2

Ejector Spring for arbors



3834-ES

Weight	Icons	Part No.
10 g		1 3834-ES



Arbor Adaptor for 3834-ARBR-630, 730, 930 and 1130



3834-ADP

20 g	1	3834-ADP

Spare Screws for Arbors



3834-SCREWS

9 g	1	3834-M6X29-SET
9 g	1	3834-M8X5-SET
9 g	1	3834-M8X6-SET
9 g	1	3834-M8X10-SET

SABRE SAWBLADES

Sandflex® Bi-Metal Sabre Sawblade Set for Metal



3940-M

100 mm	14	10	3940-100-14-ST-2P
100 mm	14	5	3940-100-14-ST-5P
100 mm	14	1	3940-100-14-ST-10P
100 mm	18	10	3940-100-18-ST-2P
100 mm	18	5	3940-100-18-ST-5P
100 mm	18	1	3940-100-18-ST-10P
150 mm	14	5	3940-150-14-ST-2P
150 mm	14	5	3940-150-14-ST-5P

150 mm	14	1	3940-150-14-ST-10P
150 mm	14	1	3940-150-14-ST-100P
150 mm	18	10	3940-150-18-ST-2P
150 mm	18	5	3940-150-18-ST-5P
150 mm	18	1	3940-150-18-ST-10P
150 mm	18	1	3940-150-18-ST-100P
228 mm	14	5	3940-228-14-ST-2P
228 mm	14	5	3940-228-14-ST-5P
228 mm	14	1	3940-228-14-ST-10P
228 mm	14	1	3940-228-14-ST-100P
228 mm	18	10	3940-228-18-ST-2P
228 mm	18	5	3940-228-18-ST-5P
228 mm	18	1	3940-228-18-ST-10P
228 mm	18	1	3940-228-18-ST-100P
300 mm	14	5	3940-300-14-ST-2P
300 mm	14	5	3940-300-14-ST-5P
300 mm	14	1	3940-300-14-ST-10P
300 mm	14	1	3940-300-14-ST-100P
300 mm	18	10	3940-300-18-ST-2P
300 mm	18	5	3940-300-18-ST-5P
300 mm	18	1	3940-300-18-ST-10P
300 mm	18	1	3940-300-18-ST-100P

Sandflex® Bi-Metal Sabre Sawblade Set for Heavy Metal



3940-HM

150 mm	8/12	10	3940-150-8/12-ST-2P
150 mm	8/12	5	3940-150-8/12-ST-5P
150 mm	8/12	1	3940-150-8/12-ST-10P
150 mm	8/12	1	3940-150-8/12-ST-100P
228 mm	8/12	10	3940-228-8/12-ST-2P
228 mm	8/12	5	3940-228-8/12-ST-5P
228 mm	8/12	1	3940-228-8/12-ST-10P
228 mm	8/12	1	3940-228-8/12-ST-100P
150 mm	10	10	3940-150-10-HST-2P
150 mm	10	5	3940-150-10-HST-5P
150 mm	10	1	3940-150-10-HST-10P
150 mm	10	1	3940-150-10-ST-100P
150 mm	10	10	3940-150-10-ST-2P
150 mm	10	5	3940-150-10-ST-5P
150 mm	10	1	3940-150-10-ST-10P
150 mm	14	10	3940-150-14-HST-2P
150 mm	14	5	3940-150-14-HST-5P
150 mm	14	1	3940-150-14-HST-10P
150 mm	18	10	3940-150-18-HST-2P
150 mm	18	5	3940-150-18-HST-5P
150 mm	18	1	3940-150-18-HST-10P
228 mm	10	10	3940-228-10-HST-2P
228 mm	10	5	3940-228-10-HST-5P
228 mm	10	1	3940-228-10-HST-10P
228 mm	10	1	3940-228-10-HST-100P
228 mm	10	10	3940-228-10-ST-2P
228 mm	10	5	3940-228-10-ST-5P
228 mm	10	1	3940-228-10-ST-10P
228 mm	10	1	3940-228-10-ST-100P

228 mm	14	10	3940-228-14-HST-2P
228 mm	14	5	3940-228-14-HST-5P
228 mm	14	1	3940-228-14-HST-10P
228 mm	18	10	3940-228-18-HST-2P
228 mm	18	5	3940-228-18-HST-5P
228 mm	18	1	3940-228-18-HST-10P
300 mm	10	10	3940-300-10-HST-2P
300 mm	10	5	3940-300-10-HST-5P
300 mm	10	1	3940-300-10-HST-10P
300 mm	14	10	3940-300-14-HST-2P
300 mm	14	5	3940-300-14-HST-5P
300 mm	14	1	3940-300-14-HST-10P
300 mm	18	10	3940-300-18-HST-2P
300 mm	18	5	3940-300-18-HST-5P
300 mm	18	1	3940-300-18-HST-10P

Sandflex® Bi-Metal Sabre Sawblade Set for Fine Metal



3940-FM

100 mm	24	10	3940-100-24-ST-2P
100 mm	24	5	3940-100-24-ST-5P
100 mm	24	1	3940-100-24-ST-10P
150 mm	24	5	3940-150-24-ST-2P
150 mm	24	5	3940-150-24-ST-5P
150 mm	24	1	3940-150-24-ST-10P
150 mm	24	1	3940-150-24-ST-100P

Sandflex® Bi-Metal Sabre Sawblade Set for Precision Metal



3940-PM

100 mm	14	10	3940-100-14-SC-2P
100 mm	14	5	3940-100-14-SC-5P
100 mm	18	10	3940-100-18-SC-2P
100 mm	18	5	3940-100-18-SC-5P
100 mm	24	10	3940-100-24-SC-2P
100 mm	24	5	3940-100-24-SC-5P

Sabre Saw Tungsten Carbide Tipped Blades for Heavy Duty Metal



3946-C HM

Length	Teeth	Quantity	Part Number
300 mm	8	1	3946-300-8-HST-10P
150 mm	8	10	3946-150-8-HST-1P
228 mm	8	10	3946-228-8-HST-1P
300 mm	8	10	3946-300-8-HST-1P

10P = 10 pieces

Sabre Saw Tungsten Carbide Tipped Blades for Stainless Steel



3946-C SS

Length	Teeth	Quantity	Part Number
150 mm	10	10	3946-150-10-HST-1P
228 mm	10	10	3946-228-10-HST-1P
300 mm	10	10	3946-300-10-HST-1P

Sabre Saw Diamond Grit Blades For Cast Iron And Ceramics



3946-D CI

Length	Teeth	Quantity	Part Number
100 mm	Grit	10	3946-100-DG-ST-2P
150 mm	Grit	10	3946-150-DG-ST-2P

Car Body Sandflex® Bi-Metal Reciprocating Sawblades



3845

Length	Teeth	Quantity	Part Number
91.5 mm	18	1	3845-18-10P
91.5 mm	24	1	3845-24-10P
90 mm	32	1	3845-32-10P

Sandflex® Bi-Metal Sabre Sawblades for Wood and Metal



3940-WM

Length	Teeth	Quantity	Part Number
150 mm	4/6	10	3940-150-4/6-SC-2P
150 mm	4/6	5	3940-150-4/6-SC-5P
150 mm	4/6	1	3940-150-4/6-SC-10P
150 mm	5/8	10	3940-150-5/8-SL-2P
150 mm	5/8	5	3940-150-5/8-SL-5P
150 mm	5/8	1	3940-150-5/8-SL-10P
150 mm	5/8	1	3940-150-5/8-SL-100P
150 mm	6	10	3940-150-6-ST-2P
150 mm	6	5	3940-150-6-ST-5P
150 mm	6	1	3940-150-6-ST-10P
228 mm	6	10	3940-228-6-SL-2P
228 mm	6	5	3940-228-6-SL-5P
228 mm	6	1	3940-228-6-SL-10P
300 mm	6	10	3940-300-6-SL-2P
300 mm	6	5	3940-300-6-SL-5P
300 mm	6	1	3940-300-6-SL-10P
300 mm	8/12	5	3940-300-8/12-SL-2P
300 mm	8/12	5	3940-300-8/12-SL-5P
300 mm	8/12	1	3940-300-8/12-SL-10P
300 mm	8/12	1	3940-300-8/12-SL-100P

Sandflex® Bi-Metal Sabre Sawblades for Fire Fighters and Rescuers



3940-FR

Length	Teeth	Quantity	Part Number
228 mm	10	10	3940-228-10-DSL-2P
228 mm	10	5	3940-228-10-DSL-5P
228 mm	10	1	3940-228-10-DSL-10P
228 mm	10	1	3940-228-10-DSL-100P

Sandflex® Bi-Metal Sabre Sawblades for Demolition



3940-D

Length	Teeth	Quantity	Part Number
150 mm	5/8	5	3940-150-5/8-DSL-2P
150 mm	5/8	5	3940-150-5/8-DSL-5P
150 mm	5/8	1	3940-150-5/8-DSL-10P
228 mm	5/8	10	3940-228-5/8-DSL-2P
228 mm	5/8	5	3940-228-5/8-DSL-5P
228 mm	5/8	1	3940-228-5/8-DSL-10P
300 mm	5/8	10	3940-300-5/8-DSL-2P
300 mm	5/8	5	3940-300-5/8-DSL-5P
300 mm	5/8	1	3940-300-5/8-DSL-10P

Sandflex® Bi-Metal Sabre Sawblades for Pallet Repair



3940-PR

Length	Teeth	Quantity	Part Number
228 mm	10/14	1	3940-228-10/14-PR13-10P
228 mm	10/14	1	3940-228-10/14-PR09-10P
228 mm	10/14	1	3940-228-10/14-PR09-100P
228 mm	10/14	1	3940-228-10/14-PR13-100P
228 mm	8/12	1	3940-228-8/12-PR13-100P
228 mm	10	1	3940-228-10-PR09-100P



Sabre Saw Tungsten Carbide Tipped Blades for Wood & Nails



3946-C_WM

Length	Teeth	Quantity	Part Number
150 mm	6	10	3946-150-6-DSL-1P
228 mm	6	10	3946-228-6-DSL-1P
300 mm	6	10	3946-300-6-DSL-1P

Sabre Saw HCS Blades for Wood and Plastic



3942-WP

Length	Teeth	Quantity	Part Number
228 mm	11	10	3942-228-11-HSL-2P
228 mm	11	5	3942-228-11-HSL-5P
228 mm	11	1	3942-228-11-HSL-10P

Reciprocating Curved Saw Blade for Medium Cut



3943-C30-JT-M

Length	Teeth	Quantity	Part Number
323 mm	13 in	10	3943-C30-JT-M
373 mm	15 in	10	3943-C35-JT-M

Sabre Saw HCS Blades for Wood



3942-W

Length	Teeth	Quantity	Part Number
228 mm	7	10	3942-228-7-HSL-2P
228 mm	7	5	3942-228-7-HSL-5P
228 mm	7	1	3942-228-7-HSL-10P
300 mm	7	10	3942-300-7-HSL-2P
300 mm	7	5	3942-300-7-HSL-5P
300 mm	7	1	3942-300-7-HSL-10P

Sandflex® Bi-Metal Sabre Sawblades for Plaster and Boards



3942-PB

Length	Teeth	Quantity	Part Number
150 mm	7	10	3942-150-7-SL-2P
150 mm	7	5	3942-150-7-SL-5P
150 mm	7	1	3942-150-7-SL-10P
228 mm	7	10	3942-228-7-SL-2P
228 mm	7	5	3942-228-7-SL-5P
228 mm	7	1	3942-228-7-SL-10P
300 mm	7	10	3942-300-7-SL-2P
300 mm	7	5	3942-300-7-SL-5P
300 mm	7	1	3942-300-7-SL-10P

Reciprocating Long Curved Saw Blade for Coarse Cut



3943-C35-JT-C

Length	Teeth	Quantity	Part Number
373 mm	15 in	10	3943-C35-JT-C

Sabre Saw HCS Blades for Coarse Wood



3942-CW

Length	Teeth	Quantity	Part Number
228 mm	5	10	3942-228-5-HSL-2P
228 mm	5	5	3942-228-5-HSL-5P
228 mm	5	1	3942-228-5-HSL-10P
300 mm	5	10	3942-300-5-HSL-2P
300 mm	5	5	3942-300-5-HSL-5P
300 mm	5	1	3942-300-5-HSL-10P

Reciprocating Curved Saw Blade for Fine Cut



3943-C30-JT-F

Length	Teeth	Quantity	Part Number
323 mm	13 in	10	3943-C30-JT-F

Reciprocating Straight Saw Blade for Fine Cut



3943-S20-JT-F

Length	Teeth	Quantity	Part Number
228 mm	9 in	10	3943-S20-JT-F

Reciprocating Straight Saw Blade for Coarse Cut



3943-R28-UT-C-2P



300 mm 12 in 10 3943-R28-UT-C-2P

Sandflex® Bi-Metal Sabre Sawblades Set for Heavy Metal and Demolition - 5 Pcs



3940-HDD-SET-5P



5 222 g 5 3940-HDD-SET-5P

3940-150-5/8-DSL, 3940-228-5/8-DSL, 3940-228-10-DSL, 3940-150-14-HST, 3940-228-14-HST, 3940-150-5/8-DSL, 3940-228-5/8-DSL, 3940-228-10-DSL, 3940-150-14-HST, 3940-228-14-HST

Sabre Sawblades Set for Wood and Metal - 12 Pcs



3940-MIX-SET-12P



12 480 g 6 3940-MIX-SET-12P

Sandflex® Bi-Metal Sabre Sawblades Set for Metal - 5 Pcs



3940-METAL-SET-5P

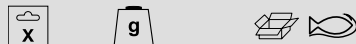

5 125 g 5 3940-METAL-SET-5P

3940-150-14-ST, 3940-150-18-ST, 3940-150-24-ST, 3940-228-18-ST, 3940-228-14-ST

Sabre Sawblades Set for Wood and Metal - 5 Pcs



3940-MIX-SET-5P



5 150 g 5 3940-MIX-SET-5P

3940-100-24-SC, 3940-150-18-ST, 3940-150-14-ST, 3940-228-6-SL, 3942-228-7-HSL, 3940-100-24-SC, 3940-150-18-ST, 3940-150-14-ST, 3940-228-6-SL, 3942-228-7-HSL

Sabre Sawblades Set for Wood - 5 Pcs



3942-WOOD-SET-5P



5 191 g 5 3942-WOOD-SET-5P

3940-228-6-SL, 3942-228-11-HSL, 2x 3942-228-7-HSL, 3942-150-7-SL, 3940-228-6-SL, 3942-228-11-HSL, 2x 3942-228-7-HSL, 3942-150-7-SL

Sandflex® Bi-Metal Sabre Sawblades Set for Metal - 12 Pcs



3940-METAL-SET-12P



12 460 g 6 3940-METAL-SET-12P

Sabre Sawblades Set for Plaster Wood and Metal - 10 Pcs



3940-MIX-SET-10P



10 245 g 4 3940-MIX-SET-10P

3940-100-24-SC, 3940-100-18-SC, 3940-150-24-ST, 3940-150-18-ST, 3940-150-14-ST, 3940-150-10-ST, 3940-228-6-SL, 3942-228-11-HSL, 3942-228-7-HSL, 3942-150-7-SL

Sabre Sawblades Set for Wood - 12 Pcs



3942-WOOD-SET-12P



12 525 g 6 3942-WOOD-SET-12P



Sabre Saw Stainless Steel Blades for Meat and Ice



3944

300 mm	4	10	3944-300-3-MEAT-1P

L			
77 mm	21	1	91-512-5P
77 mm	21	1	91-512-25P
77 mm	21	1	91-517-5P
77 mm	13	1	91-522-5P
132 mm	25	1	91-611-5P
77 mm	21	1	91-612-5P
77 mm	13	1	91-622-5P
132 mm	14	1	91-7V1-5P

Sabre Saw Tungsten Carbide Tipped Blades for Stone Materials



3946-CT

150 mm	6	5	3946-150-6-SL-1P
228 mm	3	5	3946-228-3-ST-1P

T-Shank Jigsaw Blades for Wood and Metal Cutting



91-WM

L			
132 mm	10/14	1	91-4PWM-5P
100 mm	10/14	1	91-623-5P

Sabre Saw Tungsten Carbide Tipped Blades for Bricks, LECA and Aerated Concrete



3946-C_B

300 mm	2	10	3946-300-2-CB-1P
457 mm	2	10	3946-457-2-CB-1P

T-Shank Jigsaw Blades for Wood Cutting



91-W

L			
117 mm	10	1	91-2PW-5P
132 mm	8	1	91-434-5P
105 mm	6	1	91-444-5P
100 mm	8	1	91-023-5P
77 mm	12	1	91-027-5P
100 mm	6	1	91-143-5P
100 mm	6	1	91-143-25P
100 mm	6	1	91-143-100P
100 mm	6	1	91-148-5P
100 mm	10	1	91-223-5P
100 mm	10	1	91-226-5P
132 mm	6	1	91-233-5P
100 mm	6	1	91-243-5P
77 mm	19	1	91-412-5P
100 mm	6	1	91-443-5P

JIGSAW BLADES

T-Shank Jigsaw Blades for Metal Cutting



91-M

100 mm	15/23	1	91-3PM-5P
100 mm	8	1	91-433-5P
77 mm	36	1	91-502-5P

Jigsaw Blade Set for Metal - 10 pcs



91-METAL-10P

10		1	91-METAL-10P

x3 91-512 (T118A), x3 91-522 (T118B), x1 91-433 (T127DF), x1 91-502 (T118G), x2 91-4PWM (T111HF)

Jigsaw Blade Set for Wood and Plastic - 10 pcs



91-WOOD-10P

10		1	91-WOOD-10P

x4 91-143 (T144D), x2 91-223 (T101B), x2 91-023 (T111C), x1 91-148 (T244D), x1 91-226 (T101BR)

Jigsaw Blade Set for Wood and Metal - 10 pcs



91-MIXED-10P

10		1	91-MIXED-10P

x3 91-143 (T144D), x1 91-223 (T101B), x1 91-148 (T244D), x2 91-512 (T118A), x2 91-522 (T118B), x1 91-623 (T111HF)

MULTI TOOL ACCESSORIES

Multi-Tool Standard Blade for Wood Cutting



92-S_W

1	35 x 50 x 97 mm	70	92-133-1P
3	35 x 50 x 97 mm	46	92-133-3P

Multi-Tool Standard Blade for Precision Wood Cutting



92-P_W

1	30 x 50 x 97 mm	70	92-205-1P
3	30 x 50 x 97 mm	46	92-205-3P
1	65 x 50 x 97 mm	70	92-229-1P

Multi-Tool Curved Standard Blade for Wood Cutting



92-C_W

1	65 x 50 x 97 mm	70	92-225-1P

Multi-Tool Standard Blade for Universal Cutting of Wood with Nails



92-U_WN

1	35 x 50 x 97 mm	70	92-160-1P
3	35 x 50 x 97 mm	46	92-160-3P

Multi-Tool Long-Life Standard Blade for Cutting Wood with Nails



92-LF_WN

1	50 x 50 x 97 mm	70	92-221-1P
1	65 x 50 x 97 mm	70	92-228-1P

Multi-Tool Standard Blade for Universal Cutting of Wood with Metal



92-U_WM

1	28 x 55 x 100 mm	70	92-222-1P
3	28 x 55 x 100 mm	46	92-222-3P
1	44 x 55 x 100 mm	70	92-223-1P
3	44 x 55 x 100 mm	46	92-223-3P

Multi-Tool Carbide Tipped Blade with TiN Coating for Metal Cutting



92-C_M

1	35 x 42 x 82 mm	70	92-236-1P

Multi-Tool Standard Blade for Fine Cutting in Metal



92-FM

1	30 x 50 x 97 mm	70	92-157-1P

Multi-Tool Segment Blade for Metal Cutting



92-M_S

1	85 mm	90	92-106-1P



Multi-Tool Segment Blade for Wood Cutting



92-SP



1 85 mm 90 92-113-1P

Multi-Tool Segment Blade for Slots and Reworking



92-CG_S



1 75 mm 90 92-118-1P

Multi-Tool Standard Knife for Soft Materials



92-MFK



1 41 x 42 x 87 mm 70 92-251-1P

Multi-Tool Circular Blade for Metal Cutting



92-M_R



115 85 mm 90 92-174-1P

Multi-Tool Segment Blade for Marble and Epoxy



92-DG_S



1 90 mm 50 92-166-1P

Multi-Tool Standard Scraper Blades



92-SC



1 52 x 38 x 83 mm 90 92-165-1P
1 50 x 38 x 83 mm 90 92-226-1P

Multi-Tool Standard Blade Set for Wood and Metal Cutting - 8 pcs



92-Universal_WM_Set



8 32 x 160 x 195 mm 34 92-WM-SET-8P

92-222-1Px 2, 92-223-1Px 2

92-228-1Px 2

92-160-1Px 2

Multi-Tool Triangular Blade for Rasping and Reworking



92-CR_T



1 80 mm 90 92-001-1P

Multi-Tool Mushroom Shape Cutting Blade



92-CM



1 70 x 30 x 75 mm 90 92-245-1P

Multi-Tool Triangular Sanding Pads



92-Sanding

1	80 mm	20	92-136-1P
5	82 mm	10	92-136-G40-5P
5	82 mm	10	92-136-G80-5P
5	82 mm	10	92-136-G120-5P
5	82 mm	10	92-136-G240-5P
1	93 mm	50	92-137-1P
5	94 mm	10	92-137-G40-5P
5	94 mm	10	92-137-G80-5P
5	94 mm	10	92-137-G120-5P
5	94 mm	10	92-137-G240-5P

CIRCULAR SAW BLADES

Circular Saw blades for Cordless Saws in Wood



8501-C

136 mm	24	1	8501-136-10-24C
136 mm	24	1	8501-136-20-24C
150 mm	24	1	8501-150-10-24C
160 mm	24	1	8501-160-20-24C
165 mm	24	1	8501-165-20-24C
184 mm	24	1	8501-184-20-24C
190 mm	24	1	8501-190-30-24C

Circular Saw blades for Portable-/Table Saws in Wood



8501-P/T

125 mm	16	1	8501-2
130 mm	16	1	8501-3
140 mm	16	1	8501-4
140 mm	24	1	8501-4F
140 mm	30	1	8501-4XF
150 mm	18	1	8501-5
150 mm	30	1	8501-5F
160 mm	18	1	8501-7
160 mm	30	1	8501-7F
170 mm	18	1	8501-10
170 mm	30	1	8501-10F
180 mm	20	1	8501-12
180 mm	40	1	8501-12F
184 mm	24	1	8501-13
184 mm	40	1	8501-13F
184 mm	24	1	8501-184-16-24
184 mm	40	1	8501-184-16-40
190 mm	20	1	8501-15
190 mm	40	1	8501-15F
190 mm	60	1	8501-190-30-60XF
200 mm	20	1	8501-16
200 mm	40	1	8501-16F
210 mm	20	1	8501-17
210 mm	40	1	8501-17F
210 mm	60	1	8501-210-30-60XF
230 mm	20	1	8501-22
230 mm	40	1	8501-22F
230 mm	60	1	8501-230-30-60XF
235 mm	30	1	8501-23
235 mm	40	1	8501-23F
235 mm	60	1	8501-235-30-60XF
250 mm	24	1	8501-28
250 mm	40	1	8501-28F
250 mm	60	1	8501-28XF

Circular Saw blades for Plunge Saws in Wood



8501-P

160 mm	48	1	8501-160-20-48XF
165 mm	48	1	8501-165-20-48XF

Circular Saw blades for Mitre Saws in Wood



8501-M

210 mm	48	1	8501-210-30-48SW
216 mm	24	1	8501-16SW
216 mm	48	1	8501-18SW
216 mm	60	1	8501-216-60SW
250 mm	60	1	8501-28SW
260 mm	24	1	8501-260-24SW
260 mm	40	1	8501-260-40SW
260 mm	60	1	8501-260-60SW
300 mm	60	1	8501-30SW
305 mm	40	1	8501-305-30-40SW
305 mm	60	1	8501-305-30-60SW

Circular Saw blades for Site Saws in Wood



8501-S

300 mm	30	1	8501-30
300 mm	40	1	8501-30F
300 mm	60	1	8501-30XF
315 mm	30	1	8501-31
315 mm	40	1	8501-31F
400 mm	40	1	8501-40



Circular Saw blades for Mitre Saws in Aluminium and Plastic



8501-AP

Ø	Length	Material	Model
210 mm	48	Alu	8501-17S
216 mm	48	Alu	8501-18S
250 mm	80	Alu	8501-28S
260 mm	80	Alu	8501-260-30-80S
300 mm	96	Alu	8501-30S
305 mm	96	Alu	8501-305-30-96S

ABRASIVE CUTTING DISCS

Abrasive High-Performance Cutting Discs for General Purpose Inox & Metal



391-T41_IM

Ø	Material	Model
115x1.6 mm	Alu	3911-2301922XDT
115x1.0 mm	Alu	3911-2302522XDT
125x1.6 mm	Alu	3911-751010XTM
180x2.0 mm	Alu	3911-115-T41-IM
230x2.5 mm	Alu	3911-115-T41-IM
115x1.0 mm	Alu	3911-125-T41-IM
125x1.0 mm	Alu	3911-180-T41-IM
125x1.0 mm	Alu	3911-230-T41-IM
180x1.6 mm	Alu	3912-115-T41-IM
230x1.9 mm	Alu	3912-125-T41-IM
115x1.0 mm	Alu	3911-1251T41-IM
180x1.6 mm	Alu	3911-1801T41-IM
230x1.9 mm	Alu	3911-2301T41-IM
230x3.0 mm	Alu	3911-2303T41-IM
115x1 mm	Alu	3911-115-IM-10P
125x1 mm	Alu	3911-125-IM-10P

Abrasive High-Performance Cutting Discs for Aluminium



391-T41_ALU

Ø	Material	Model
115 mm	Alu	3911-115-T41-AL
125 mm	Alu	3911-125-T41-AL

Abrasive High-Performance Cutting Discs for Inox



391-T41-I

Ø	Material	Model
115x1.0 mm	Inox	3911-115-T41-I
125x1.0 mm	Inox	3911-125-T41-I
150x1.0 mm	Inox	3911-150-T41-I
180x1.6 mm	Inox	3911-180-T41-I
230x1.9 mm	Inox	3911-230-T41-I

Abrasive High-Performance Cutting Discs for Stainless Steel & Metal



391-T41_CS

Ø	Material	Model
356 mm	CS	3911-350-X2TM
400 mm	CS	3911-400-F2TM
400 mm	CS	3911-400-X2TM

Abrasive High-Performance Cutting Discs for Metal



391-T42_M

Ø	Material	Model
115x2.5 mm	Metal	3911-115-T42-M
125x2.5 mm	Metal	3911-125-T42-M
150x2.5 mm	Metal	3911-150-T42-M
180x3.2 mm	Metal	3911-180-T42-M
230x3.2 mm	Metal	3911-230-T42-M

Abrasive High-Performance Cutting Discs for Building & Stone



391-T42_ST

Ø	Material	Model
115x3.2 mm	Stone	3912-115-T42-ST
125x3.2 mm	Stone	3912-125-T42-ST
180x3.2 mm	Stone	3912-180-T42-ST
230x3.2 mm	Stone	3912-230-T42-ST

Abrasive High-Performance Grinding Discs for Inox & Metal



392-T27_IM

Ø	Material	Model
115x6.4 mm	Inox	3921-115-T27-IM
125x6.4 mm	Inox	3921-125-T27-IM
150x6.4 mm	Inox	3921-150-T27-IM
180x6.5 mm	Inox	3921-180-T27-IM
230x6.5 mm	Inox	3921-230-T27-IM

Abrasive Conical Flap Grinding Discs for
Inox & Metal



392-FLAP_C

Ø	Icons	Quantity	Product Code
115 mm		20	3926-115IM-C40
115 mm		20	3926-115IM-C60
115 mm		20	3926-115IM-C80
115 mm		20	3926-115IM-C120
125 mm		20	3926-125IM-C40
125 mm		20	3926-125IM-C60
125 mm		20	3926-125IM-C80
125 mm		20	3926-125IM-C120

Abrasive Diamond Cutting Discs for
Ceramic & tiles



391-DIAM_C

Ø	Icons	Quantity	Product Code
115 mm		100	3916-115-10P-CE
125 mm		100	3916-125-10P-CE
115 mm		100	3917-115-7S-C
125 mm		100	3917-125-7S-C

Abrasive Diamond Cutting Discs for
Reinforced Concrete



391-DIAM_RC

Ø	Quantity	Product Code
230 mm	25	3916-230-10L-RC

Abrasive Flap Grinding Discs for Inox &
Metal



392-FLAP_P

Ø	Icons	Quantity	Product Code
115 mm		20	3927-115IM-P40
115 mm		20	3927-115IM-P60
115 mm		20	3927-115IM-P80
115 mm		20	3927-115IM-P120
125 mm		20	3927-125IM-P40
125 mm		20	3927-125IM-P60
125 mm		20	3927-125IM-P80
125 mm		20	3927-125IM-P120
125 mm		12	3927-125-40-3P
125 mm		12	3927-125-60-3P
125 mm		12	3927-125-80-3P
125 mm		12	3927-125-120-3P

Abrasive Diamond Cutting Discs for
General Purpose Stone



391-DIAM_U

Ø	Icons	Quantity	Product Code
115 mm		100	3916-115-10S-UE
125 mm		100	3916-125-10S-UE
150 mm		50	3916-150-10S-UE
180 mm		50	3916-180-10S-UE
230 mm		25	3916-230-10S-UE
115 mm		100	3917-115-7S-U
125 mm		100	3917-125-7S-U
230 mm		25	3917-230-7S-U

Easy-Cut Bandsaw Blades with Portaband



3857 Easy-Cut Portaband

Icons	Icons	Quantity	Product Code
S	EZ	1	3857-13-0.6-EZ-S-3P690
S	EZ	1	3857-13-0.6-EZ-S-3P730
S	EZ	1	3857-13-0.6-EZ-S-3P835
S	EZ	1	3857-13-0.6-EZ-S-3P900
S	EZ	1	3857-13-0.6-EZ-S-3P1140
M	EZ	1	3857-13-0.6-EZ-M-3P690
M	EZ	1	3857-13-0.6-EZ-M-3P730
M	EZ	1	3857-13-0.6-EZ-M-3P835
M	EZ	1	3857-13-0.6-EZ-M-3P900
M	EZ	1	3857-13-0.6-EZ-M-3P1140

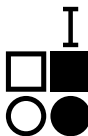

CARBIDE ROTARY BURRS

Tungsten Carbide Cylindrical Rotary Burrs for Metal



A

Ø	Texture	Profile	Item
3 mm	Medium	1	A0313M03
3 mm	Medium	1	A0313M03E
3 mm	Medium	1	A0313M03X
3 mm	Medium	1	A0313M03XE
3 mm	Medium	1	A0313M03XE-60
3 mm	Medium	1	A0313M03XE-80
6.3 mm	Medium	1	A0613M03X
6 mm	Medium	1	A0616M06
6 mm	Medium	1	A0616M06E
6 mm	Medium	1	A0616M06X
6 mm	Medium	1	A0616M06XE
8 mm	Medium	1	A0820M06
8 mm	Medium	1	A0820M06E
8 mm	Medium	1	A0820M06X
8 mm	Medium	1	A0820M06XE
10 mm	Medium	1	A1020M06
10 mm	Medium	1	A1020M06E
9.6 mm	Medium	1	A1020M06X
9.6 mm	Medium	1	A1020M06XE
12 mm	Medium	1	A1225M06
12.7 mm	Medium	1	A1225M06E
12 mm	Medium	1	A1225M06X
12.7 mm	Medium	1	A1225M08
12.7 mm	Medium	1	A1225M08E
12.7 mm	Medium	1	A1225M08X
12.7 mm	Medium	1	A1225M08XE
16 mm	Medium	1	A1625M06
16 mm	Medium	1	A1625M06X
16 mm	Medium	1	A1625M06XE
16 mm	Medium	1	A1625M08
16 mm	Medium	1	A1625M08E
16 mm	Medium	1	A1625M08X
16 mm	Medium	1	A1625M08XE

* non stock standard

Tungsten Carbide Cylindrical Round Nose Rotary Burrs for Metal



C

Ø	Texture	Profile	Item
3 mm	Medium	1	C0313M03
3 mm	Medium	1	C0313M03X
6.3 mm	Medium	1	C0616M03X
6 mm	Medium	1	C0616M06
6 mm	Medium	1	C0616M06X
8 mm	Medium	1	C0820M06
8 mm	Medium	1	C0820M06X

Ø	Texture	Profile	Item
9.6 mm	Medium	1	C1020M06
10 mm	Medium	1	C1020M06X
12 mm	Medium	1	C1225M06
12 mm	Medium	1	C1225M06X
12.7 mm	Medium	1	C1225M08X
16 mm	Medium	1	C1625M06
16 mm	Medium	1	C1625M06X
16 mm	Medium	1	C1625M08
16 mm	Medium	1	C1625M08X

* non stock standard

Tungsten Carbide Spherical Rotary Burrs for Metal



D

Ø	Texture	Profile	Item
3 mm	Medium	1	D0303M03
3 mm	Medium	1	D0303M03X
6.3 mm	Medium	1	D0605M03X
6 mm	Medium	1	D0606M06
6 mm	Medium	1	D0606M06X
8 mm	Medium	1	D0807M06
8 mm	Medium	1	D0807M06X
9.6 mm	Medium	1	D1009M06
9.6 mm	Medium	1	D1009M06X
12.7 mm	Medium	1	D1211M06
12.7 mm	Medium	1	D1211M06X
16 mm	Medium	1	D1614M06
16 mm	Medium	1	D1614M06X
16 mm	Medium	1	D1614M08
16 mm	Medium	1	D1614M08X

* non stock standard

Tungsten Carbide Oval Rotary Burrs for Metal



E

Ø	Texture	Profile	Item
3 mm	Medium	1	E0308M03
3 mm	Medium	1	E0308M03X
6 mm	Medium	1	E0614M06
8 mm	Medium	1	E0816M06
8 mm	Medium	1	E0816M06X
9.6 mm	Medium	1	E1018M06
9.6 mm	Medium	1	E1018M06X
12.7 mm	Medium	1	E1222M06
12.7 mm	Medium	1	E1222M06X
12.7 mm	Medium	1	E1222M08
12.7 mm	Medium	1	E1222M08X
16 mm	Medium	1	E1625M06

Ø	Texture	Profile	Item
16 mm	Medium	1	E1625M06X
16 mm	Medium	1	E1625M08
16 mm	Medium	1	E1625M08X

* non stock standard

Tungsten Carbide Arch Round Nose Rotary Burrs for Metal



F

Ø	Texture	Profile	Item
3 mm	Medium	1	F0313M03
3 mm	Medium	1	F0313M03X
6.3 mm	Medium	1	F0613M03X
6 mm	Medium	1	F0618M06
6 mm	Medium	1	F0618M06X
8 mm	Medium	1	F0820M06
8 mm	Medium	1	F0820M06X
9.6 mm	Medium	1	F1020M06
9.6 mm	Medium	1	F1020M06X
12.7 mm	Medium	1	F1225M06
12.7 mm	Medium	1	F1225M06X
12.7 mm	Medium	1	F1225M08
12.7 mm	Medium	1	F1225M08X
16 mm	Medium	1	F1625M06
16 mm	Medium	1	F1625M06X
16 mm	Medium	1	F1625M08

* non stock standard

Tungsten Carbide Arch Pointed Nose Rotary Burrs for Metal



G

Ø	Texture	Profile	Item
3 mm	Medium	1	G0313M03
3 mm	Medium	1	G0313M03X
6.3 mm	Medium	1	G0613M03X
6 mm	Medium	1	G0618M06
6 mm	Medium	1	G0618M06X
8 mm	Medium	1	G0820M06
8 mm	Medium	1	G0820M06X
9.6 mm	Medium	1	G1020M06
9.6 mm	Medium	1	G1020M06X
12.7 mm	Medium	1	G1225M06
12.7 mm	Medium	1	G1225M06X
12 mm	Medium	1	G1225M08
12 mm	Medium	1	G1225M08X
16 mm	Medium	1	G1625M06
16 mm	Medium	1	G1625M06X
16 mm	Medium	1	G1625M08
16 mm	Medium	1	G1625M08X

* non stock standard

Tungsten Carbide Flame Rotary Burrs for Metal



H

6 mm	Medium	1	H0613M03X	
10 mm	Medium	1	H1025M06	
10 mm	Medium	1	H1025M06X	
12.7 mm	Medium	1	H1232M06	
12.7 mm	Medium	1	H1232M06X	
16 mm	Medium	1	H1635M06X	
16 mm	Medium	1	H1635M06	
16 mm	Medium	1	H1635M08	
16 mm	Medium	1	H1635M08X	

* non stock standard

Tungsten Carbide 60° Cone Rotary Burrs for Metal



J

6 mm	Medium	1	J0604M06	
9.6 mm	Medium	1	J1010M06	
12.7 mm	Medium	1	J1212M06	
16 mm	Medium	1	J1616M06	
16 mm	Medium	1	J1616M08	

* non stock standard

Tungsten Carbide 90° Cone Rotary Burrs for Metal



K

6 mm	Medium	1	K0602M06	
9.6 mm	Medium	1	K1008M06	
12.7 mm	Medium	1	K1210M06	
16 mm	Medium	1	K1612M06	
16 mm	Medium	1	K1612M08	

* non stock standard

Tungsten Carbide Conical Round Nose Rotary Burrs for Metal



L

10 mm	Medium	1	L1020M06	
10 mm	Medium	1	L1020M06X	
12.7 mm	Medium	1	L1225M06	
12.7 mm	Medium	1	L1225M06X	
12.7 mm	Medium	1	L1230M06	
12.7 mm	Medium	1	L1230M06X	
16 mm	Medium	1	L1630M06	
16 mm	Medium	1	L1630M06X	
16 mm	Medium	1	L1630M08	
16 mm	Medium	1	L1630M08X	

* non stock standard

Tungsten Carbide Conical Pointed Nose Rotary Burrs for Metal



M

3 mm	Medium	1	M0310M03	
3 mm	Medium	1	M0310M03X	
6.3 mm	Medium	1	M0613M03X	
6 mm	Medium	1	M0618M06	
6 mm	Medium	1	M0618M06X	
9.5 mm	Medium	1	M1022M06	
9.5 mm	Medium	1	M1022M06X	
12.7 mm	Medium	1	M1227M06	
12.7 mm	Medium	1	M1227M06X	
12.7 mm	Medium	1	M1227M08	
16 mm	Medium	1	M1630M06	
16 mm	Medium	1	M1630M06X	
16 mm	Medium	1	M1630M08	
16 mm	Medium	1	M1630M08X	

* non stock standard

Tungsten Carbide Inverted Cone Nose Rotary Burrs for Metal



N

3 mm	Medium	1	N0306M03	
3 mm	Medium	1	N0306M03E	
6 mm	Medium	1	N0607M06	
12.7 mm	Medium	1	N1213M06	
12.7 mm	Medium	1	N1213M06X	
16 mm	Medium	1	N1613M06	
16 mm	Medium	1	N1613M06X	
16 mm	Medium	1	N1613M08	

* non stock standard

Tungsten Carbide Cylindrical Nose Rotary Burrs for Aluminium



A-AL

6 mm	AL	1	A0616AL06E	
12.7 mm	AL	1	A1225AL06E	
12.7 mm	AL	1	A1225AL08E	
16 mm	AL	1	A1625AL08XE	

Tungsten Carbide Cylindrical Round Nose Rotary Burrs for Aluminium



C-AL

6 mm	AL	1	C0616AL06	
12.7 mm	AL	1	C1225AL06	



Tungsten Carbide Spherical Nose Rotary Burrs for Aluminium



D-AL

Ø	Material	Qty	Part No.
12.7 mm	AL	1	D1211AL06
12.7 mm	AL	1	D1211AL08

* non stock standard

Tungsten Carbide Cylindrical Rotary Special Burrs for Repairing Tyre



A/G

Ø	Material	Qty	Part No.
6 mm	TR	1	A0625M06X

* non stock standard

Tungsten Carbide Spherical Rotary Burrs for High Alloy Steel



D-S

Ø	Material	Qty	Part No.
6 mm	Steel	5	D0606S06
9.6 mm	Steel	5	D1010S06
12.7 mm	Steel	5	D1212S06

Tungsten Carbide Arch Round Nose Rotary Burrs for Aluminium



F-AL

Ø	Material	Qty	Part No.
6 mm	AL	1	F0618AL06
12.7 mm	AL	1	F1225AL06
12.7 mm	AL	1	F1225AL08

Tungsten Carbide Cylindrical Rotary Burrs for High Alloy Steel



A-S

Ø	Material	Qty	Part No.
6 mm	Steel	5	A0618S06E
9.6 mm	Steel	5	A1020S06
9.6 mm	Steel	5	A1020S06E
12.7 mm	Steel	5	A1225S06
12.7 mm	Steel	5	A1225S06E

Tungsten Carbide Arch Round Nose Rotary Burrs for High Alloy Steel



F-S

Ø	Material	Qty	Part No.
6 mm	Steel	5	F0618S06
9.6 mm	Steel	5	F1020S06
12.7 mm	Steel	5	F1225S06

Tungsten Carbide Conical Round Nose Rotary Burrs for Aluminium



L-AL

Ø	Material	Qty	Part No.
12.7 mm	AL	1	L1230AL06
12.7 mm	AL	1	L1230AL08

* non stock standard

Tungsten Carbide Cylindrical Round Nose Rotary Burrs for High Alloy Steel



C-S

Ø	Material	Qty	Part No.
6 mm	Steel	5	C0618S06
9.6 mm	Steel	5	C1020S06
12.7 mm	Steel	5	C1225S06

Tungsten Carbide Arch Pointed Nose Rotary Burrs for High Alloy Steel



G-S

Ø	Material	Qty	Part No.
9.6 mm	Steel	5	G1020S06
12.7 mm	Steel	5	G1225S06

Tungsten Carbide Conical Round Nose Rotary Burrs for High Alloy Steel



L-S

Ø	Material	Qty	Part No.
9.6 mm	Steel	5	L1020S06
12.7 mm	Steel	5	L1228S06

Tungsten Carbide Spherical Rotary Burrs for Stainless Steel



D-I

Ø	Material	Qty	Part No.
3 mm	Inox	5	D0303I03
6 mm	Inox	5	D0606I06
9.6 mm	Inox	5	D1010I06
12.7 mm	Inox	5	D1212I06

Tungsten Carbide Arch Pointed Nose Rotary Burrs for Stainless Steel



G-I

Ø	Material	Qty	Part No.
9.6 mm	Inox	5	G1020I06
12.7 mm	Inox	5	G1225I06

Tungsten Carbide Cylindrical Rotary Burrs for Stainless Steel



A-I

Ø	Material	Qty	Part No.
3 mm	Inox	5	A0314I03
6 mm	Inox	5	A0618I06
9.6 mm	Inox	5	A1020I06
12.7 mm	Inox	5	A1225I06

Tungsten Carbide Oval Rotary Burrs for Stainless Steel



E-I

Ø	Material	Qty	Part No.
9.6 mm	Inox	5	E1015I06
12.7 mm	Inox	5	E1220I06

Tungsten Carbide Flame Rotary Burrs for Stainless Steel



H-I

Ø	Material	Qty	Part No.
9.6 mm	Inox	5	H1020I06
12.7 mm	Inox	5	H1232I06

Tungsten Carbide Cylindrical Round Nose Rotary Burrs for Stainless Steel



C-I

Ø	Material	Qty	Part No.
3 mm	Inox	5	C0312I03
6 mm	Inox	5	C0618I06
9.6 mm	Inox	5	C1020I06
12.7 mm	Inox	5	C1225I06

Tungsten Carbide Arch Round Nose Rotary Burrs for Stainless Steel



F-I

Ø	Material	Qty	Part No.
3 mm	Inox	5	F0312I03
6 mm	Inox	5	F0618I06
9.6 mm	Inox	5	F1020I06
12.7 mm	Inox	5	F1225I06

Tungsten Carbide Conical Round Nose Rotary Burrs for Stainless Steel



L-I

Ø	Material	Qty	Part No.
9.6 mm	Inox	5	L1020I06
12.7 mm	Inox	5	L1228I06



Tungsten Carbide Arch Pointed Nose Rotary Burrs for Tire Repair



TR

Size	Application	Qty	Part No.
3 mm	Tire Repair	5	TR0325M03X-50
4.5 mm	Tire Repair	5	TR0636M06X-65
6 mm	Tire Repair	5	TR0650M06X-80
8 mm	Tire Repair	5	TR0860M08X-110
8 mm	Tire Repair	5	TR4.530M06X-90

Tungsten Carbide Rotary Burrs Set for Metal 10 and 12 mm - 5 Pcs



ST-1-5P

Qty	Weight (g)	Part No.
5	376 g	1 RB-SET1-M06X-5P

A1020M06XE	
C1225M06X	
F1225M06X	
G1020M06X	
L1230M06X	

Tungsten Carbide Rotary Burrs Set for Metal 10 mm - 5 Pcs



ST-2-5P

Qty	Weight (g)	Part No.
5	313 g	1 RB-SET2-M06X-5P

BAHCO

A1020M06XE	
C1020M06X	
D1009M06X	
F1020M06X	
L1020M06X	

Tungsten Carbide Rotary Burrs Set for Metal - 10 Pcs



ST-10P

Qty	Weight (g)	Part No.
10	542 g	1 RB-SET-M06X-10P

A1020M06XE, A1225M06X	
C1020M06X, C1225M06X	
D1211M06X	
E1018M06X	
F1225M06X	
G1020M06X, G1225M06X	
L1230M06X	

Tungsten Carbide Rotary Burrs Set for Aluminium - 5 pcs



ALU-5P

Qty	Weight (g)	Part No.
5	380 g	1 RB-SET-AL06-5P

A1225AL06E	
C1225AL06	
D1211AL06	
F1225AL06	
L1230AL06	

DRILL BITS

SDS Max Drill Bits 4-cutter for Reinforced Concrete



4656

Size	Length (mm)	Qty	Part No.
12.0 mm	340 mm	1	4656-12-340
12.0 mm	540 mm	1	4656-12-540
14.0 mm	340 mm	1	4656-14-340
14.0 mm	540 mm	1	4656-14-540
15.0 mm	340 mm	1	4656-15-340
16.0 mm	340 mm	1	4656-16-340
16.0 mm	540 mm	1	4656-16-540
16.0 mm	940 mm	1	4656-16-940
16.0 mm	1320 mm	1	4656-16-1320
18.0 mm	340 mm	1	4656-18-340
18.0 mm	540 mm	1	4656-18-540
18.0 mm	940 mm	1	4656-18-940
18.0 mm	1320 mm	1	4656-18-1320
20.0 mm	320 mm	1	4656-20-320
20.0 mm	520 mm	1	4656-20-520
20.0 mm	920 mm	1	4656-20-920
20.0 mm	1320 mm	1	4656-20-1320
22.0 mm	320 mm	1	4656-22-320
22.0 mm	520 mm	1	4656-22-520
22.0 mm	920 mm	1	4656-22-920
22.0 mm	1320 mm	1	4656-22-1320
24.0 mm	320 mm	1	4656-24-320
24.0 mm	520 mm	1	4656-24-520
25.0 mm	320 mm	1	4656-25-320
25.0 mm	520 mm	1	4656-25-520
25.0 mm	920 mm	1	4656-25-920
25.0 mm	1320 mm	1	4656-25-1320
26.0 mm	520 mm	1	4656-26-520
28.0 mm	370 mm	1	4656-28-370
28.0 mm	570 mm	1	4656-28-570
28.0 mm	670 mm	1	4656-28-670
28.0 mm	920 mm	1	4656-28-920
30.0 mm	370 mm	1	4656-30-370
30.0 mm	570 mm	1	4656-30-570
32.0 mm	370 mm	1	4656-32-370
32.0 mm	570 mm	1	4656-32-570
32.0 mm	920 mm	1	4656-32-920
32.0 mm	1320 mm	1	4656-32-1320
35.0 mm	370 mm	1	4656-35-370
35.0 mm	570 mm	1	4656-35-570
35.0 mm	670 mm	1	4656-35-670
37.0 mm	370 mm	1	4656-37-370
37.0 mm	570 mm	1	4656-37-570
37.0 mm	920 mm	1	4656-37-920
38.0 mm	370 mm	1	4656-38-370
38.0 mm	570 mm	1	4656-38-570
40.0 mm	370 mm	1	4656-40-370
40.0 mm	570 mm	1	4656-40-570
40.0 mm	920 mm	1	4656-40-920
40.0 mm	1320 mm	1	4656-40-1320
45.0 mm	570 mm	1	4656-45-570
45.0 mm	920 mm	1	4656-45-920
50.0 mm	570 mm	1	4656-50-570
52.0 mm	570 mm	1	4656-52-570

SDS+ Drill Bits 4-cutter for Reinforced Concrete



4651



Ø	L		
5.0 mm	115 mm	1	4651-5-110
5.0 mm	110 mm	1	4651-5-110-10P
5.0 mm	165 mm	1	4651-5-160
5.0 mm	160 mm	1	4651-5-160-10P
5.0 mm	265 mm	1	4651-5-260
5.5 mm	110 mm	10	4651-5,5-110-10P
5.5 mm	160 mm	1	4651-5,5-160-10P
5.5 mm	115 mm	1	4651-5,5-110
5.5 mm	165 mm	1	4651-5,5-160
6.0 mm	115 mm	1	4651-6-110
6.0 mm	110 mm	1	4651-6-110-10P
6.0 mm	165 mm	1	4651-6-160
6.0 mm	160 mm	1	4651-6-160-10P
6.0 mm	215 mm	1	4651-6-210
6.0 mm	265 mm	1	4651-6-260
6.0 mm	315 mm	1	4651-6-310
6.5 mm	110 mm	50	4651-6,5-110
6.5 mm	165 mm	1	4651-6,5-160
6.5 mm	160 mm	1	4651-6,5-160-10P
6.5 mm	215 mm	1	4651-6,5-210
6.5 mm	265 mm	1	4651-6,5-260
6.5 mm	315 mm	1	4651-6,5-310
7.0 mm	115 mm	1	4651-7-110
7.0 mm	165 mm	1	4651-7-160
8.0 mm	115 mm	1	4651-8-110
8.0 mm	165 mm	1	4651-8-160
8.0 mm	160 mm	1	4651-8-160-10P
8.0 mm	215 mm	1	4651-8-210
8.0 mm	210 mm	1	4651-8-210-10P
8.0 mm	265 mm	1	4651-8-260
8.0 mm	315 mm	1	4651-8-310
8.0 mm	465 mm	1	4651-8-460
10.0 mm	115 mm	1	4651-10-110
10.0 mm	165 mm	1	4651-10-160
10.0 mm	160 mm	1	4651-10-160-10P
10.0 mm	215 mm	1	4651-10-210
10.0 mm	210 mm	1	4651-10-210-10P
10.0 mm	265 mm	1	4651-10-260
10.0 mm	315 mm	1	4651-10-310
10.0 mm	455 mm	1	4651-10-450
10.0 mm	600 mm	1	4651-10-600
10.0 mm	1000 mm	1	4651-10-1000
12.0 mm	160 mm	1	4651-12-160
12.0 mm	160 mm	1	4651-12-160-10P
12.0 mm	210 mm	1	4651-12-210
12.0 mm	210 mm	1	4651-12-210-10P
12.0 mm	260 mm	1	4651-12-260
12.0 mm	310 mm	1	4651-12-310
12.0 mm	450 mm	1	4651-12-450
12.0 mm	600 mm	1	4651-12-600
12.0 mm	1000 mm	1	4651-12-1000
14.0 mm	160 mm	1	4651-14-160
14.0 mm	210 mm	1	4651-14-210
14.0 mm	260 mm	1	4651-14-260
14.0 mm	310 mm	1	4651-14-310
14.0 mm	450 mm	1	4651-14-450
14.0 mm	600 mm	1	4651-14-600
14.0 mm	1000 mm	1	4651-14-1000
15.0 mm	160 mm	1	4651-15-160
15.0 mm	260 mm	1	4651-15-260
15.0 mm	450 mm	1	4651-15-450
16.0 mm	160 mm	1	4651-16-160
16.0 mm	210 mm	1	4651-16-210
16.0 mm	260 mm	1	4651-16-260
16.0 mm	310 mm	1	4651-16-310
16.0 mm	450 mm	1	4651-16-450
16.0 mm	600 mm	1	4651-16-600

Ø	L		
16.0 mm	1000 mm	1	4651-16-1000
18.0 mm	250 mm	1	4651-18-250
18.0 mm	450 mm	1	4651-18-450
20.0 mm	250 mm	1	4651-20-250
20.0 mm	450 mm	1	4651-20-450
22.0 mm	250 mm	1	4651-22-250
22.0 mm	450 mm	1	4651-22-450
24.0 mm	250 mm	1	4651-24-250
24.0 mm	450 mm	1	4651-24-450
25.0 mm	250 mm	1	4651-25-250
25.0 mm	450 mm	1	4651-25-450
28.0 mm	250 mm	1	4651-28-250
28.0 mm	450 mm	1	4651-28-450
30.0 mm	250 mm	1	4651-30-250
30.0 mm	450 mm	1	4651-30-450
32.0 mm	450 mm	1	4651-32-450

Drill Set for Reinforced Concrete SDS + 4C - 5 pcs



4651-SET-5



X		
5	1	4651-SET-5

4651-5-110, 4651-6-110, 4651-6-160, 4651-8-160, 4651-10-160

Drill Set for Reinforced Concrete SDS + 4C - 7 pcs



4651-SET-7



X		
7	1	4651-SET-7

4651-5-110, 4651-6-110, 4651-8-110, 4651-6-160, 4651-8-160, 4651-10-160, 4651-12-160

SDS+ Drill Bits 2-cutter for Concrete



4652



Ø	L		
3.0 mm	110 mm	50	4652-3-110
3.5 mm	110 mm	50	4652-3,5-110
4.0 mm	110 mm	1	4652-4-110
4.0 mm	160 mm	1	4652-4-160
5.0 mm	110 mm	1	4652-5-110
5.0 mm	160 mm	1	4652-5-160
5.0 mm	110 mm	1	4652-5-110-10P
5.0 mm	160 mm	1	4652-5-160-10P
5.0 mm	210 mm	1	4652-5-210
5.5 mm	110 mm	1	4652-5,5-110
5.5 mm	110 mm	10	4652-5,5-110-10P
5.5 mm	160 mm	1	4652-5,5-160
5.5 mm	160 mm	1	4652-5,5-160-10P
5.5 mm	210 mm	50	4652-5,5-210
6.0 mm	110 mm	1	4652-6-110
6.0 mm	110 mm	1	4652-6-110-10P
6.0 mm	160 mm	50	4652-6-160
6.0 mm	160 mm	1	4652-6-160-10P
6.0 mm	210 mm	1	4652-6-210
6.0 mm	260 mm	1	4652-6-260
6.5 mm	110 mm	1	4652-6,5-110
6.5 mm	160 mm	1	4652-6,5-160
6.5 mm	160 mm	1	4652-6,5-160-10P
6.5 mm	210 mm	1	4652-6,5-210
7.0 mm	110 mm	1	4652-7-110
7.0 mm	160 mm	1	4652-7-160
8.0 mm	110 mm	1	4652-8-110
8.0 mm	160 mm	1	4652-8-160
8.0 mm	160 mm	1	4652-8-160-10P
8.0 mm	210 mm	1	4652-8-210
8.0 mm	210 mm	1	4652-8-210-10P
8.0 mm	260 mm	1	4652-8-260
8.0 mm	460 mm	1	4652-8-460
9.0 mm	160 mm	1	4652-9-160
9.0 mm	210 mm	1	4652-9-210
10.0 mm	110 mm	1	4652-10-110
10.0 mm	160 mm	1	4652-10-160
10.0 mm	160 mm	1	4652-10-160-10P
10.0 mm	210 mm	1	4652-10-210
10.0 mm	210 mm	1	4652-10-210-10P
10.0 mm	260 mm	1	4652-10-260
10.0 mm	310 mm	1	4652-10-310
10.0 mm	450 mm	1	4652-10-450
10.0 mm	600 mm	1	4652-10-600
11.0 mm	160 mm	1	4652-11-160
11.0 mm	260 mm	1	4652-11-260
12.0 mm	160 mm	1	4652-12-160
12.0 mm	160 mm	1	4652-12-160-10P
12.0 mm	210 mm	1	4652-12-210
12.0 mm	210 mm	1	4652-12-210-10P
12.0 mm	260 mm	1	4652-12-260
12.0 mm	310 mm	1	4652-12-310



Ø	L		
12.0 mm	450 mm	1	4652-12-450
12.0 mm	600 mm	1	4652-12-600
12.0 mm	1000 mm	1	4652-12-1000
13.0 mm	310 mm	1	4652-13-310
14.0 mm	160 mm	1	4652-14-160
14.0 mm	210 mm	1	4652-14-210
14.0 mm	260 mm	1	4652-14-260
14.0 mm	310 mm	1	4652-14-310
14.0 mm	450 mm	1	4652-14-450
14.0 mm	600 mm	1	4652-14-600
14.0 mm	1000 mm	1	4652-14-1000
15.0 mm	260 mm	1	4652-15-260
16.0 mm	210 mm	1	4652-16-210
16.0 mm	260 mm	1	4652-16-260
16.0 mm	310 mm	1	4652-16-310
16.0 mm	450 mm	1	4652-16-450
16.0 mm	600 mm	1	4652-16-600
16.0 mm	1000 mm	1	4652-16-1000
18.0 mm	200 mm	1	4652-18-200
18.0 mm	300 mm	1	4652-18-300
18.0 mm	450 mm	1	4652-18-450
18.0 mm	1000 mm	1	4652-18-1000
20.0 mm	200 mm	1	4652-20-200
20.0 mm	300 mm	1	4652-20-300
20.0 mm	450 mm	1	4652-20-450
20.0 mm	600 mm	1	4652-20-600
20.0 mm	1000 mm	1	4652-20-1000
22.0 mm	250 mm	1	4652-22-250
22.0 mm	450 mm	1	4652-22-450
22.0 mm	600 mm	1	4652-22-600
22.0 mm	1000 mm	1	4652-22-1000
24.0 mm	250 mm	1	4652-24-250
24.0 mm	450 mm	1	4652-24-450
25.0 mm	250 mm	1	4652-25-250
25.0 mm	450 mm	1	4652-25-450
25.0 mm	1000 mm	1	4652-25-1000
26.0 mm	250 mm	1	4652-26-250
26.0 mm	450 mm	1	4652-26-450

Drill Set for Reinforced Concrete SDS + 2C - 7 pcs



4652-SET-7



7

1 4652-SET-7

4652-5-110, 4652-6-110, 4652-8-110,
4652-6-160, 4652-8-160, 4652-10-160,
4652-12-160



Drill Bits for Concrete with Carbide Tip



4641

Ø	L		
3.0 mm	60 mm	1	4641-3-60
4.0 mm	75 mm	1	4641-4-75
5.0 mm	85 mm	1	4641-5-85
5.0 mm	150 mm	1	4641-5-150
5.5 mm	85 mm	1	4641-5.5-85
6.0 mm	100 mm	1	4641-6-100
6.0 mm	150 mm	1	4641-6-150
6.0 mm	400 mm	1	4641-6-400
6.5 mm	100 mm	1	4641-6.5-100
7.0 mm	100 mm	1	4641-7-100
8.0 mm	120 mm	1	4641-8-120
8.0 mm	200 mm	1	4641-8-200
8.0 mm	400 mm	1	4641-8-400
9.0 mm	120 mm	1	4641-9-120
10.0 mm	120 mm	1	4641-10-120
10.0 mm	200 mm	1	4641-10-200
10.0 mm	400 mm	1	4641-10-400
10.0 mm	600 mm	1	4641-10-600
11.0 mm	150 mm	1	4641-11-150
12.0 mm	150 mm	1	4641-12-150
12.0 mm	200 mm	1	4641-12-200
12.0 mm	400 mm	1	4641-12-400
12.0 mm	600 mm	1	4641-12-600
13.0 mm	150 mm	1	4641-13-150
14.0 mm	150 mm	1	4641-14-150
14.0 mm	400 mm	1	4641-14-400
14.0 mm	600 mm	1	4641-14-600
16.0 mm	150 mm	1	4641-16-150
16.0 mm	400 mm	1	4641-16-400

Drill Set for Reinforced Concrete SDS + 2C - 5 pcs



4652-SET-5



5

1 4652-SET-5

4652-5-110, 4652-6-110, 4652-6-160,
4652-8-160, 4652-10-160



Ø	L		
16.0 mm	600 mm	1	4641-16-600
18.0 mm	400 mm	1	4641-18-400
18.0 mm	600 mm	1	4641-18-600
20.0 mm	400 mm	1	4641-20-400
20.0 mm	600 mm	1	4641-20-600
22.0 mm	400 mm	1	4641-22-400
24.0 mm	400 mm	1	4641-24-400
25.0 mm	400 mm	1	4641-25-400

Drill Set for Concrete with Carbide Tip - 5 Pcs



4641-PB



5

185 g

1 4641-PB

4641-4-75, 4641-5-85, 4641-6-100, 4641-8-120,
4641-10-120

Drill Set for Masonry with Carbide Tip - 5 pcs



4643-PB



5

150 g

1 4643-PB

4mm, 5mm, 6mm, 8mm and 10mm

SDS Max Chisel Drill Bits for Reinforced Concrete



4659



Ø	L	Icons
- mm	280 mm	1 4659-POINT-28
- mm	400 mm	1 4659-POINT-40
- mm	600 mm	1 4659-POINT-60
24.0 mm	280 mm	1 4659-FLAT-28
24.0 mm	400 mm	1 4659-FLAT-40
24.0 mm	600 mm	1 4659-FLAT-60
80.0 mm	300 mm	1 4659-WIDE-30-8
50.0 mm	360 mm	1 4659-WIDE-36-5
50.0 mm	300 mm	1 4659-TILE-30-5
80.0 mm	300 mm	1 4659-TILE-30-8

SDS+ Chisel Drill Bits for Reinforced Concrete



4655



Ø	L	Icons
20.0 mm	250 mm	1 4655-FLAT-250
22.0 mm	240 mm	1 4655-HOLLOW-240
- mm	250 mm	1 4655-POINT-250
32.0 mm	200 mm	1 4655-SLOT-25032
38.0 mm	200 mm	1 4655-TILE-20040
38.0 mm	200 mm	1 4655-WIDE-20040
22.0 mm	250 mm	1 4655-WING-C-250

Cobalt HSS-E Drill Bits for Metal



4411



Ø	L	Icons
1.00 mm	34 mm	1 4411-1.00
1.50 mm	40 mm	1 4411-1.50
2.00 mm	49 mm	1 4411-2.00
2.50 mm	57 mm	1 4411-2.50
3.00 mm	61 mm	1 4411-3.00
3.25 mm	65 mm	1 4411-3.25
3.30 mm	65 mm	1 4411-3.30
3.50 mm	70 mm	1 4411-3.50
4.00 mm	75 mm	1 4411-4.00
4.20 mm	75 mm	1 4411-4.20
4.25 mm	75 mm	1 4411-4.25
4.50 mm	80 mm	1 4411-4.50
5.00 mm	86 mm	1 4411-5.00
5.50 mm	93 mm	1 4411-5.50
6.00 mm	93 mm	1 4411-6.00
6.50 mm	101 mm	1 4411-6.50
6.80 mm	109 mm	1 4411-6.80

Ø	L	Icons
7.00 mm	109 mm	1 4411-7.00
7.50 mm	109 mm	1 4411-7.50
8.00 mm	117 mm	1 4411-8.00
8.50 mm	117 mm	1 4411-8.50
9.00 mm	125 mm	1 4411-9.00
9.50 mm	125 mm	1 4411-9.50
10.00 mm	125 mm	1 4411-10.00
10.20 mm	133 mm	1 4411-10.20
10.50 mm	133 mm	1 4411-10.50
11.00 mm	142 mm	1 4411-11.00
11.50 mm	142 mm	1 4411-11.50
12.00 mm	151 mm	1 4411-12.00
12.50 mm	151 mm	1 4411-12.50
13.00 mm	151 mm	1 4411-13.00

Size 1 mm up to 4 mm, two drills in each tube

Cobalt HSS-E Drill Bits for Metal with Industrial Pack



4511

Ø	L	Icons
0.50 mm	22 mm	1 4511-0.50-10P
0.75 mm	28 mm	1 4511-0.75-10P
1.00 mm	34 mm	1 4511-1.00-10P
1.50 mm	40 mm	1 4511-1.50-10P
1.75 mm	46 mm	1 4511-1.75-10P
2.00 mm	49 mm	1 4511-2.00-10P
2.50 mm	57 mm	1 4511-2.50-10P
2.70 mm	61 mm	1 4511-2.70-10P
2.90 mm	61 mm	1 4511-2.90-10P
3.00 mm	61 mm	1 4511-3.00-10P
3.10 mm	65 mm	1 4511-3.10-10P
3.25 mm	65 mm	1 4511-3.25-10P
3.30 mm	65 mm	1 4511-3.30-10P
3.50 mm	70 mm	1 4511-3.50-10P
3.80 mm	75 mm	1 4511-3.80-10P
4.00 mm	75 mm	1 4511-4.00-10P
4.20 mm	75 mm	1 4511-4.20-10P
4.50 mm	80 mm	1 4511-4.50-10P
4.80 mm	86 mm	1 4511-4.80-10P
5.00 mm	86 mm	1 4511-5.00-10P
5.20 mm	86 mm	1 4511-5.20-10P
5.50 mm	93 mm	1 4511-5.50-10P
6.00 mm	93 mm	1 4511-6.00-10P
6.20 mm	101 mm	1 4511-6.20-10P
6.50 mm	101 mm	1 4511-6.50-10P
6.80 mm	109 mm	1 4511-6.80-10P
7.00 mm	109 mm	1 4511-7.00-10P
7.20 mm	109 mm	1 4511-7.20-10P
7.50 mm	109 mm	1 4511-7.50-10P
7.80 mm	117 mm	1 4511-7.80-10P
8.00 mm	117 mm	1 4511-8.00-10P
8.50 mm	117 mm	1 4511-8.50-10P
8.60 mm	125 mm	1 4511-8.60-10P
8.80 mm	125 mm	1 4511-8.80-10P
9.00 mm	125 mm	1 4511-9.00-10P
9.20 mm	125 mm	1 4511-9.20-10P
9.50 mm	125 mm	1 4511-9.50-10P
9.60 mm	133 mm	1 4511-9.60-10P
10.00 mm	133 mm	1 4511-10.00-5P
10.20 mm	133 mm	1 4511-10.20-5P
10.30 mm	133 mm	1 4511-10.30-5P
10.50 mm	133 mm	1 4511-10.50-5P
10.80 mm	142 mm	1 4511-10.80-5P
11.00 mm	142 mm	1 4511-11.00-5P
11.50 mm	142 mm	1 4511-11.50-5P
12.00 mm	151 mm	1 4511-12.00-5P
12.50 mm	151 mm	1 4511-12.50-5P
12.80 mm	151 mm	1 4511-12.80-5P
13.00 mm	151 mm	1 4511-13.00-5P

Ø	L	Icons
13.50 mm	160 mm	1 4511-13.50-1P
14.00 mm	160 mm	1 4511-14.00-1P
14.50 mm	169 mm	1 4511-14.50-1P
15.00 mm	169 mm	1 4511-15.00-1P
15.50 mm	169 mm	1 4511-15.50-1P
16.00 mm	178 mm	1 4511-16.00-1P
16.50 mm	184 mm	1 4511-16.50-1P
17.00 mm	184 mm	1 4511-17.00-1P
17.50 mm	191 mm	1 4511-17.50-1P
18.00 mm	191 mm	1 4511-18.00-1P
18.50 mm	198 mm	1 4511-18.50-1P
19.00 mm	198 mm	1 4511-19.00-1P
19.50 mm	205 mm	1 4511-19.50-1P
20.00 mm	205 mm	1 4511-20.00-1P

Cobalt HSS-E Drill Bit Set for Metal - 6 Pcs



4511-SET-6

6	150 g	1 4511-SET-6
---	-------	--------------

4411-2.00, 4411-3.00, 4411-4.00, 4411-5.00, 4411-6.00, 4411-8.00

Cobalt HSS-E Drill Bit Set for Metal - 19 Pcs



4511-SET-19

19	600 g	1 4511-SET-19
----	-------	---------------

1.0 to 10.0 mm x 0.5 mm

4411-1.00, 4411-1.50, 4411-2.00, 4411-2.50, 4411-3.00, 4411-3.50, 4411-4.00, 4411-4.50, 4411-5.00, 4411-5.50, 4411-6.00, 4411-6.50, 4411-7.00, 4411-7.50, 4411-8.00, 4411-8.50, 4411-9.00, 4411-9.50, 4411-10.00



Cobalt HSS-E Drill Bit Set for Metal - 25 Pcs



4511-SET-25



25 1200 g 1 4511-SET-25

1x 1.0, 1.5; 2.0; 2.5; 3.0; 3.5; 4.0; 4.5; 5.0; 5.5; 6.0; 6.5; 7.0; 7.5; 8.0; 8.5; 9.0; 9.5; 10.0; 10.5; 11.0; 11.5; 12; 12.5; 13.0mm



HSS-G Drill Bits for Metal



4413

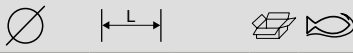

Ø	L		
1.00 mm	34 mm	1	4413-1.00
1.50 mm	40 mm	1	4413-1.50
2.00 mm	49 mm	1	4413-2.00
2.50 mm	57 mm	1	4413-2.50
3.00 mm	61 mm	1	4413-3.00
3.25 mm	65 mm	1	4413-3.25
3.30 mm	65 mm	1	4413-3.30
3.50 mm	70 mm	1	4413-3.50
4.00 mm	75 mm	1	4413-4.00
4.20 mm	75 mm	1	4413-4.20
4.25 mm	75 mm	1	4413-4.25
4.50 mm	80 mm	1	4413-4.50
5.00 mm	86 mm	1	4413-5.00
5.50 mm	93 mm	1	4413-5.50
6.00 mm	93 mm	1	4413-6.00
6.50 mm	101 mm	1	4413-6.50
6.80 mm	109 mm	1	4413-6.80
7.00 mm	109 mm	1	4413-7.00
7.50 mm	109 mm	1	4413-7.50
8.00 mm	117 mm	1	4413-8.00
8.50 mm	117 mm	1	4413-8.50
9.00 mm	125 mm	1	4413-9.00
9.50 mm	125 mm	1	4413-9.50
10.00 mm	133 mm	1	4413-10.00
10.20 mm	133 mm	1	4413-10.20
10.50 mm	133 mm	25	4413-10.50
11.00 mm	142 mm	1	4413-11.00
11.50 mm	142 mm	25	4413-11.50
12.00 mm	151 mm	1	4413-12.00
12.50 mm	151 mm	25	4413-12.50
13.00 mm	151 mm	1	4413-13.00

Size 1 mm up to 4 mm, two drills in each tube



HSS-G Drill Bits for Metal with Industrial Pack



4513



Ø	L		
1.00 mm	34 mm	1	4513-1.00-10P
1.50 mm	40 mm	1	4513-1.50-10P
1.75 mm	46 mm	1	4513-1.75-10P
2.00 mm	49 mm	1	4513-2.00-10P
2.50 mm	57 mm	1	4513-2.50-10P
2.70 mm	61 mm	1	4513-2.70-10P
2.90 mm	61 mm	1	4513-2.90-10P
3.00 mm	61 mm	1	4513-3.00-10P
3.10 mm	65 mm	1	4513-3.10-10P
3.25 mm	65 mm	1	4513-3.25-10P
3.30 mm	65 mm	1	4513-3.30-10P
3.50 mm	70 mm	1	4513-3.50-10P
3.80 mm	75 mm	1	4513-3.80-10P
4.00 mm	75 mm	1	4513-4.00-10P
4.20 mm	75 mm	1	4513-4.20-10P
4.50 mm	80 mm	1	4513-4.50-10P
4.80 mm	86 mm	1	4513-4.80-10P
5.00 mm	86 mm	1	4513-5.00-10P
5.20 mm	86 mm	1	4513-5.20-10P
5.50 mm	93 mm	1	4513-5.50-10P
6.00 mm	93 mm	1	4513-6.00-10P
6.20 mm	101 mm	1	4513-6.20-10P
6.50 mm	101 mm	1	4513-6.50-10P
6.80 mm	109 mm	1	4513-6.80-10P
7.00 mm	109 mm	1	4513-7.00-10P
7.20 mm	109 mm	1	4513-7.20-10P
7.50 mm	109 mm	1	4513-7.50-10P
7.80 mm	117 mm	1	4513-7.80-10P
8.00 mm	117 mm	1	4513-8.00-10P
8.50 mm	117 mm	1	4513-8.50-10P
8.60 mm	125 mm	1	4513-8.60-10P
8.80 mm	125 mm	1	4513-8.80-10P
9.00 mm	125 mm	1	4513-9.00-10P
9.20 mm	125 mm	1	4513-9.20-10P
9.50 mm	125 mm	1	4513-9.50-10P
9.60 mm	133 mm	1	4513-9.60-10P
10.00 mm	133 mm	1	4513-10.00-5P
10.20 mm	133 mm	1	4513-10.20-5P
10.30 mm	133 mm	1	4513-10.30-5P
10.50 mm	133 mm	1	4513-10.50-5P
10.80 mm	142 mm	1	4513-10.80-5P
11.00 mm	142 mm	1	4513-11.00-5P
11.50 mm	142 mm	1	4513-11.50-5P
12.00 mm	151 mm	1	4513-12.00-5P
12.50 mm	151 mm	1	4513-12.50-5P
12.80 mm	151 mm	1	4513-12.80-5P
13.00 mm	151 mm	1	4513-13.00-5P
13.50 mm	160 mm	1	4513-13.50-1P
14.00 mm	160 mm	1	4513-14.00-1P
14.50 mm	169 mm	1	4513-14.50-1P
15.00 mm	169 mm	1	4513-15.00-1P
15.50 mm	178 mm	1	4513-15.50-1P
16.00 mm	178 mm	1	4513-16.00-1P
16.50 mm	184 mm	1	4513-16.50-1P
17.00 mm	184 mm	1	4513-17.00-1P
17.50 mm	191 mm	1	4513-17.50-1P
18.00 mm	191 mm	1	4513-18.00-1P

Ø	L		
18.50 mm	198 mm	1	4513-18.50-1P
19.00 mm	198 mm	1	4513-19.00-1P
19.50 mm	205 mm	1	4513-19.50-1P
20.00 mm	205 mm	1	4513-20.00-1P

HSS-G Drill Bit Set for Metal - 6 Pcs



4513-SET-6



6 150 g 1 4513-SET-6

2.0 to 8.0 mm x 1.0 mm (excl. 7.0 mm)

4413-2.00, 4413-3.00, 4413-4.00, 4413-5.00, 4413-6.00, 4413-8.00



HSS-G Drill Bit Set for Metal - 19 Pcs



4513-SET-19



19 600 g 1 4513-SET-19

4413-1.00, 4413-1.50, 4413-2.00, 4413-2.50, 4413-3.00, 4413-3.50, 4413-4.00, 4413-4.50, 4413-5.00, 4413-5.50, 4413-6.00, 4413-6.50, 4413-7.00, 4413-7.50, 4413-8.00, 4413-8.50, 4413-9.00, 4413-9.50, 4413-10.00



HSS-G Drill Bit Set for Metal - 25 Pcs



4513-SET-25

25 1200 g 1 4513-SET-25

1x 1.0; 1.5; 2.0; 2.5; 3.0; 3.5; 4.0; 4.5; 5.0; 5.5; 6.0; 6.5; 7.0; 7.5; 8.0; 8.5; 9.0; 9.5; 10.0; 10.5; 11.0; 11.5; 12; 12.5; 13.0 mm



Ø	L	Icon	Icon
12.50 mm	151 mm	1	4415-12.50
13.00 mm	151 mm	1	4415-13.00
13.50 mm	160 mm	1	4415-13.50
14.00 mm	160 mm	1	4415-14.00
14.50 mm	169 mm	1	4415-14.50
15.00 mm	169 mm	1	4415-15.00
15.50 mm	178 mm	1	4415-15.50
16.00 mm	178 mm	1	4415-16.00
16.50 mm	184 mm	1	4415-16.50
17.00 mm	184 mm	1	4415-17.00
17.50 mm	191 mm	1	4415-17.50
18.00 mm	191 mm	1	4415-18.00
18.50 mm	198 mm	1	4415-18.50
19.00 mm	198 mm	1	4415-19.00
19.50 mm	205 mm	1	4415-19.50
20.00 mm	205 mm	1	4415-20.00

Size 1 mm up to 4 mm, two drills in each tube

HSS-R Drill Bits for Metal with Industrial Pack



4515

Ø	L	Icon	Icon
1.00 mm	34 mm	1	4515-1.00-10P
1.50 mm	40 mm	1	4515-1.50-10P
2.00 mm	49 mm	1	4515-2.00-10P
2.50 mm	57 mm	1	4515-2.50-10P
3.00 mm	61 mm	1	4515-3.00-10P
3.25 mm	65 mm	1	4515-3.25-10P
3.50 mm	70 mm	1	4515-3.50-10P
4.00 mm	75 mm	1	4515-4.00-10P
4.25 mm	75 mm	1	4515-4.25-10P
4.50 mm	80 mm	1	4515-4.50-10P
5.00 mm	86 mm	1	4515-5.00-10P
5.50 mm	93 mm	1	4515-5.50-10P
6.00 mm	93 mm	1	4515-6.00-10P
6.50 mm	101 mm	1	4515-6.50-10P
7.00 mm	109 mm	1	4515-7.00-10P
7.50 mm	109 mm	1	4515-7.50-10P
8.00 mm	117 mm	1	4515-8.00-10P
8.50 mm	117 mm	1	4515-8.50-10P
9.00 mm	125 mm	1	4515-9.00-10P
9.50 mm	125 mm	1	4515-9.50-10P
10.00 mm	133 mm	1	4515-10.00-10P
10.50 mm	133 mm	1	4515-10.50-5P
11.00 mm	142 mm	1	4515-11.00-5P
11.50 mm	142 mm	1	4515-11.50-5P
12.00 mm	151 mm	1	4515-12.00-5P
12.50 mm	151 mm	1	4515-12.50-5P
13.00 mm	151 mm	1	4515-13.00-5P

HSS-R Drill Bits for Metal



4415

Ø	L	Icon	Icon
1.00 mm	34 mm	1	4415-1.00
1.50 mm	40 mm	1	4415-1.50
2.00 mm	49 mm	1	4415-2.00
2.50 mm	57 mm	1	4415-2.50
3.00 mm	61 mm	1	4415-3.00
3.25 mm	65 mm	1	4415-3.25
3.50 mm	70 mm	1	4415-3.50
4.00 mm	75 mm	1	4415-4.00
4.25 mm	75 mm	1	4415-4.25
4.50 mm	80 mm	1	4415-4.50
5.00 mm	86 mm	1	4415-5.00
5.50 mm	93 mm	1	4415-5.50
6.00 mm	93 mm	1	4415-6.00
6.50 mm	101 mm	1	4415-6.50
7.00 mm	109 mm	1	4415-7.00
7.50 mm	109 mm	1	4415-7.50
8.00 mm	117 mm	1	4415-8.00
8.50 mm	117 mm	1	4415-8.50
9.00 mm	125 mm	1	4415-9.00
10.00 mm	125 mm	1	4415-10.00
10.50 mm	133 mm	1	4415-10.50
11.00 mm	142 mm	1	4415-11.00
11.50 mm	142 mm	1	4415-11.50
12.00 mm	151 mm	1	4415-12.00



HSS-R Drill Bit Set for Metal - 19 Pcs



4515-SET-19

19 600 g 1 4515-SET-19

1x 1.0mm; 1.5mm; 2.0mm; 2.5mm; 3.0mm; 3.5mm; 4.0mm; 4.5mm; 5.0mm; 5.5mm; 6.0mm; 6.5mm; 7mm; 7.5mm; 8mm; 8.5mm; 9.0mm; 9.5mm; 10mm



HSS-R Drill Bit Set for Metal - 25 pcs



4515-SET-25

25 1200 g 1 4515-SET-25

1x 1.0; 1.5; 2.0; 2.5; 3.0; 3.5; 4.0; 4.5; 5.0; 5.5; 6.0; 6.5; 7; 7.5; 8; 8.5; 9.0; 9.5; 10; 10.5; 11; 11.5; 12; 12.5; 13 mm



Step Drills for Metal Sheet 4 mm-12 mm



228-SD

6.35 mm 4-5-6-7-8-9-10-11-12 mm 24 228-SD



Step Drills for Metal sheet 4 mm-22 mm



229-SD

10 mm	4-6-8-10-12-14-16-18-20-22 mm	24	229-SD

Step Drills for Metal Sheet 6.5 mm-40.5 mm



234-SD

10 mm	6.5-8.5-10.5-12.5-16.5-20.5-25.5-29-32.5-36.5-40.5 mm	25	234-SD

Auger Drill Bits for Wood



9626

6.0 mm	1	9626-6
7.0 mm	1	9626-7
8.0 mm	1	9626-8
9.0 mm	1	9626-9
10.0 mm	1	9626-10
11.0 mm	1	9626-11
12.0 mm	1	9626-12
13.0 mm	1	9626-13
14.0 mm	1	9626-14
15.0 mm	1	9626-15
16.0 mm	1	9626-16
18.0 mm	1	9626-18
20.0 mm	1	9626-20
22.0 mm	1	9626-22
23.0 mm	1	9626-23
24.0 mm	1	9626-24
25.0 mm	1	9626-25
26.0 mm	1	9626-26
28.0 mm	1	9626-28
30.0 mm	1	9626-30
32.0 mm	1	9626-32
35.0 mm	1	9626-35
6.0 mm	1	9627-6-460
8.0 mm	1	9627-8-460
10.0 mm	1	9627-10-460
12.0 mm	1	9627-12-460
14.0 mm	1	9627-14-460
16.0 mm	1	9627-16-460
18.0 mm	1	9627-18-460
20.0 mm	1	9627-20-460
22.0 mm	1	9627-22-460
24.0 mm	1	9627-24-460
26.0 mm	1	9627-26-460
28.0 mm	1	9627-28-460
30.0 mm	1	9627-30-460
32.0 mm	1	9627-32-460

Step Drills for Metal sheet 5 mm-35 mm



230-SD

12.7 mm	5-13-15-17-19-21-23-25-27-29-31-33-35 mm	25	230-SD

HSS Step Drill Set - 3 Pcs



228-SET

3	560 g	1	228-SET-SD

228-SD

229-SD

230-SD

Step Drills for Metal Sheet 6 mm-37 mm



232-SD

10 mm	6-9-12.5-15.2-18.6-20.4-22.5-26-28.3-30.5-34-37 mm	1	232-SD

HSS-G Countersink Drill Bits for Metal



4435

12.4 mm	56 mm	1	4435-12.4

Auger Bit Set - 6 Pcs



SB-9526/S6

6	20	SB-9526/S6

9526-10, 9526-13, 9526-19, 9526-22, 9526-25

9526-16

Flat Drill Bits for Wood



9629

Ø	L		
6.0 mm	152 mm	1	9629-6
8.0 mm	152 mm	1	9629-8
10.0 mm	152 mm	1	9629-10
12.0 mm	152 mm	1	9629-12
13.0 mm	152 mm	1	9629-13
14.0 mm	152 mm	1	9629-14
16.0 mm	152 mm	1	9629-16
17.0 mm	152 mm	1	9629-17
18.0 mm	152 mm	1	9629-18
19.0 mm	152 mm	1	9629-19
20.0 mm	152 mm	1	9629-20
22.0 mm	152 mm	1	9629-22
24.0 mm	152 mm	1	9629-24
25.0 mm	152 mm	1	9629-25
26.0 mm	152 mm	1	9629-26
28.0 mm	152 mm	1	9629-28
30.0 mm	152 mm	1	9629-30
32.0 mm	152 mm	1	9629-32
35.0 mm	152 mm	1	9629-35
36.0 mm	152 mm	1	9629-36
38.0 mm	152 mm	1	9629-38
40.0 mm	152 mm	1	9629-40
6.0 mm	400 mm	1	9631-6-400
8.0 mm	400 mm	1	9631-8-400
10.0 mm	400 mm	1	9631-10-400
12.0 mm	400 mm	1	9631-12-400
13.0 mm	400 mm	1	9631-13-400
14.0 mm	400 mm	1	9631-14-400
16.0 mm	400 mm	1	9631-16-400
18.0 mm	400 mm	1	9631-18-400
19.0 mm	400 mm	1	9631-19-400
20.0 mm	400 mm	1	9631-20-400
22.0 mm	400 mm	1	9631-22-400
24.0 mm	400 mm	1	9631-24-400
25.0 mm	400 mm	1	9631-25-400
28.0 mm	400 mm	1	9631-28-400
30.0 mm	400 mm	1	9631-30-400
32.0 mm	400 mm	1	9631-32-400
35.0 mm	400 mm	1	9631-35-400
38.0 mm	400 mm	1	9631-38-400

Flat Drill Bit Set for Wood - 8 pcs



9629-SET-8

X	g		
8	630 g	12	9629-SET-8

9629-12, 9629-16, 9629-18, 9629-20, 9629-22, 9629-25, 9629-28, 9629-32



Speed Cut Drill Bit Set for Wood - 6 Pcs



9656-SET-6

X	g		
6	720 g	1	9656-SET-6

Brad Point Drill Bits for Wood



9646

Ø			
3 mm		1	9646-3
4 mm		1	9646-4
5 mm		1	9646-5
6 mm		1	9646-6
7 mm		1	9646-7
8 mm		1	9646-8
9 mm		1	9646-9
10 mm		1	9646-10
11 mm		1	9646-11
12 mm		1	9646-12
13 mm		1	9646-13
14 mm		1	9646-14
15 mm		1	9646-15
16 mm		1	9646-16
18 mm		1	9646-18
20 mm		1	9646-20
6 mm		1	9646-6-250
8 mm		1	9646-8-250
10 mm		1	9646-10-250
12 mm		1	9646-12-250

Brad Point Drill Bit Set for Wood - 5 pcs



9646-SET-5

X	g		
5	110 g	1	9646-SET-5

9646-4, 9646-5, 9646-6, 9646-8, 9646-10

Brad Point Drill Bit Set for Wood - 8 pcs



9646-SET-8

X	g		
8	230 g	1	9646-SET-8

9646-3, 9646-4, 9646-5, 9646-6, 9646-7, 9646-8, 9646-9, 9646-10

Expansive Drill Bits for Wood



9528

Ø			
15-45 mm		10	9528-MD-15-45



Drill Bits for Tiles



4626

Ø	L	Icons	Part No.
4 mm	58 mm		1 4626-4.0
5 mm	58 mm		1 4626-5.0
6 mm	58 mm		1 4626-6.0
8 mm	78 mm		1 4626-8.0
10 mm	98 mm		1 4626-10.0

Extension Shaft 305 mm 1/4" Quick-Change



9625-6.35QC

Ø	L	Icons	Part No.
6.35 mm	305 mm		1 9625-6.35QC

1/4" Diamond Torsion Screwdriver Bits for Phillips Dry Wall Head Screws 25 mm



63D/PH2G

Icons	Part No.
	5 PH2G
	1 63D/PH2G

Multi-Purpose Drill Bits for Tiles, Natural Stone, Wood and Plastic



4629

Ø	L	Icons	Part No.
4.0 mm	75 mm		1 4629-4.0
5.0 mm	85 mm		1 4629-5.0
6.0 mm	100 mm		1 4629-6.0
8.0 mm	120 mm		1 4629-8.0
10.0 mm	120 mm		1 4629-10.0

Extension Shafts 330 mm



9525

Ø	Part No.
7 mm	1 9525-7
10 mm	1 9525-10

1/4" Diamond Torsion Screwdriver Bits for Pozidriv Head Screws 25 mm



63D/PZ

Icons	Part No.
	5 1 63D/PZ1
	5 2 1 63D/PZ2

Drill Set Multi-Purpose with Carbide Tip - 5 pcs



4629-SET-5

Icons	Part No.
	5 165 g 10 4629-SET-5

4629-8.0, 4629-10.0, 4629-4.0, 4629-5.0, 4629-6.0

SCREWDRIVER BITS

1/4" Diamond Torsion Screwdriver Bits for Phillips Head Screws 25 mm



63D/PH

Icons	Part No.
	5 3 1 63D/PH3

1/4" Diamond Torsion Screwdriver Bits for TORX® Head Screws 25 mm



63D/T

Icons	Part No.
	5 T10 1 63D/T10
	5 T15 1 63D/T15
	5 T40 1 63D/T40

1/4" Diamond Torsion Screwdriver Bits for Pozidriv Head Screws 50 mm - 5 Pcs/ Plastic Box



63D/50PZ

5	1	1	63D/50PZ1	
5	2	1	63D/50PZ2	
5	3	1	63D/50PZ3	

1/4" Tin Torsion Screwdriver Bits for Pozidriv Head Screws 25 mm



62TIN/PZ

10	1	1	62TIN/PZ1
10	2	1	62TIN/PZ2
10	3	1	62TIN/PZ3

1/4" Tin Torsion Screwdriver Bits for Pozidriv Head Screws 50 mm



62TIN/50PZ

5	1	1	62TIN/50PZ1
5	2	1	62TIN/50PZ2
5	3	1	62TIN/50PZ3

1/4" Diamond Torsion Screwdriver Bits Set with Bit Holder for Phillips/Pozidriv/TORX® Head Screws



63D/7

7	20 x 50 x 80 mm	1	63D/7-1

63D/PH2		
63D/PZ2		
63D/T10, 63D/T15, 63D/T25, 63D/T30		

1/4" Tin Torsion Screwdriver Bits for TORX® Head Screws 25 mm



62TIN/T

10	T15	1	62TIN/T15
10	T20	1	62TIN/T20
10	T25	1	62TIN/T25
10	T30	1	62TIN/T30

1/4" Tin Torsion Bit Set for Phillips/Pozidriv/TORX® Head Screws



62TIN/7

7	22 x 65 x 75 mm	1	62TIN/7-1

62TIN/PH2		
62TIN/PZ2		
62TIN/T15, 62TIN/T20, 62TIN/T25, 62TIN/T30		

1/4" Tin Torsion Screwdriver Bits for Phillips Head Screws 25 mm



62TIN/PH

10	1	1	62TIN/PH1

1/4" Tin Torsion Screwdriver Bits for Phillips Head Screws 50 mm



62TIN/50PH

5	1	1	62TIN/50PH1
5	3	1	62TIN/50PH3

1/4" ACR Torsion Screwdriver Bits for Phillips Head Screws 25 mm



64A/PH

10	1	1	64A/PH1
10	3	1	64A/PH3



1/4" ACR Torsion Screwdriver Bits for Pozidriv Head Screws 25 mm



64A/PZ

Icon	Icon	Icon	Icon
10	1	1	64A/PZ1
10	3	1	64A/PZ3

1/4" Torsion Screwdriver Bits for Phillips Head Screws 25 mm



60T/PH

Icon	Icon	Icon	Icon
10	1	1	60T/PH1
10	2	1	60T/PH2
10	3	1	60T/PH3

1/4" Torsion Screwdriver Bits for Pozidriv Head Screws 25 mm



60T/PZ

Icon	Icon	Icon	Icon
10	1	1	60T/PZ1
10	2	1	60T/PZ2
10	3	1	60T/PZ3

1/4" Torsion Screwdriver Bits for TORX® Head Screws 25 mm



60T/T

Icon	Icon	Icon	Icon
10	T7	1	60T/T7
10	T9	1	60T/T9
10	T15	1	60T/T15
10	T20	1	60T/T20
10	T25	1	60T/T25
10	T27	1	60T/T27
10	T40	1	60T/T40

1/4" Torsion Bit Set for Phillips/Pozidriv/TORX® head screws - 7 Pcs



60T/7

Icon	Icon	Icon	Icon
7	22 x 65 x 75 mm	1	60T/7-1

60T/PH2



60T/PZ2



60T/T10, 60T/T15, 60T/T20, 60T/T30



1/4" Torsion Bit Set for Phillips/TORX® head screws - 17 Pcs



60T/17

Icon	Icon	Icon	Icon
17	27 x 73 x 82 mm	1	60T/17-1

60T/PH1, 60T/PH2



60T/T7, 60T/T8, 60T/T9, 60T/T10, 60T/T15x 2, 60T/T20x 2, 60T/T25x 2, 60T/T27, 60T/T30x 2, 60T/T40



1/4" Torsion Bit Set for Slotted/Phillips/Pozidriv/TORX®/Hex head screws - 31 Pcs



60T/31

Icon	Icon	Icon	Icon
31	42 x 65 x 110 mm	1	60T/31-1

59S/0.6-4.5, 59S/0.8-5.5



60T/PH1, 60T/PH2x 3, 60T/PH3



59S/PH2Gx 2



60T/PZ1, 60T/PZ2x 3, 60T/PZ3



60T/T10, 60T/T15x 3, 60T/T20x 3, 60T/T25x 2, 60T/T27, 60T/T30x 2



59S/H3, 59S/H4, 59S/H5, 59S/H6



1/4" Extra Hard Torsion Screwdriver Bits for Phillips Head Screws 25 mm



61H/PH

Icon	Icon	Icon	Icon
10	1	1	61H/PH1
10	2	1	61H/PH2
5	3	1	61H/PH3

1/4" Extra Hard Torsion Screwdriver Bits for Phillips Head Screws 50 mm



61H/50PH

5	1	1	61H/50PH1

1/4" Extra Hard Torsion Screwdriver Bits for TORX® Head Screws 50 mm



61H/50T

5	T10	1	61H/50T10
5	T15	1	61H/50T15
5	T25	1	61H/50T25
5	T30	1	61H/50T30

1/4" Impact Torsion Screwdriver Bits for Pozidriv Head Screws 25 mm



66IM/PZ

2	1	1	66IM/PZ1-2P
2	2	1	66IM/PZ2-2P
2	3	1	66IM/PZ3-2P

1/4" Extra Hard Torsion Screwdriver Bits for Pozidriv Head Screws 25 mm



61H/PZ

5	3	1	61H/PZ3

1/4" Extra Hard Torsion Screwdriver Bits for TORX® Head Screws 25 mm



61H/T

10	T10	1	61H/T10
10	T15	1	61H/T15
10	T20	1	61H/T20
10	T25	1	61H/T25
5	T40	1	61H/T40

1/4" Impact Torsion Screwdriver Bits for TORX® Head Screws 25 mm



66IM/T

2	T10	1	66IM/T10C-2P
2	T15	1	66IM/T15C-2P
2	T20	1	66IM/T20C-2P
2	T25	1	66IM/T25C-2P
2	T27	1	66IM/T27C-2P
2	T20	1	66IM/T30C-2P
2	T40	1	66IM/T40C-2P

1/4" Extra Hard Torsion Screwdriver Bits for Pozidriv Head Screws 50 mm



61H/50PZ

5	1	1	61H/50PZ1
5	2	1	61H/50PZ2
5	3	1	61H/50PZ3

1/4" Impact Torsion Screwdriver Bits for Phillips Head Screws 25 mm



66IM/PH

2	1	1	66IM/PH1-2P
2	2	1	66IM/PH2-2P
2	3	1	66IM/PH3-2P

1/4" Impact Torsion Screwdriver Bits for Phillips Head Screws 50 mm



66IM/50PH

2	1	1	66IM/50PH1-2P
2	2	1	66IM/50PH2-2P
2	3	1	66IM/50PH3-2P



1/4" Impact Torsion Screwdriver Bits for Pozidriv Head Screws 50 mm



66IM/50PZ

Quantity	Length (mm)	Part Number
2	1	66IM/50PZ1-2P
2	2	66IM/50PZ2-2P
2	3	66IM/50PZ3-2P

1/4" Impact Torsion Screwdriver Bits for TORX® Head Screws 50 mm



66IM/50TC

Quantity	Length (mm)	Part Number
2	10	66IM/50T10C-2P
2	15	66IM/50T15C-2P
2	20	66IM/50T20C-2P
2	25	66IM/50T25C-2P
2	27	66IM/50T27C-2P
2	30	66IM/50T30C-2P
2	40	66IM/50T40C-2P

1/4" Impact Torsion Bit Set for Phillips/Pozidriv/TORX® with Soft Plastic Holder, 50 mm bits - 11 Pcs



66IM/11C-1

Quantity	Dimensions (mm)	Part Number
11	25 x 37 x 140	66IM/11C-1

66IM/PH2-2Px 2, 66IM/PH3-2P		
66IM/PZ2-2Px 2, 66IM/PZ3-2P		
66IM/T20C-2Px 2, 66IM/T25C-2P, 66IM/T30C-2P		
KMT753-QR-1P		

1/4" Impact Torsion Bit Set for Phillips/Pozidriv/TORX® with Soft Plastic Holder, 25 mm bits- 10 Pcs



66IM/10C-1

Quantity	Dimensions (mm)	Part Number
10	10 x 50 x 140	66IM/10C-1

66IM/50PH2-2Px 2, 66IM/50PH3-2P		
66IM/50PZ2-2Px 2, 66IM/50PZ3-2P		
66IM/50T20C-2Px 2, 66IM/50T25C-2P, 66IM/50T30C-2P		

1/4" Standard Screwdriver Bits for Slotted Head Screws 25 mm



59S/

Quantity	Length (mm)	Part Number
10	3.0 mm	59S/0.5-3.0
3	3.0 mm	59S/0.5-3.0-3P
10	4.0 mm	59S/0.5-4.0
3	4.0 mm	59S/0.5-4.0-3P
10	3.5 mm	59S/0.6-3.5
3	3.5 mm	59S/0.6-3.5-3P
10	4.5 mm	59S/0.6-4.5
3	4.5 mm	59S/0.6-4.5-3P
10	5.5 mm	59S/0.8-5.5
3	5.5 mm	59S/0.8-5.5-3P
10	5.5 mm	59S/1.0-5.5
3	5.5 mm	59S/1.0-5.5-3P
10	6.5 mm	59S/1.2-6.5
3	6.5 mm	59S/1.2-6.5-3P
10	8.0 mm	59S/1.2-8.0
3	8.0 mm	59S/1.2-8.0-3P
10	9.0 mm	59S/1.6-9.0
10	10 mm	59S/1.6-10
3	9.0 mm	59S/1.6-9.0-3P
3	10.0 mm	59S/1.6-10-3P

1/4" Standard Screwdriver Bits for Phillips Head Screws 25 mm



59S/PH

Quantity	Length (mm)	Part Number
10	0	59S/PH0
3	0	59S/PH0-3P
3	1	59S/PH1-3P
30	1	59S/PH1-30P
100	*1	100 59S/PH1-IP
500	1	500 59S/PH1-IPB
10	2	1 59S/PH2
3	2	1 59S/PH2-3P
30	2	1 59S/PH2-30P
100	*2	100 59S/PH2-IP
500	*2	500 59S/PH2-IPB
3	3	1 59S/PH3-3P
30	3	1 59S/PH3-30P
500	3	500 59S/PH3-IPB
10	4	1 59S/PH4
3	4	1 59S/PH4-3P

1/4" Standard Screwdriver Bits for Phillips Dry Wall Head Screws 25 mm



59S/PH2G

3	PH 2G	1 59S/PH2G-3P
30	PH2G	1 59S/PH2G-30P

1/4" Standard Screwdriver Bits for Pozidriv Head Screws 25 mm



59S/PZ

X	Icon	Icon	Icon	Icon
10	0	1	59S/PZ0	
3	0	1	59S/PZ0-3P	
10	1	1	59S/PZ1	
3	1	1	59S/PZ1-3P	
30	1	1	59S/PZ1-30P	
100	*1	100	59S/PZ1-IP	
500	*1	500	59S/PZ1-IPB	
3	2	1	59S/PZ2-3P	
30	2	1	59S/PZ2-30P	
100	*2	100	59S/PZ2-IP	
500	*2	500	59S/PZ2-IPB	
10	3	1	59S/PZ3	
3	3	1	59S/PZ3-3P	
30	3	1	59S/PZ3-30P	
500	3	500	59S/PZ3-IPB	
10	4	1	59S/PZ4	

X	Icon	Icon	Icon	Icon
30	T10	1	59S/T10-30P	
10	T15	1	59S/T15-10P	
3	T15	1	59S/T15-3P	
30	T15	1	59S/T15-30P	
3	T20	1	59S/T20-3P	
30	T20	1	59S/T20-30P	
10	T25	1	59S/T25	
3	T25	1	59S/T25-3P	
30	T25	1	59S/T25-30P	
10	T27	1	59S/T27	
3	T27	1	59S/T27-3P	
5	T30	1	59S/T30-10P	
3	T30	1	59S/T30-3P	
30	T30	1	59S/T30-30P	
5	T40	1	59S/T40	
3	T40	1	59S/T40-3P	
30	T40	1	59S/T40-30P	
3	T45	1	59S/T45-3P	
5	T45	1	59S/T45-5P	
5	T50	1	59S/T50	
3	T50	1	59S/T50-3P	

X	Icon	Icon	Icon	Icon
5	TR 8	1	59S/TR8	
3	TR8	1	59S/TR8-3P	
5	TR 9	1	59S/TR9	
3	TR9	1	59S/TR9-3P	
5	TR 10	1	59S/TR10	
3	TR 10	1	59S/TR10-3P	
5	TR 15	1	59S/TR15	
3	TR 15	1	59S/TR15-3P	
5	TR 20	1	59S/TR20	
3	TR 20	1	59S/TR20-3P	
5	TR 25	1	59S/TR25	
3	TR 25	1	59S/TR25-3P	
5	TR 27	1	59S/TR27	
3	TR 27	1	59S/TR27-3P	
5	TR 30	1	59S/TR30	
3	TR 30	1	59S/TR30-3P	
5	TR 40	1	59S/TR40	
3	TR 40	1	59S/TR40-3P	

1/4" Standard Screwdriver Bits for TORX® Head Screws 25 mm



59S/T

X	Icon	Icon	Icon	Icon
5	T3	1	59S/T3	
3	T3	1	59S/T3-3P	
5	T4	1	59S/T4	
3	T4	1	59S/T4-3P	
5	T5	1	59S/T5	
3	T5	1	59S/T5-3P	
10	T6	1	59S/T6	
3	T6	1	59S/T6-3P	
10	T7	1	59S/T7	
3	T7	1	59S/T7-3P	
10	T8	1	59S/T8	
3	T8	1	59S/T8-3P	
10	T9	1	59S/T9	
3	T9	1	59S/T9-3P	
10	T10	1	59S/T10	
3	T10	1	59S/T10-3P	

1/4" Standard Screwdriver Conical Bits for Torx® Head Screws 25 mm



59S/TCS

X	Icon	Icon	Icon	Icon
10	T10	1	59S/T10CS	
10	T15	1	59S/T15CS	
10	T20	1	59S/T20CS	
10	T25	1	59S/T25CS	
10	T27	1	59S/T27CS	
10	T30	1	59S/T30CS	
10	T40	1	59S/T40CS	

1/4" Standard Screwdriver Bits for Metric Hex Head Screws 25 mm



59S/H mm

X	Icon	Icon	Icon	Icon
5	1.5	1	59S/H1.5	
3	1.5	1	59S/H1.5-3P	
5	2	1	59S/H2	
3	2	1	59S/H2-3P	
5	2.5	1	59S/H2.5	
3	2.5	1	59S/H2.5-3P	
5	3	1	59S/H3	
3	3	1	59S/H3-3P	
5	4	1	59S/H4	
3	4	1	59S/H4-3P	
500	4	500	59S/H4-IPB	
5	5	1	59S/H5	
3	5	1	59S/H5-3P	
5	6	1	59S/H6	
3	6	1	59S/H6-3P	
3	8	1	59S/H8-3P	
5		1	59S/H8-5P	
5	10	1	59S/H10	
3	10	1	59S/H10-3P	

1/4" Standard Screwdriver Bits for TORX® Tamper-Resistant Screws 25 mm



59S/TR

X	Icon	Icon	Icon	Icon
5	TR 7	1	59S/TR7	
3	TR7	1	59S/TR7-3P	



1/4" Standard Screwdriver Bits for Imperial Hex Head Screws 25 mm



59S/H "

Quantity	Size	Part Number
3	1/16 in	1 59S/H1/16-3P
5	5/16 in	1 59S/H5/16-5P
3	5/64 in	1 59S/H5/64-3P
5	5/64 in	1 59S/H5/64-5P
3	3/32 in	1 59S/H3/32-3P
5	3/32 in	1 59S/H3/32-5P
3	7/64 in	1 59S/H7/64-3P
5		1 59S/H7/64-5P
3	1/8 in	1 59S/H1/8-3P
5	1/8 in	1 59S/H1/8-5P
3	9/64 in	1 59S/H9/64-3P
3	5/32 in	1 59S/H5/32-3P
5	5/32 in	1 59S/H5/32-5P
3	3/16 in	1 59S/H3/16-3P
5	3/16 in	1 59S/H3/16-5P
3	7/32 in	1 59S/H7/32-3P
5	7/32 in	1 59S/H7/32-5P
3	1/4 in	1 59S/H1/4-3P
5	1/4 in	1 59S/H1/4-5P
3	5/16 in	1 59S/H5/16-3P
3	3/8 in	1 59S/H3/8-3P
5	3/8 in	1 59S/H3/8-5P

1/4" Standard Screwdriver Bits for Robertson Head Screws 25 mm



59S/R

Quantity	Size	Part Number
10	# 1	1 59S/R1
3	# 1	1 59S/R1-3P
10	# 2	1 59S/R2
3	# 2	1 59S/R2-3P
10	# 3	1 59S/R3
3	# 3	1 59S/R3-3P
10	# 4	1 59S/R4

1/4" Standard Screwdriver Bits for TORQ-SET Security Head Screws 25 mm - 5 Pcs/ Plastic Box



59S/TS

Quantity	Size	Part Number
5	0	1 59S/TS-0
5	1	1 59S/TS-1
5	2	1 59S/TS-2
5	3	1 59S/TS-3
5	4	1 59S/TS-4-5P
5	5	1 59S/TS-5-5P
5	6	1 59S/TS-6-5P
5	8	1 59S/TS-8-5P
5	10	1 59S/TS-10-5P

1/4" Imperial Standard Screwdriver Bits for TORQ-SET® Head Screws 25 mm



59S/TS "

Quantity	Size	Part Number
5	1/4"	1 59S/TS-1/4

1/4" Standard Screwdriver Bits for Tri-Wing Head Screws 25 mm - 5 Pcs/Plastic Box



59S/TW

Quantity	Size	Part Number
5	TW 0	1 59S/TW0
5	TW 1	1 59S/TW1
5	TW 2	1 59S/TW2
5	TW 3	1 59S/TW3
5	TW 4	1 59S/TW4
5	TW 5	1 59S/TW5

1/4" Standard Screwdriver Bits for XZN Head Screws 25 mm



59S/M

Quantity	Size	Part Number
10	M3	1 59S/M3
3	M3	1 59S/M3-3P
10	M4	1 59S/M4
3	M4	1 59S/M4-3P
10	M5	1 59S/M5
3	M5	1 59S/M5-3P
10	M6	1 59S/M6
3	M6	1 59S/M6-3P
10	M8	1 59S/M8
3	M8	1 59S/M8-3P

1/4" Standard Screwdriver Bits for Slotted Head Screws 50 mm



59S/50

Quantity	Size	Part Number
5	3.5 mm	1 59S/50/0.6-3.5
5	4.0 mm	1 59S/50/0.8-4.0
5	5.5 mm	1 59S/50/0.8-5.5
5	6.0 mm	1 59S/50/1.0-6.0
5	6.5 mm	1 59S/50/1.2-6.5
2	3.5 mm	1 59S/50/3.5-2P
2	4.0 mm	1 59S/50/4.0-2P
2	5.5 mm	1 59S/50/5.5-2P
2	6.0 mm	1 59S/50/6.0-2P
2	6.5 mm	1 59S/50/6.5-2P

1/4" Standard Screwdriver Bits for Phillips Head Screws 50 mm



59S/50PH

Quantity	Size	Part Number
5	1	1 59S/50PH1
2	1	1 59S/50PH1-2P
5	2	1 59S/50PH2-5P
2	2	1 59S/50PH2-2P
2	3	1 59S/50PH3-2P
5	3	1 59S/50PH3-5P

1/4" Standard Screwdriver Bits for Pozidriv Head Screws 50 mm



59S/50PZ

X		+		P	
2	1	1	59S/50PZ1-2P		
2	2	1	59S/50PZ2-2P		
5	2	1	59S/50PZ2-5P		
2	3	1	59S/50PZ3-2P		
5	3	1	59S/50PZ3-5P		

1/4" Standard Screwdriver Bits for TORX® Head Screws 50 mm



59S/50T

X		T	
5	T 8	1	59S/50T8
2	T 8	1	59S/50T8-2P
5	T 10	1	59S/50T10
2	T10	1	59S/50T10-2P
5	T 15	1	59S/50T15
2	T15	1	59S/50T15-2P
5	T 20	1	59S/50T20-5P
2	T20	1	59S/50T20-2P
5	T 25	1	59S/50T25
2	T25	1	59S/50T25-2P
5	T 27	1	59S/50T27
5	T 30	1	59S/50T30
2	T30	1	59S/50T30-2P
5	T 40	1	59S/50T40
2	T40	1	59S/50T40-2P

1/4" Standard Screwdriver Bits for Metric Hex Head Screws 50 mm



59S/50H

X		H	
5	2	1	59S/50H2
2	2	1	59S/50H2-2P
5	2.5	1	59S/50H2.5-5P
2	2.5	1	59S/50H2.5-2P

X		H		P	
5	3	1	59S/50H3		
2	3	1	59S/50H3-2P		
5	4	1	59S/50H4-5P		
2	4	1	59S/50H4-2P		
5	5	1	59S/50H5-5P		
2	5	1	59S/50H5-2P		
5	6	1	59S/50H6		
2	6	1	59S/50H6-2P		
2	8	1	59S/50H8-2P		
5	8	1	59S/50H8-5P		

1/4" Standard Screwdriver Bits for Imperial Hex Head Screws 50 mm



59S/50H "

X		H		P	
5	1/1 in	1	59S/50H1/16		
5	5/64 in	1	59S/50H5/64		
5	3/32 in	1	59S/50H3/32		
5	7/64 in	1	59S/50H7/64		
5	1/8 in	1	59S/50H1/8		
5	9/64 in	1	59S/50H9/64		
5	5/32 in	1	59S/50H5/32		
5	3/16 in	1	59S/50H3/16		
5	7/32 in	1	59S/50H7/32		
5	1/4 in	1	59S/50H1/4		
5	5/16 in	1	59S/50H5/16		
5	3/8 in	1	59S/50H3/8		

1/4" Standard Screwdriver Bits for Robertson Head Screws 50 mm



59S/50R

X		R		P	
5	#1	1	59S/50R1		
2	#1	1	59S/50R1-2P		
5	#2	1	59S/50R2		
2	#2	1	59S/50R2-2P		
5	#3	1	59S/50R3		
2	#3	1	59S/50R3-2P		

1/4" Standard Screwdriver Bits for Phillips Head Screws 70 mm



59S/70PH

X		PH	
2	1	1	59S/70PH1-2P
2	2	1	59S/70PH2-2P
5	2	1	59S/70PH2-5P

1/4" Standard Screwdriver Bits for Pozidriv Head Screws 70 mm



59S/70PZ

X		PZ	
5	1	1	59S/70PZ1
2	1	1	59S/70PZ1-2P
5	2	1	59S/70PZ2
2	2	1	59S/70PZ2-2P
5	3	1	59S/70PZ3
2	3	1	59S/70PZ3-2P

1/4" Standard Screwdriver Bits for TORX® Head Screws 70 mm



59S/70T

X		T	
5	T10	1	59S/70T10
2	T10	1	59S/70T10-2P
5	T15	1	59S/70T15
2	T15	1	59S/70T15-2P
2	T20	1	59S/70T20-2P
5	T20	1	59S/70T20-5P
2	T25	1	59S/70T25-2P
5	T25	1	59S/70T25-5P
5	T27	1	59S/70T27
2	T27	1	59S/70T27-2P
2	T30	1	59S/70T30-2P
5	T30	1	59S/70T30-5P
5	T40	1	59S/70T40
2	T40	1	59S/70T40-2P



1/4" Standard Screwdriver Bits for TORX®
Tamper-Resistant Screws 70 mm



59S/70TR

Quantity	Bit Type	Quantity	Part Number
5	TR15	1	59S/70TR15
2	TR15	1	59S/70TR15-2P
5	TR20	1	59S/70TR20
2	TR20	1	59S/70TR20-2P
5	TR25	1	59S/70TR25
2	TR25	1	59S/70TR25-2P
5	TR27	1	59S/70TR27
2	TR27	1	59S/70TR27-2P
5	TR30	1	59S/70TR30
2	TR30	1	59S/70TR30-2P
5	TR40	1	59S/70TR40
2	TR40	1	59S/70TR40-2P

1/4" Standard Screwdriver Bits for Phillips
Head Screws 125 mm



59S/125PH

Quantity	Bit Type	Quantity	Part Number
5	PH1	1	59S/125PH1
2	PH1	1	59S/125PH1-2P
5	PH2	1	59S/125PH2
2	PH2	1	59S/125PH2-2P
100	PH2-IP	100	59S/125PH2-IP
2	PH3	1	59S/125PH3-2P
5	PH3	1	59S/125PH3

1/4" Standard Screwdriver Bits for Pozidriv
Head Screws 125 mm



59S/125PZ

Quantity	Bit Type	Quantity	Part Number
5	PZ1	1	59S/125PZ1
2	PZ1	1	59S/125PZ1-2P
5	PZ2	1	59S/125PZ2
2	PZ2	1	59S/125PZ2-2P
5	PZ3	1	59S/125PZ3
2	PZ3	1	59S/125PZ3-2P

1/4" Standard Screwdriver Bits for Hex
with Ball Point Screws 89 mm



59S/H BALL

Quantity	Bit Size	Quantity	Part Number
5	3	1	59S/H3BALL
2	3	1	59S/H3BALL-2P
5	4	1	59S/H4BALL
2	4	1	59S/H4BALL-2P
5	5	1	59S/H5BALL
2	5	1	59S/H5BALL-2P
5	6	1	59S/H6BALL
2	6	1	59S/H6BALL-2P
5	8	1	59S/H8BALL
2	8	1	59S/H8BALL-2P
3	5,6,8	1	59S/HBALL-3P

1/4" Standard Screwdriver Bits for Plus-
Minus/Phillips Head Screws 125 mm



59S/PH COMBI

Quantity	Bit Type	Quantity	Part Number
2	5.0/PH1	1	59S/PH1COMBI-2P
2	6.0/PH2	1	59S/PH2COMBI-2P
2	8.0/PH3	1	59S/PH3COMBI-2P

1/4" Standard Screwdriver Bits for TORX®
Head Screws 150 mm



59S/150T

Quantity	Bit Type	Quantity	Part Number
5	T15	1	59S/150T15
2	T15	1	59S/150T15-2P
5	T20	1	59S/150T20
2	T20	1	59S/150T20-2P
5	T25	1	59S/150T25
2	T25	1	59S/150T25-2P
5	T30	1	59S/150T30
2	T30	1	59S/150T30-2P

7/16" Screwdriver Bits for Hex Head
Screws 35 mm



74S/H

Quantity	Bit Size	Quantity	Part Number
5	4 mm	1	74S/H4
2	4 mm	1	74S/H4-2P
5	5 mm	1	74S/H5
2	5 mm	1	74S/H5-2P
5	6 mm	1	74S/H6
2	6 mm	1	74S/H6-2P
5	7 mm	1	74S/H7
2	7 mm	1	74S/H7-2P
5	8 mm	1	74S/H8
2	8 mm	1	74S/H8-2P
5	10 mm	1	74S/H10
2	10 mm	1	74S/H10-2P
5	12 mm	1	74S/H12
2	12 mm	1	74S/H12-2P
5	14 mm	1	74S/H14
2	14 mm	1	74S/H14-2P
5	17 mm	1	74S/H17
2	17 mm	1	74S/H17-2P

5/32" Standard Screwdriver Bits for Phillips Head Screws 25 mm



45S/PH

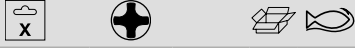

5	1	1	45S/PH1
2	1	1	45S/PH1-2P
5	2	1	45S/PH2
2	2	1	45S/PH2-2P

5/32" Standard Screwdriver Bits for Hex Head Screws 25 mm



45S/H

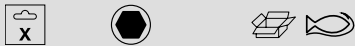

5	1.5 mm	1	45S/H1.5
2	1.5 mm	1	45S/H1.5-2P
5	2 mm	1	45S/H2
2	2 mm	1	45S/H2-2P
5	2.5 mm	1	45S/H2.5
2	2.5 mm	1	45S/H2.5-2P
5	3 mm	1	45S/H3
2	3 mm	1	45S/H3-2P

1/4" Bit Set for Phillips/Pozidriv/TORX® Head Screws - 7 Pcs



59S/7-1

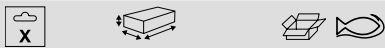

7	22 x 65 x 75 mm	1	59S/7-1
---	-----------------	---	---------

59S/PH1, 59S/PH2



59S/PZ1, 59S/PZ2



59S/T15, 59S/T20



1/4" Bit Set for Phillips/TORX® Head Screws - 7 Pcs



59S/7-2

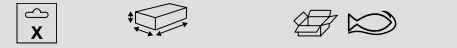

7	22 x 65 x 75 mm	1	59S/7-2
---	-----------------	---	---------

59S/PH2



59S/T15x 2, 59S/T20x 2, 59S/T25



1/4" Bit Set for TORX® Tamper Resistant Screws - 7 Pcs



59S/7-3

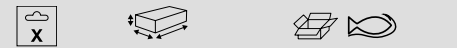

7	22 x 65 x 75 mm	1	59S/7-3
---	-----------------	---	---------

59S/TR10, 59S/TR15, 59S/TR20, 59S/TR25, 59S/TR30, 59S/TR40



1/4" Bit Set for TORX® Head Screws - 7 Pcs



59S/7-4



7	22 x 65 x 75 mm	1	59S/7-4
---	-----------------	---	---------

59S/T10, 59S/T15, 59S/T20, 59S/T25, 59S/T30, 59S/T40

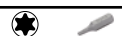

1/4" Bit Set for Phillips/Pozidriv/Torx® Head Screws in a Plastic Holder with Belt Clip - 10 pcs



59S/10BC



10	23 x 68 x 168 mm	1	59S/10BC
----	------------------	---	----------

1/4" Conical Bit Set for Torx® Head Screws - 11 pcs



59S/TCS11-1

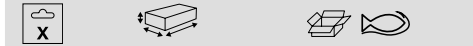

11	108 x 68 x 31 mm	1	59S/TCS11-1
----	------------------	---	-------------

59S/T10CS, 59S/T15CS, 59S/T20CSx 3, 59S/T25CSx 2, 59S/T30CSx 2, 59S/T40CS



KM653-QR-1P



1/4" Bit Set for Slotted/Phillips/Pozidriv/Hex Head Screws - 17 Pcs



59S/17-1



17	27 x 73 x 82 mm	1	59S/17-1
----	-----------------	---	----------

59S/0.5-3.0, 59S/0.6-4.5, 59S/0.8-5.5



59S/PH1, 59S/PH2x 3



59S/PH2Gx 2



59S/PZ1, 59S/PZ2x 2

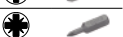

59S/H3, 59S/H4, 59S/H5, 59S/H6



1/4" Bit Set for TORX® Head Screws - 17 Pcs



59S/17-2

17	27 x 73 x 82 mm	1	59S/17-2

59S/T7, 59S/T8, 59S/T9, 59S/T10, 59S/T15x 2, 59S/T20x 3, 59S/T25x 3, 59S/T27, 59S/T30x 2, 59S/T40

1/4" Bit Set for Phillips/ Pozidriv/TORX®/ Hex Head Screws - 17 Pcs



59S/17-3

17	27 x 73 x 82 mm	1	59S/17-3

59S/PH1, 59S/PH2x 2
59S/PZ1, 59S/PZ2, 59S/PZ3
59S/T10, 59S/T15, 59S/T20, 59S/T25, 59S/T27, 59S/T30, 59S/T40
59S/H3, 59S/H4, 59S/H5

1/4" bit set for Slotted/Phillips/Pozidriv/TORX® Head Screw - 22 Pcs



59S/22-1

22	20 x 50 x 80 mm	1	59S/22-1

59S/0.5-3.0, 59S/0.6-4.5, 59S/0.8-5.5		
59S/PH1, 59S/PH2, 59S/PH3		
59S/PH2G		
59S/PZ1, 59S/PZ2, 59S/PZ3		
59S/T6, 59S/T8, 59S/T9, 59S/T10, 59S/T15, 59S/T20, 59S/T25, 59S/T27, 59S/T30, 59S/T40		
K6650-1/4		

1/4" bit set for Phillips/ Hex/ TORX® Head Screw - 22 Pcs



59S/22-2

22	20 x 50 x 80 mm	1	59S/22-2

59S/PH2x 3		
59S/PH2Gx 3		
59S/PZ2x 2		
59S/T10, 59S/T15x 4, 59S/T20x 3, 59S/T25x 2		
59S/H2.5, 59S/H3		
K6650-1/4		

1/4" Bit set for Slotted/ Phillips/ TORX®/ Hex/ TORQ-SET head screw - 28 Pcs



59S/28

28	30 x 58 x 110 mm	1	59S/28-4

59S/0.6-4.5, 59S/1.2-6.5, 59S/1.2-8.0		
59S/PH1x 2, 59S/PH2x 2, 59S/PH3		
59S/T6, 59S/T15		
59S/H5/64, 59S/H3/32, 59S/H7/64, 59S/H1/8, 59S/H5/32, 59S/H3/16, 59S/H7/32, 59S/TS-4x 2, 59S/TS-6x 2, 59S/TS-8x 2, 59S/TS-10x 2, K6625-1/4, KM653		
59S/H9/64		

1/4" Bit Set for Slotted/Phillips/Pozidriv/TORX®/Hex Head Screw - 31 Pcs



59S/31B

31	40.25 x 104.90 x 65.35 mm	1	59S/31B

59S/0.6-4.5, 59S/1.0-5.5		
59S/PH1, 59S/PH2x 3, 59S/PH3		
59S/PH2Gx 2		
59S/PZ1, 59S/PZ2x 3, 59S/PZ3		
59S/T10, 59S/T15x 3, 59S/T20x 3, 59S/T25x 2, 59S/T27, 59S/T30		
59S/H3, 59S/H4, 59S/H5, 59S/H6		
K6625-1/4-1P		
KM653-QR-1P		

1/4" Bit Set for Slotted/Phillips/Pozidriv/TORX®/Hex Head Screw - 31 Pcs/12 Pcs Carton Display



59S/31B-IP

12	280 x 375 x 210 mm	12	59S/31B-IP

Order 12 pieces of the ref. 59S/31B-IP to receive 1 display

1/4" bit set for Slotted/ Phillips/ Pozidriv/ Hex/ TORX® screw - 31 Pcs



59S/31-1

31	42 x 65 x 110 mm	1	59S/31-1

59S/0.5-3.0, 59S/0.6-4.5, 59S/0.8-5.5		
59S/PH1, 59S/PH2x 3, 59S/PH3		
59S/PH2Gx 2		
59S/PZ1, 59S/PZ2x 3, 59S/PZ3		
59S/T10, 59S/T15x 3, 59S/T20x 3, 59S/T25x 2, 59S/T27, 59S/T30		
59S/H3, 59S/H4, 59S/H5, 59S/H6		
66IM/KM75QR-1P		

1/4" Bit Set for Phillips/Pozidriv/TORX® Screws - 31 Pcs



59S/31-2

31	42 x 65 x 110 mm	1	59S/31-2

59S/PH2x 4		
59S/PH2Gx 4		
59S/PZ2x 4		
59S/T10x 2, 59S/T15x 4, 59S/T20x 5, 59S/T25x 5, 59S/T30x 2		
KM653-QR-1P		

1/4" Bit Set for Phillips/Pozidriv/TORX® Tamper Resistant Screws - 31 Pcs



59S/31-3

31	42 x 65 x 110 mm	1	59S/31-3

59S/PH1x 2, 59S/PH2x 2, 59S/PH3		
59S/PZ1x 2, 59S/PZ2x 2, 59S/PZ3		
59S/TR10x 2, 59S/TR15x 3, 59S/TR20x 5, 59S/TR25x 4, 59S/TR27, 59S/TR30x 4, 59S/TR40		
KM653-QR-1P		

1/4" bit set for Phillips/ Pozidriv/ Hex/ TORX® head screw - 35 Pcs



59/S35BC

35	50 x 110 x 180 mm	1	59/S35BC

1/4" Bit Set for Slotted/Phillips/Pozidriv/ Hex/TORX®/TORX® Tamper/Robertson Screw - 54 Pcs



59/S54BC

54	50 x 110 x 184 mm	1	59/S54BC

TORX bits are colored to easy identify the size of the tip

1/4" Bit Set for Slotted/Phillips/Pozidriv/ Hex/TORX®/TORX® Tamper/Robertson Screw - 54 Pcs/8 Pcs Carton Display



59/S54BC-IP

54	300 x 190 x 280 mm	8	59/S54BC-IP

Order 8 pieces of the re. 59/S54BC-IP to receive 1 display TORX bits are colored to easy identify the size of the tip

1/4" Bit Set for Slotted/Phillips/Pozidriv/ Hex/ TORX®/TORX® Tamper/Robertson Screw - 100 Pcs



59/S100BC

100	50 x 110 x 184 mm	1	59/S100BC

TORX bits are colored

1/4" Bit Set for Slotted/Phillips/Pozidriv/ Hex/ TORX®/TORX® Tamper/Robertson Screw - 100 Pcs/8 Pcs Carton Display



59/S100BC-IP

100	300 x 190 x 280 mm	8	59/S100BC-IP

Order 8 pieces of the re. 59/S100BC-IP to receive 1 display TORX bits are colored to easy identify the size of the tip



1/4" Standard Bit and Socket Set for Slotted/Phillips/Pozidriv/TORX®/Hex Head Screw - 26 Pcs



2058/S26

26	80 x 100 x 35 mm	1 2058/S26
26	35 x 85 x 105 mm	1 SB-2058/S26

SB: Retail pack on a plastic info card

2058-BR	
K6625-1/4-1P	
59S/H6, 59S/H5, 59S/H4, 59S/H3	
59S/T15, 59S/T10, 59S/T30, 59S/T25, 59S/T20	
59S/PZ3, 59S/PZ1, 59S/PZ2	
59S/PH1, 59S/PH2, 59S/PH3	
59S/0.8-5.5, 59S/0.5-4.0	
6700SM-8, 6700SM-7, 6700SM-6, 6700SM-13, 6700SM-10	
59S/1.0-6.0-1P	
KM753-QR-1P	

1/4" Standard Bit and Socket Set for Slotted/Phillips/Pozidriv/TORX®/Hex Head Screw - 26 Pcs



2058/S26AF

26	80 x 100 x 35 mm	1 2058/S26AF

1/4" Small Bit and Socket Set for Slotted/Phillips/Pozidriv/TORX®/Hex Head Screw - 26 Pcs



2058/S26-2

80 x 100 x 35 mm	1 2058/S26-2

2058-BR	
6700SM-8, 6700SM-7, 6700SM-6, 6700SM-5, 6700SM-4	
K6625-1/4B-1P, KM653-QR-1P	
59S/0.5-3.0, 59S/0.8-5.5, 59S/0.5-4.0	
59S/T8, 59S/T7, 59S/T6, 59S/T5, 59S/T4	
59S/PZ1, 59S/PZ0, 59S/PZ2	
59S/H2, 59S/H2.5, 59S/H1.5, 59S/H3	
59S/PH1, 59S/PH0, 59S/PH2	

1/4" Standard Screwdriver Bit Set for PH2 Head Screws 25 mm - 5 Pcs



5	13 x 17 x 132 mm	1 59S/PH2PEN

1/4" Standard Screwdriver Bit Set for PZ2 Head Screws 25 mm - 5 Pcs



5	13 x 17 x 132 mm	1 59S/PZ2PEN

1/4" Standard Screwdriver Bit Set for Torx® Screws 25 mm - 5 Pcs



5	13 x 17 x 132 mm	1	59S/T15PEN
5	13 x 17 x 132 mm	1	59S/T20PEN
5	13 x 17 x 132 mm	1	59S/T25PEN

1/4" Bit Pocket Set for Phillips/Pozidriv/Torx® Head Screws - 60 Pcs/Counter Display



60	140 x 125 x 215 mm	1	59S/60PEN/DISP	

59S/T15PENx 5, 59S/T20PENx 30, 59S/T25PENx 5		
59S/PH2PENx 10		
59S/PZ2PENx 10		

5/16" Screwdriver Bits for Slotted Head Screws 41 mm



2	8.0 mm	1	70S/1.2-8.0-2P
5	9.0 mm	1	70S/1.6-9.0
2	9.0 mm	1	70S/1.6-9.0-2P
5	10.0 mm	1	70S/1.6-10.0
2	10.0 mm	1	70S/1.6-10.0-2P

5	12.0 mm	1	70S/2.0-12.0
2	12.0 mm	1	70S/2.0-12.0-2P
5	14.0 mm	1	70S/2.5-14.0
2	14.0 mm	1	70S/2.5-14.0-2P

5/16" Screwdriver Bits for Phillips Head Screws 32 mm-38 mm



70S/PH



5	1	1	70S/PH1
2	1	1	70S/PH1-2P
5	2	1	70S/PH2
2	2	1	70S/PH2-2P
5	3	1	70S/PH3
2	3	1	70S/PH3-2P
5	4	1	70S/PH4
2	4	1	70S/PH4-2P

5/16" Screwdriver Bits for Pozidriv Head Screws 32 mm-38 mm



70S/PZ



5	1	1	70S/PZ1
2	1	1	70S/PZ1-2P
5	2	1	70S/PZ2
2	2	1	70S/PZ2-2P
5	3	1	70S/PZ3
2	3	1	70S/PZ3-2P
5	4	1	70S/PZ4
2	4	1	70S/PZ4-2P

5/16" Screwdriver Bits for TORX® Head Screws 35 mm



70S/T



5	T25	1	70S/T25-5P
5	T20	1	70S/T20
2	T20	1	70S/T20-2P

2	T25	1	70S/T25-2P
5	T27	1	70S/T27-5P
2	T27	1	70S/T27-2P
5	T30	1	70S/T30
2	T30	1	70S/T30-2P
2	T40	1	70S/T40-2P
5	T45	1	70S/T45
2	T45	1	70S/T45-2P
5	T50	1	70S/T50
2	T50	1	70S/T50-2P
5	T55	1	70S/T55
2	T55	1	70S/T55-2P

5/16" Screwdriver Bits for TORQ-SET® Head Screws 32 mm



70S/TS



5	8 mm	1	70S/TS8
2	8 mm	1	70S/TS8-2P
5	10 mm	1	70S/TS10
2	10 mm	1	70S/TS10-2P

5/16" Imperial Screwdriver Bits for TORQ-SET® Head Screws 32 mm



70S/TS"



5	1/4"	1	70S/TS1/4
2	1/4"	1	70S/TS1/4-2P
5	5/16"	1	70S/TS5/16
2	5/16"	1	70S/TS5/16-2P

5/16" Screwdriver Bits for Hex Socket Head Screws 30 mm



70S/H



5	4 mm	1	70S/H4
2	4 mm	1	70S/H4-2P
5	5 mm	1	70S/H5
2	5 mm	1	70S/H5-2P
5	6 mm	1	70S/H6
2	6 mm	1	70S/H6-2P
5	7 mm	1	70S/H7
2	7 mm	1	70S/H7-2P
5	8 mm	1	70S/H8-5P
2	8 mm	1	70S/H8-2P
5	10 mm	1	70S/H10
2	10 mm	1	70S/H10-2P
5	12 mm	1	70S/H12
2	12 mm	1	70S/H12-2P
5	14 mm	1	70S/H14
2	14 mm	1	70S/H14-2P

5/16" Hand Operated Impact Driver with 1/2" Square Drive 125 mm



5521

125 mm	1	5521

1/2" Square screwdriver adaptor for bits 5/16"



54640

40 mm	1	54640



5/16" Bit Set for Slotted/ Phillips/Hex/ TORX® Head Screws - 23 Pcs



7823

23	45 x 70 x 197 mm	1 7823

5521

54640

70S/1.2-8.0, 70S/1.6-10.0, 70S/2.0-12.0

70S/PH2, 70S/PH3, 70S/PH4

70S/T20, 70S/T25, 70S/T27, 70S/T30, 70S/T40, 70S/T45, 70S/T50, 70S/T55

70S/H4, 70S/H5, 70S/H6, 70S/H7, 70S/H8, 70S/H10, 70S/H12, 70S/H14

5/16" Bit Set for Slotted/Phillips/Hex Head Screws - 14 Pcs



7865

15	55 x 90 x 220 mm	1 7865

Including 1 adapter, hexagon 5/16" to 3/8" square drive

5521

54640

70S/1.2-8.0, 70S/1.6-10.0

70S/PH1, 70S/PH2, 70S/PH3, 70S/PH4

70S/H4, 70S/H5, 70S/H6, 70S/H8

Threaded Screwdriver Bits for Phillips Head Screws



K18

1	2	1 K18NF-2
1	2	1 K18PH-2M5
1	2	1 K18PH-2M6

Threaded Screwdriver Bits for Pozidriv Head Screws



K19PZD-2NF

1	2	1 K19PZD-2NF
1	2	1 K19PZD-2M5

Threaded Screwdriver Bits for TORX® Head Screws 44.5 mm



K20TORX

1	T25	1 K20TORX-T25

1/4" Hex Head Non-Magnetic Power Nut Drivers



K6750

1	1/4 in	1 K6750-6
1	1/4 in	1 K6750-7
1	1/4 in	1 K6750-10-1P
1	1/4 in	1 K6750-13
1	1/4 in	1 K6750-1/4
1	1/4 in	1 K6750-3/8

1/4" Hex Head Magnetic Power Nut Drivers



KM6750

1		1 KM6750-6
1		1 KM6750-7
1		1 KM6750-10-1P
1		1 KM6750-11
1		1 KM6750-13-1P
1		1 KM6750-1/4
1		1 KM6750-3/8

1/4" Hex Universal Magnetic Bit Holders with Quick Release 60 mm



KM653-QR

1	1/4"	1 KM653-QR-1P
5	1/4"	1 KM653-QR-5P

1/4" Hex Universal Magnetic Bit Holders with Quick Release 75 mm



KM753-QR



1 1/4 in 1 KM753-QR-1P

1/4" Heavy-Duty Torsion Screwdriver Bit Holders



KMT753-QR-1P



1/4 in 1/4 in 1 KMT753-QR-1P

1/4" Hex Universal Magnetic Bit Holders with Retaining Ring 75 mm



KMR753



1 1/4 in 1 KMR753-1P
5 1/4 in 1 KMR753

1/4" Hex Universal Bit Holders with Retaining Ring 60 mm



KR653



1 1/4 in 1 KR653-1P
5 1/4 in 1 KR653

1/4" Hex Universal magnetic bit holder with Swivel Function 65 mm



KM653-SF

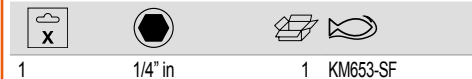

1 1/4" in 1 KM653-SF

1/4" Hex Copper-Beryllium Universal bit holder with Retaining Ring 75 mm



KCB753

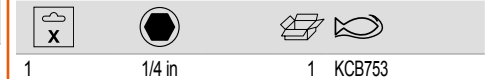

1 1/4 in 1 KCB753

1/4" Hex Universal Magnetic Bit Holders 60 mm



KM653



1 1/4" 1 KM653-1P
5 1/4" 1 KM653-5P

1/4" Hex Universal Magnetic Bit Holders with Retaining Ring 60 mm



KMR653



1 1/4 in 1 KMR653-1P
5 1/4 in 1 KMR653-5P

1/4" Hex Universal Magnetic Bit Holders with Retaining Ring 150 mm



KMR150



1 1/4 in 1 KMR150-1P
5 1/4 in 1 KMR150



1/4" Hex drive Universal Magnetic Bit Holder for 5/16" bits 70 mm



KM1/4-5/16-1P

1	1/4 in	1	KM1/4-5/16-1P

1/4" Hex Drive to 1/4" Socket adaptors 25 mm



K6625

1	1/4 in	1	K6625-1/4-1P
5		1	K6625-1/4B-5P

1/4" Hex Drive to 3/8" Socket Adaptors 38 mm



K6638

1	1/4 in	1	K6638-3/8-1P
5	1/4 in	1	K6638-3/8

1/4" Hex Drive to 1/4", 3/8", 1/2" Socket Adaptors 50 mm



K6650

1		1	K6650-1/4B-1P
5		1	K6650-1/4P-5P
1	1/4 in	1	K6650-3/8-1P
5		1	K6650-3/8P-5P
1	1/4 in	1	K6650-1/2-1P
5		1	K6650-1/2P-5P

1/4" Hex Drive to 1/4", 3/8" Socket Adaptors 100 mm



K66100

1	1/4 in	1	K66100-1/4-1P
5	1/4 in	1	K66100-1/4
1	1/4 in	1	K66100-3/8-1P
5	1/4 in	1	K66100-3/8

1/4" Hex Drive to 1/4" Socket Adaptor with Quick Release 60 mm



K6660-QR

1	1/4 in	1	K6660-QR-1P

IMPACT TOOLS

1/4" Square Drive Impact Sockets with Metric Hex Profile and Phosphate Finish



K6701M

6 mm	1	K6701M-6
7 mm	1	K6701M-7
8 mm	1	K6701M-8
9 mm	1	K6701M-9
10 mm	1	K6701M-10
11 mm	1	K6701M-11
12 mm	1	K6701M-12
13 mm	1	K6701M-13
14 mm	1	K6701M-14

1/4" Square Drive Impact Sockets with Metric Hex Profile and Phosphate Finish - Retail Pack



SBK6701M

6 mm	1	SBK6701M-6
7 mm	1	SBK6701M-7
8 mm	1	SBK6701M-8
9 mm	1	SBK6701M-9
10 mm	1	SBK6701M-10
11 mm	1	SBK6701M-11
12 mm	1	SBK6701M-12
13 mm	1	SBK6701M-13
14 mm	1	SBK6701M-14

1/4" Square Drive Magnetic Impact Sockets with Metric Hex Profile and Phosphate Finish



KM6701M

Hex Size	Quantity	Part Number
7 mm	1	KM6701M-7
8 mm	1	KM6701M-8
10 mm	1	KM6701M-10

Safety Clamping Springs for 1/4" Impact Socket



K560F-1

Hex Size	Quantity	Part Number
1/4 in	5	K560F-1

3/8" Square Drive Impact Sockets with Metric Hex Profile and Phosphate Finish



K7401M

Hex Size	Quantity	Part Number
7 mm	1	K7401M-7
8 mm	1	K7401M-8
9 mm	1	K7401M-9
10 mm	1	K7401M-10
11 mm	1	K7401M-11
12 mm	1	K7401M-12
13 mm	1	K7401M-13
14 mm	1	K7401M-14
15 mm	1	K7401M-15
16 mm	1	K7401M-16
17 mm	1	K7401M-17
18 mm	1	K7401M-18

Hex Size	Quantity	Part Number
19 mm	1	K7401M-19
20 mm	1	K7401M-20
21 mm	1	K7401M-21
22 mm	1	K7401M-22
24 mm	1	K7401M-24

3/8" Square Drive Impact Sockets with Metric Hex Profile and Phosphate Finish - Retail Pack



SBK7401M

Hex Size	Quantity	Part Number
7 mm	1	SBK7401M-7
8 mm	1	SBK7401M-8
9 mm	1	SBK7401M-9
10 mm	1	SBK7401M-10
11 mm	1	SBK7401M-11
12 mm	1	SBK7401M-12
13 mm	1	SBK7401M-13
14 mm	1	SBK7401M-14
15 mm	1	SBK7401M-15
16 mm	1	SBK7401M-16
17 mm	1	SBK7401M-17
18 mm	1	SBK7401M-18
19 mm	1	SBK7401M-19
20 mm	1	SBK7401M-20
21 mm	1	SBK7401M-21
22 mm	1	SBK7401M-22
24 mm	1	SBK7401M-24

3/8" Square Drive Deep Impact Sockets with Metric Hex Profile and Phosphate Finish



K7406M

Hex Size	Quantity	Part Number
10 mm	1	K7406M-10
13 mm	1	K7406M-13
17 mm	1	K7406M-17

3/8" Square Drive Impact Sockets with Imperial Hex Profile



K7401Z

Hex Size	Quantity	Part Number
3/8 in	1	K7401Z-3/8
7/16 in	1	K7401Z-7/16
1/2 in	1	K7401Z-1/2
9/16 in	1	K7401Z-9/16
5/8 in	1	K7401Z-5/8
11/16 in	1	K7401Z-11/16
3/4 in	1	K7401Z-3/4
13/16 in	1	K7401Z-13/16
7/8 in	1	K7401Z-7/8

3/8" Square Drive to 1/4" Bit Holder Power Adaptors



K172

Hex Size	Quantity	Part Number
1/4"	1	K172

3/8" Square Drive Bit Holder Adaptors with Phosphate Finish



7407H-7409H

Hex Size	Quantity	Part Number
1/4"	1	7407H
5/16"	1	7408H
11	1	7409H



3/8" Square Drive Impact Sockets with TORX® Head Profile and Phosphate Finish



K7401TORX-E



Socket Size	Hex Size	Quantity	Part Number
E5	M4	1	K7401TORX-E5
E6	M5	1	K7401TORX-E6
E7	M6	1	K7401TORX-E7
E8	M6, M7	1	K7401TORX-E8
E10	M6, M8	1	K7401TORX-E10
E12	M8, M10	1	K7401TORX-E12
E14	M10, M12	1	K7401TORX-E14

3/8" Square Drive Impact Power Swivel Sockets with Metric Hex Profile



KS7401M



Socket Size	Quantity	Part Number
3/8 in	1	KS7401M-9
3/8 in	1	KS7401M-10
3/8 in	1	KS7401M-11
3/8 in	1	KS7401M-12
3/8 in	1	KS7401M-13
3/8 in	1	KS7401M-14
3/8 in	1	KS7401M-15
3/8 in	1	KS7401M-16
3/8 in	1	KS7401M-17
3/8 in	1	KS7401M-18
3/8 in	1	KS7401M-19
3/8 in	1	KS7401M-22

3/8" Square Drive Ball Joint Sockets with Phosphate Finish



K7767S

Socket Size	Ball Joint Size	Quantity	Part Number
3/8"	3/8"	1	K7767S

3/8" Square Drive Adaptors with Phosphate Finish



K6964C

Adaptor Size	Socket Size	Quantity	Part Number
1/4"	3/8"	1	K6964C

3/8" Square Drive Adaptors with Phosphate Finish



K8164C

Adaptor Size	Socket Size	Quantity	Part Number
1/2"	3/8"	1	K8164C

3/8" Square Drive Extensions with Phosphate Finish



K7760C

Extension Length	Quantity	Part Number
75 mm	1	K7760C-1
150 mm	1	K7760C-2

Safety Clamping Springs for 3/8" Impact Socket



K560F-2/3

Socket Size	Hex Size	Quantity	Part Number
3/8"	7-12	5	K560F-2
3/8"	13-24	5	K560F-3

Impact Hexagon Sockets Set with Metric Hex Profile -10 Pcs



K7401M/10

Quantity	Part Number
10	K7401M/10

K7401M-10, K7401M-11, K7401M-12, K7401M-13, K7401M-14, K7401M-15, K7401M-16, K7401M-17, K7401M-18, K7401M-19

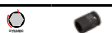

3/8" Square Drive Impact Socket Set with TORX® Head Profile and Phosphate Finish - 7 Pcs



K7401TORX-E-S7



7 1 K7401TORX-E-S7

K7401TORX-E5, K7401TORX-E6, K7401TORX-E7, K7401TORX-E8, K7401TORX-E10, K7401TORX-E12, K7401TORX-E14



1/2" Square Drive Ultrashort Impact Sockets with Metric Hex Profile and Phosphate Finish



K7800M



10 mm	1	K7800M-10
11 mm	1	K7800M-11
12 mm	1	K7800M-12
13 mm	1	K7800M-13
14 mm	1	K7800M-14
15 mm	1	K7800M-15
16 mm	1	K7800M-16
17 mm	1	K7800M-17
18 mm	1	K7800M-18
19 mm	1	K7800M-19
21 mm	1	K7800M-21
22 mm	1	K7800M-22
24 mm	1	K7800M-24

1/2" Square Drive Impact Sockets with Metric Hex Profile and Phosphate Finish



K7801M



8 mm	1	K7801M-8
9 mm	1	K7801M-9
10 mm	1	K7801M-10
11 mm	1	K7801M-11
12 mm	1	K7801M-12
13 mm	1	K7801M-13
14 mm	1	K7801M-14
15 mm	1	K7801M-15
16 mm	1	K7801M-16
17 mm	1	K7801M-17
18 mm	1	K7801M-18
19 mm	1	K7801M-19
20 mm	1	K7801M-20
21 mm	1	K7801M-21
22 mm	1	K7801M-22
23 mm	1	K7801M-23
24 mm	1	K7801M-24
25 mm	1	K7801M-25
26 mm	1	K7801M-26
27 mm	1	K7801M-27
28 mm	1	K7801M-28
29 mm	1	K7801M-29
30 mm	1	K7801M-30
32 mm	15	K7801M-32
34 mm	1	K7801M-34
36 mm	1	K7801M-36

1/2" Square Drive Impact Sockets with Metric Hex Profile and Phosphate Finish - Retail Pack



SBK7801M



8 mm	1	SBK7801M-8
9 mm	1	SBK7801M-9
10 mm	1	SBK7801M-10
11 mm	1	SBK7801M-11



12 mm	1	SBK7801M-12
13 mm	1	SBK7801M-13
14 mm	1	SBK7801M-14
15 mm	1	SBK7801M-15
16 mm	1	SBK7801M-16
17 mm	1	SBK7801M-17
18 mm	1	SBK7801M-18
19 mm	1	SBK7801M-19
20 mm	1	SBK7801M-20
21 mm	1	SBK7801M-21
22 mm	1	SBK7801M-22
23 mm	1	SBK7801M-23
24 mm	1	SBK7801M-24
25 mm	1	SBK7801M-25
26 mm	1	SBK7801M-26
27 mm	1	SBK7801M-27
28 mm	1	SBK7801M-28
29 mm	1	SBK7801M-29
30 mm	1	SBK7801M-30
32 mm	1	SBK7801M-32
34 mm	1	SBK7801M-34
36 mm	1	SBK7801M-36

1/2" Square Drive Deep Impact Sockets with Metric Hex Profile and Phosphate Finish



K7806M



10 mm	1	K7806M-10
11 mm	1	K7806M-11
12 mm	1	K7806M-12
13 mm	1	K7806M-13
14 mm	1	K7806M-14
15 mm	1	K7806M-15
16 mm	1	K7806M-16
17 mm	1	K7806M-17
18 mm	1	K7806M-18
19 mm	1	K7806M-19
21 mm	1	K7806M-21
22 mm	1	K7806M-22
23 mm	1	K7806M-23
24 mm	1	K7806M-24
27 mm	1	K7806M-27
30 mm	1	K7806M-30
32 mm	1	K7806M-32
36 mm	1	K7806M-36

SB: Retail pack on a plastic info card



1/2" Square Drive Deep Impact Sockets with Metric Hex Profile and Phosphate Finish - Retail Pack



SBK7806M

Hex Size	Quantity	Part Number
10 mm	1	SBK7806M-10
11 mm	1	SBK7806M-11
12 mm	1	SBK7806M-12
13 mm	1	SBK7806M-13
14 mm	1	SBK7806M-14
15 mm	1	SBK7806M-15
16 mm	1	SBK7806M-16
17 mm	1	SBK7806M-17
18 mm	1	SBK7806M-18
19 mm	1	SBK7806M-19
21 mm	1	SBK7806M-21
22 mm	1	SBK7806M-22
23 mm	1	SBK7806M-23
24 mm	1	SBK7806M-24
27 mm	1	SBK7806M-27
30 mm	1	SBK7806M-30
32 mm	1	SBK7806M-32
36 mm	1	SBK7806M-36

SB: Retail pack on a plastic info card

1/2" Square Drive Reinforced Impact Sockets with Metric Hex Profile and Phosphate Finish



K7801VM

Hex Size	Quantity	Part Number
17 mm	1	K7801VM-17
19 mm	1	K7801VM-19
22 mm	1	K7801VM-22
24 mm	1	K7801VM-24

1/2" Square Drive Impact Sockets with Imperial Hex Profile and Phosphate Finish



K7801Z

Hex Size	Quantity	Part Number
3/8 in	1	K7801Z-3/8
7/16 in	1	K7801Z-7/16
1/2 in	1	K7801Z-1/2
9/16 in	1	K7801Z-9/16
5/8 in	1	K7801Z-5/8
11/16 in	1	K7801Z-11/16
3/4 in	1	K7801Z-3/4
13/16 in	1	K7801Z-13/16
7/8 in	1	K7801Z-7/8
15/16 in	1	K7801Z-15/16
1 in	1	K7801Z-1
1 1/16 in	1	K7801Z-1.1/16
1 1/8 in	1	K7801Z-1.1/8
1 1/4 in	1	K7801Z-1.1/4
1 5/16 in	5	K7801Z-1.5/16
1 3/8 in	5	K7801Z-1.3/8
1 7/16 in	5	K7801Z-1.7/16
1 1/2 in	5	K7801Z-1.1/2

1/2" Square Drive Impact Sockets with Imperial Hex Profile and Phosphate Finish - Retail Pack



SBK7801Z

Hex Size	Quantity	Part Number
3/8 in	1	SBK7801Z-3/8
7/16 in	1	SBK7801Z-7/16
1/2 in	1	SBK7801Z-1/2
9/16 in	1	SBK7801Z-9/16
5/8 in	1	SBK7801Z-5/8
11/16 in	1	SBK7801Z-11/16
3/4 in	1	SBK7801Z-3/4
13/16 in	1	SBK7801Z-13/16
7/8 in	1	SBK7801Z-7/8
15/16 in	1	SBK7801Z-15/16
1 in	1	SBK7801Z-1
1 1/16 in	1	SBK7801Z-1.1/16
1 1/8 in	1	SBK7801Z-1.1/8
1 1/4 in	1	SBK7801Z-1.1/4
1 5/16 in	1	SBK7801Z-1.5/16
1 3/8 in	1	SBK7801Z-1.3/8

Hex Size	Quantity	Part Number
1 7/16 in	1	SBK7801Z-1.7/16
1 1/2 in	1	SBK7801Z-1.1/2

SB: Retail pack on a plastic info card

1/2" Square Drive Deep Impact Sockets with Imperial Hex Profile and Phosphate Finish



K7806Z

Hex Size	Quantity	Part Number
3/8 in	10	K7806Z-3/8
7/16 in	5	K7806Z-7/16
1/2 in	10	K7806Z-1/2
9/16 in	10	K7806Z-9/16
5/8 in	5	K7806Z-5/8
11/16 in	5	K7806Z-11/16
3/4 in	5	K7806Z-3/4
13/16 in	5	K7806Z-13/16
7/8 in	5	K7806Z-7/8
15/16 in	5	K7806Z-15/16
1 in	5	K7806Z-1
1 1/16 in	5	K7806Z-1.1/16
1 1/8 in	5	K7806Z-1.1/8
1 1/4 in	5	K7806Z-1.1/4
1 5/16 in	5	K7806Z-1.5/16
1 3/8 in	5	K7806Z-1.3/8
1 7/16 in	5	K7806Z-1.7/16
1 1/2 in	5	K7806Z-1.1/2

SB: Retail pack on a plastic info card

1/2" Square Drive Deep Impact Sockets with Imperial Hex Profile and Phosphate Finish - Retail pack



SBK7806Z

Hex Size	Quantity	Part Number
3/8 in	10	SBK7806Z-3/8
7/16 in	10	SBK7806Z-7/16
1/2 in	10	SBK7806Z-1/2
9/16 in	10	SBK7806Z-9/16
5/8 in	5	SBK7806Z-5/8
11/16 in	1	SBK7806Z-11/16
3/4 in	1	SBK7806Z-3/4
13/16 in	1	SBK7806Z-13/16
7/8 in	1	SBK7806Z-7/8



15/16 in	1	SBK7806Z-15/16
1 in	1	SBK7806Z-1
1 1/16 in	1	SBK7806Z-1.1/16
1 1/8 in	5	SBK7806Z-1.1/8
1 1/4 in	1	SBK7806Z-1.1/4
1 5/16 in	1	SBK7806Z-1.5/16
1 3/8 in	5	SBK7806Z-1.3/8
1 7/16 in	5	SBK7806Z-1.7/16
1 1/2 in	1	SBK7806Z-1.1/2

SB: Retail pack on a plastic info card

1/2" Square Drive Impact Socket Drivers for Hex Head Screws Phosphate Finish



7993S



5 mm	1	7993S0050
6 mm	1	7993S0060
8 mm	1	7993S0080
10 mm	1	7993S0100
12 mm	1	7993S0120
14 mm	1	7993S0140
17 mm	1	7993S0170
18 mm	1	7993S0180
19 mm	1	7993S0190

1/2" Square Drive Impact Socket Drivers for TORX® Head Screws Phosphate Finish



7994S



T20	1	7994S0200
T25	1	7994S0250
T27	1	7994S0270
T-30	1	7994S0300
T-40	1	7994S0400
T-45	1	7994S0450
T-50	1	7994S0500
T-55	1	7994S0550
T-60	1	7994S0600
T-70	1	7994S0700

1/2" Square Drive Impact Sockets with TORX® Head Profile and Phosphate Finish



K7801TORX-E



E10	1	K7801TORX-E10
E12	1	K7801TORX-E12
E14	1	K7801TORX-E14
E16	1	K7801TORX-E16
E18	1	K7801TORX-E18
E20	1	K7801TORX-E20
E24	1	K7801TORX-E24

1/2" Square Drive Bit Holders with Phosphate Finish



7807H-7809H

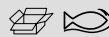

1/2"	1/4 in	1	7807H
1/2"	5/16 in	1	7808H
1/2"	11.2 mm	1	7809H
1/2"	1/4 in	1	SB7807H
1/2"	5/16 in	1	SB7808H
1/2"	7/16 in	1	SB7809H

1/2" Square Drive Extensions with Phosphate Finish



K8160D



75 mm	1	K8160D-1
125 mm	1	K8160D-2
250 mm	1	K8160D-3
75 mm	1	SBK8160D-1
125 mm	1	SBK8160D-2
250 mm	1	SBK8160D-3

1/2" Square Drive Ball Joint Sockets with Phosphate Finish



K8167S



1/2"	1/2"	1	K8167S
------	------	---	--------

1/2" Square Drive Adaptors with Phosphate Finish



K7764D/SBK7764D



M 3/8"	F 1/2"	1	K7764D
M 3/8"	F 1/2"	1	SBK7764D

SB: Retail pack

1/2" Square Drive to 3/4" Increasing Adaptor with Phosphate Finish



K8964D/SBK8964D



3/4"	1/2"	1	K8964D
M 3/4"	F 1/2"	1	SBK8964D

SB: Retail pack on a plastic info card



Safety Clamping Springs for 1/2" Impact Socket



K560F-4/5

1/2"	10-14 mm	5	K560F-4
1/2"	15-32 mm	5	K560F-5

1/2" Square Drive Ultrashort impact socket set, 1/2" - 13 Pcs



K7800M/13

43 x 128 x 195 mm	1	K7800M/13

K7800M-10, K7800M-11, K7800M-12, K7800M-13, K7800M-14, K7800M-15, K7800M-16, K7800M-17, K7800M-18, K7800M-19, K7800M-21, K7800M-22, K7800M-24

4750IB-A5

1/2" Square Drive Deep Impact Socket Set in Case with Metric Hex Profile and Phosphate Finish - 4 Pcs



K7806M/S4

4	1	K7806M/S4

K7806M-19, K7806M-22, K7806M-17, K7806M-24

4750IB-A5

1/2" Square Drive Reinforced Impact Socket Set with Metric Hex Profile and Phosphate Finish - 4 Pcs



K7801VM/S4

4	1	K7801VM/S4

K7801VM-22, K7801VM-19, K7801VM-17, K7801VM-24

1/2" Square Drive Impact Socket Set with Imperial Hex Profile and Phosphate Finish - 10 Pcs



K7801Z/10

10	60 x 220 x 280 mm	1	K7801Z/10

K7801Z-7/16, K7801Z-1/2, K7801Z-11/16, K7801Z-5/8, K7801Z-13/16, K7801Z-3/4, K7801Z-15/16, K7801Z-7/8, K7801Z-1, K7801Z-9/16

1/2" Square Drive Deep Impact Socket Set with Imperial Hex Profile and Phosphate Finish - 10 Pcs



K7806Z/10

10	60 x 220 x 280 mm	1	K7806Z/10

K7806Z-7/16, K7806Z-1/2, K7806Z-9/16, K7806Z-3/4, K7806Z-13/16, K7806Z-11/16, K7806Z-1, K7806Z-7/8, K7806Z-15/16, K7806Z-5/8

1/2" Square Drive Deep Impact Socket Set with Metric Hex Profile and Phosphate Finish - 14 Pcs



DD/S14

14	4	DD/S14

K7806M-10, K7806M-11, K7806M-12, K7806M-13, K7806M-14, K7806M-15, K7806M-16, K7806M-17, K7806M-18, K7806M-19, K7806M-21, K7806M-22, K7806M-24, K7806M-27

1/2" Square Drive Mixed Impact Socket Set with Metric Hex Profile and Phosphate Finish - 20 Pcs



D-DD/

20	4	D-DD/S20

K7801M-10, K7801M-11, K7801M-12, K7801M-13, K7801M-14, K7801M-15, K7801M-16, K7801M-17, K7801M-18, K7801M-19

K7806M-10, K7806M-11, K7806M-12, K7806M-13, K7806M-14, K7806M-16, K7806M-17, K7806M-18, K7806M-19

1/2" Square Drive Impact Socket Set with Metric Hex Profile and Phosphate Finish - 10 Pcs



D/

10	6	D/S10

K7801M-10, K7801M-11, K7801M-12, K7801M-13, K7801M-14, K7801M-15, K7801M-16, K7801M-17, K7801M-18, K7801M-19

1/2" Square Drive Impact Socket Set with Metric Hex Profile and Phosphate Finish - 14 Pcs



D/S14

14	6	D/S14

K7801M-10, K7801M-11, K7801M-12, K7801M-13, K7801M-14, K7801M-15, K7801M-16, K7801M-17, K7801M-18, K7801M-19, K7801M-21, K7801M-22, K7801M-24, K7801M-27

1/2" Square Drive Deep Impact Socket Set with Metric Hex Profile and Phosphate Finish - 10 Pcs



DD/

10	6	DD/S10

K7806M-10, K7806M-11, K7806M-12, K7806M-13, K7806M-14, K7806M-15, K7806M-16, K7806M-17, K7806M-18, K7806M-19

3/4" Square Drive Impact Sockets with Metric Hex Profile and Phosphate Finish



K8901M

17 mm	1	K8901M-17
18 mm	1	K8901M-18
19 mm	1	K8901M-19
21 mm	1	K8901M-21
22 mm	1	K8901M-22
23 mm	1	K8901M-23
24 mm	1	K8901M-24
27 mm	1	K8901M-27
28 mm	1	K8901M-28
29 mm	1	K8901M-29
30 mm	1	K8901M-30
32 mm	1	K8901M-32
33 mm	1	K8901M-33
34 mm	1	K8901M-34
36 mm	1	K8901M-36
38 mm	1	K8901M-38
41 mm	1	K8901M-41
46 mm	1	K8901M-46
50 mm	1	K8901M-50
55 mm	1	K8901M-55
60 mm	1	K8901M-60

SB: Retail pack on a plastic info card

3/4" Square Drive Impact Sockets with Metric Hex Profile Hang sell



SBK8901M

17 mm	1	SBK8901M-17
18 mm	1	SBK8901M-18
19 mm	1	SBK8901M-19
21 mm	1	SBK8901M-21
22 mm	1	SBK8901M-22
23 mm	1	SBK8901M-23
24 mm	1	SBK8901M-24
27 mm	1	SBK8901M-27
28 mm	1	SBK8901M-28
29 mm	1	SBK8901M-29
30 mm	1	SBK8901M-30
32 mm	1	SBK8901M-32
33 mm	1	SBK8901M-33
34 mm	1	SBK8901M-34
36 mm	1	SBK8901M-36
38 mm	1	SBK8901M-38
41 mm	1	SBK8901M-41
46 mm	1	SBK8901M-46
55 mm	1	SBK8901M-55
60 mm	1	SBK8901M-60
50 mm	1	SBK8901M-50

SB: Retail pack on a plastic info card

3/4" Square Drive Deep Impact Sockets with Metric Hex Profile and Phosphate Finish



K8906M

17 mm	1	K8906M-17
19 mm	1	K8906M-19
21 mm	1	K8906M-21
22 mm	1	K8906M-22
24 mm	1	K8906M-24
27 mm	1	K8906M-27
30 mm	1	K8906M-30
32 mm	1	K8906M-32
33 mm	1	K8906M-33
34 mm	1	K8906M-34
36 mm	1	K8906M-36
41 mm	1	K8906M-41
42 mm	1	K8906M-42
46 mm	1	K8906M-46

SB: Retail pack on a plastic info card



3/4" Square Drive Impact Sockets with Imperial Hex Profile and Phosphate Finish



Hex Profile	Part Number
1.1/4 in	1 K8906Z-1.1/4
1.5/16 in	1 K8906Z-1.5/16
1.3/8 in	1 K8906Z-1.3/8
1.7/16 in	1 K8906Z-1.7/16
1.1/2 in	1 K8906Z-1.1/2
1.5/8 in	1 K8906Z-1.5/8
1.3/4 in	1 K8906Z-1.3/4
2 mm	1 K8906Z-2

SB: Retail pack on a plastic info card

K8901Z



11/16 in	1 K8901Z-11/16
3/4 in	1 K8901Z-3/4
13/16 in	1 K8901Z-13/16
7/8 in	1 K8901Z-7/8
15/16 in	1 K8901Z-15/16
1 in	1 K8901Z-1
1 1/16 in	1 K8901Z-1.1/16
1 1/8 in	1 K8901Z-1.1/8
1 3/16 in	1 K8901Z-1.3/16
1 1/4 in	1 K8901Z-1.1/4
1 5/16 in	1 K8901Z-1.5/16
1 3/8 in	1 K8901Z-1.3/8
1 7/16 in	1 K8901Z-1.7/16
1 1/2 in	1 K8901Z-1.1/2
1 9/16 in	1 K8901Z-1.9/16
1 5/8 in	1 K8901Z-1.5/8
1 11/16 in	1 K8901Z-1.11/16
1 3/4 in	1 K8901Z-1.3/4
1 13/16 in	1 K8901Z-1.13/16
1 7/8 in	1 K8901Z-1.7/8
1 15/16 in	1 K8901Z-1.15/16
2 in	1 K8901Z-2
2 1/16 in	1 K8901Z-2.1/16
2 3/16 in	1 K8901Z-2.3/16
2 1/4 in	1 K8901Z-2.1/4
2 3/8 in	1 K8901Z-2.3/8

SB: Retail pack on a plastic info card

3/4" Square Drive Deep Impact Sockets with Imperial Hex Profile and Phosphate Finish



K8906Z

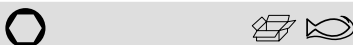

3/4 in	1 K8906Z-3/4
13/16 in	1 K8906Z-13/16
7/8 in	1 K8906Z-7/8
15/16 in	1 K8906Z-15/16
1 mm	1 K8906Z-1
1 1/16 in	1 K8906Z-1.1/16
1.1/8 in	1 K8906Z-1.1/8

3/4" Square Drive Impact Socket Drivers for Hex Head Screws Phosphate Finish



7993T

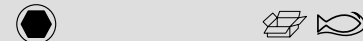

12 mm	1 7993T0120
14 mm	1 7993T0140
17 mm	1 7993T0170
19 mm	1 7993T0190
22 mm	1 7993T0220
24 mm	1 7993T0240

3/4" Square Drive Bit Holders with Phosphate Finish



K8909H



22 mm	3/4"	1 K8909H-5
-------	------	------------

3/4" Square Drive Ball Joint Sockets with Phosphate Finish



K8967S



3/4"	3/4"	1 K8967S
------	------	----------

3/4" Square Drive Adaptors with Phosphate Finish



K8164F



1/2"	3/4"	1 K8164F
------	------	----------

3/4" Square Drive to 1" Socket Increasing Adaptors with Phosphate Finish



K9564F



1"	3/4"	1 K9564F
----	------	----------

3/4" Square Drive Extensions with Phosphate Finish



K8960F



175 mm	1	K8960F-2
250 mm	1	K8960F-3
325 mm	1	K8960F-4

Safety Clamping Springs for 3/4" Impact Socket



K560F-6



3/4"	17-46 mm	5	K560F-6
------	----------	---	---------

3/4" Square Drive Impact Socket Set with Metric Hex Profile and Phosphate Finish - 8 Pcs



K8901M/8



8	65 x 240 x 350 mm	1	K8901M/8
---	-------------------	---	----------

K8901M-27, K8901M-24, K8901M-21, K8901M-22, K8901M-30, K8901M-32, K8901M-36, K8901M-41

3/4" Square Drive Deep Impact Socket Set with Metric Hex Profile and Phosphate Finish - 8 Pcs



K8906M/8



8	80 x 250 x 315 mm	1	K8906M/8
---	-------------------	---	----------

K8906M-24, K8906M-27, K8906M-30, K8906M-41, K8906M-36, K8906M-21, K8906M-22, K8906M-32

3/4" Square Drive Impact Socket Set with Imperial Hex Profile and Phosphate Finish - 8 Pcs



K8901Z/8



8	80 x 250 x 310 mm	1	K8901Z/8
---	-------------------	---	----------

K8901Z-1.1/16, K8901Z-1, K8901Z-1.3/8, K8901Z-1.5/16, K8901Z-1.1/4, K8901Z-1.1/2, K8901Z-1.7/16, K8901Z-1.1/8

3/4" Square Drive Impact Socket Set with Imperial Hex Profile and Phosphate Finish - 18 Pcs



K8901Z/18



18	100 x 210 x 595 mm	1	K8901Z/18
----	--------------------	---	-----------

K8901Z-11/16, K8901Z-3/4, K8901Z-13/16, K8901Z-7/8, K8901Z-15/16, K8901Z-1, K8901Z-1.1/16, K8901Z-1.1/8, K8901Z-1.3/16, K8901Z-1.1/4, K8901Z-1.5/16, K8901Z-1.3/8, K8901Z-1.7/16, K8901Z-1.1/2, K8901Z-1.9/16, K8901Z-1.5/8, K8901Z-1.11/16, K8901Z-1.3/4

3/4" Square Drive Deep Impact Socket Set with Imperial Hex Profile and Phosphate Finish - 8 Pcs



K8906Z/8



8	125 x 250 x 110 mm	1	K8906Z/8
---	--------------------	---	----------

K8906Z-1, K8906Z-1.1/16, K8906Z-1.1/8, K8906Z-1.1/4, K8906Z-1.5/16, K8906Z-1.3/8, K8906Z-1.7/16, K8906Z-1.1/2



1" Square Drive Impact Sockets with Metric Hex Profile and Phosphate Finish



K9501M



22 mm	1	K9501M-22
24 mm	1	K9501M-24
27 mm	1	K9501M-27
30 mm	1	K9501M-30
32 mm	1	K9501M-32
33 mm	1	K9501M-33
34 mm	1	K9501M-34
36 mm	1	K9501M-36
38 mm	1	K9501M-38
41 mm	1	K9501M-41
42 mm	1	K9501M-42
46 mm	1	K9501M-46
50 mm	1	K9501M-50
55 mm	1	K9501M-55
60 mm	1	K9501M-60
65 mm	1	K9501M-65
70 mm	1	K9501M-70
75 mm	1	K9501M-75
80 mm	1	K9501M-80
85 mm	1	K9501M-85

1" Square Drive Impact Sockets with Imperial Hex Profile and Phosphate Finish



K9501Z



1 in	1	K9501Z-1
1 1/16 in	1	K9501Z-1.1/16
1 1/8 in	1	K9501Z-1.1/8
1 3/16 in	1	K9501Z-1.3/16
1 1/4 in	1	K9501Z-1.1/4
1 5/16 in	1	K9501Z-1.5/16
1 3/8 in	1	K9501Z-1.3/8
1 7/16 in	1	K9501Z-1.7/16
1 1/2 in	1	K9501Z-1.1/2
1 9/16 in	1	K9501Z-1.9/16
1 5/8 in	1	K9501Z-1.5/8
1 11/16 in	1	K9501Z-1.11/16
1 3/4 in	1	K9501Z-1.3/4
1 13/16 in	1	K9501Z-1.13/16
1 7/8 in	1	K9501Z-1.7/8
15/16 in	1	K9501Z-1.15/16
2 in	1	K9501Z-2
2 1/8 in	1	K9501Z-2.1/8
2 3/16 in	1	K9501Z-2.3/16
2 1/4 in	1	K9501Z-2.1/4
2 5/16 in	1	K9501Z-2.5/16
2 9/16 in	1	K9501Z-2.9/16
2 3/4 in	1	K9501Z-2.3/4

1" Square Drive Bit Holders with 22 mm Male Hex Drive with Phosphate Finish



K9509H5



22 mm	1"	1	K9509H5
-------	----	---	---------

1" Square Drive Deep Impact Sockets with Metric Hex Profile and Phosphate Finish



K9506M



22 mm	1	K9506M-22
24 mm	1	K9506M-24
27 mm	1	K9506M-27
30 mm	1	K9506M-30
32 mm	1	K9506M-32
33 mm	1	K9506M-33
34 mm	1	K9506M-34
36 mm	1	K9506M-36
38 mm	1	K9506M-38
41 mm	1	K9506M-41
46 mm	1	K9506M-46
50 mm	1	K9506M-50
55 mm	1	K9506M-55
60 mm	1	K9506M-60

1" Square Drive Deep Impact Sockets with Imperial Hex Profile and Phosphate Finish



K9506Z



1 in	1	K9506Z-1
1 1/16 in	1	K9506Z-1.1/16
1 3/16 in	1	K9506Z-1.3/16
1 1/4 in	1	K9506Z-1.1/4
1 7/16 in	1	K9506Z-1.7/16
1 1/2 in	1	K9506Z-1.1/2
1 5/8 in	1	K9506Z-1.5/8
1 13/16 in	1	K9506Z-1.13/16
1 7/8 in	1	K9506Z-1.7/8

1" Square Drive Socket Drivers for Hex Head Screws Phosphate Finish



7993M



17 mm	1	7993M0170
19 mm	1	7993M0190
22 mm	1	7993M0220
27 mm	1	7993M0270

1" Square Drive Adaptors with Phosphate Finish



K8964G



3/4"	1"	1	K8964G
------	----	---	--------

1" to 1-1/2" Square Drive Adaptor with Phosphate Finish



K9895G

1 1/2"	1"	1	K9895G

1" Square Drive Extensions with Phosphate Finish



K9560G

100 mm	1	K9560G-0
125 mm	1	K9560G-1
175 mm	1	K9560G-2
325 mm	1	K9560G-3
300 mm	1	K9560G-4
400 mm	1	K9560G-5

1" Square Drive Ball Joint Sockets with Phosphate Finish



K9567S

1"	1"	1	K9567S

Bits with 22 mm Male Hex Drive



K8909ML/K9509ML

12 mm	1	K8909ML-12
14 mm	1	K8909ML-14
17 mm	1	K8909ML-17
19 mm	1	K9509ML-19
22 mm	1	K9509ML-22
24 mm	1	K9509ML-24

Safety Clamping Springs for 1" and 1-1/2" Impact Socket



K560F-7/8

1"	19-70 mm	5	K560F-7
1 & 1 1/2"	75-80 & 46-90 mm	5	K560F-8

1-1/2" Square Drive Impact Sockets with Metric Hex Profile and Phosphate Finish



K9801M

46 mm	1	K9801M-46
50 mm	1	K9801M-50
55 mm	1	K9801M-55
60 mm	1	K9801M-60

65 mm	1	K9801M-65
70 mm	1	K9801M-70
75 mm	1	K9801M-75
80 mm	1	K9801M-80
85 mm	1	K9801M-85
90 mm	1	K9801M-90
95 mm	1	K9801M-95
100 mm	1	K9801M-100
105 mm	1	K9801M-105
110 mm	1	K9801M-110
115 mm	1	K9801M-115
120 mm	1	K9801M-120
125 mm	1	K9801M-125
130 mm	1	K9801M-130
135 mm	1	K9801M-135
140 mm	1	K9801M-140
145 mm	1	K9801M-145
150 mm	1	K9801M-150
155 mm	1	K9801M-155

1-1/2" Square Drive Deep Impact Sockets with Metric Hex Profile and Phosphate Finish



K9806M

41 mm	1	K9806M-41
46 mm	1	K9806M-46
50 mm	1	K9806M-50
55 mm	1	K9806M-55
60 mm	1	K9806M-60
65 mm	1	K9806M-65
70 mm	1	K9806M-70
75 mm	1	K9806M-75
80 mm	1	K9806M-80
85 mm	1	K9806M-85
90 mm	1	K9806M-90
95 mm	1	K9806M-95
100 mm	1	K9806M-100
105 mm	1	K9806M-105
110 mm	1	K9806M-110
115 mm	1	K9806M-115
120 mm	1	K9806M-120



1-1/2" Square Drive Impact Sockets with Imperial Hex Profile and Phosphate Finish



K9801Z



1 3/8 in	1	K9801Z-1.3/8
1 7/16 in	1	K9801Z-1.7/16
1 1/2 in	1	K9801Z-1.1/2
1 9/16 in	1	K9801Z-1.9/16
1 5/8 in	1	K9801Z-1.5/8
1 11/16 in	1	K9801Z-1.11/16
1 3/4 in	1	K9801Z-1.3/4
1 13/16 in	1	K9801Z-1.13/16
1 7/8 in	1	K9801Z-1.7/8
1 15/16 in	1	K9801Z-1.15/16
2 in	1	K9801Z-2
2 1/16 in	1	K9801Z-2.1/16
2 1/8 in	1	K9801Z-2.1/8
2 3/16 in	1	K9801Z-2.3/16
2 1/4 in	1	K9801Z-2.1/4
2 5/16 in	1	K9801Z-2.5/16
2 3/8 in	1	K9801Z-2.3/8
2 7/16 in	1	K9801Z-2.7/16
2 1/2 in	1	K9801Z-2.1/2
2 9/16 in	1	K9801Z-2.9/16
2 5/8 in	1	K9801Z-2.5/8
2 11/16 in	1	K9801Z-2.11/16
2 3/4 in	1	K9801Z-2.3/4
2 13/16 in	1	K9801Z-2.13/16
2 7/8 in	1	K9801Z-2.7/8
2 15/16 in	1	K9801Z-2.15/16
3 in	1	K9801Z-3
3 1/16 in	1	K9801Z-3.1/16
3 1/8 in	1	K9801Z-3.1/8
3 1/4 in	1	K9801Z-3.1/4
3 5/16 in	1	K9801Z-3.5/16
3 3/8 in	1	K9801Z-3.3/8
3 7/16 in	1	K9801Z-3.7/16
3 1/2 in	1	K9801Z-3.1/2
3 9/16 in	1	K9801Z-3.9/16
3 5/8 in	1	K9801Z-3.5/8
3 11/16 in	1	K9801Z-3.11/16
3 3/4 in	1	K9801Z-3.3/4
3 13/16 in	1	K9801Z-3.13/16
3 7/8 in	1	K9801Z-3.7/8
3 15/16 in	1	K9801Z-3.15/16
4 in	1	K9801Z-4
4 1/16 in	1	K9801Z-4.1/16
4 1/8 in	1	K9801Z-4.1/8
4 1/4 in	1	K9801Z-4.1/4
4 5/16 in	1	K9801Z-4.5/16
4 3/8 in	1	K9801Z-4.3/8
4 7/16 in	1	K9801Z-4.7/16
4 1/2 in	1	K9801Z-4.1/2
4 5/8 in	1	K9801Z-4.5/8
4 3/4 in	1	K9801Z-4.3/4

1-1/2" Square Drive Deep Impact Sockets with Imperial Hex Profile and Phosphate Finish



K9806Z



1 3/8 in	1	K9806Z-1.3/8
1 7/16 in	1	K9806Z-1.7/16
1 1/2 in	1	K9806Z-1.1/2
1 5/8 in	1	K9806Z-1.5/8
1 11/16 in	1	K9806Z-1.11/16
2 in	1	K9806Z-2
2 1/16 in	1	K9806Z-2.1/16
2 3/16 in	1	K9806Z-2.3/16
2 1/4 in	1	K9806Z-2.1/4
2 5/16 in	1	K9806Z-2.5/16
2 3/8 in	1	K9806Z-2.3/8
2 7/16 in	1	K9806Z-2.7/16
2 1/2 in	1	K9806Z-2.1/2
2 9/16 in	1	K9806Z-2.9/16
2 5/8 in	1	K9806Z-2.5/8
2 11/16 in	1	K9806Z-2.11/16
2 3/4 in	1	K9806Z-2.3/4
2 13/16 in	1	K9806Z-2.13/16
2 7/8 in	1	K9806Z-2.7/8
2 15/16 in	1	K9806Z-2.15/16
3 in	1	K9806Z-3
3 1/16 in	1	K9806Z-3.1/16
3 1/8 in	1	K9806Z-3.1/8
3 3/16 in	1	K9806Z-3.3/16
3 1/4 in	1	K9806Z-3.1/4
3 5/16 in	1	K9806Z-3.5/16
3 3/8 in	1	K9806Z-3.3/8
3 7/16 in	1	K9806Z-3.7/16
3 1/2 in	1	K9806Z-3.1/2
3 9/16 in	1	K9806Z-3.9/16
3 5/8 in	1	K9806Z-3.5/8
3 11/16 in	1	K9806Z-3.11/16
3 3/4 in	1	K9806Z-3.3/4
3 13/16 in	1	K9806Z-3.13/16
3 7/8 in	1	K9806Z-3.7/8
3 15/16 in	1	K9806Z-3.15/16
4 in	1	K9806Z-4
4 1/16 in	1	K9806Z-4.1/16
4 1/8 in	1	K9806Z-4.1/8
4 1/4 in	1	K9806Z-4.1/4
4 5/16 in	1	K9806Z-4.5/16
4 3/8 in	1	K9806Z-4.3/8
4 7/16 in	1	K9806Z-4.7/16
4 1/2 in	1	K9806Z-4.1/2
4 5/8 in	1	K9806Z-4.5/8
4 3/4 in	1	K9806Z-4.3/4

1-1/2" Square Drive Ball Joints with Phosphate Finish



K9867S



1 1/2	1 1/2	1 K9867S
-------	-------	----------

1-1/2" Square Drive Extensions with Phosphate Finish



K9860H



255 mm	1	K9860H-1
380 mm	1	K9860H-2
510 mm	1	K9860H-3

1-1/2" Square Drive Adaptors with Phosphate Finish



K9598H



1	1 1/2	1 K9598H
---	-------	----------

1.1/2" Square Drive to 2.1/2" Socket
Increasing Adaptors with Phosphate Finish



K9998H



2 1/2

1 1/2

1 K9998H

2.1/2" Square Drive to 1.1/2" Socket
Reducing Adaptor with Phosphate Finish



K9899H



1 1/2

2 1/2

1 K9899H

Safety Clamping Springs for 1-1/2" Impact
Socket



K560F-9



1 1/2"

95-120 mm

5 K560F-9





BAHCO



Screwdrivers



ERGO™ SCREWDRIVERS WITH RIGGED RUBBER GRIP & COLOUR ID

ERGO™ TORX® Screwdriver Set with Rubber Grip - 5 Pcs



BE-9885

5 1 BE-9885

BE-8910, BE-8930, BE-8915, BE-8920, BE-8925

ERGO™ Slotted/Phillips Screwdriver Set with Rubber Grip - 6 Pcs



BE-9881

6 1 BE-9881

- BE-8020, BE-8040 ⊖
- BE-8150, BE-8155 ⊖
- BE-8620, BE-8610 ⊕

ERGO™ Slotted/Pozidriv Screwdriver Set with Rubber Grip - 6 Pcs



BE-9882

6 1 BE-9882

BAHCO

- BE-8020, BE-8040 ⊖
- BE-8155, BE-8150 ⊖
- BE-8810, BE-8820 ⊕

ERGO™ Slotted-Straight/Phillips/Pozidriv Screwdriver Set with Rubber Grip - 6 Pcs



BE-9884

6 1 BE-9884

- BE-8611, BE-8621 ⊕
- BE-8040, BE-8241 ⊖
- BE-8811, BE-8821 ⊕

ERGO™ Slotted/Phillips/Pozidriv Screwdriver Set with Rubber Grip - 6 Pcs



BE-9886

6 1 BE-9886

- BE-8030 ⊖
- BE-8150 ⊖
- BE-8621, BE-8611 ⊕
- BE-8821, BE-8811 ⊕

ERGO™ Slotted/Phillips/Pozidriv/TORX® Screwdriver Set with Rubber Grip - 6 Pcs



ergo®



BE-9871



6

1 BE-9871

BE-8220S		
BE-8920, BE-8925		
BE-8820		
BE-8611, BE-8620		

ERGO™ Slotted/Phillips/Pozidriv/Torx® Screwdriver Set with Rubber Grip - 8 pcs



ergo®



BE-9872



8

45 x 170 x 340 mm

595 g

1 BE-9872

BE-8925, BE-8920, BE-8915		
BE-8030		
BE-8821, BE-8811		
BE-8621, BE-8611		

ERGO™ Slotted/Phillips/Pozidriv/TORX® Screwdriver Set with Rubber Grip - 13 Pcs



ergo®



BE-9875



13

1 BE-9875

BE-8040		
BE-8150, BE-8155		
BE-8621		
BE-8811, BE-8821		
BE-8910, BE-8915, BE-8920, BE-8925		
BE-8010S, BE-8230S		
BE-8811S		

ERGO™ Slotted/Phillips/Pozidriv/TORX® Screwdriver Set with Rubber Grip - 13 Pcs



ergo®



BE-9879



13

1 BE-9879

BE-8010, BE-8040		
BE-8150		
BE-8611, BE-8621		
BE-8811, BE-8821		
BE-8910, BE-8915, BE-8920, BE-8925		
BE-8220SL		
BE-8620SL		



ERGO™ Slotted/Phillips/Pozidriv/TORX® Screwdriver Set with Rubber Grip - 15 Pcs



BE-9877



15

1 BE-9877

BE-8030		
BE-8150		
BE-8611, BE-8621		
BE-8811, BE-8821		
BE-8910, BE-8915, BE-8920, BE-8925		
BE-8220S, BE-8040S, BE-8050S		
BE-8611S, BE-8621S		

ERGO™ Slotted Straight Screwdrivers with Rubber Grip 2.0-6.5 mm



BE-8002 - BE-8252

Bit Size	Length	Tip Length	Quantity	Part No.
2.0 mm	60 mm	17 mm	5	BE-8002
2.5 mm	60 mm	17 mm	5	BE-8010
2.5 mm	75 mm	17 mm	5	BE-8210
3.0 mm	60 mm	17 mm	5	BE-8020
3.0 mm	75 mm	17 mm	5	BE-8020L
3.0 mm	100 mm	17 mm	5	BE-8022
3.0 mm	125 mm	17 mm	5	BE-8220
3.0 mm	200 mm	17 mm	5	BE-8225
3.5 mm	75 mm	17 mm	5	BE-8030
3.5 mm	125 mm	17 mm	5	BE-8230
3.5 mm	200 mm	17 mm	5	BE-8235
4.0 mm	100 mm	20 mm	5	BE-8040
4.0 mm	175 mm	20 mm	5	BE-8240
5.5 mm	125 mm	27 mm	5	BE-8241
5.5 mm	150 mm	27 mm	5	BE-8242
5.5 mm	200 mm	27 mm	5	BE-8250L
6.0 mm	150 mm	36 mm	5	BE-8251
6.5 mm	150 mm	36 mm	5	BE-8252

ERGO™ Slotted Flat Screwdrivers with Rubber Grip 5.5-10 mm



BE-8150 - BE-8258

Bit Size	Length	Tip Length	Quantity	Part No.
5.5 mm	100 mm	27 mm	5	BE-8150
5.5 mm	150 mm	27 mm	5	BE-8250
6.5 mm	125 mm	36 mm	5	BE-8155
6.5 mm	150 mm	36 mm	5	BE-8255
8 mm	150 mm	36 mm	5	BE-8256
8 mm	175 mm	36 mm	5	BE-8257
10 mm	200 mm	36 mm	5	BE-8258

ERGO™ Hex Bolster Slotted Flat Screwdrivers with Rubber Grip 5.5-8 mm



BE-8158 - BE-8890

Bit Size	Length	Tip Length	Quantity	Part No.
5.5 mm	125 mm	27 mm	5	BE-8158
6.5 mm	150 mm	36 mm	5	BE-8159
8 mm	125 mm	36 mm	5	BE-8160
8 mm	175 mm	36 mm	5	BE-8260
8 mm	175 mm	36 mm	5	BE-8865
10 mm	175 mm	36 mm	5	BE-8870
12 mm	200 mm	36 mm	5	BE-8880
14 mm	200 mm	36 mm	5	BE-8890

ERGO™ Stubby Slotted Straight Screwdrivers with Rubber Grip 3.5-8.0 mm



BE-8330 - BE-8360

Bit Size	Length	Tip Length	Quantity	Part No.
3.5 mm	25 mm	36 mm	5	BE-8330
4.0 mm	25 mm	36 mm	5	BE-8340
5.0 mm	25 mm	36 mm	5	BE-8350
5.0 mm	45 mm	36 mm	5	BE-8450

Tip Size	Length	Shaft Diameter	Weight	Part No.
6.5 mm	25 mm	36 mm	5	BE-8355
6.0 mm	45 mm	36 mm	5	BE-8455
8.0 mm	25 mm	36 mm	5	BE-8360

ERGO™ Phillips Screwdrivers with Rubber Grip PH0-PH4



BE-8600 - BE-8624



Tip	Length	Shaft Diameter	Weight	Part No.
PH 0	60 mm	17 mm	5	BE-8600
PH 0	100 mm	17 mm	5	BE-8605
PH 0	200 mm	17 mm	5	BE-8608
PH 1	75 mm	27 mm	5	BE-8610
PH 1	75 mm	20 mm	5	BE-8611
PH 1	* 200 mm	27 mm	5	BE-8610L
PH 2	100 mm	36 mm	5	BE-8620
PH 2	100 mm	27 mm	5	BE-8621
PH 2	150 mm	36 mm	5	BE-8622
PH 2	* 200 mm	36 mm	5	BE-8620L
PH 3	150 mm	36 mm	5	BE-8623
PH 4	200 mm	36 mm	5	BE-8624

ERGO™ Hex Bolster Phillips Screwdrivers with Rubber Grip PH1-PH4



BE-8628 - BE-8640



Tip	Length	Shaft Diameter	Weight	Part No.
PH 1	100 mm	27 mm	5	BE-8628
PH 2	125 mm	36 mm	5	BE-8629
PH 3	150 mm	36 mm	5	BE-8630
PH 4	200 mm	36 mm	5	BE-8640

ERGO™ Stubby Phillips Screwdrivers with Rubber Grip PH1-PH2



BE-8601/BE-8602



Tip	Length	Shaft Diameter	Weight	Part No.
PH 1	25 mm	36 mm	5	BE-8601
PH 2	25 mm	36 mm	5	BE-8602

ERGO™ Pozidriv Screwdrivers with Rubber Grip PZ0-PZ4



BE-8800 - BE-8824



Tip	Length	Shaft Diameter	Weight	Part No.
PZ 0	60 mm	17 mm	5	BE-8800
PZ 1	75 mm	27 mm	5	BE-8810
PZ 1	75 mm	20 mm	5	BE-8811
PZ 1	200 mm	27 mm	5	BE-8810L
PZ 2	100 mm	36 mm	5	BE-8820
PZ 2	100 mm	27 mm	5	BE-8821
PZ 2	200 mm	36 mm	5	BE-8820L
PZ 3	150 mm	36 mm	5	BE-8823
PZ 4	200 mm	36 mm	5	BE-8824

ERGO™ Hex Bolster Pozidriv Screwdrivers with Rubber Grip PZ1-PZ4



BE-8828 - BE-8840



Tip	Length	Shaft Diameter	Weight	Part No.
PZ 1	100 mm	27 mm	5	BE-8828
PZ 2	125 mm	36 mm	5	BE-8829
PZ 3	150 mm	36 mm	5	BE-8830
PZ 4	200 mm	36 mm	5	BE-8840



ERGO™ Stubby Pozidriv Screwdrivers with Rubber Grip PZ1-PZ2



BE-8801/BE-8802



PZ 1	25 mm	36 mm	5	BE-8801
PZ 2	25 mm	36 mm	5	BE-8802

ERGO™ TORX® Screwdrivers with Rubber Grip T4-T45



BE-8904 - BE-8945



T 4	75 mm	17 mm	5	BE-8904
T 5	75 mm	17 mm	5	BE-8905
T 6	75 mm	17 mm	5	BE-8906
T 7	75 mm	17 mm	5	BE-8907
T 8	75 mm	17 mm	5	BE-8908
T 9	75 mm	17 mm	5	BE-8909
T 10	75 mm	20 mm	5	BE-8910
T 15	100 mm	27 mm	5	BE-8915
T 20	100 mm	27 mm	5	BE-8920
T 25	125 mm	27 mm	5	BE-8925
T 27	125 mm	27 mm	5	BE-8927
T30	150 mm	36 mm	5	BE-8930
T40	150 mm	36 mm	5	BE-8940
T45	150 mm	36 mm	5	BE-8945

ERGO™ TORX® Tamper-Resistant Screwdrivers with Rubber Grip TR7-TR40



BE-7907 - BE-7940



TR 7	75 mm	17 mm	5	BE-7907
TR 8	75 mm	17 mm	5	BE-7908
TR 9	75 mm	17 mm	5	BE-7909

TR 10	75 mm	20 mm	5	BE-7910
TR 15	100 mm	27 mm	5	BE-7915
TR 20	100 mm	27 mm	5	BE-7920
TR 25	125 mm	27 mm	5	BE-7925
TR 27	125 mm	27 mm	5	BE-7927
TR 30	150 mm	36 mm	5	BE-7930
TR 40	150 mm	36 mm	5	BE-7940

ERGO™ TORX® Ball End Screwdrivers with Rubber Grip T15-T40



BE-7515 - BE-7540



T 15	100 mm	27 mm	5	BE-7515
T 20	100 mm	27 mm	5	BE-7520
T 25	125 mm	27 mm	5	BE-7525
T 27	125 mm	27 mm	5	BE-7527
T 30	150 mm	36 mm	5	BE-7530
T 40	150 mm	36 mm	5	BE-7540

ERGO™ TORX® Plus Screwdrivers with Rubber Grip T15-T40



BE-7715 - BE-7740



T 15	100 mm	27 mm	5	BE-7715
T 20	100 mm	27 mm	5	BE-7720
T 25	125 mm	27 mm	5	BE-7725
T 27	125 mm	27 mm	5	BE-7727
T 30	150 mm	36 mm	5	BE-7730
T 40	150 mm	36 mm	5	BE-7740

ERGO™ Hex Screwdrivers with Rubber Grip Hex2-3 mm



BE-6902 - BE-6903



Hex	Length	Tip	Icon	Part No.
2 mm	75 mm	17 mm		5 BE-6902
2.5 mm	75 mm	17 mm		5 BE-6925
3 mm	75 mm	20 mm		5 BE-6903

ERGO™ Hex Ball End Screwdrivers with Rubber Grip, metric 1.5-10 mm



BE-8715 - BE-8710



Hex	Length	Tip	Icon	Part No.
1.5 mm	60 mm	17 mm		5 BE-8715
2 mm	100 mm	17 mm		5 BE-8702
2.5 mm	100 mm	17 mm		5 BE-8725
3 mm	100 mm	20 mm		5 BE-8703
4 mm	100 mm	27 mm		5 BE-8704
5 mm	100 mm	36 mm		5 BE-8705
6 mm	125 mm	36 mm		5 BE-8706
8 mm	150 mm	36 mm		5 BE-8708
10 mm	150 mm	36 mm		5 BE-8710

ERGO™ Hex Ball End Screwdrivers with Rubber Grip, inches 7/64-3/8"



BE-8700-7/64 - BE-8700-5/16



Hex	Length	Tip	Icon	Part No.
7/64 in	100 mm	20 mm		5 BE-8700-7/64
5/32 in	100 mm	27 mm		5 BE-8700-5/32
3/16 in	100 mm	27 mm		5 BE-8700-3/16
7/32 in	100 mm	36 mm		5 BE-8700-7/32
1/4 in	125 mm	36 mm		5 BE-8700-1/4
5/16 in	150 mm	36 mm		5 BE-8700-5/16
3/8 in	150 mm	36 mm		5 BE-8700-3/8

ERGO™ Robertson - Square Screwdrivers with Rubber Grip #1-#3



BE-9001 - BE-9003



Size	Length	Tip	Icon	Part No.
# 1	80 mm	27 mm		5 BE-9001
# 2	80 mm	27 mm		5 BE-9002
# 3	100 mm	27 mm		5 BE-9003

ERGO™ TRI-WING® Security Screwdrivers with Rubber Grip #0-#5



BE-9100 - BE-9105



Size	Length	Tip	Icon	Part No.
0	80 mm	20 mm		5 BE-9100
1	80 mm	20 mm		5 BE-9101
2	80 mm	27 mm		5 BE-9102
3	80 mm	27 mm		5 BE-9103
4	100 mm	27 mm		5 BE-9104
5	100 mm	27 mm		5 BE-9105

ERGO™ TORQ-SET® Security Screwdrivers with Rubber Grip #1-#10



BE-8080



Size	Length	Tip	Icon	Part No.
1	75 mm	27 mm		5 BE-8080-1
2	75 mm	27 mm		5 BE-8080-2
3	75 mm	27 mm		5 BE-8080-3
4	75 mm	27 mm		5 BE-8080-4
5	75 mm	27 mm		5 BE-8080-5
6	75 mm	27 mm		5 BE-8080-6
8	100 mm	27 mm		5 BE-8080-8
10	100 mm	27 mm		5 BE-8080-10



ERGO™ Round Tip Awl Screwdriver with Rubber Grip



BE-8985

6 mm	100 mm	27 mm	5	BE-8985

ERGO™ Stubby Round Tip Awl Screwdriver with Rubber Grip 6 mm



BE-8986

4 mm	36 mm	50 mm	5	BE-8986

ERGO™ Square Tip Reamer Screwdriver with Rubber Grip 6 mm



BE-8980

6 mm	100 mm	27 mm	5	BE-8980

ERGO™ Hex Head Nut Drivers with Rubber Grip 4-7 mm



BE-6400M

4 mm	75 mm	20 mm	5	BE-6400M-4
5 mm	75 mm	20 mm	5	BE-6400M-5
5.5 mm	75 mm	20 mm	5	BE-6400M-5.5
7 mm	75 mm	20 mm	5	BE-6400M-7

ERGO™ Long Bore Hex Head Nut Drivers with Rubber Grip 3-14 mm



BE-78

3 mm	125 mm	20 mm	5	BE-7803
3.5 mm	125 mm	20 mm	5	BE-7835
4 mm	125 mm	20 mm	5	BE-7804
4.5 mm	125 mm	20 mm	5	BE-7845
5 mm	125 mm	20 mm	5	BE-7805
5.5 mm	125 mm	20 mm	5	BE-7855
6 mm	125 mm	20 mm	5	BE-7806
7 mm	125 mm	27 mm	5	BE-7807
8 mm	125 mm	27 mm	5	BE-7808
9 mm	125 mm	36 mm	5	BE-7809
10 mm	125 mm	36 mm	5	BE-7810
11 mm	125 mm	36 mm	5	BE-7811
12 mm	125 mm	36 mm	5	BE-7812
13 mm	125 mm	36 mm	5	BE-7813
14 mm	125 mm	36 mm	5	BE-7814

ERGO™ Flexible Shaft Hex Head Nut Drivers with Rubber Grip 6-8 mm



BE-76

Hex Size	Length	Shaft Diameter	Quantity	Part No.
6 mm	150 mm	27 mm	5	BE-7606
7 mm	150 mm	27 mm	5	BE-7607
8 mm	150 mm	27 mm	5	BE-7608

ERGO™ Bit Holder with Rubber Grip for 1/4" Hex Bit



BE-8577

Hex Size	Length	Shaft Diameter	Quantity	Part No.
1/4 in	118 mm	36 mm	5	BE-8577

ERGO™ Bit Holder Screwdriver with quick release system for 1/4" Hex Blades



BE-8575

Hex Size	Length	Quantity	Part No.
1/4 in	122 mm	1	BE-8575

1/4" Hex Blades for Slotted Head Screw - 100 mm



8020-2P - 8252-2P

Hex Size	Thickness	Quantity	Part No.
3.0 mm	0.5 mm	1	8020-2P
3.5 mm	0.6 mm	1	8030-2P
4.0 mm	0.8 mm	1	8040-2P
5.5 mm	1.0 mm	1	8242-2P
6.5 mm	1.2 mm	1	8252-2P

1/4" Hex Blades for Phillips Head Screw - 100 mm



8600-2P - 8630-2P

Hex Size	Quantity	Part No.
0	1	8600-2P
1	1	8610-2P
2	1	8620-2P
3	1	8630-2P

1/4" Hex Blades for Pozidriv Head Screw - 100 mm



8800-2P - 8830-2P

Hex Size	Quantity	Part No.
0	1	8800-2P
1	1	8810-2P
2	1	8820-2P
3	1	8830-2P



1/4" Hex Blades for TORX® Head Screw - 100 mm



8910-2P - 8940-2P



10	1	8910-2P	
15	1	8915-2P	
20	1	8920-2P	
25	1	8925-2P	
27	1	8927-2P	
30	1	8930-2P	
40	1	8940-2P	

1/4" Hex Blades for Phillips Head Screw - 300 mm



8610L-2P - 8620L-2P



1	1	8610L-2P	
2	1	8620L-2P	

1/4" Hex Blades for Hex Ball Head Screw - 100 mm



8703-2P - 8706-2P



3 mm	1	8703-2P	
4 mm	1	8704-2P	
5 mm	1	8705-2P	
6 mm	1	8706-2P	

1/4" Hex Blades for Pozidriv Head Screw - 300 mm



8810L-2P - 8820L-2P



1	1	8810L-2P	
2	1	8820L-2P	

1/4" Hex Blades for Slotted Head Screw - 300 mm



8040L-2P - 8252L-2P



0.8 mm	4.0 mm	1	8040L-2P
1.0 mm	5.5 mm	1	8242L-2P
1.2 mm	6.5 mm	1	8252L-2P

1/4" Hex Blades for TORX® Head Screw - 300 mm



8915L-2P - 8930L-2P



T15	1	8915L-2P	
T20	1	8920L-2P	
T25	1	8925L-2P	
T27	1	8927L-2P	
T30	1	8930L-2P	

1/4" Hex Blades for Phillips Head Screw - 400 mm



8620XL-1P - 8252XL-1P



2	1	8620XL-1P
3	1	8630XL-1P

1/4" Hex Blades for Pozidriv Head Screw - 400 mm



8820XL-1P - 8830XL-1P



2	1	8820XL-1P
3	1	8830XL-1P

1/4" Hex Blades for Slotted Head Screw - 400 mm



8252XL-1P - 8256XL-1P



1.2 mm	6.5 mm	1	8252XL-1P
--------	--------	---	-----------

ERGO™ Bit Holder Screwdrivers with quick release system and Interchangeable Blades Set - 7 Pcs



BE-8571



7	85 x 85 x 210 mm	1	BE-8571
---	------------------	---	---------

BE-8575

8242-2P, 8252-2P

8610-2P, 8620-2P

8810-2P, 8820-2P



ERGO™ Bit Holder Screwdriver with quick release system and Interchangeable Blades Set - 9 Pcs



BE-8572



9	85 x 80 x 210 mm	1	BE-8572
---	------------------	---	---------

BE-8575

8242-2P, 8252-2P

8610-2P, 8620-2P

8810-2P, 8820-2P

8910-2P, 8915-2P



ERGO™ Bit Holder Screwdrivers with quick release system and TORX® Interchangeable Blades Set - 8 Pcs



BE-8573



8	85 x 85 x 210 mm	1	BE-8573

BE-8575

8910-2P, 8915-2P, 8920-2P, 8925-2P, 8927-2P, 8930-2P, 8940-2P

ERGO™ Bit Holder Screwdrivers with quick release bit holder and Interchangeable Blades Set - 8 Pcs



BE-8574



8	85 x 85 x 210 mm	1	BE-8574

BE-8575

8610-2P, 8620-2P

8040-2P

8820-2P

8920-2P, 8925-2P, 8930-2P

ERGO™ Bit Holder Screwdriver with quick release system and Interchangeable Blades/Bits Set - 22 Pcs



BE-8576



23	1	BE-8576

BE-8575

8030-2P, 8040-2P, 8242-2P, 8252-2P

8810-2P, 8820-2P, 8830-2P

8610-2P, 8620-2P, 8630-2P

8910-2P, 8915-2P, 8925-2P, 8930-2P, 8940-2P

59S/H2, 59S/H3, 59S/H5, 59S/H4, 59S/H6

59S/H8

ERGO™ SCREWDRIVERS WITH IMPACT GRIP

ERGO™ Through Blade Slotted/Phillips/Hex Screwdriver Set with Impact Grip - 6 Pcs



BE-9881TB



6	1	BE-9881TB

BE-8135TB, BE-8145TB, BE-8150TB, BE-8155TB

BE-8610TB, BE-8620TB

ERGO™ Through Blade Slotted/Pozidriv/Hex Screwdriver Set with Impact Grip - 6 Pcs



BE-9882TB



6



1 BE-9882TB

BE-8135TB, BE-8145TB, BE-8150TB, BE-8155TB



BE-8810TB, BE-8820TB



ERGO™ Through Blade TORX®/Hex Screwdriver Set with Impact Grip - 5 Pcs



BE-9885TB



5



1 BE-9885TB

BE-8915TB, BE-8920TB, BE-8925TB, BE-8930TB, BE-8940TB



ERGO™ Through Blade Slotted Screwdrivers with Impact Grip 3.5-6.5 mm



BE-8135TB - BE-8262TB

Blade Width	Length	Tip Length	Quantity	Part Number
3.5 mm	75 mm	27 mm	10	BE-8135TB
4.5 mm	100 mm	27 mm	10	BE-8145TB
5.5 mm	100 mm	27 mm	10	BE-8150TB
6.5 mm	125 mm	36 mm	5	BE-8155TB

Blade Width	Length	Tip Length	Quantity	Part Number
8 mm	150 mm	36 mm	10	BE-8256TB
10 mm	175 mm	36 mm	10	BE-8258TB
12 mm	200 mm	36 mm	10	BE-8262TB
3.5 mm	75 mm	27 mm	1	SBE-8135TB
4.5 mm	100 mm	27 mm	1	SBE-8145TB
5.5 mm	100 mm	27 mm	1	SBE-8150TB
6.5 mm	125 mm	36 mm	1	SBE-8155TB

ERGO™ Through Blade Phillips Screwdrivers with Impact Grip PH1-PH4



BE-8610TB - BE-8624TB

Tip Size	Length	Tip Length	Quantity	Part Number
PH 1	100 mm	27 mm	10	BE-8610TB
PH 2	125 mm	36 mm	10	BE-8620TB
PH 3	150 mm	36 mm	10	BE-8623TB
PH 4	175 mm	36 mm	10	BE-8624TB
PH 1	100 mm	27 mm	1	SBE-8610TB
PH 2	125 mm	36 mm	1	SBE-8620TB

ERGO™ Through Blade Pozidriv Screwdrivers with Impact Grip PZ1-PZ4



BE-8810TB - BE-8824TB

Tip Size	Length	Tip Length	Quantity	Part Number
PZ 1	100 mm	27 mm	10	BE-8810TB
PZ 2	125 mm	36 mm	10	BE-8820TB
PZ 3	150 mm	36 mm	10	BE-8823TB
PZ 4	175 mm	36 mm	10	BE-8824TB
PZ 1	100 mm	27 mm	1	SBE-8810TB
PZ 2	125 mm	36 mm	1	SBE-8820TB



ERGO™ Through Blade TORX® Screwdrivers with Impact Grip T10-T40



BE-8910TB - BE-8940TB

T 10		75 mm	27 mm	5	BE-8910TB
T 15		100 mm	27 mm	5	BE-8915TB
T 20		100 mm	27 mm	5	BE-8920TB
T 25		100 mm	27 mm	5	BE-8925TB
T 27		125 mm	27 mm	5	BE-8927TB
T 30		150 mm	36 mm	5	BE-8930TB
T 40		150 mm	36 mm	5	BE-8940TB
T 15		100 mm	27 mm	1	SBE-8915TB
T 20		100 mm	27 mm	1	SBE-8920TB
T 25		100 mm	27 mm	1	SBE-8925TB
T 30		150 mm	36 mm	1	SBE-8930TB
T 40		150 mm	36 mm	1	SBE-8940TB

BAHCOFIT SCREWDRIVERS WITH GROOVED RUBBER GRIP

BahcoFit Slotted/Phillips Screwdriver Set with Rubber Grip - 2 Pcs



B219.002

2	1	B219.002

B191.040.100		
B192.001.100		

BahcoFit Slotted/Phillips Screwdriver Set with Rubber Grip - 2 Pcs



B219.012

2	1	B219.012

BAHCO

B190.055.125		
B192.002.125		

BahcoFit Slotted/Phillips Screwdriver Set with Rubber Grip - 4 Pcs



B219.004

4	1	B219.004

B191.030.100, B191.055.125		
B192.001.100, B192.002.125		

BahcoFit Phillips Screwdriver Set with Rubber Grip - 4 Pcs



B219.014

4	1	B219.014

B192.000.075, B192.001.100, B192.002.125, B192.003.150		
--	--	--

BahcoFit Slotted/Phillips Screwdriver Set with Rubber Grip - 5 Pcs



B219.005



5

1 B219.005

B191.030.075, B191.040.100



B190.055.125



B192.001.100, B192.002.125



BahcoFit Slotted/Pozidriv Screwdriver Set with Rubber Grip - 5 Pcs



B219.015



5

1 B219.015

B191.030.075, B191.040.100



B190.055.125



B193.001.100, B193.002.125



BahcoFit TORX® Screwdriver Set with Rubber Grip - 5 Pcs



B219.025



5

1 B219.025

B194.010.075, B194.015.100, B194.020.100, B194.025.125,
B194.030.150



BahcoFit Tamper-Resistant TORX® Screwdriver Set with Rubber Grip - 5 Pcs



B219.035



5

1 B219.035

B141.010.075, B141.015.100, B141.020.100, B141.025.125,
B141.030.150



BahcoFit Slotted Screwdriver Set with Rubber Grip - 5 Pcs



B219.045



5

1 B219.045

B191.030.100, B191.040.125



B190.055.125, B190.065.150, B190.080.175



BahcoFit Slotted/Phillips Screwdriver Set with Rubber Grip - 6 Pcs



B219.006



6

1 B219.006

B191.030.075, B191.040.100



B190.055.125, B190.065.125



B192.001.100, B192.002.125



BahcoFit Slotted/Pozidriv Screwdriver Set with Rubber Grip - 6 Pcs



B219.016



6

1 B219.016

B191.030.075, B191.040.100



B190.055.125, B190.065.125



B193.001.100, B193.002.125



BahcoFit Slotted/Phillips/Pozidriv Screwdriver Set with Rubber Grip - 6 Pcs



B219.026



6

1 B219.026

B191.030.075, B191.040.100



B192.001.100, B192.002.125



B193.001.100, B193.002.125



BahcoFit Pozidriv/TORX® Screwdriver Set with Rubber Grip - 7 Pcs



B219.007



7

1 B219.007

B193.001.100, B193.002.125



B194.010.075, B194.015.100, B194.020.100, B194.025.125,
B194.030.150



BahcoFit Slotted/Phillips Screwdriver Set with Rubber Grip - 7 Pcs



B219.017



7

1 B219.017

B191.035.100, B191.040.100



B190.055.125, B190.065.150, B190.080.150

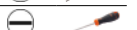

B192.001.100, B192.002.125



BahcoFit TORX® Screwdriver Set with Rubber Grip - 7 Pcs



B219.027



7

1 B219.027

B194.010.075, B194.015.100, B194.020.100, B194.025.125,
B194.027.125, B194.030.150, B194.040.150



BahcoFit Slotted/Phillips Screwdriver Set with Rubber Grip - 8 Pcs



B219.008



8

1 B219.008

B191.040.100, B191.055.125



B190.065.150, B190.080.175



B192.001.100, B192.002.125



B195.060.025



B195.002.025



BahcoFit Slotted/Phillips/Pozidriv/TORX® Screwdriver Set with Rubber Grip - 10 Pcs



B219.110

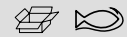

10

1 B219.110

B190.055.100



B192.002.125



B193.002.125



B194.010.075, B194.015.100, B194.020.100



B196.025.075, B196.040.100



B142.001.080



806-1-1



BahcoFit Torx® Screwdriver Set with Rubber Grip - 10 pcs



B219.210



10

4.5 x 33 x 17 mm

1 B219.210

B194.006.075, B194.008.075, B194.009.075, B194.010.075,
B194.015.100, B194.020.100, B194.025.125, B194.027.125,
B194.030.150, B194.040.150



BahcoFit Slotted/Phillips/Pozidriv/Robertson Screwdriver Set with Rubber Grip - 10 Pcs



B219.010



10 1 B219.010

B191.030.075		
B190.055.100, B190.065.125, B190.080.150		
B192.001.100, B192.002.125, B192.003.150		
B195.902.025		
B144.001.100, B144.002.125		

BahcoFit Slotted Flat Screwdrivers with Rubber Grip 4.0-14 mm



B190

Bit Size	Length	Tip Length	Quantity	Part Number
4 mm	75 mm	24.5 mm	10	B190.040.075
4 mm	100 mm	24.5 mm	10	B190.040.100
5.5 mm	100 mm	30 mm	10	B190.055.100
5.5 mm	125 mm	30 mm	10	B190.055.125
6.5 mm	125 mm	34 mm	10	B190.065.125
6.5 mm	150 mm	34 mm	10	B190.065.150
8 mm	150 mm	34 mm	10	B190.080.150
8 mm	175 mm	34 mm	10	B190.080.175
10 mm	200 mm	34 mm	10	B190.100.200
12 mm	250 mm	34 mm	10	B190.120.250
14 mm	250 mm	34 mm	10	B190.140.250
4 mm	75 mm	24.5 mm	1	SB190.040.075
4 mm	100 mm	24.5 mm	1	SB190.040.100
5.5 mm	100 mm	30 mm	1	SB190.055.100
5.5 mm	125 mm	30 mm	1	SB190.055.125
6.5 mm	125 mm	34 mm	1	SB190.065.125
6.5 mm	150 mm	34 mm	1	SB190.065.150
8 mm	150 mm	34 mm	1	SB190.080.150
8 mm	175 mm	34 mm	1	SB190.080.175
10 mm	200 mm	34 mm	1	SB190.100.200
12 mm	250 mm	34 mm	1	SB190.120.250
14 mm	250 mm	34 mm	1	SB190.140.250

BahcoFit Slotted Straight Screwdrivers with Rubber Grip 2.5-6.5 mm



B191

Bit Size	Length	Tip Length	Quantity	Part Number
2.5 mm	75 mm	24.5 mm	10	B191.025.075
3 mm	75 mm	24.5 mm	10	B191.030.075
3 mm	100 mm	24.5 mm	10	B191.030.100
3 mm	200 mm	24.5 mm	10	B191.030.200
3.5 mm	100 mm	24.5 mm	10	B191.035.100
4 mm	100 mm	24.5 mm	10	B191.040.100
4 mm	125 mm	24.5 mm	10	B191.040.125
4 mm	250 mm	24.5 mm	10	B191.040.250
5.5 mm	125 mm	30 mm	10	B191.055.125
5.5 mm	150 mm	30 mm	10	B191.055.150
5.5 mm	300 mm	30 mm	10	B191.055.300
6.5 mm	150 mm	34 mm	10	B191.065.150
6.5 mm	300 mm	34 mm	10	B191.065.300
2.5 mm	75 mm	24.5 mm	1	SB191.025.075
3 mm	75 mm	24.5 mm	1	SB191.030.075
3 mm	100 mm	24.5 mm	1	SB191.030.100
3 mm	200 mm	24.5 mm	1	SB191.030.200
3.5 mm	100 mm	24.5 mm	1	SB191.035.100
4 mm	100 mm	24.5 mm	1	SB191.040.100
4 mm	125 mm	24.5 mm	1	SB191.040.125
4 mm	250 mm	24.5 mm	1	SB191.040.250
5.5 mm	125 mm	30 mm	1	SB191.055.125
5.5 mm	150 mm	30 mm	1	SB191.055.150
5.5 mm	300 mm	30 mm	1	SB191.055.300
6.5 mm	150 mm	34 mm	1	SB191.065.150
6.5 mm	300 mm	34 mm	1	SB191.065.300

BahcoFit Stubby Slotted Straight Screwdrivers with Rubber Grip 4.0-6.0 mm



B195

Bit Size	Length	Tip Length	Quantity	Part Number
4 mm	25 mm	33 mm	10	B195.040.025
5.0 mm	25 mm	33 mm	10	B195.050.025
6 mm	25 mm	33 mm	10	B195.060.025
4 mm	25 mm	33 mm	1	SB195.040.025
5 mm	25 mm	33 mm	1	SB195.050.025
6 mm	25 mm	33 mm	1	SB195.060.025

BahcoFit Phillips Screwdrivers with Rubber Grip PH0-PH4



B192



PH0	75 mm	24.5 mm	10	B192.000.075
PH0	200 mm	24.5 mm	10	B192.000.200
PH1	100 mm	30 mm	10	B192.001.100
PH1	250 mm	30 mm	10	B192.001.250
PH2	125 mm	34 mm	10	B192.002.125
PH2	150 mm	34 mm	10	B192.002.150
PH2	300 mm	34 mm	10	B192.002.300
PH3	150 mm	34 mm	10	B192.003.150
PH4	200 mm	34 mm	10	B192.004.200
PH0	75 mm	24.5 mm	1	SB192.000.075
PH0	200 mm	24.5 mm	1	SB192.000.200
PH1	100 mm	30 mm	1	SB192.001.100
PH1	250 mm	30 mm	1	SB192.001.250
PH2	125 mm	34 mm	1	SB192.002.125
PH2	300 mm	34 mm	1	SB192.002.300
PH3	150 mm	34 mm	1	SB192.003.150
PH4	200 mm	34 mm	1	SB192.004.200

BahcoFit Pozidriv Screwdrivers with Rubber Grip PZ0-PZ4



B193



PZ0	75 mm	24.5 mm	10	B193.000.075
PZ1	100 mm	30 mm	10	B193.001.100
PZ2	125 mm	34 mm	10	B193.002.125
PZ3	150 mm	34 mm	10	B193.003.150
PZ4	200 mm	34 mm	10	B193.004.200
PZ0	75 mm	24.5 mm	1	SB193.000.075
PZ1	100 mm	30 mm	1	SB193.001.100
PZ2	125 mm	34 mm	1	SB193.002.125
PZ3	150 mm	34 mm	1	SB193.003.150
PZ4	200 mm	34 mm	1	SB193.004.200

BahcoFit Stubby Pozidriv Screwdrivers with Rubber Grip PZ1-PZ2



BahcoFit Stubby Phillips Screwdrivers with Rubber Grip PH1-PH2



B195PH



PH1	25 mm	33 mm	10	B195.001.025
PH2	25 mm	33 mm	10	B195.002.025
PH1	25 mm	33 mm	1	SB195.001.025
PH2	25 mm	33 mm	1	SB195.002.025



B195PZ



PZ1	25 mm	33 mm	10	B195.901.025
PZ2	25 mm	33 mm	10	B195.902.025
PZ1	25 mm	33 mm	1	SB195.901.025
PZ2	25 mm	33 mm	1	SB195.902.025



BahcoFit TORX® Screwdrivers with Rubber Grip T4-T45



B194



T4	75 mm	24.5 mm	10	B194.004.075
T5	75 mm	24.5 mm	10	B194.005.075
T6	75 mm	24.5 mm	10	B194.006.075
T7	75 mm	24.5 mm	10	B194.007.075
T8	75 mm	24.5 mm	10	B194.008.075
T9	75 mm	24.5 mm	10	B194.009.075
T10	75 mm	24.5 mm	10	B194.010.075
T15	100 mm	24.5 mm	10	B194.015.100
T20	100 mm	24.5 mm	10	B194.020.100
T25	125 mm	30 mm	10	B194.025.125
T27	125 mm	30 mm	10	B194.027.125
T30	150 mm	34 mm	10	B194.030.150
T40	150 mm	34 mm	10	B194.040.150
T45	150 mm	34 mm	5	B194.045.150
T4	75 mm	24.5 mm	1	SB194.004.075
T5	75 mm	24.5 mm	1	SB194.005.075
T6	75 mm	24.5 mm	1	SB194.006.075
T7	75 mm	24.5 mm	1	SB194.007.075
T8	75 mm	24.5 mm	1	SB194.008.075
T9	75 mm	24.5 mm	1	SB194.009.075
T10	75 mm	24.5 mm	1	SB194.010.075
T15	100 mm	24.5 mm	1	SB194.015.100
T20	100 mm	24.5 mm	1	SB194.020.100
T25	125 mm	30 mm	1	SB194.025.125
T27	125 mm	30 mm	1	SB194.027.125
T30	150 mm	34 mm	1	SB194.030.150
T40	150 mm	34 mm	1	SB194.040.150
T45	150 mm	34 mm	1	SB194.045.150

BahcoFit Tamper-Resistant TORX® Screwdrivers with Rubber Grip TR7-TR40



B141



TR7	75 mm	24.5 mm	5	B141.007.075
TR8	75 mm	24.5 mm	5	B141.008.075
TR9	75 mm	24.5 mm	5	B141.009.075
TR10	75 mm	24.5 mm	5	B141.010.075
TR15	100 mm	24.5 mm	5	B141.015.100
TR20	100 mm	24.5 mm	5	B141.020.100
TR25	125 mm	30 mm	5	B141.025.125
TR27	125 mm	30 mm	5	B141.027.125
TR30	150 mm	34 mm	5	B141.030.150
TR40	150 mm	34 mm	5	B141.040.150
TR7	75 mm	24.5 mm	1	SB141.007.075
TR8	75 mm	24.5 mm	1	SB141.008.075
TR9	75 mm	24.5 mm	1	SB141.009.075

BAHCO

TR10	75 mm	24.5 mm	1	SB141.010.075
TR15	100 mm	24.5 mm	1	SB141.015.100
TR20	100 mm	24.5 mm	1	SB141.020.100
TR25	125 mm	30 mm	1	SB141.025.125
TR27	125 mm	30 mm	1	SB141.027.125
TR30	150 mm	34 mm	1	SB141.030.150
TR40	150 mm	34 mm	1	SB141.040.150

BahcoFit Hex Ball End Screwdrivers with Rubber Grip Hex2-8 mm



B143



2	100 mm	24.5 mm	5	B143.020.100
2.5	100 mm	24.5 mm	10	B143.025.100
3	100 mm	24.5 mm	10	B143.030.100
4	100 mm	24.5 mm	10	B143.040.100
5	100 mm	30 mm	10	B143.050.100
6	125 mm	34 mm	10	B143.060.125
8	150 mm	34 mm	5	B143.080.150
2	100 mm	24.5 mm	1	SB143.020.100
2.5	100 mm	24.5 mm	1	SB143.025.100
3	100 mm	24.5 mm	1	SB143.030.100
4	100 mm	24.5 mm	1	SB143.040.100
5	100 mm	30 mm	1	SB143.050.100
6	125 mm	34 mm	1	SB143.060.125
8	150 mm	34 mm	1	SB143.080.150

BahcoFit Robertson Square Screwdrivers with Rubber Grip #1-#3



B144



#1	100 mm	24.5 mm	5	B144.001.100
#2	125 mm	30 mm	5	B144.002.125
#3	150 mm	34 mm	5	B144.003.150
#1	100 mm	24.5 mm	1	SB144.001.100
#2	125 mm	30 mm	1	SB144.002.125
#3	150 mm	34 mm	1	SB144.003.150

BahcoFit Awl with Rubber Grip for Pre-Punching/Drilling Holes 6 mm



B145

Ø	Length	Tip Length	Icons	Part No.
6 mm	100 mm	30 mm	5	B145.006.100
6 mm	100 mm	30 mm	1	SB145.006.100

BahcoFit Reamers with Rubber Grip for Enlarging/Drilling Holes 6 mm



B146

Ø	Length	Tip Length	Icons	Part No.
6 mm	100 mm	30 mm	5	B146.006.100
6 mm	100 mm	30 mm	1	SB146.006.100

BahcoFit Stubby Awl with Rubber Grip 6 mm



B195Awl

Ø	Length	Tip Length	Icons	Part No.
4 mm	50 mm	33 mm	5	B195.006.050
4 mm	50 mm	33 mm	1	SB195.006.050

BahcoFit Hex Head Nut Drivers with Rubber Grip 4-14 mm



B198

Ø	Length	Tip Length	Icons	Part No.
4 mm	125 mm	24.5 mm	5	B198.040.125
4.5 mm	125 mm	24.5 mm	5	B198.045.125
5 mm	150 mm	30 mm	5	B198.050.150
5.5 mm	150 mm	30 mm	5	B198.055.150
6 mm	150 mm	30 mm	5	B198.060.150
6 mm	150 mm	34 mm	5	B198.060.150F
7 mm	150 mm	34 mm	5	B198.070.150
7 mm	150 mm	34 mm	5	B198.070.150F
8 mm	150 mm	34 mm	5	B198.080.150
8 mm	150 mm	34 mm	5	B198.080.150F
9 mm	150 mm	34 mm	5	B198.090.150
10 mm	150 mm	34 mm	5	B198.100.150
11 mm	150 mm	34 mm	5	B198.110.150
12 mm	150 mm	34 mm	5	B198.120.150
13 mm	150 mm	34 mm	5	B198.130.150
14 mm	150 mm	34 mm	5	B198.140.150
4 mm	125 mm	24.5 mm	1	SB198.040.125
4.5 mm	125 mm	24.5 mm	1	SB198.045.125
5 mm	150 mm	30 mm	1	SB198.050.150
5.5 mm	150 mm	30 mm	1	SB198.055.150
6 mm	150 mm	30 mm	1	SB198.060.150
6 mm	150 mm	34 mm	1	SB198.060.150F
7 mm	150 mm	34 mm	1	SB198.070.150
7 mm	150 mm	34 mm	1	SB198.070.150F
8 mm	150 mm	34 mm	1	SB198.080.150
8 mm	150 mm	34 mm	1	SB198.080.150F
9 mm	150 mm	34 mm	1	SB198.090.150
10 mm	150 mm	34 mm	1	SB198.100.150
11 mm	150 mm	34 mm	1	SB198.110.150
12 mm	150 mm	34 mm	1	SB198.120.150
13 mm	150 mm	34 mm	1	SB198.130.150
14 mm	150 mm	34 mm	1	SB198.140.150



SCREWDRIVERS WITH RUBBERED GRIP

Slotted/Phillips Screwdriver Set with Rubber Grip - 3 Pcs



600-3



3

1 600-3

613-3-100



611-5.5-125



615-1-100

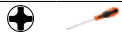

Slotted/Phillips Screwdriver Set with Rubber Grip - 4 Pcs



602-4-LA



4

1 602-4-LA

613-3-100



611-5.5-100



615-1-100, 615-2-125



Slotted/Phillips Screwdriver Set with Rubber Grip - 5 Pcs



604-5



5

1 604-5

613-3-100



611-4-100, 611-6.5-125



615-1-100, 615-2-125



TORX® Screwdriver Set with Rubber Grip - 5 Pcs



612-5



5

1 612-5

618-10-75, 618-15-100, 618-20-100, 618-25-125, 618-30-150



Slotted/Phillips/Pozidriv Screwdriver Set with Rubber Grip 3-4 mm/
PH1-PH2/PZ1-PZ2 - 6 Pcs



605-6

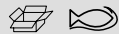

6

1 605-6

613-3-75, 613-4-100



615-1-100, 615-2-125



616-1-100, 616-2-125



Slotted/Phillips Screwdriver Set with Rubber Grip 5.5-6.5 mm/3-4 mm/
PH1-PH2 - 6 Pcs



606-6



6

1 606-6

611-5.5-100, 611-6.5-125



613-3-75, 613-4-100



615-1-100, 615-2-125



Slotted/Pozidriv Screwdriver Set with Rubber Grip - 6 Pcs



610-6

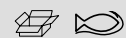

6

1 610-6

611-5.5-100, 611-6.5-125



613-3-75, 613-4-100



616-1-100, 616-2-125



Slotted/Phillips/Robertson Screwdriver Set with Rubber Grip - 10 Pcs



605-10-PC-AU



10

1 605-10-PC-AU

Robertson R1x100; R2x100; Stubby PZ2 X 25

611-5.5-100, 611-6.5-125, 611-8-150



613-3-75



615-1-100, 615-2-125, 615-3-150



616-2-25, 619-1-100, 619-2-100



Slotted Flat Screwdrivers with Rubber Grip 3.5-10 mm



611

Tip Size	Length	Shaft Diameter	Quantity	Part No.
3.5 mm	75 mm	25 mm	10	611-3.5-75
3.5 mm	100 mm	25 mm	10	611-3.5-100
4.0 mm	75 mm	25 mm	10	611-4-75
4.0 mm	100 mm	25 mm	10	611-4-100
5.5 mm	100 mm	30 mm	10	611-5.5-100
5.5 mm	125 mm	30 mm	10	611-5.5-125
6.5 mm	25 mm	35 mm	10	611-6.5-25
6.5 mm	125 mm	35 mm	10	611-6.5-125
6.5 mm	150 mm	35 mm	10	611-6.5-150
8.0 mm	150 mm	35 mm	10	611-8-150
8.0 mm	175 mm	35 mm	10	611-8-175
10.0 mm	200 mm	35 mm	10	611-10-200

Slotted Straight Screwdrivers with Rubber Grip 3.0 -6.5 mm



613

Tip Size	Length	Shaft Diameter	Quantity	Part No.
3.0 mm	75 mm	25 mm	10	613-3-75
3.0 mm	100 mm	25 mm	10	613-3-100
3.5 mm	100 mm	25 mm	10	613-3.5-100
4.0 mm	100 mm	25 mm	10	613-4-100
4.0 mm	125 mm	25 mm	10	613-4-125
5.5 mm	150 mm	30 mm	10	613-5.5-150
6.5 mm	150 mm	35 mm	10	613-6.5-150

Phillips Screwdrivers with Rubber Grip PH0-PH3



615

Tip Size	Length	Shaft Diameter	Quantity	Part No.
PH 0	75 mm	25 mm	10	615-0-75
PH 1	100 mm	30 mm	10	615-1-100
PH 2	25 mm	35 mm	10	615-2-25



PH 2
PH 3



125 mm
150 mm



35 mm
35 mm



10 615-2-125
10 615-3-150

Pozidriv Screwdrivers with Rubber Grip PZ0-PZ3



616

Tip Size	Length	Shaft Diameter	Quantity	Part No.
PZ 0	75 mm	25 mm	10	616-0-75
PZ 1	100 mm	30 mm	10	616-1-100
PZ 2	125 mm	35 mm	10	616-2-125
PZ 3	150 mm	35 mm	10	616-3-150

TORX® Screwdrivers with Rubber Grip T10-T40



618

Tip Size	Length	Shaft Diameter	Quantity	Part No.
T 10	75 mm	25 mm	10	618-10-75
T 15	100 mm	25 mm	10	618-15-100
T 20	100 mm	25 mm	10	618-20-100
T 25	125 mm	30 mm	10	618-25-125
T 27	125 mm	30 mm	10	618-27-125
T 30	150 mm	35 mm	10	618-30-150
T 40	150 mm	35 mm	10	618-40-150

SCREWDRIVERS WITH RATCHETING GRIP

1/4" Bit Holder Ratcheting Screwdrivers



808050

1/4"	125 mm	41.6 mm	50	808050

1/4" Heavy-Duty Bit Set for Nut Drivers & Slotted/Phillips/Pozidriv/Torx[®]/Hex Bits with Ratcheting Screwdriver Holder - 36 pcs



59/S36BCR

36	43 x 135 x 215 mm	6	59/S36BCR

Phillips/Pozidriv/Slotted LED Light Ratcheting Screwdriver with Ratcheting Grip



808050L

1/4 in	10x35 mm	808050L	25	808050L
			1	808050L-SP1

1/4" Ratcheting Bit Screwdriver with Pistol Handle



808050P

1/4 in	135 mm	40 mm	50	808050P

1/4" Ratcheting Bit Screwdriver Set with Pistol Handle - 25 Pcs



808050P-

70 x 158 x 285 mm	10	808050P-25	

1/4" Bit Holder Stubby T-Handle Ratcheting Screwdrivers



808050TS

1/4 in	68 mm	91 mm	1	808050TS



1/4" Bit Holder Stubby Ratcheting Screwdrivers



808050S

1/4 in	68 mm	41 mm	25	808050S

Stubby Ratcheting Screwdriver Set - 18 Pcs



808050S-18

46 x 130 x 195 mm	30	808050S-18

Stubby Ratcheting Screwdriver Set - 22-Pcs



808050S-22

46 x 130 x 195 mm	30	808050S-22

SCREWDRIVERS WITH PRECISION GRIP

Slotted/Phillips Screwdriver Set with Precision Grip 1.5-3.0mm/PH0-PH1 - 6 Pcs



706-1

6	1	706-1		

700-2-50, 700-2.5-50, 700-1.5-50, 700-3-50
701-0-50, 701-1-75

Slotted/Phillips Screwdriver Set with Precision Grip 1.0-1.8 mm/PH0-PH0 - 6 Pcs



706-2

6	1	706-2		

700-1.5-50, 700-1.2-50, 700-1-50, 700-1.8-50
701-00-50, 701-0-50

Slotted Screwdriver Set with Precision Grip 1.0 - 2.5 mm - 6 Pcs



706-3



6



1 706-3

700-2.5-50, 700-2-50, 700-1.8-50, 700-1.5-50, 700-1.2-50, 700-1-50

Slotted/Phillips/TORX® Screwdriver Set with Precision Grip - 7 Pcs



706-4



7



1 706-4

700-2.5-50, 700-3.5-75, 700-1.5-50

701-1-75, 701-0-50

703-8-50, 703-6-50

Slotted/Phillips/Pozidriv/TORX/Hex Screwdriver Set with Precision Grip - 24 Pcs



706-5



24



1 706-5

700-3-50, 700-2-50, 700-3.5-75, 700-4-75, 700-1.5-50, 700-1.2-50, 700-1-50, 700-1.8-50

701-00-50, 701-0-50, 701-1-75

702-1-75, 702-0-50

703-6-50, 703-9-50, 703-10-50, 703-7-50, 703-8-50, 703-15-75, 703-20-75

704-2.5-50, 704-3-75, 704-1.5-50, 704-2-50

Slotted Screwdrivers with Precision Grip 1.0-4.0 mm



700



Tip Size	Length	Shaft Diameter	Quantity	Part No.
1 mm	50 mm	14 mm	5	700-1-50
1.2 mm	50 mm	14 mm	5	700-1.2-50
1.5 mm	50 mm	14 mm	5	700-1.5-50
1.8 mm	50 mm	14 mm	5	700-1.8-50
2 mm	50 mm	14 mm	5	700-2-50
2.5 mm	50 mm	14 mm	5	700-2.5-50
3 mm	50 mm	14 mm	5	700-3-50
3 mm	100 mm	14 mm	5	700-3-100
3 mm	200 mm	14 mm	5	700-3-200
3.5 mm	75 mm	14 mm	5	700-3.5-75
4 mm	75 mm	14 mm	5	700-4-75
4 mm	250 mm	14 mm	5	700-4-250



Phillips Screwdrivers with Precision Grip PH00-PH1



701



PH 00	50 mm	14 mm	5	701-00-50	
PH 0	50 mm	14 mm	5	701-0-50	
PH 0	200 mm	14 mm	5	701-0-200	
PH 1	75 mm	14 mm	5	701-1-75	
PH 1	250 mm	14 mm	5	701-1-250	

Hex Ball Screwdrivers with Precision Grip 1.5-3 mm 3/32"



704

1.5	50 mm	14 mm	5	704-1.5-50	
2	50 mm	14 mm	5	704-2-50	
2.5	50 mm	14 mm	5	704-2.5-50	
3	75 mm	14 mm	5	704-3-75	
3/32	75 mm	14 mm	5	704Z-3/32	

Pozidriv Screwdrivers with Precision Grip PZ0-PZ1



702



PZ 0	50 mm	14 mm	5	702-0-50	
PZ 1	75 mm	14 mm	5	702-1-75	

Watchmakers Slotted Screwdrivers with Precision Grip and 4 Interchangeable Blades



510034

0.25x1.5, 0.3x2, 0.4x2.5, 0.5x3	8.5 mm	10	510034		

TORX® Screwdrivers with Precision Grip T4-T20



703



T 4	50 mm	14 mm	5	703-4-50	
T 5	50 mm	14 mm	5	703-5-50	
T 6	50 mm	14 mm	5	703-6-50	
T 7	50 mm	14 mm	5	703-7-50	
T 8	50 mm	14 mm	5	703-8-50	
T 9	50 mm	14 mm	5	703-9-50	
T 10	50 mm	14 mm	5	703-10-50	
T 15	75 mm	14 mm	5	703-15-75	
T 20	75 mm	14 mm	5	703-20-75	

Watchmakers Slotted Screwdrivers with Precision Grip 2.5-4.5 mm



2784

2.5 mm	6 mm	100 mm	1	2784-2.5	
3.5 mm	6 mm	104 mm	1	2784-3.5	
4.5 mm	10 mm	110 mm	1	2784-4.5	

Watchmakers Slotted Screwdriver Set with Precision Grip 0.6-2.5 mm - 5 Pcs



98505

	 
5	5 98505

Watchmakers Slotted Screwdriver Set with Precision Grip 1.0-3.5 mm - 6 Pcs



510031

	 
6	5 510031

Watchmakers Phillips Screwdriver Set with Precision Grip PH000-PH0 - 3 Pcs



510033

	 
3	5 510033

PH000; PH00; PH0

SCREWDRIVERS WITH T-HANDLE GRIP

Hex Screwdriver Set with T-Handle Grip - 6 Pcs



903T-1

	 
6	1 903T-1

900T-030-100, 900T-040-150, 900T-050-150, 900T-060-200, 900T-080-200, 900T-100-200

TORX® Screwdriver Set with T-Handle Grip - 6 Pcs



903T-2

	 
6	1 903T-2

901T-015-150, 901T-020-150, 901T-010-100, 901T-030-200, 901T-040-200, 901T-025-150



Hex Nut Driver Set with T-Handle Grip - 6 Pcs



903T-3



6

1 903T-3

902T-060-150, 902T-070-175, 902T-050-150, 902T-080-175, 902T-100-175, 902T-130-175

Hex Screwdrivers with T-Handle Grip 2-10 mm



900T



2 mm	100 mm	50 mm	5	900T-020-100
2.5 mm	100 mm	50 mm	5	900T-025-100
3 mm	100 mm	50 mm	5	900T-030-100
4 mm	138 mm	50 mm	5	900T-040-150
5 mm	138 mm	60 mm	5	900T-050-150
6 mm	185 mm	60 mm	5	900T-060-200
8 mm	185 mm	60 mm	5	900T-080-200
10 mm	185 mm	60 mm	5	900T-100-200

TORX® Screwdrivers with T-Handle Grip T6-T50



901T



T 6	100 mm	50 mm	5	901T-006-100
T 7	100 mm	50 mm	5	901T-007-100
T 8	100 mm	50 mm	5	901T-008-100
T 9	100 mm	50 mm	5	901T-009-100
T 10	100 mm	50 mm	5	901T-010-100
T 15	138 mm	50 mm	5	901T-015-150
T 20	138 mm	50 mm	5	901T-020-150
T 25	138 mm	60 mm	5	901T-025-150
T 27	138 mm	60 mm	5	901T-027-150
T 30	185 mm	60 mm	5	901T-030-200

BAHCO



T 40	185 mm	60 mm	5	901T-040-200
T 45	185 mm	60 mm	5	901T-045-200
T 50	185 mm	60 mm	5	901T-050-200

Hex Head Nut Drivers with T-Handle Grip 5-13 mm



902T



5 mm	136 mm	50 mm	5	902T-050-150
5.5 mm	136 mm	50 mm	5	902T-055-150
6 mm	136 mm	50 mm	5	902T-060-150
7 mm	160 mm	60 mm	5	902T-070-175
8 mm	160 mm	60 mm	5	902T-080-175
9 mm	160 mm	60 mm	5	902T-090-175
10 mm	160 mm	60 mm	5	902T-100-175
11 mm	160 mm	60 mm	5	902T-110-175
12 mm	160 mm	60 mm	5	902T-120-175
13 mm	160 mm	60 mm	5	902T-130-175

Socket Drivers with T-Handle Grip 1/4"



905T



1/4"	45 mm	60 mm	5	905T-060-100
------	-------	-------	---	--------------

SCREWDRIVERS WITH 1/4" BIT HOLDERS

1/4" x 125 mm Magnetic Bit Holders



B705



1/4" in	125 mm	30 mm	5	B705.1/4.125
1/4" in	125 mm	30 mm	1	SB705.1/4.125

1/4" Hex Head T-Handle Bit Holders



904T

1/4 in	150 mm	5	904T-060-150



1/4" Bit Holder Screwdrivers for Phillips/Pozidriv/Slotted/TORX® Head Screw



808050A/TORX

1/4 in	115 mm	40 mm	1	808050A
1/4 in	115 mm	40 mm	50	808050TORX



Phillips Screwdrivers with Wooden Handle PH1-PH3



9778

PH 1	80 mm	24 mm	10	9778-1
PH 2	110 mm	27 mm	10	9778-2
PH 3	150 mm	30 mm	5	9778-3



Pozidriv Screwdrivers with Wooden Handle PZ1-PZ2



9778PZD

PZ 1	80 mm	24 mm	10	9778PZD-1
PZ 2	110 mm	27 mm	10	9778PZD-2



Slotted/Phillips Screwdriver Set with Wooden Handle - 6 Pcs



SCREWDRIVERS WITH WOODEN OR PLASTIC GRIP

Slotted Flat Screwdrivers with Wooden Handle 3.5-10 mm



9710

3.5 mm	75 mm	22 mm	10	9710-3.5-75
5.5 mm	100 mm	24 mm	10	9710-5.5-100
6.5 mm	125 mm	27 mm	10	9710-6.5-125
8.0 mm	150 mm	30 mm	5	9710-8-150
10.0 mm	175 mm	32 mm	5	9710-10-175



9710/S6

6	1	9710/S6

0,8x4,5x90

9710-4.5-90

9710-5.5-100, 9710-6.5-125, 9710-8-150

9778-1, 9778-2



Slotted and Phillips Reversible Blade Screwdrivers



1019/1067



4,5 mm	PH 1	10	1067
6 mm	PH 2	10	1019

Slotted/Phillips Reversible blade Screwdriver with Plastic Handle 6.0 mm/PH2



8052



PH 2	80 mm	28 mm	5	8052
------	-------	-------	---	------

Stubby Slotted and Phillips Reversible Blade Screwdrivers



1016



6 mm	PH 2	10	1016
------	------	----	------

Reversible Blade Phillips/Slotted Screwdriver Set



6



PH 0, PH 1, PH 2	3,5-5,0-6,5 mm	1	6
------------------	----------------	---	---

Slotted Straight Tipped Screwdrivers with Impact Grip 2.5 x 250 mm



9715



14.0 mm	250 mm	32 mm	5	9715-14-250
---------	--------	-------	---	-------------

Precision Slotted Screwdrivers with Plastic Handle 2.0-3.0 mm



7372I



2.0 mm	63 mm	13 mm	10	7372I-2-63
2.5 mm	75 mm	13 mm	10	7372I-2.5-75
3.0 mm	80 mm	13 mm	10	7372I-3-80

ELECTRICAL TESTERS

150-250 V Voltage Testers with neon indicator



806



3.0 mm	65 mm	16 mm	6	806-1-1
3.5 mm	100 mm	17.5 mm	6	806-1-2

6-24V Auto Tester with neon light

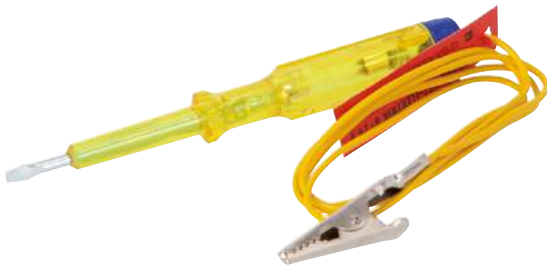

806-1-3



3 mm	45 mm	16 mm	6	806-1-3

150-250 V Voltage Tester, 3.5 mm, 77 mm blade with neon indicator



8045VDE



3.5 mm	77 mm	14 mm	10	8045VDE

150-250 V Voltage Tester, 3.5 mm, 42 mm blade with neon indicator



8045LVDE



3.5 mm	42 mm	16 mm	10	8045LVDE

ACCESSORIES

Magnetising and Demagnetising Boxes for Screwdriver Blades/ Tweezers



M780

29 x 52 x 50 mm	1	M780

Magnetizer and Demagnetizer for Screwdriver Blades/Tweezers/ Scissors



M781

22 x 125 x 40 mm	5	M781





BAHCO



L-Keys



HEXAGONAL TIPPED

Metric Hex L-Keys with Nickel Finish



1998M

Hex Size	Length	Qty	Part No.
1.5 mm	47 mm	10	1998M-1.5
2 mm	52 mm	10	1998M-2
2.5 mm	59 mm	10	1998M-2.5
3.0 mm	66 mm	10	1998M-3
4.0 mm	74 mm	10	1998M-4
5.0 mm	85 mm	10	1998M-5
6.0 mm	96 mm	10	1998M-6
7.0 mm	102 mm	10	1998M-7
8.0 mm	108 mm	10	1998M-8
9.0 mm	114 mm	5	1998M-9
10 mm	122 mm	10	1998M-10
12.0 mm	137 mm	5	1998M-12
14.0 mm	154 mm	1	1998M-14
17.0 mm	177 mm	1	1998M-17
19.0 mm	199 mm	1	1998M-19
22.0 mm	222 mm	1	1998M-22

Metric Hex L-Key Set with Nickel Finish - 6 Pcs



1998M/

Hex Size	Qty	Part No.
2, 2.5, 3, 4, 5, 6 mm	6	1998M/6T

1998M-4, 1998M-5, 1998M-6, 1998M-2.5, 1998M-2, 1998M-3

Metric Hex L-Key Set with Nickel Finish - 8 Pcs



1998M/8T

Hex Size	Qty	Part No.
2, 2.5, 3, 4, 5, 6, 7, 8 mm	8	1998M/8T

1998M-3, 1998M-2, 1998M-6, 1998M-7, 1998M-4, 1998M-5, 1998M-8, 1998M-2.5

Metric Hex L-Key Set with Nickel Finish - 10 Pcs



1998M/10T

Hex Size	Qty	Part No.
2, 2.5, 3, 4, 5, 6, 7, 8, 9, 10 mm	10	1998M/10T

1998M-5, 1998M-4, 1998M-7, 1998M-6, 1998M-2, 1998M-3, 1998M-2.5, 1998M-8, 1998M-9, 1998M-10

Metric Hex L-Key Set with Nickel Finish - 11 Pcs



1998M/11T

Hex Size	Qty	Part No.
2, 2.5, 3, 4, 5, 6, 7, 8, 9, 10, 12 mm	11	1998M/11T

1998M-5, 1998M-4, 1998M-7, 1998M-6, 1998M-2, 1998M-3, 1998M-2.5, 1998M-8, 1998M-9, 1998M-10, 1998M-12

Metric Hex L-Key Set with Nickel Finish - 15 Pcs



1998M/15T

Hex Size	Qty	Part No.
2, 2.5, 3, 4, 5, 6, 7, 8, 9, 10, 12, 14, 17, 19, 22 mm	15	1998M/15T

1998M-2, 1998M-5, 1998M-4, 1998M-7, 1998M-6, 1998M-3, 1998M-2.5, 1998M-14, 1998M-17, 1998M-19, 1998M-22, 1998M-8, 1998M-9, 1998M-10, 1998M-12

Metric Hex L-Key Set with Nickel Finish and Two-Component Compact Holder - 9 Pcs



BE-9878

Hex Size	Qty	Part No.
1.5, 2, 2.5, 3, 4, 5, 6, 8, 10 mm	9	BE-9878

1998M-1.5, 1998M-2.5, 1998M-2, 1998M-3, 1998M-4, 1998M-5, 1998M-6, 1998M-8, 1998M-10

Metric Hex L-Key Ring Set with Nickel Finish - 8 Pcs



1998M/8R

Hex Size	Qty	Part No.
2, 2.5, 3, 4, 5, 6, 7, 8 mm	8	1998M/8R

Metric Hex Folding L-Key Set with Zinc Finish - 7 Pcs



1999M/7H

Hex Size	Qty	Part No.
2.5, 3, 4, 5, 6, 8, 10 mm	7	1999M/7H

2.5, 3, 4, 5, 6, 8, 10

Imperial Long Ball End Hex L-Key Set with Nickel Finish - 12 Pcs



BE-9880

Hex Size	Length	Quantity	Part No.
0.050; 1/16; 5/64; 3/32; 7/64; 1/8; 9/64; 5/32; 3/16; 7/32; 1/4; 5/16 in	12	3	BE-9880

Metric Hex L-Keys with Phosphate Finish



1995M

Hex Size	Length	Quantity	Part No.
0.9 mm	33 mm	10	1995M-0.9
1.5 mm	47 mm	10	1995M-1.5
2.0 mm	52 mm	10	1995M-2
2.5 mm	59 mm	10	1995M-2.5
3.0 mm	66 mm	10	1995M-3
4.0 mm	74 mm	10	1995M-4
5.0 mm	85 mm	10	1995M-5
6.0 mm	96 mm	10	1995M-6
7.0 mm	102 mm	10	1995M-7
8.0 mm	108 mm	10	1995M-8
9.0 mm	114 mm	10	1995M-9
10 mm	122 mm	10	1995M-10
12 mm	137 mm	10	1995M-12
14 mm	154 mm	10	1995M-14
17 mm	177 mm	10	1995M-17
19 mm	199 mm	10	1995M-19
22 mm	222 mm	10	1995M-22

Imperial Hex L-Keys with Phosphate Finish



1995Z

Hex Size	Length	Quantity	Part No.
1/16 in	47 mm	10	1995Z-1/16
5/64 in	52 mm	10	1995Z-5/64
3/32 in	59 mm	10	1995Z-3/32

Hex Size	Length	Quantity	Part No.
1/8 in	66 mm	10	1995Z-1/8
5/32 in	74 mm	10	1995Z-5/32
3/16 in	85 mm	10	1995Z-3/16
7/32 in	91 mm	10	1995Z-7/32
1/4 in	96 mm	10	1995Z-1/4
5/16 in	108 mm	10	1995Z-5/16
3/8 in	122 mm	10	1995Z-3/8
7/16 in	129 mm	10	1995Z-7/16
1/2 in	145 mm	10	1995Z-1/2
5/8 in	168 mm	10	1995Z-5/8
3/4 in	199 mm	10	1995Z-3/4

Metric Hex L-Key Set with Phosphate Finish - 6 Pcs



1995M/

Hex Size	Length	Quantity	Part No.
2, 2.5, 3, 4, 5, 6 mm	6	1	1995M/6T

1995M-2, 1995M-2.5, 1995M-6, 1995M-5, 1995M-4, 1995M-3

Metric Hex L-Key Set with Phosphate Finish - 8 Pcs



1995M/8T

Hex Size	Length	Quantity	Part No.
2, 2.5, 3, 4, 5, 6, 7, 8 mm	8	1	1995M/8T

1995M-2.5, 1995M-2, 1995M-6, 1995M-5, 1995M-4, 1995M-3, 1995M-7, 1995M-8

Metric Hex L-Key Set with Phosphate Finish - 10 Pcs



1995M/10T

Hex Size	Length	Quantity	Part No.
2, 2.5, 3, 4, 5, 6, 7, 8, 9, 10 mm	10	1	1995M/10T

1995M-2.5, 1995M-2, 1995M-6, 1995M-5, 1995M-4, 1995M-3, 1995M-9, 1995M-10, 1995M-7, 1995M-8

Metric Hex L-Key Set with Phosphate Finish - 11 Pcs



1995M/11T

Hex Size	Length	Quantity	Part No.
2, 2.5, 3, 4, 5, 6, 7, 8, 9, 10, 12 mm	11	1	1995M/11T

1995M-2, 1995M-6, 1995M-5, 1995M-4, 1995M-2.5, 1995M-3, 1995M-9, 1995M-10, 1995M-7, 1995M-8, 1995M-12

Metric Hex L-Key Set with Phosphate Finish - 15 Pcs



1995M/15T

Hex Size	Length	Quantity	Part No.
2, 2.5, 3, 4, 5, 6, 7, 8, 9, 10, 12, 14, 17, 19, 22 mm	15	1	1995M/15T

1995M-2.5, 1995M-2, 1995M-6, 1995M-5, 1995M-4, 1995M-3, 1995M-9, 1995M-10, 1995M-7, 1995M-8, 1995M-17, 1995M-19, 1995M-12, 1995M-14, 1995M-22



Metric Hex L-Key Set with Phosphate Finish and Two-Component Holder - 9 Pcs



BE-9578

1.5, 2, 2.5, 3, 4, 5, 6, 8, 10 mm	9	1	BE-9578

1995M-2,5, 1995M-2, 1995M-1.5, 1995M-6, 1995M-5, 1995M-4, 1995M-3, 1995M-8, 1995M-10

Metric Hex Folding L-Key Set with Two-Component Handle 2.5 mm -10 mm - 7 Pcs



BE-9777B

2.5 3 4 5 6 8 10 mm	7	6	BE-9777B

2.5, 3, 4, 5, 6, 8, 10 mm

Metric Hex Folding L-Key Set 1.5 mm-6 mm - 7 Pcs



BE-9776

1.5 2 2.5 3 4 5 6 mm	6	BE-9776

1.5, 2, 2.5, 3, 4, 5, 6 mm

Metric Hex Folding L-Key Set 2.5 mm-10 mm - 7 Pcs



BE-9777

2.5 3 4 5 6 8 10 mm	7	6	BE-9777

2.5, 3, 4, 5, 6, 8, 10 mm

Imperial Hex L-Key Set with Phosphate Finish - 10 Pcs



1995Z/

1/16, 5/64, 3/32, 1/8, 5/32, 3/16, 7/32, 1/4, 5/16, 3/8 in	10	1	1995Z/10T

1995Z-1/16, 1995Z-5/64, 1995Z-3/32, 1995Z-1/8, 1995Z-5/32, 1995Z-3/16, 1995Z-3/8, 1995Z-7/32, 1995Z-1/4, 1995Z-5/16

Imperial Hex L-Key Set with Phosphate Finish - 12 Pcs



1995Z/12T

1/16, 5/64, 3/32, 1/8, 5/32, 3/16, 7/32, 1/4, 5/16, 3/8, 7/16, 1/2 in	12	1	1995Z/12T

1995Z-1/16, 1995Z-5/64, 1995Z-3/32, 1995Z-1/8, 1995Z-5/32, 1995Z-3/16, 1995Z-1/2, 1995Z-7/16, 1995Z-3/8, 1995Z-7/32, 1995Z-1/4, 1995Z-5/16

Imperial Hex Folding L-Key Set 3/32" - 3/8" - 7 Pcs



BE-9787

3/32 1/8 5/32 3/16 1/4 5/16 3/8 in	7	6	BE-9787

Metric Long Hex L-Keys with Phosphate Finish



1995LM

1.5 mm	91 mm	10	1995LM-1.5
2 mm	102 mm	10	1995LM-2
2.5 mm	114 mm	10	1995LM-2,5
3.0 mm	129 mm	10	1995LM-3
4.0 mm	144 mm	10	1995LM-4
5.0 mm	165 mm	10	1995LM-5
6.0 mm	186 mm	10	1995LM-6
7.0 mm	197 mm	10	1995LM-7
8.0 mm	208 mm	10	1995LM-8
9.0 mm	219 mm	10	1995LM-9
10 mm	234 mm	10	1995LM-10
12 mm	262 mm	10	1995LM-12
14 mm	294 mm	10	1995LM-14

Metric Long Hex L-Key Set with Phosphate Finish and Two-Component Holder - 6 Pcs



BE-9586

1.5, 2, 2.5, 3, 4, 5 mm	6	1	BE-9586

1995LM-1.5, 1995LM-3, 1995LM-2,5, 1995LM-2, 1995LM-4, 1995LM-5

Metric Long Hex L-Key Set with Phosphate Finish and Two-Component Holder - 9 Pcs



BE-9588

1.5, 2, 2.5, 3, 4, 5, 6, 8, 10 mm	9	1	BE-9588

1995LM-1.5, 1995LM-2, 1995LM-2.5, 1995LM-3, 1995LM-4, 1995LM-5, 1995LM-6, 1995LM-8, 1995LM-10

Metric Long Ball End Hex L-Keys with Phosphate Finish



1996M

1.5 mm	91 mm	10	1996M-1.5
2.0 mm	102 mm	10	1996M-2
2.5 mm	114 mm	10	1996M-2.5
3.0 mm	129 mm	10	1996M-3
4.0 mm	144 mm	10	1996M-4
5.0 mm	165 mm	10	1996M-5
6.0 mm	186 mm	10	1996M-6
8.0 mm	208 mm	10	1996M-8
10 mm	234 mm	10	1996M-10
12 mm	262 mm	5	1996M-12

Metric Long Ball End Coloured Hex L-Key Set - 9 Pcs



C1997LM/9P

1.5, 2, 2.5, 3, 4, 5, 6, 8, 10 mm	9	1	C1997LM/9P

Metric Long Ball End Hex L-Key Set with Phosphate Finish - 6 Pcs



BE-9765

1.5, 2, 2.5, 3, 4, 5 mm	6	3	BE-9765

1996M-1.5, 1996M-2.5, 1996M-2, 1996M-4, 1996M-3, 1996M-5

Metric Long Ball End Hex L-Key Set with Phosphate Finish - 9 Pcs



BE-9770

1.5, 2, 2.5, 3, 4, 5, 6, 8, 10 mm	9	3	BE-9770

1996M-1.5, 1996M-2.5, 1996M-2, 1996M-4, 1996M-3, 1996M-5, 1996M-6, 1996M-10, 1996M-8

Metric Long Ball End Hex L-Key Set with Phosphate Finish and Two-Component Holder - 9 Pcs



BE-9676

1.5, 2, 2.5, 3, 4, 5 mm	6	1	BE-9676

1996M-5, 1996M-4, 1996M-3, 1996M-2.5, 1996M-2, 1996M-1.5

Metric Long Ball End Hex L-Key Set with Phosphate Finish and Two-Component Holder - 9 Pcs



BE-9678

1.5, 2, 2.5, 3, 4, 5, 6, 8, 10 mm	9	1	BE-9678

1996M-4, 1996M-5, 1996M-2.5, 1996M-3, 1996M-10, 1996M-6, 1996M-8, 1996M-2, 1996M-1.5

Metric Long Ball End Hex L-Key Set with Phosphate Finish and Two-Component Magnetiser Holder - 9 Pcs



BE-9688

1.5, 2, 2.5, 3, 4, 5, 6, 8, 10 mm	9	1	BE-9688

1996M-1.5, 1996M-2, 1996M-2.5, 1996M-3, 1996M-4, 1996M-5, 1996M-6, 1996M-8, 1996M-10

Metric Ball End Hex Folding L-Key Set with Two-Component Handle 2.5 mm - 10 mm - 7 Pcs



BE-9776B

2.5, 3, 4, 5, 6, 8, 10 mm	7	6	BE-9776B



Imperial Long Ball End Hex L-Key Set with Phosphate Finish - 7 Pcs



BE-9775

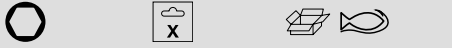

1/16, 5/64, 3/32, 1/8, 5/32, 3/16, 1/4 in 7 3 BE-9775

5/64 3/32 1/4 1/8 1/16 5/32 3/16

Imperial Long Ball End Hex L-Key Set with Phosphate Finish - 12 Pcs



BE-9780

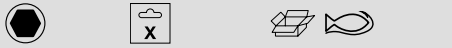

0.05 1/16 5/64 3/32 7/64 1/8 9/64 5/32 3/16 7/32 1/4 5/16 in 12 3 BE-9780

0.05 1/16 5/64 3/32 7/64 1/8 9/64 5/32 3/16 7/32 1/4 5/16

Imperial Long Ball End Hex L-Key Set with Phosphate Finish - 13 Pcs



BE-9785



0.05 1/16 5/64 3/32 7/64 1/8 9/64 5/32 3/16 7/32 1/4 5/16 3/8 in 13 3 BE-9785

0.05 1/16 5/64 3/32 7/64 1/8 9/64 5/32 3/16 7/32 1/4 5/16 3/8

TORX® TIPPED

Long TORX® L-Keys with Black Oxide Finish



1995TORX

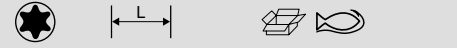

T 6	75 mm	5	1995TORX-T6
T 7	80 mm	5	1995TORX-T7
T 8	80 mm	5	1995TORX-T8
T 9	80 mm	5	1995TORX-T9
T 10	86 mm	5	1995TORX-T10
T 15	90 mm	5	1995TORX-T15
T 20	95 mm	5	1995TORX-T20
T 25	100 mm	5	1995TORX-T25
T 27	105 mm	5	1995TORX-T27
T 30	114 mm	5	1995TORX-T30
T 40	124 mm	5	1995TORX-T40
T 45	133 mm	5	1995TORX-T45
T 50	152 mm	5	1995TORX-T50
T 55	184 mm	5	1995TORX-T55
T 60	204 mm	5	1995TORX-T60

Long TORX® Coloured L-Key Set - 9 Pcs



C1997TORX/9P



8, 9, 10, 15, 20, 25, 27, 30, 40 9 1 C1997TORX/9P

Long TORX® L-Key Set with Black Oxide Finish - 4 Pcs



1995TORX/



10, 20, 30, 40 4 1 1995TORX/4T

1995TORX-T40, 1995TORX-T30, 1995TORX-T10, 1995TORX-T20



Long TORX® L-Key Set with Black Oxide Finish - 7 Pcs



1995TORX/7T

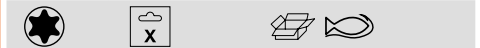

10, 15, 20, 25, 27, 30, 40 7 1 1995TORX/7T

1995TORX-T20, 1995TORX-T10, 1995TORX-T15, 1995TORX-T27, 1995TORX-T25, 1995TORX-T30, 1995TORX-T40



Long TORX® L-Key Set with Black Oxide Finish - 11 Pcs



1995TORX/11T



7, 9, 10, 15, 20, 25, 27, 30, 40, 45, 50 11 1 1995TORX/11T

1995TORX-T7, 1995TORX-T9, 1995TORX-T10, 1995TORX-T15, 1995TORX-T20, 1995TORX-T25, 1995TORX-T27, 1995TORX-T30, 1995TORX-T40, 1995TORX-T45, 1995TORX-T50



Long TORX® L-Key Set with Black Oxide Finish - 13 Pcs



1995TORX/13T

6, 7, 8, 9, 10, 15, 20, 25, 27, 30, 40, 45, 50	13	1	1995TORX/13T

1995TORX-T45, 1995TORX-T40, 1995TORX-T30, 1995TORX-T27, 1995TORX-T25, 1995TORX-T20, 1995TORX-T15, 1995TORX-T10, 1995TORX-T50, 1995TORX-T8, 1995TORX-T9, 1995TORX-T6, 1995TORX-T7

Long TORX® L-Key Set with Black Oxide Finish - 8 Pcs



BE-9575

T9, T10, T15, T20, T25, T27, T30, T40	8	1	BE-9575

1995TORX-T40, 1995TORX-T30, 1995TORX-T27, 1995TORX-T25, 1995TORX-T20, 1995TORX-T15, 1995TORX-T10, 1995TORX-T9

Long TORX® L-Key Set with Black Oxide Finish - 8 Pcs



BE-9585

T9, T10, T15, T20, T25, T27, T30, T40	8	1	BE-9585

1995TORX-T30, 1995TORX-T27, 1995TORX-T25, 1995TORX-T20, 1995TORX-T15, 1995TORX-T10, 1995TORX-T9, 1995TORX-T40

Folding TORX® L-Key Set with Two Component Handle T9 - T40 - 8 Pcs



BE-8975B

T 9 - T 10 - T 15 - T 20 - T 25 - T 27 - T 30 - T 40	8	6	BE-8975B

Folding TORX® L-Key Set T9 - T40 - 8 Pcs



BE-8975

T 9 10 15 20 25 27 30 40	8	6	BE-8975

Long Ball End TORX® L-Keys with Black Oxide Finish



1996TORX

T 9 T 10 T 15 T 20	80 mm 86 mm 90 mm 95 mm	5 5 5 5	1996TORX-T9 1996TORX-T10 1996TORX-T15 1996TORX-T20

T 25 T 27 T 30 T 40 T 45 T 50	100 mm 105 mm 114 mm 124 mm 133 mm 152 mm	5 5 5 5 5 5	1996TORX-T25 1996TORX-T27 1996TORX-T30 1996TORX-T40 1996TORX-T45 1996TORX-T50

Long Ball End TORX® L-Key Set with Black Oxide Finish - 5 Pcs



1996TORX/

T10, T20, T25, T30, T40	5	1	1996TORX/5T

1996TORX-T10, 1996TORX-T20, 1996TORX-T25, 1996TORX-T30, 1996TORX-T40

Long Ball End TORX® L-Key Set with Black Oxide Finish - 8 Pcs



BE-9675

T9, T10, T15, T20, T25, T27, T30, T40	8	1	BE-9675

1996TORX-T10, 1996TORX-T9, 1996TORX-T15, 1996TORX-T20, 1996TORX-T25, 1996TORX-T27, 1996TORX-T30, 1996TORX-T40



Long Tamper-Resistant TORX® L-Keys with Black Oxide Finish



1986TORX

Part No.	Length (mm)	Quantity	Accessories
TR 9	80 mm	5	1986TORX-T9
TR 10	86 mm	5	1986TORX-T10
TR 15	90 mm	5	1986TORX-T15
TR 20	95 mm	5	1986TORX-T20
TR 25	100 mm	5	1986TORX-T25
TR 27	105 mm	5	1986TORX-T27
TR 30	114 mm	5	1986TORX-T30
TR 40	124 mm	5	1986TORX-T40

Long Tamper-Resistant TORX® L-Key Set with Black Oxide Finish - 7 Pcs



1986TORX/

Part No.	Quantity	Accessories
TR10, TR15, TR20, TR25, TR27, TR30, TR40	7	1 1986TORX/7T

1986TORX-T10, 1986TORX-T15, 1986TORX-T20, 1986TORX-T25, 1986TORX-T27, 1986TORX-T30, 1986TORX-T40

Long Tamper-Resistant TORX® L-Key Set with Black Oxide Finish - 8 Pcs



BE-8675

Part No.	Quantity	Accessories
T9, T10, T15, T20, T25, T27, T30, T40	8	1 BE-8675

1986TORX-T10, 1986TORX-T9, 1986TORX-T20, 1986TORX-T15, 1986TORX-T30, 1986TORX-T40, 1986TORX-T25, 1986TORX-T27

Folding TORX® Tamper L-Key Set with Two Component Handle T9 - T40 - 8 Pcs



BE-8976B

Part No.	Quantity	Accessories
T9, T10, T15, T20, T25, T27, T30, T40	8	6 BE-8976B

Long TORX® Plus L-Keys with Black Oxide Finish



1976TORX

Part No.	Length (mm)	Quantity	Accessories
IP 6	75 mm	5	1976TORX-T6
IP 7	80 mm	5	1976TORX-T7
IP 8	80 mm	5	1976TORX-T8
IP 9	80 mm	5	1976TORX-T9
IP 10	86 mm	5	1976TORX-T10
IP 15	90 mm	5	1976TORX-T15
IP 20	95 mm	5	1976TORX-T20
IP 25	100 mm	5	1976TORX-T25
IP 27	105 mm	5	1976TORX-T27
IP 30	114 mm	5	1976TORX-T30
IP 40	124 mm	5	1976TORX-T40

Long TORX® Plus L-Key Set with Black Oxide Finish - 5 Pcs



1976TORX/

Part No.	Quantity	Accessories
IP 10, IP 20, IP 25, IP 30, IP 40	5	1 1976TORX/5T

1976TORX-T10, 1976TORX-T20, 1976TORX-T25, 1976TORX-T40, 1976TORX-T30

Long TORX® Plus L-Key Set with Black Oxide Finish - 8 Pcs



BE-7675

Part No.	Quantity	Accessories
IP9, IP10, IP15, IP20, IP25, IP27, IP30, IP40	8	1 BE-7675

1976TORX-T10, 1976TORX-T9, 1976TORX-T15, 1976TORX-T20, 1976TORX-T25, 1976TORX-T30, 1976TORX-T40, 1976TORX-T27

DOUBLE OFFSET

Double Offset Slotted L-Keys



2047

Width	Length	Quantity	Part Number
4.0 mm	100 mm	5	2047-0.8-4
5.5 mm	125 mm	5	2047-1-5.5
8.0 mm	150 mm	5	2047-1.2-8
10.0 mm	175 mm	1	2047-1.6-10
12.0 mm	200 mm	1	2047-2-12

Double Offset Pozidriv L-Keys



2047PZ

Size	Length	Quantity	Part Number
PZ1, PZ2	100 mm	5	2047PZ-1-2

MULTITOOLS

Mixed Bicycle Folding Tool Set with Pouch



Double Offset Phillips L-Keys



2047PR

Size	Length	Quantity	Part Number
PH 1 & 2	100 mm	5	2047PR-1-2
PH 3 & 4	200 mm	5	2047PR-3-4



BKE850901N

200 x 35 x 170 mm	10	BKE850901N
-------------------	----	------------





BAHCO



Pliers



CUTTING PLIERS

ERGO™ Side Cutting Pliers with Self Opening Dual-Component Handle and Phosphate Finish



ergo



2101G

Cu	Fe+	Plato		
3.5 mm	1.8 mm	1.6 mm	5	2101G-125
3.7 mm	2.0 mm	1.8 mm	5	2101G-140
3.8 mm	2.5 mm	2.0 mm	5	2101G-160
4.0 mm	2.7 mm	2.3 mm	5	2101G-180
3.5 mm	1.8 mm	1.6 mm	5	2101G-125IP
3.7 mm	2.0 mm	1.8 mm	5	2101G-140IP
3.8 mm	2.5 mm	2.0 mm	5	2101G-160IP
4.0 mm	2.7 mm	2.3 mm	5	2101G-180IP

ERGO™ Side Cutting Pliers with Dual-Component Handle and Phosphate Finish



ergo



2101G_D

Cu	Fe+	Plato		
3.5 mm	1.8 mm	1.6 mm	5	2101G-125IPD
3.7 mm	2.0 mm	1.8 mm	5	2101G-140IPD
3.8 mm	2.5 mm	2.0 mm	5	2101G-160IPD
4.0 mm	2.7 mm	2.3 mm	5	2101G-180IPD

ERGO™ Side Cutting Pliers with Self Opening Dual-Component Handle and Phosphate Finish for Plastic



ergo



2101PG

L		
160 mm	5	2101PG-160

BAHCO

ERGO™ Side Cutting Pliers with Self Opening Dual-Component Handle and Nickel-Chrome Finish



ergo



2101GC

Cu	Fe+	Plato		
3.5 mm	1.8 mm	1.6 mm	5	2101GC-125IP
3.7 mm	2.0 mm	1.8 mm	5	2101GC-140IP
3.8 mm	2.5 mm	2.0 mm	5	2101GC-160IP
4.0 mm	2.7 mm	2.3 mm	5	2101GC-180IP

Side Cutting Pliers with Mono Material Handles and Phosphate Finish



2101D

Cu	Fe+	Plato		
3.5 mm	1.8 mm	1.6 mm	5	2101D-125
3.7 mm	2.0 mm	1.8 mm	5	2101D-140
3.8 mm	2.5 mm	2.0 mm	5	2101D-160
4.0 mm	2.7 mm	2.3 mm	5	2101D-180
3.5 mm	1.8 mm	1.6 mm	5	2101D-125IP
3.7 mm	2.0 mm	1.8 mm	5	2101D-140IP
3.8 mm	2.5 mm	2.0 mm	5	2101D-160IP
4.0 mm	2.7 mm	2.3 mm	5	2101D-180IP

ERGO™ Heavy Duty Side Cutting Pliers with Self Opening Dual-Component Handle and Phosphate Finish



ergo



21HDG

Fe+	Plato	L		
2.3 mm	2.1 mm	140 mm	5	21HDG-140
2.7 mm	2.3 mm	160 mm	5	21HDG-160
3.3 mm	2.8 mm	180 mm	5	21HDG-180
3.3 mm	2.8 mm	200 mm	5	21HDG-200
2.3 mm	2.1 mm	140 mm	5	21HDG-140IP
2.7 mm	2.3 mm	160 mm	5	21HDG-160IP
3.3 mm	2.8 mm	180 mm	5	21HDG-180IP
3.3 mm	2.8 mm	200 mm	5	21HDG-200IP

ERGO™ 14° Side Cutting Pliers with Self Opening Dual-Component Handle and Phosphate Finish



21HDG-A

Fe	Plano	L		
2.2 mm	2.0 mm	140 mm	5	21HDG-140A
2.5 mm	2.3 mm	160 mm	5	21HDG-160A
2.7 mm	2.5 mm	180 mm	5	21HDG-180A
3.2 mm	3.0 mm	200 mm	5	21HDG-200A

ERGO™ Heavy Duty Side Cutting Pliers with Self Opening Dual-Component Handle and Chrome Finish



21HDGC

Fe	Plano	L		
2.2 mm	2.2 mm	140 mm	5	21HDGC-140IP
2.5 mm	2.5 mm	160 mm	5	21HDGC-160IP
2.8 mm	2.8 mm	180 mm	5	21HDGC-180IP
3.2 mm	3.0 mm	200 mm	5	21HDGC-200IP

Heavy Duty Side Cutting Pliers with Mono Material Handles and Phosphate Finish



21HDD

Fe	Plano	L		
2.2 mm	2.2 mm	140 mm	5	21HDD-140
2.5 mm	2.5 mm	160 mm	5	21HDD-160
2.8 mm	2.8 mm	180 mm	5	21HDD-180
3.2 mm	3.0 mm	200 mm	5	21HDD-200
2.2 mm	2.2 mm	140 mm	5	21HDD-140IP
2.5 mm	2.5 mm	160 mm	5	21HDD-160IP
2.8 mm	2.8 mm	180 mm	5	21HDD-180IP
3.2 mm	3.0 mm	200 mm	5	21HDD-200IP

Power Cutters with Dual-Component Handle and Phosphate Finish



1520G

Fe	L		
3.8 mm	210 mm	5	1520 G
3.8 mm	210 mm	5	1520 G IP

Power Cutters with PVC Coated Handles and Phosphate Finish



1520D

Fe	L		
3.8 mm	205 mm	5	1520 D

ERGO™ Compact Side Cutting Pliers with Dual-Component Handle and Phosphate Finish



4130, 4131



Fe	L		
0.3-1.5 mm	120 mm	3	4130
0.3-1.5 mm	120 mm	3	4131



Compact Oval Head Side Cutters with Orange PVC Handle





C3140

			
0,4-2,0 mm	130 mm	10	C3140
0,4-2,0 mm	130 mm	10	C3140IP

Side Cutting Pliers with PVC Coated Handles and Phosphate Finish



2100PD



				
1.8 mm	3.0 mm	150 mm	5	2100PD-150

PLASTIC

Compact Side Cutting Pliers with Orange PVC Handle







C3330

			
0,3-1,6 mm	115 mm	10	C3330
0,3-1,6 mm	115 mm	10	C3330IP

Side Cutting Pliers with Dual-Component Handle and Polished Finish





2171G

				
2.5 mm	1.6 mm	1.5 mm	5	2171G-140
2.5 mm	1.6 mm	1.5 mm	5	2171G-160
2.5 mm	1.6 mm	1.5 mm	5	2171G-180

Compact Tapered and Relieved Head Side Cutters with Orange PVC Handle



C3330R/C3340R

			
0,3-1,25 mm	115 mm	10	C3330R
0,3-1,25 mm	115 mm	10	C3330R IP
0,4-1,6 mm	130 mm	10	C3340R
0,4-1,6 mm	130 mm	10	C3340R IP

Side Cutting Pliers with Cellulose Acetate Handles and Nickel-Chrome Finish For Steel Wire



2666NB-2676NB

				
2.7 mm	2.0 mm	160 mm	1	2674 NB

Side Cutting Pliers with Cellulose Acetate Handles and Nickel-Chrome Finish For Piano wire



2667B-2678B

3.7 mm	2.0 mm	2.0 mm	1	2676 B
4.0 mm	2.5 mm	2.5 mm	1	2678 B

0.1-1.0 mm	Ultra-flush	110 mm	1	2646 AK
0.2-1.25 mm	Ultra-flush	112.5 mm	1	2666 FK
0.4-2.0 mm	Micro-bevel	125 mm	1	2648
0.3-1.6 mm	Ultra-flush	125 mm	1	2648 A

Diagonal Cutters with Oval Head



2646M - 2649

0.1-0.8 mm	Flush	108 mm	1	2646 M
0.2-1.25 mm	Micro-bevel	110 mm	1	2646 R
0.2-1.25 mm	Micro-bevel	110 mm	1	2646 RK
0.1-1.0 mm	Flush	110 mm	1	2646 RA
0.3-1.6 mm	Micro-bevel	112.5 mm	1	2666
0.4-2.0 mm	Micro-bevel	125 mm	1	2649

ERGO™ 20° Oblique Cutters



4231

0.3-1.25 mm	119 mm	3	4231

Diagonal Cutters with Tapered Head



2646 - 2648A

0.2-1.25 mm	Micro-bevel	110 mm	1	2646
0.2-1.25 mm	Micro-bevel	110 mm	1	2646 K
0.1-1.0 mm	Ultra-flush	110 mm	1	2646 A

ERGO™ 45° Oblique Cutters



4239

0.3-1.0 mm	129 mm	3	4239



45° Oblique Cutters with PVC Coated Handles and Phosphate Finish



2145PD

PLASTIC

3.0 mm	1.8 mm	154 mm	5	2145PD-150

End Cutting Pliers with Bi-Material Handles and Chrome Finish



527 GC

2.0 mm 2.5 mm	160 mm 200 mm	3 3	527 GC-160 527 GC-200

45° Oblique Cutters with Long Head



2787F

0.2-1.0 mm	Flush	117.5 mm	1	2787 F

End Cutting Pliers with PVC Handles and Phosphate Finish



527D

2 mm 2.5 mm	160 mm 200 mm	5 5	527 D-160 527 D-200

45° Oblique Cutters with Relieved Long Head



2787G

0.2-0.8 mm	Flush	117.5 mm	1	2787 G

High Leverage End Cutting/Fencing Pliers with PVC Coated Handles and Black Epoxy Finish





2339D

2.2 mm 2.2 mm 4.5 mm 4.5 mm	220 mm 220 mm 300 mm 300 mm	3 5 5 6	2339 D 2339 DIP 2339D-300 2339D-300IP

High Leverage End Cutting/Fencing Pliers with Black Epoxy Finish



2339

		
2.2 mm	220 mm	5 2339-220
2.2 mm	220 mm	5 2339-220IP
2.5 mm	250 mm	5 2339-250IP
3.0 mm	280 mm	5 2339-280IP
4.5 mm	300 mm	6 2339-300IP

Compact End Cutting Pliers with Orange PVC Handle





C3230

	
109 mm	10 C3230
109 mm	10 C3230IP

Pincers with PVC Handles and Black Epoxy Finish



541D

		
2.0 mm	150 mm	5 541 D-150
2.0 mm	180 mm	5 541D-180
2.5 mm	200 mm	5 541 D-200
2.5 mm	225 mm	5 541D-225
2.5 mm	250 mm	5 541 D-250

90° Side Cutting Pliers with PVC Coated Handles and Phosphate Finish



2190PD



			
1.8 mm	3.0 mm	143 mm	5 2190PD-150

PLASTIC

High Leverage End Cutting/Fencing Pliers with Phosphate Finish



1519D

		
2.5 mm	230 mm	3 1519 D
		1 1519-9

End Cutters with Synthetic Handles and Mirror Finish



2656/2656A

			
0.35 - 0.8 mm	Micro	115 mm	1 2656



Cable Cutting/Stripping Pliers with PVC Coated Handles for Cu and Al Cables



2233D

Icon	Icon	Icon	Icon	Icon
10 mm	50/35 mm	160 mm	5	2233 D-160
13 mm	70/50 mm	200 mm	5	2233 D-200
16 mm	95/70 mm	240 mm	5	2233 D-240
10 mm	50/35 mm	160 mm	5	2233D-160IP
13 mm	70/50 mm	200 mm	5	2233D-200IP
16 mm	95/70 mm	240 mm	5	2233D-240IP

Cable Cutters with Epoxy Painted Handles for Cu, Al and Steel Cables



2720

Icon	Icon	Icon	Icon
42 mm	600 mm 163 mm	1	2720 2720-SH

Cable Cutters with Epoxy Painted Handles for Cu and Al Cables 30 mm



2520

Icon	Icon	Icon
550 mm	1	2520

Cable Cutters with Elastomer Handles for Solid Materials and Multi Wire Cables



2235-160

Icon	Icon	Icon
165 mm	1	2235-160

Cable Cutters with Epoxy Painted Handles for Cu and Al Cables 42 mm



2620-80

Icon	Icon	Icon	Icon
42 mm	800 mm	1	2620-80

Cable Cutters with PVC Coated Handles for Cu and Al Cables



2804-2805

Icon	Icon	Icon	Icon	Icon
16 mm 22 mm	34 mm 52 mm	250 mm 280 mm	1	2804 2805-280

Cable Cutters with PVC Coated Handles for Multi Wire and Flexible Conductors



2800N-2801N

Icon	Icon	Icon	Icon
0-10 mm	170 mm	1	2800 N
0-15 mm	230 mm	1	2801 N

Diagonal Bolt Cutters with Phosphate Finish



4560-210

Icon	Icon	Icon	Icon
250 mm		1	4560-210

Bolt Cutters with Comfort Grip Handles and Phosphate Finish



4559

Icon	Icon	Icon	Icon	Icon
6 mm	5 mm	4 mm	1	4559-12
8 mm	7 mm	6 mm	8	4559-18
10 mm	9 mm	8 mm	6	4559-24
13 mm	10 mm	9 mm	5	4559-30
15 mm	12 mm	11 mm	3	4559-36
15 mm	12 mm	11 mm	2	4559-42

COMBINATION PLIERS

ERGO™ Combination Pliers with Self-Opening Dual-Component Handles and Phosphate Finish



2628G

Icon	Icon	Icon	Icon	Icon
1.8 mm	2.0 mm	160 mm	5	2628 G-160
2.0 mm	2.5 mm	180 mm	5	2628 G-180
2.5 mm	3.0 mm	200 mm	5	2628 G-200
1.8 mm	2.0 mm	160 mm	5	2628 G-160IP
2.0 mm	2.5 mm	180 mm	5	2628 G-180IP
2.5 mm	3.0 mm	200 mm	5	2628G-200IP

Spare Cutting Heads for 4559 Range Bolt Cutters



4559 JC

Icon	Icon	Icon
285 g	1	4559-12A JC
600 g	1	4559-18B JC
930 g	1	4559-24B JC
1260 g	1	4559-30B JC
2180 g	1	4559-36B JC
3025 g	1	4559-42A JC

ERGO™ Combination Pliers with Self-Opening Dual-Component Handles and Chrome Finish



2628GC

Icon	Icon	Icon	Icon	Icon
2.0 mm	1.8 mm	160 mm	5	2628 GC-160IP
2.5 mm	2.0 mm	180 mm	5	2628 GC-180IP
3.0 mm	2.5 mm	200 mm	5	2628 GC-200IP



ERGO™ Reinforced Combination Pliers with Self-Opening Dual-Component Handles and Chrome Finish



ergo



2630GC

Plano	Fe+	L		
1.8 mm	2.0 mm	160 mm	5	2630GC-160IP
2.0 mm	2.5 mm	180 mm	5	2630GC-180IP
2.5 mm	3.0 mm	200 mm	5	2630GC-200IP

Reinforced Combination Pliers with Monomaterial Handles and Chrome Finish



2630DC

Fe+	Plano	L		
2.0 mm	1.8 mm	160 mm	5	2630DC-160IP
2.5 mm	2.0 mm	180 mm	5	2630DC-180IP
3.0 mm	2.5 mm	200 mm	5	2630DC-200IP

ERGO™ Combi-Snipe Pliers with Self-Opening Dual-Component Handles and Phosphate Finish



ergo



2629G

L	Fe+	Plano		
160 mm	2.0 mm	1.8 mm	5	2629G-160
180 mm	3.0 mm	2.5 mm	5	2629G-180
200 mm	2.5 mm	2.0 mm	5	2629G-200
160 mm	2.5 mm	2.0 mm	5	2629G-160IP
180 mm	2.0 mm	1.8 mm	5	2629G-180IP
200 mm	3.0 mm	2.5 mm	5	2629G-200IP

Universal Combination Pliers with PVC Coated Handles



2640D

Cu	Fe	Fe+		
3.0 mm	2.7 mm	2.5 mm	10	2640D-160
3.0 mm	2.7 mm	2.5 mm	5	2640D-180
3.5 mm	3.0 mm	2.5 mm	5	2640D-200

Combination Pliers with Monomaterial Handles and Phosphate Finish



2628D

Fe+	Plano	L		
2.0 mm	1.8 mm	160 mm	5	2628 D-160
2.5 mm	2.0 mm	180 mm	5	2628 D-180
3.0 mm	2.5 mm	200 mm	5	2628 D-200

High Leverage Universal Combination Pliers with PVC Coated Handles



2688D

Fe+	Fe	Cu		
2.5 mm	3.0 mm	3.5 mm	3	2688D-250

Combination Pliers with Dual-Component Handles



2678G

1.7 mm	1.3 mm	160 mm	5	2678 G-160
2.0 mm	1.4 mm	180 mm	5	2678 G-180
2.5 mm	1.5 mm	205 mm	5	2678 G-200

2 Position Combination Pliers with Lacquered Finish



2970 G-200

200 mm	5	2970G-200

GRIPPING PLIERS

ERGO™ Long Snipe Nose Pliers with Self-Opening Dual-Component Handles and Phosphate Finish



2430G

2.5 mm	1.8 mm	1.4 mm	5	2430 G-140
3.0 mm	1.8 mm	1.6 mm	5	2430 G-160
3.0 mm	1.8 mm	1.6 mm	5	2430 G-200
2.5 mm	1.8 mm	1.4 mm	5	2430 G-140 IP
3.0 mm	1.8 mm	1.6 mm	5	2430 G-160 IP
3.0 mm	1.8 mm	1.6 mm	5	2430 G-200 IP

ERGO™ Long Snipe Nose Pliers with Self-Opening Dual-Component Handles and Chrome Finish



2430GC

2.5 mm	1.8 mm	1.4 mm	5	2430 GC-140 IP
3.0 mm	1.8 mm	1.6 mm	5	2430 GC-160 IP
3.0 mm	1.8 mm	1.6 mm	5	2430 GC-200 IP

Long Snipe Nose Pliers with Monomaterial Handles and Phosphate Finish



2430D

2.5 mm	1.8 mm	1.4 mm	5	2430 D-140
3.0 mm	1.8 mm	1.6 mm	5	2430 D-160
3.0 mm	1.8 mm	1.6 mm	5	2430 D-200
2.5 mm	1.8 mm	1.4 mm	5	2430 D-140 IP
3.0 mm	1.8 mm	1.6 mm	5	2430 D-160 IP
3.0 mm	1.8 mm	1.6 mm	5	2430 D-200 IP

ERGO™ Long Snipe Nose Pliers without Cutting Edge, with Self-Opening Dual-Component Handles and Phosphate Finish



2431G

125 mm	5	2431G-125
140 mm	5	2431G-140
160 mm	5	2431G-160
180 mm	5	2431G-180
125 mm	5	2431G-125IP
140 mm	5	2431G-140IP
160 mm	5	2431G-160IP
180 mm	5	2431G-180IP



ERGO™ Compact Snipe Nose Pliers with Dual-Component Handles and Phosphate Finish



ergo



4830, 4831



135 mm
135 mm



3 4830
3 4831

Snipe Nose Pliers with Synthetic Handles and Mirror Polish Finish



2656S



132 mm



1 2656 S



Compact Snipe Nose Pliers with Orange PVC Handle



C3830/C3840



121 mm
121 mm
144 mm
144 mm



10 C3830
10 C3830IP
10 C3840
10 C3840IP

Snipe Nose Pliers with Dual-Component Handles and Lacquered Finish



2470G



3.0 mm
3.0 mm



1.5 mm
1.5 mm



1.0 mm
1.0 mm



5 2470 G-160
5 2470 G-200

Compact Snipe Needle Nose Pliers with Orange PVC Handle



C3630/C3640



130 mm
130 mm
145 mm
145 mm

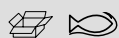

10 C3630
10 C3630IP
10 C3640
10 C3640IP

Extra Long Snipe Nose Pliers with PVC Coated Handles and Fine Polish Finish



158-N



280 mm



12 158-N

ERGO™ 45° Bent Tip Snipe Nose Pliers with Self-Opening Dual-Component Handles and Phosphate Finish



ergo®



2427G

3.0 mm	1.8 mm	1.6 mm	5	2427 G-160
3.0 mm	1.8 mm	1.6 mm	5	2427 G-200
3.0 mm	1.8 mm	1.6 mm	5	2427 G-160 IP
3.0 mm	1.8 mm	1.6 mm	5	2427 G-200 IP

ERGO™ 60° Bent Tip Snipe Nose Pliers with Dual-Component Handles and Phosphate Finish



ergo®



4833

130 mm	3	4833

ERGO™ 45° Bent Tip Snipe Nose Pliers with Self-Opening Dual-Component Handles and Chrome Finish



ergo®



2427GC

3.0 mm	1.8 mm	1.6 mm	5	2427 GC-160IP
3.0 mm	1.8 mm	1.6 mm	5	2427 GC-200IP

Compact Needle Snipe Nose Pliers with 45° Bent Tip and Orange PVC Handle



C3745

141 mm	10	C3745
141 mm	10	C3745IP

45° Bent Tip Snipe Nose Pliers with Monomaterial Handles and Phosphate Finish



2427D

3.0 mm	1.8 mm	1.6 mm	5	2427 D-160
3.0 mm	1.8 mm	1.6 mm	5	2427 D-200

Compact 90° Bent Tip Snipe Nose Pliers with Orange PVC Handle



C3790

125 mm	10	C3790
125 mm	10	C3790IP



60° Bent Tip Snipe Nose Pliers with Synthetic Handles and Mirror Polished Finish



2656R

129 mm	1	2656 R

45° Bent Tip Snipe Nose Pliers with Dual-Component Handles and Lacquered Finish



2477G-200

3.0 mm	1.5 mm	1 mm	5	2477G-160
3.0 mm	1.5 mm	1 mm	5	2477 G-200

35° Bent Tip Extra Long Snipe Nose Pliers with PVC Coated Handles and Fine Polished Finish



158-NB

270 mm	12	158-NB

ERGO™ Short Flat Nose Pliers with Self-Opening Dual-Component Handles and Phosphate Finish



2420G

125 mm	5	2420 G-125
125 mm	5	2420G-125IP

ERGO™ Long Flat Nose Pliers with Self-Opening Dual-Component Handles and Phosphate Finish



2421G

140 mm	5	2421 G-140
160 mm	5	2421 G-160
180 mm	5	2421 G-180
140 mm	5	2421 G-140IP
160 mm	5	2421 G-160 IP
180 mm	5	2421 G-180 IP

ERGO™ Long Flat Nose Pliers with Self-Opening Dual-Component Handles and Chrome Finish



2421GC

140 mm	5	2421GC-140IP
160 mm	5	2421GC-160IP
180 mm	5	2421GC-180IP

Long Flat Nose Pliers with Monomaterial Handles and Phosphate Finish



2421D

140 mm	5 2421 D-140IP
160 mm	5 2421 D-160IP
180 mm	5 2421 D-180IP

Compact Flat Nose Pliers with Orange PVC Handle



C3430

129 mm	10 C3430
129 mm	10 C3430IP

ERGO™ Connector Pliers with Self-Opening Dual-Component Handles and Phosphate Finish



7835G

3.0 mm	5 7835 G-160
1.8 mm	
1.6 mm	

Flat Nose Pliers with Synthetic Handles and Mirror Polish Finish



2646MF

120 mm	1 2646 MF

ERGO™ Flat Nose Pliers with Dual-Component Handles and Phosphate Finish



4430

135 mm	3 4430

Long Flat Nose Pliers with Dual-Component Handles and Lacquered Finish



2471G

165 mm	5 2471 G-160



Flat Nose Nut Pliers with PVC Coated Handles and Phosphate Finish



2979D



180 mm



5 2979 D-180

ERGO™ Compact Round Nose Pliers with Dual-Component Handles and Phosphate Finish



4530



135 mm



3 4530

ERGO™ Round Nose Pliers with Self-Opening Dual-Component Handles and Phosphate Finish



2521G



140 mm
160 mm
140 mm
160 mm



5 2521 G-140
5 2521G-160
5 2521G-140IP
5 2521 G-160 IP

Compact Round Nose Pliers with Orange PVC Handle



C3530



127 mm
127 mm

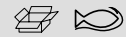

10 C3530
10 C3530IP

Round Nose Pliers with Monomaterial Handles and Phosphate Finish



2521D



140 mm
160 mm



5 2521D-140IP
5 2521D-160IP

Chain Nose Pliers with Synthetic Handle



2646MS



120 mm



1 2646 MS

WATERPUMP PLIERS

ERGO™ Slip Joint Water Pump Pliers with Dual-Component Handles and Phosphate Finish



8223 - 8226



max	L		
210 mm		4	8223
250 mm		4	8224
315 mm		4	8225
400 mm		1	8226
210 mm		4	8223 IP
250 mm		4	8224 IP
315 mm		4	8225 IP

ERGO™ Slip Joint Water Pump Pliers with Dual-Component Handles and Chrome Finish



8224/8225C



L			
250 mm		4	8224CIP
315 mm		4	8225CIP

ERGO™ Extra Wide Jaw Slip Joint Water Pump Pliers with Dual-Component Handles and Phosphate finish



8231



max	L		
51 mm	225 mm	4	8231
51 mm	225 mm	4	8231 IP

Quick Adjust Slip Joint Water Pump Pliers with Phosphate Finish



7223-7225

max	L		
45 mm	200 mm	4	7223
63 mm	250 mm	4	7224
70 mm	300 mm	8	7225
45 mm	200 mm	8	7223IP
63 mm	250 mm	4	7224IP
70 mm	300 mm	4	7225IP

Quick-Adjust Water Pump Pliers with PVC Handle



7223D 7225D

	L		
16	200 mm	8	7223D
25	300 mm	4	7225D
16	200 mm	8	7223D IP
25	300 mm	4	7225D IP

Box Joint Water Pump Pliers with Dual-Component Handle



6224

	L		
11	250 mm	4	6224



Box Joint Water Pump Pliers with PVC Handle



6221D-6225D

6	125 mm	10	6221D
8	150 mm	10	6222D
10	200 mm	8	6223D
11	250 mm	5	6224D
13	300 mm	10	6225D
6	125 mm	10	6221D IP
8	150 mm	10	6222D IP
10	200 mm	8	6223D IP
11	250 mm	5	6224D IP
13	300 mm	5	6225D IP

Box Joint Water Pump Pliers with Dual-Component Handles and Phosphate Finish



2971G

35 mm	250 mm	5	2971G-250

Screw Joint Water Pump Pliers with PVC Coated Handles and Phosphate Finish



221 D - 225 D

117 mm	5	221 D
150 mm	5	222 D
192 mm	5	223 D
240 mm	5	224 D
305 mm	5	225 D

Screw Joint Water Pump Pliers with PVC Coated Handles and Chrome Finish



5223 - 5226 DC

105 mm	400 mm	1	5226 DC

Connector Pliers with PVC Coated Handles and Chrome Finish



2650

65 mm	235 mm	1	2650
	235 mm	1	2650 B

Box Joint Water Pump Pliers Set - 3 Pcs



622-3P

110 x 50 x 390 mm	3	1260 g	1	622-3P

6223D, 6224D, 6225D



Water Pump Pliers Set - 3 Pcs



7224-622XD-3P

75 x 50 x 260 mm	3	813 g	1	7224-622XD-3P

6221D, 6224D

7224



CIRCLIP PLIERS

Internal Circlip Pliers with Straight Jaws and Phosphate Finish



2800

8-13 mm	0.8 mm	140 mm	3	2800-140
12-25 mm	1.2 mm	150 mm	3	2800-150
19-60 mm	1.7 mm	180 mm	3	2800-180
40-100 mm	2.2 mm	225 mm	3	2800-225
85-165 mm	3.1 mm	310 mm	1	2800-300

Internal Circlip Pliers with 90° Offset Jaws and Phosphate Finish



2890

8-15 mm	0.8 mm	127 mm	3	2890-125
12-25 mm	1.2 mm	127 mm	3	2890-140
19-60 mm	1.7 mm	180 mm	3	2890-180

40-100 mm	2.2 mm	210 mm	3	2890-210
85-165 mm	3.1 mm	300 mm	1	2890-300

Internal Circlip Pliers with Straight Jaws and Chrome Finish



2461

8-25 mm	1.0-2.0 mm	140 mm	1	2461 C8
19-60 mm	2.0-2.5 mm	180 mm	1	2461 C19
40-100 mm	2.5-3.5 mm	255 mm	1	2461 C40

Internal Circlip Pliers with 90° Offset Jaws and Chrome Finish



2463

8-25 mm	1.0-2.0 mm	130 mm	1	2463 D8
19-60 mm	2.0-2.5 mm	170 mm	1	2463 D19
40-100 mm	2.5-3.5 mm	210 mm	1	2463 D40



External Circlip Pliers with Straight Jaws and Phosphate Finish



2900

⌀	+	L	⊠	⊡
3-10 mm	0.8 mm	140 mm	3	2900-140
10-25 mm	1.2 mm	150 mm	3	2900-150
19-60 mm	1.7 mm	180 mm	3	2900-180
40-100 mm	2.2 mm	215 mm	3	2900-215
85-165 mm	3.1 mm	300 mm	1	2900-300

External Circlip Pliers with 90° Offset Jaws and Phosphate Finish



2990

⌀	+	L	⊠	⊡
3-10 mm	0.8 mm	12 mm	3	2990-125
10-25 mm	1.2 mm	127 mm	3	2990-140
19-60 mm	1.7 mm	180 mm	3	2990-180
40-100 mm	2.2 mm	200 mm	3	2990-200
85-165 mm	3.1 mm	300 mm	1	2990-300

External Circlip Pliers with Straight Jaws and Chrome Finish



2464

⌀	+	L	⊠	⊡
3-10 mm	1.0-1.5 mm	120 mm	1	2464 A3
10-25 mm	1.5-2.0 mm	120 mm	1	2464 A10
19-60 mm	2.0-2.5 mm	180 mm	1	2464 A19
40-100 mm	2.5-3.0 mm	210 mm	1	2464 A40

External Circlip Pliers with 90° Offset Jaws and Chrome Finish



2466

⌀	+	L	⊠	⊡
3-10 mm	1.0-1.5 mm	130 mm	1	2466 B3
10-25 mm	1.5-2.0 mm	130 mm	1	2466 B10
19-60 mm	2.0-2.5 mm	165 mm	1	2466 B19
40-100 mm	2.5-3.0 mm	190 mm	1	2466 B40

Internal and External Circlips Resettable Pliers



2928

⌀	⌀	L	⊠	⊡
7-26 mm	3-26 mm	160 mm	1	2928-160
10-51 mm	7-51 mm	200 mm	1	2928-200
46-102 mm	38-102 mm	250 mm	1	2928-250

Spare Tips for 2928 Series Resettable Circlips Pliers



2928-1 - 4

⊠	⊡
2928-160	1 2928-1
2928-200	1 2928-2
2928-250	1 2928-3
2928-250	1 2928-4

External Horseshoe Circlip Pliers with Chrome Finish



2460

175 mm	1	2460

External Horseshoe Circlip Pliers with Nickel-Chrome Finish and PVC Coated Handles



2465D

200 mm	1	2465D-200

Internal and External Circlip Pliers Set - 4 Pcs



28-29/S4

740 g	1	28-29/S4

2900-180	
2800-180	
2990-180	
2890-180	

Resettable Circlip Pliers Set - 3 Pcs



9938

1640 g	1	9938

2928-160, 2928-200, 2928-250

WIRE STRIPPERS & DISMANTLING TOOLS

ERGO™ Wire Stripping Pliers with Self-Opening Dual-Component Handles and Phosphate Finish



2223G

0.5-5 mm	165 mm	5	2223 G-150



Wire Stripping Pliers with Monomaterial Handles and Phosphate Finish



2223D

0.5-5 mm	165 mm	5	2223 D-150

Automatic Wire Stripping Pliers with Built in Side Cutter and Integrated Scale



3418 A

20-10 AWG	0,5-6 mm ²	3 mm	1 3418 A

Automatic Wire Stripping Pliers



3416 B

0,02-10 mm ²	34-8 AWG	10	3416 B
		10	3416 B SH

Rotating dismantling tool



3520 B

4,5-40 mm	167 mm	10	3520 B
		10	3520 B SH

Automatic Wire Stripping Pliers



3416 A

0,2-6 mm ²	24-10 AWG	6	3416 A
		1	3416 A SH

Rotating dismantling tool



3520 A

0,5-6 mm ²		1	3520 A
		1	3520 A SH

Rotating dismantling tool. 3518ASH spare blade



3518 A

4-28 mm	185 mm	1 3518 A 1 3518 A SH

Stripping Tool for PVC Data Cables



3717 A

115 mm	4.5-10 mm mm	28 g	1 3717 A

Universal dismantling tool with hidden knife



3518 B

0,5-6 mm ²	125 mm	1 3518 B

Wire Stripping Tools for Coaxial Cables



3417 A

4.8-7.5 mm	110 mm	12 3417 A

Wire Stripping Pliers with Anti-Slip Handle



3517 A

6-13 mm	120 mm	1 3517 A

Precision stripping pliers for data cables



3619 A

2,5-11 mm	91 mm	10 3619 A 10 3619 A SH



Precision Stripping Tool



3719 A

0,12-0,8 mm	36-20 AWG	112 mm	12	3719 A

Insertion Tool for LSA Blocks



3718 A

185 mm	0,7-2,6 mm	60 g	12 3718 A

Self-Adjusting Automatic Wire Stripping Pliers with Built in Wire Cutter



3419 B

0.25-6.00 mm	1 3419 B 1 3419 B SH

CRIMPING PLIERS

Crimping/Cutting/Stripping Pliers with Yellow Handle



CR B 01

	AWG		
0.50-6.00 mm ²	20-10	220 mm	60 CR B 01

Crimping/Cutting/Stripping Pliers with Red Handle



CR B 02

	AWG		
1.50-6.00 mm ²	14-10	220 mm	60 CR B 02

Crimping/Cutting/Stripping Pliers with Green Handle



CR B 03

	AWG		
1.50-6.00 mm ²	14-10	220 mm	60 CR B 03

Crimping Pliers for Round Pattern Cable Connections 0.5-2.5 mm²



CR B 05

	AWG			
0.5-2.5 mm ²	20-14	140 mm	2	CR B 05

Ratcheting Crimping Pliers for Insulated Connectors



CR W 01

	AWG			
0.5-6.0 mm ²	20-10	225 mm	1	CR W 01

Crimping Pliers for Round Pattern Cable Connections 0.5-16 mm²



CR B 06

	AWG			
0.5-16 mm ²	20-6	220 mm	2	CR B 06

Ratcheting Crimping Pliers for Non-insulated Connectors



CR W 02

	AWG			
20-10 mm ²	20-10	225 mm	1	CR W 02

Ratcheting Crimping Pliers for Insulated Connectors - Oval Profile



CR OV 01

	AWG			
0.5-6.0 mm ²	20-10	256 mm	1	CR OV 01

Ratcheting Crimping Pliers for Open Plug Type Connectors



CR W 03

	AWG			
0.5-6.0 mm ²	20-10	225 mm	1	CR W 03



Ratcheting Crimping Pliers for High Quality Crimping Connections



CR W 04

RG 58-59-62 mm ²	225 mm	1	CR W 04

Self-Adjusting Crimping Pliers - Square Profile



CR SA S01

	AWG			
0.14-10 mm ²	26-8	176 mm	1	CR SA S01

Ratcheting Crimping Pliers for Tubular Connectors 0.5 AWG-4.0 AWG



CR W 05

AWG			
0.5-4.0	225 mm	1	CR W 05

Self-Adjusting Crimping Pliers - Hexagonal Profile



CR SA H01

	AWG			
0.14-10 mm ²	26-8	176 mm	1	CR SA H01
0.14-16 mm ²	26-6	176 mm	1	CR SA H16

Ratcheting Crimping Pliers for Tubular Connectors 6 AWG-16 AWG



CR W 06

AWG			
6-16	225 mm	1	CR W 06

Self-Adjusting Crimping Pliers - Trapezoidal Profile



CR SA T01

	AWG			
0.14-10 mm ²	26-8	180 mm	1	CR SA T01

Heavy Duty Crimping Pliers for Non-insulated Connectors 600 mm



CR L 01

10-120 mm² 10-95 mm² 600 mm 1 CR L 01

Heavy Duty Crimping Pliers for Non-insulated Connectors 360 mm



CR L 02

6-50 mm² 360 mm 1 CR L 02

Heavy Duty Crimping Pliers for Non-insulated Connectors 650 mm



CR L 03

25-150 mm² 650 mm 1 CR L 03

PLIERS SETS

ERGO™ Fine Mechanical Cutters and Pliers Set - 8 Pcs



9733

30 x 215 x 215 mm 8 1 9733

4130, 4131	
4239	
4830	
4530	
4231	
4430	
4833	

Compact Cutters and Pliers Set C3140, C3640 and C3830 - 3 Pcs



C3901/3

3 1 C3901/3

C3140IP	
C3640IP	
C3830IP	



Compact Cutters and Pliers Set C3330R, C3840 and C3745 - 3 Pcs



C3902/3



3

1 C3902/3

C3330R



C3840



C3745



Compact Pliers and Screwdrivers Set - 8 pcs



C3903/2-6



8

1 C3903/2-6

C3330R



C3840



700-1.5-50, 700-2-50, 700-2.5-50, 700-3-50



701-0-50, 701-1-75



ERGO™ Plumber's Set with 9031 Adjustable Wrench - 2 Pcs



9031-8224



2

693 g

3 9031-8224

BAHCO

9031



8224



ERGO™ Plumber's Set with 9072P Adjustable Wrench - 2 Pcs



9873



25 x 190 x 280 mm

2

1 9873

9072 P



8224



All Round Tool Set - 3 Pcs



9853



25 x 252 x 292 mm

3

1 9853

9071



2101G-160



8224



ERGO™ All Round Pliers Tool Set - 4 Pcs



9897



4

1030 g

1 9897

8224



2628 G-180



2101G-160



2430 G-160



ERGO™ All-Round Pliers Tool Set - 3 pcs



9897G/3



3

50 x 180 x 400 mm

788 g

1 9897G/3

2628 G-180



2101G-160



2430 G-200



LOCKING PLIERS

Grip Locking Pliers with Curved Jaws



2951



1.2 mm

140 mm

1 2951-140

2 mm

190 mm

1 2951-180

3 mm

235 mm

1 2951-250

4 mm	300 mm	1 2951-300
------	--------	------------

Self Grip Locking Pliers with Curved Jaws



2953



140 mm

1 2953-140

190 mm

1 2953-200

235 mm

1 2953-250

300 mm

1 2953-300

Grip Locking Pliers with Straight Jaws



2958



135 mm

1 2958-140

190 mm

1 2958-200

235 mm

1 2958-250

Grip Locking Pliers with Flat Jaws and Longitudinal Section



2968



205 mm

1 2968-190

235 mm

1 2968-235



Grip and Welding Pliers with Multipurpose Jaws



2957



250 mm



1 2957-250

Grip Locking Pliers with Parallel Jaws



2955



235 mm



1 2955-250

Grip Locking Pliers with Long and Slim Jaws



2952



155 mm

230 mm



1 2952-165

1 2952-235

Locking Chain Clamps with Nickel Finish



2999



230 mm

500 mm



1 2999-250

1 2999-SHN

Special Grips for Sheet Metals with Nickel Finish



2967



180 mm



1 2967-180

Chain Pipe Cutters with Chrome Finish



2998



240 mm

330 mm



1 2998-250

1 2998-SHN

Table Locking Clamp



2960



280 mm



1 2960-280

Self Adjusting Parallel Grip Pliers with Swivel Pads



2950



235 mm



1 2950-250

Grip Locking Clamps with C-Clamp



2963



283 mm

458 mm

580 mm



1 2963-280

1 2963-450

1 2963-630

Steel Clamp, Swivel Pads, Slim



2956



282 mm



1 2956-290

Self Adjusting Grip Locking Clamps with Parallel C-Clamp



2964



175 mm

280 mm

436 mm

625 mm



1 2964-160

1 2964-280

1 2964-450

1 2964-600

Stepped C Clamps



2962



290 mm

290 mm

290 mm



1 2962-8-150

1 2962-8-230

1 2962-8-300



Special Grip and Locking U-Clamps



2965



228 mm
290 mm



1 2965-200
1 2965-280

Special Grips for Tubes and Pipes



2966



290 mm



1 2966-280

Locking Pliers Spare Parts



2951-S



43 mm	15 g	1	2951-S05
46 mm	25 g	1	2951-S07
62 mm	50 g	1	2951-S10
87 mm	70 g	1	2951-S12

Universal Grip Pliers with 4 Positions Long Jaws



2997



255 mm



5 2997-300

Universal Grip Pliers with 4 Positions Short Jaws



2997-250



235 mm



1 2997-250

Automatic Hand Vices with Phosphate Finish



2949



193 mm
196 mm
240 mm
240 mm



1 2949-190IP
1 2949-200IP
1 2949-240IP
1 2949-250IP

Hand Vices Spare Bolt



2949-L

2949-190IP	75 mm	1	2949-L075
2949-200IP, 2949-240IP	120 mm	1	2949-L120
2949-250IP	200 mm	1	2949-L200

Notching pliers.



2690

200 mm	10	2690

RIVETING TOOLS

Hand Riveters with 360° Swivel Head



2681

285 mm	12	2681

Long Arm Riveters with Transparent Tube Collects



1467-520

530 mm	1	1467-520

Hand Riveters with Exchangeable Heads



1467-250

255 mm	1	1467-250

Extensible Riveters for Cu/Al and Stainless Steel



1467-320-850

850 mm	1	1467-320-850



Spare Parts for 1467 Series Riveter



1467



10 g
10 g



1 1467-LJ
1 1467-SJ

Spare Part Set for 2681 Series Riveter - 4 Pcs



2681-1



15 g



1 2681-1

SPECIAL PLIERS

Automatic Wire Tie Tensioning Tools for Electric Nylon Ties



790450A



<2.2x5 mm



1 790450A

Wire Tie Tensioning Tools for Electric Nylon Ties



790455A



<9.5x2.3 mm



1 790455A

Wire Twisting Pliers with Phosphate Finish



2855



236 mm
287 mm

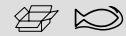

1 2855
1 2855 D

Wire Twisting Pliers, One-hand Operation



2856



203 mm
268 mm



1 2856-8
1 2856-10



Pipe Wrenches & Tubing Tools



PIPE WRENCHES

ERGO™ Quick-Adjust Pipe Wrenches



1610/1620

L	max		
320 mm	1 in	1	1610
430 mm	1 1/2 in	1	1620

10 times faster vs standard model

ERGO™ Swedish Model 90° Pipe Wrenches



1410/1420

L	max		
320 mm	1 in	1	1410
430 mm	1 1/2 in	1	1420

ERGO™ Swedish Model 90° Pipe Wrenches with Soft-Touch Shank



1410D/1420D

L	max		
320 mm	1 in	1	1410D
430 mm	1 1/2 in	1	1420D

Swedish Model 90° Pipe Wrenches



140-147

L	max		
210 mm	3/4 in	1	140
320 mm	1 in	1	141
426 mm	1 1/2 in	1	142
557 mm	2 1/2 in	1	143
722 mm	3 1/2 in	1	144
1060 mm	5 in	1	147

Spare Nuts for Quick-Adjust Pipe Wrenches



1610-nut/1620-nut

Ø	g		
11 mm	34 g	1	1610-NUT
11.5 mm	48 g	1	1620-NUT

Swedish Model 90° Pipe Wrench with Green Powder Coat



DOW175

L	max		
310 mm	1 in	1	DOW 175-1
420 mm	1 1/2 in	1	DOW 175-11/2
560 mm	2 in	1	DOW 175-2
630 mm	3 in	1	DOW 175-3

Corner Pipe Wrench



442 B-444 B

L	max		
320 mm	1 in	1	442 B
430 mm	2 in	1	443 B
545 mm	2 1/2 in	1	444 B

Swedish Model Corner Combination Pipe Wrench



341-344

L	max		
230 mm	1/2 in	1	341
330 mm	1 in	1	342
420 mm	1 1/2 in	1	343
530 mm	2 in	1	344

Swedish Model Corner Combination Pipe Wrench with Green Powder Coat



DOW177

L	max		
325 mm	1 in	1	DOW 177-1/2-1
425 mm	1 1/2 in	1	DOW 177-11/2
534 mm	2 in	1	DOW 177-2

Swedish Model 45° Corner Pipe Wrench with Green Powder



DOW176

L	max	Icon	Icon
330 mm	1 in	1	DOW 176-1
415 mm	1 1/2 in	1	DOW 176-11/2
530 mm	2 in	1	DOW 176-2

Spare Fixed Jaw for Aluminium Pipe Wrenches



8100F

L	g	Icon	Icon
380-18	90 g	1	8100F0180
380-24	180 g	1	8100F0240

Mobil Jaws for Stillson Wrench



8060B

L	g	Icon	Icon
361-8	80 g	1	8060B0080
361-10	200 g	1	8060B0100
361-12	270 g	1	8060B0120
361-14	330 g	1	8060B0140
361-18	520 g	1	8060B0180
361-24	970 g	1	8060B0240
361-36	1630 g	1	8060B0360

Multipurpose Aluminium Pipe Wrenches



380

L	max	Icon	Icon
253 mm	1.1/2 in	1	380-10
320 mm	2 in	1	380-14
455 mm	2.1/2 in	1	380-18
607 mm	3 in	1	380-24
910 mm	4 in	1	380-36
1210 mm	6 in	1	380-48

Spare Nuts for Aluminium Pipe Wrench



8100T

L	g	Icon	Icon
380-10	30 g	1	8100T0100
380-14	45 g	1	8100T0140
380-18	70 g	1	8100T0180
380-24	110 g	1	8100T0240
380-36	220 g	1	8100T0360
380-48	310 g	1	8100T0480

Spare Nut for Stillson Wrench



8060T

L	g	Icon	Icon
361-8	20 g	1	8060T0080
361-10	20 g	1	8060T0100
361-14	40 g	1	8060T0140
361-18	70 g	1	8060T0180
361-24	90 g	1	8060T0240
361-36	250 g	1	8060T0360

Spare Mobil Jaws for Aluminium Pipe Wrenches



8100B

L	g	Icon	Icon
380-14	430 g	1	8100B0140
380-18	680 g	1	8100B0180
380-24	1000 g	1	8100B0240
380-36	1810 g	1	8100B0360

Stillson Pipe Wrenches



361

L	max	Icon	Icon
185 mm	1 in	1	361-8
230 mm	1.1/2 in	1	361-10
265 mm	1.3/4 in	1	361-12
315 mm	2 in	1	361-14
450 mm	2.1/2 in	1	361-18
535 mm	3 in	1	361-24
900 mm	4 in	4	361-36

Heavy Duty Chain Pipe Wrenches



372

L	Icon	Icon
1.1 in	1	372-1.1/2
2.1 in	1	372-2.1/2
4 in	1	372-4
6 in	1	372-6
8 in	1	372-8
12 in	1	372-12



Spare Chains For Special Pipe Wrenches



3074

L	Icon	Icon	Icon
340 mm	372-1.1/2	1	307401B
475 mm	372-2.1/2	1	307411B
560 mm	372-4	1	307421B
830 mm	372-6	1	307431B
1000 mm	372-8	1	307441
1400 mm	372-12	1	307451

Telescopic Basin Wrenches with 4 Positionings



363

L	Icon	Icon	Icon
280 mm		1	363-32

Pipe Cutters 3 mm-35 mm



402-35

Icon	Icon	Icon
3-35 mm		6 402-35

Chain Pipe Wrenches with Steel Handle



370

L	Icon	Icon	Icon
300 mm		1	370-4

Pipe Cutters



401-16

Icon	Icon	Icon	Icon
3-16 mm		12	401-16

Pipe Cutters with Quick Adjust System



402-76

Icon	Icon	Icon	Icon
12-76 mm		6	402-76

Special Pipe Wrenches with Nylon Strap and Steel Handle



375

L	Icon	Icon	Icon
300 mm		50	375-8

Pipe Cutters 3 mm-28 mm



401-28

Icon	Icon	Icon	Icon
3-28 mm		12	401-28

Automatic Tube Cutter 10-22 mm



306-

Icon	Icon	Icon	Icon
10 mm		1	306-10
12 mm		1	306-12
15 mm		12	306-15
22 mm		12	306-22

Compact Tube Cutter 3-16 mm



301-16

3-16 mm	72 mm	12	301-16

Tube Cutter 35-75 mm



302-76

	1	302-76-95

Spare Wheels Set and Pin for 301/302 Pipe Cutters



302-95-SET

30 g	1	302-95-SET

Compact Tube Cutter 3-22 mm



301-22

3-28 mm	12	301-22

Tube Cutter with Quick Adjust System 12-76 mm



302-76N

12-76 mm	318 mm	6	302-76N

Spare Cutting Wheels for 306 Series Tube Cutters



306-15-95

10 g	1	306-15-95

Tube Cutter 8-35 mm



302-35

3-35 mm	6	302-35

Spare Cutting Wheels for 301/302 & 401/402 Series Tube Cutters



302/402-15-95

301-16,301-22, 302-35,302-75N	5 g	100	302-15-95
401-16,401-28, 402-35,402-75	5 g	1	402-15-95

Spare Wheels and Pins for 401/402 Pipe Cutters



402-95-SET

30 g	1	402-95-SET



Plastic Tube Cutter



311-32

32 mm	6	311-32

Plastic Pipe Scissors for Multilayer



412-26-MULTI

26 mm	5	412-26-MULTI

Spare Blades for 412-26-MULTI Plastic Pipe Cutters



412-26-MULTI-95

1	10 g	150	412-26-MULTI-95

Plastic Pipe Scissors



411

26 mm	4	411-26
35 mm	4	411-35
42 mm	6	411-42
63 mm	5	411-63

Spare Blades for Plastic Pipe Scissors



411-95

1	39 g	50	411-26-95
1	37 g	50	411-35-95
1	41 g	50	411-42-95
1	48 g	30	411-63-95

BENDING & FORMING TOOLS

Multipurpose Tube Bender



1084

250 mm	6,8 10 mm	5	1084

Plastic Pipe Scissors for PEX



412-28-PEX

28 mm	5	412-28-PEX

Spare Blades for 412-28-PEX Pipe Scissors



412-28-PEX-95

1	35 g	30	412-28-PEX-95

Tube Bender



500

12 mm	1	500-12
14 mm	1	500-14
15 mm	1	500-15
16 mm	1	500-16
18 mm	1	500-18
22 mm	1	500-22

Tube Flaring Tool In Metric Sizes



4480MM

45°	4, 6, 8, 10, 12, 14, 16, 18 mm	1	4480MM

Imperial Tube Flaring Tool



4480IM

45°	5/8, 3/16, 1/4, 5/16, 3/8, 7/16, 1/2, 3/4 in	1	4480IM

Tube Cutter and Double Flaring Tool Set



4480/

45 x 140 x 330 mm	1	4480/2-ZD

DEBURRING TOOLS

Aluminium Pen Reamer



316-1

143 mm	12	316-1

Plastic Pen Reamer



316-2

150 mm	12	316-2

Spare Blade for 316-2 Pen Reamer



316-2-95

3 g	1	316-2-95

Aluminium Wheel Reamer



318-38/318-54

8-38 mm 10-54 mm	1 1	318-38 318-54

Plastic Wheel Reamer



317-40

3-40 mm	12	317-40





BAHCO



Air Tools



IMPACT WRENCHES

3/8" Square Drive Mini Impact Wrenches



BP704

BAR



6.3 bar 1500 min 1 BP704

3/8" Square Drive Lightweight Impact Wrenches with Twin Hammer Mechanism



BPC816

BAR

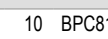

12.000 min 6,3 bar 10 BPC816

1/2" Square Drive Angle Impact Wrenches with Jumbo Hammer Mechanism



BP814A

BAR

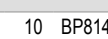

7000 min 6.2 bar 10 BP814A

1/2" Impact Wrenches with Twin Hammer Mechanism 360 N.m



BP814

BAR

10,000 min 6.3 bar



10 BP814

1/2" Impact Wrenches with Twin Hammer Mechanism 620 N.m



BP815

BAR

7,000 min 6.3 bar



1 BP815

1/2" Impact Wrench Kit - 13 Pcs



BP815K1

BAR

7,000 min 6.3 bar



1 BP815K1

BP815

K7800M-10, K7800M-11, K7800M-12, K7800M-13, K7800M-14, K7800M-15, K7800M-17, K7800M-19, K7800M-22, K7800M-24, K7800M-21

PM5142

1/2" Impact Wrench Kit - 3 Pcs



BP815K2

BAR

7,000 min 6.3 bar



1 BP815K2

1/2" Square Drive Micro Impact Wrenches with Twin Hammer Mechanism



BPC813

BAR

10000 min 6,3 bar



10 BPC813

1/2" Square Drive Micro Impact Wrench Set with Ultra Short Sockets



BPC813K1

BAR

1/2 in 65 x 162 x 215 mm



1 BPC813K1

BPC813

K7800M-13, K7800M-14, K7800M-16, K7800M-17, K7800M-19, K7800M-21, K7800M-22, K7800M-24

1/2" Composite Impact Wrenches with Twin Hammer Mechanism 338 N.m



BPC814



BAR



12000 min 6,3 bar 10 BPC814

1/2" Composite Impact Wrenches with Twin Hammer Mechanism 786 N.m



BPC815



BAR



8000 min 6,3 bar 1 BPC815

1/2" Square Drive Impact Wrench Set with 11 Metric Sockets



BPC815K1



1/2 in 90 x 230 x 390 mm 1 BPC815K1

BPC815

K7801M-10, K7801M-11, K7801M-12, K7801M-13, K7801M-14, K7801M-15, K7801M-17, K7801M-19, K7801M-21, K7801M-22, K7801M-24



1/2" Square Drive Impact Wrench Set with 5 Metric Sockets



BPC815K2



1/2 in 90 x 230 x 320 mm 1 BPC815K2

BPC815

K7801M-19, K7801M-22, K7801M-24, K7801M-17, K7801M-13



1/2" Square Drive Impact Wrench Set with 5 Imperial Sockets



BPC815K3



1/2 in 90 x 230 x 320 mm 1 BPC815K3

BPC815

K7801Z-1/2, K7801Z-5/8, K7801Z-3/4, K7801Z-7/8, K7801Z-15/16



1/2" Square Drive Impact Wrench Set with 5 Wheel Metric Sockets



BPC815K4



1/2 in 90 x 230 x 320 mm 1 BPC815K4

BPC815



BWSS12P5



1/2" Square Drive Impact Wrench Set with 2 Wheel Metric Sockets



BPC815K6



1/2 in 90 x 230 x 320 mm 1 BPC815K6

BPC815

BWSS12P319, BWSS12P317



3/4" Impact Wrenches with Twin Hammer Mechanism 950 N.m



BP817



BAR



4,500 min 6,3 bar 1 BP817

3/4" Square Drive Lightweight Impact Wrenches with Twin Hammer Mechanism



BPC817



BAR



5000 min 6,2 bar 4 BPC817



3/4" Square Drive Impact Wrench Set with 4 Metric Sockets



BPC817K1

3/4 in 105 x 295 x 390 mm 1 BPC817K1

BPC817

K8901M-24, K8901M-27, K8901M-32, K8901M-30



3/4" Square Drive Impact Wrench Set with 4 Imperial Sockets



BPC817K2

3/4 in 105 x 295 x 390 mm 1 BPC817K2

BPC817

K8901Z-15/16, K8901Z-1, K8901Z-1.1/16, K8901Z-1.1/8



1" Square Drive Lightweight Impact Wrenches with Durable Rocking Dog Mechanism



BP901

3800 min **BAR** 6.2 bar 1 BP901

1" Square Drive Lightweight Impact Wrenches with Durable Rocking Dog Mechanism and 9" Anvil



BP901L

3800 min **BAR** 6.2 bar 1 BP901L

1" Square Drive Lightweight Impact Wrenches with Twin Hammer Mechanism and Long Anvil



BP905L

6000 min **BAR** 6.2 bar 2 BP905L

1" Square Drive Lightweight Impact Wrenches with Twin Hammer Clutch Mechanism



BP905P

6000 min **BAR** 6.2 bar 2 BP905P

Impact Wrench Boots with Rubber Protection



BPM91B

85 x 80 x 180 mm 162 g 1 BPM91BOOT

1" Square Drive Lightweight Impact Wrenches with Twin Hammer Mechanism and Short Anvil



BP905S

6000 min **BAR** 6.2 bar 2 BP905S

Impact Wrench Silencer Kit



BPM91MK

30 x 25 x 25 mm 5 g 1 BPM91MK1
30 x 25 x 50 mm 10 g 1 BPM91MK2

RATCHETS

1/4" Mini Air Ratchets with Power Regulator



BP700

	BAR		
300 min	6.3 bar	20	BP700

1/2" Ratchets with Rubber Grip



BP821

	BAR		
150 min	6.3 bar	1	BP821

GRINDERS, SANDERS & POLISHERS

Angle Die Grinders with Rubber Grip



BP115

	BAR		
20,000 min	6.3 bar	1	BP115

3/8" Square Drive Stubby Air Ratchets



BP721

	BAR		
350 min	6.3 bar	1	BP721

1/2" Square Drive Reactionless Impact Ratchet



BPR821

	BAR		
600 min	6.3 bar	1	BPR821

Low Revolution Air Grinder/Tyre Buffers with Hex Quick Change Chuck



BP117

	BAR		
2500 min	6.3 bar	1	BP117

3/8" Air Ratchets with Power Regulator



BP820

	BAR		
270 min	6.3 bar	1	BP820

Air Ratchet Boots for 1/4" Ratchets



BP91B

35 x 40 x 60 mm	12 g	1	BP91BL
30 x 30 x 45 mm	6 g	1	BP91BS

Low Speed Air Grinder/Tyre Buffers with Keyed Chuck



BP118

	BAR		
2500 min	6.3 bar	1	BP118



Die Grinders with Rubber Grip



BP822

	BAR		
25,000 min	6.3 bar	1	BP822

Coarse Grinding Bullet Abrasive Wheels with 6 mm Shank - 2 Pcs/Blister Pack



BP421M

53 mm	14 mm	1	BP421M

Coarse Grinding 90° Cone Abrasive Wheels with 6 mm Shank - 2 Pcs/Blister Pack



BP424M

57 mm	19 mm	1	BP424M

Air Die Grinders with 6 mm Shank, Long Anvil and Rubber Grip



BP822E

	BAR		
25000 min	6.3 bar	10	BP822E

Coarse Grinding Cylindrical Abrasive Wheels with 6 mm Shank - 2 Pcs/Blister Pack



BP422M

46 mm	26 mm	1	BP422M

Fine Grinding Conical Round Nose Abrasive Wheels with 3 mm Shank - 2 Pcs/Blister Pack



BP430M

55 mm	12 mm	1	BP430M

Coarse Grinding Conical Round Nose Abrasive Wheels with 6 mm Shank - 2 Pcs/Blister Pack



BP420M

67 mm	25 mm	1	BP420M

Coarse Grinding Spherical Abrasive Wheels with 6 mm Shank - 2 Pcs/Blister Pack



BP423M

53 mm	25 mm	1	BP423M

Fine Grinding Small Bullet Abrasive Wheels with 3 mm Shank - 2 Pcs/Blister Pack



BP431M

54 mm	13 mm	1	BP431M

BAHCO

Fine Grinding Small 90° Cone Abrasive Wheels with 3 mm Shank - 2 Pcs/Blister Pack



BP432M

44 mm	15 mm	1	BP432M

Reversible Cut-Off Tools



BP110

	BAR		
18,000 min	6.3 bar	1	BP110

Exhaust Hoses for BP117 Low Revolution Grinder/Tyre Buffers



BP117EH

50 x 100 x 50 mm	1 kg	1	BP117EH

Fine Grinding Small Tapered Ball Abrasive Wheels with 3 mm Shank - 2 Pcs/Blister Pack



BP433M

43 mm	14 mm	1	BP433M

Disc Grinders with Rubber Grip and Safety Trigger



BP823

	BAR		
10,000 min	6.3 bar	1	BP823

Surface Cleaners with 19 Needles



BP127

	BAR		
3700 min	6.3 bar	1	BP127

Fine Grinding Small Cylindrical Abrasive Wheels with 3 mm Shank - 2 Pcs/Blister Pack



BP434M

45 mm	13 mm	1	BP434M

4"/102 mm Extended Air Cut-Off Tools



BP111E

	BAR		
15000 min	6.3 bar	12	BP111E

Pistol Grip Surface Cleaners with 19 Needles



BP127P

	BAR		
3800 min	6.3 bar	1	BP127P



Needle Set



BP12718



BP127, BP127P 3 mm 1 BP12718

Rubber Dish Solvent Based



BP830ESB



30 mm 105 mm 1 BP830ESB

Straight Bristles Adaptor



BP830SBA

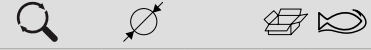

BP830K 105 mm 1 BP830SBA

Coarse Inclined Steel Bristles



BP830CISB

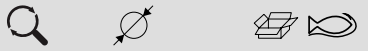

BP830K 105 mm 1 BP830CISB

Rubber Eraser, Water Based



BP830EWB



BP830K 105 mm 1 BP830EWB

Straight Steel Bristles



BP830SSB

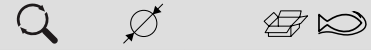

BP830K 105 mm 1 BP830SSB

Air Blaster Kit



BP830K



4000 min 6.3 bar 4 BP830K

Straight Steel Bristles

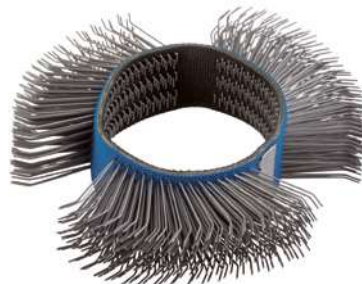

BP830MISB



BP830K 105 mm 1 BP830MISB

Stripping Wheel



BP830SW



BP830K 105 mm 1 BP830SW

Pistol-Grip Air Sander Set - 71 Pcs



BP204K

	BAR		
15000 min	6.3 bar	1	BP204K

BP20425180, BP20410800, BP20410320, BP20425220

BP204

Sanding Pads for BP204 Pistol-Grip Sander



BP204PAD

77 mm	-	1	BP204PAD

Belt Sanders with Quick Belt Release Button



BP212

	BAR		
16,000 min	6.3 bar	1	BP212

Orbital Sander Pads with Velcro Pad



BP51137

152 mm	x	1	BP51137

5 mm Palm Orbital Sanders with Velcro Pad



BP601

	BAR		
152 mm	6.3 bar	1	BP601

Velcro Pad 53 Holes



BP60102

BP601	152 mm	1	BP60102

3" Pistol Grip Orbital Air Sanders with Rubber Grip



BP204

	BAR		
15000 min	6.3 bar	1	BP204

Sanding Discs for 3" Wheel Sanders



BP204xyyy

77 mm		1	BP20410320
77 mm		1	BP20410800
77 mm		1	BP20425180
77 mm		1	BP20425220

20 mm Belt Sanders with Quick Belt Release Button



BP222

	BAR		
16,000 min	6.3 bar	1	BP222



2.5 mm Palm Orbital Sanders with Velcro Pad



BP610

	BAR	
152 mm	6.3 bar	1 BP610

7" Vertical Air Polishers with Rubber Grip



BP810

	BAR	
2500 min	6.3 bar	1 BP810

1/2" Reversible Air Drills 800 rpm



BPC825

	BAR	
800 min	6.3 bar	1 BPC825

Pack of 25 Belts for Belt Sanders



BPN22201/21201

10 mm	1 BPN21201
20 mm	1 BPN22201

7" Wool Bonnets



BP80950

178 mm	15 g
	1 BP80950

3/8" Compact Reversible Air Drills 2,000 rpm



BPC823

	BAR	
2000 min	6.3 bar	1 BPC823

DRILLS & SCREWDRIVERS

7" Air Angle Polishers with Rubber Grip and Spindle Lock



BP809

	BAR	
2500 min	6.3 bar	1 BP809

1/2" Reversible Drills with Rubber Grip 13 mm



BP825

	BAR	
450 min	6.3 bar	1 BP825

3/8" Compact Angle Air Drills 1,400 rpm



BPA823

	BAR	
1400 min	6.3 bar	1 BPA823

1/4" Air Screwdrivers 1800 rpm



BP826

	BAR		
1800 min	6.3 bar	1	BP826

1/4" Air Screwdrivers 800 rpm



BP827

	BAR		
800 min	6.3 bar	1	BP827

CUTTING TOOLS

Compact Reciprocating Saws with Safety Trigger



BP828

	BAR		
10000 min	6.3 bar	1	BP828

Reciprocating Saws with Safety Trigger



BP824

	BAR		
10,000 min	6.3 bar	1	BP824

Geared Reciprocating Saws with Safety Trigger



BPG824

	BAR		
7400 min	6.3 bar	10	BPG824

Windscreen Removers with Low Vibration



BP233

	BAR		
20	6.3 bar	1	BP233

Flat and Jagged Straight Blades



BPBG

15 mm	1	BPBG3515
25 mm	1	BPBG3525A
25 mm	1	BPBG3525B

Offset Comma Shaped Blades - 2 Pcs/Blister Pack



BPBK

30 mm	1	BPBK30

Scrapers - 2 Pcs/Blister Pack



BPBSC

15 mm	1	BPBSC156



U Shaped Blades - 2 Pcs/Blister Pack



BPBU

L	
18 mm	1 BPBU18
24 mm	1 BPBU24
36 mm	1 BPBU36
60 mm	1 BPBU60
90 mm	1 BPBU90

Air Metal Shears with Rubber Grip and Safety Trigger



BP811

min ⁻¹	BAR	
2,600 min	6.3 bar	1 BP811

Straight Offset Blades - 2 Pcs/Blister Pack



BPBG5725/9057

L	
57 mm	1 BPBG5725
90 mm	1 BPBG9057

HAMMERS, RIVETERS & MARKERS

Air Hammers 3200 bpm



BP910

BAR	(min ⁻¹)	
6.3 bar	3200	5 BP910

Rotating Flat Chisels with 10.2 mm Shank



BP909TF

L	
170 mm	1 BP909TF

Rotating Wide Flat Chisels with 10.2 mm Shank



BP909TWF

L	
170 mm	1 BP909TWF

Rotating Tapered Punch Chisels with 10.2 mm Shank



BP909TTP

L	
165 mm	1 BP909TTP

Rotating Edging Chisels with 10.2 mm Shank



BP909TE

L	
139 mm	1 BP909TE

Rotating Hammer Chisels with 10.2 mm Shank



BP909TH

L	
108 mm	1 BP909TH

Rotating Straight Punch Chisels with 10.2 mm Shank



BP909TSP



165 mm



1 BP909TSP

Non-Rotating Flat Chisels with 10.2 mm Shank



BP909NF



190.5 mm



1 BP909NF

Non-Rotating Edging Chisels with 10.2 mm Shank



BP909NE



173 mm



1 BP909NE

Air Riveters 880 kg pulling force



BP277K

BAR



6.3 bar

14



8 BP277K

Air Riveters 1600 kg pulling force



BP125A

BAR



6.3 bar

19



6 BP125A

Carbide Tips for Air Engraving Pen



BP79912



10 g



1 BP79912

Air Caulking Guns with 300 ml Cartridge Applicator



BP215A

BAR

3.5-4.8 bar



10 BP215A

PAINT GUNS

HVLP Spray Painting Guns



Air Engraving Markers with Low Vibration



BP799



13,000 min⁻¹

BAR

6.3 bar



1 BP799

BPHVLP01



0.7 kg

BAR

2-2.8 bar



1 BPHVLP01



Nozzle Set for BPHVLP01 HVLP Painting Spray Guns



BPHVLP

1.2 mm	1	BPHVLP0112
1.4 mm	1	BPHVLP0114
1.7 mm	1	BPHVLP0117
2.0 mm	1	BPHVLP0120

BLOWING & CLEANING TOOLS

Air Blow Guns with Brass Inlet



**BP218
BAR**

6.3 bar	1 BP218

Air Blow Guns with Brass Inlet and Removable Safety Tip



**BP219
BAR**

6.3 bar	1 BP219

Air Blow Guns with Brass Inlet and Removable Safety Tip Long Nozzle



**BP219L
BAR**

6.3 bar	1 BP219L

Air Blow Guns with Brass Inlet 1 m Extra Long Nozzle



**BP219XL
BAR**

6.3 bar	100 l/min	10 BP219XL

Air Blow Vacuum Guns with Removable Safety Tip



**BP219V
BAR**

6.3 bar	1 BP219V

Cleaning Guns with Steel Nozzle



**BPN010
BAR**

6.2 bar	6000-7500 min	1 BPN010

AIR TOOLS ACCESSORIES & EQUIPMENT

Magnetic Holders for Impact and Torque Wrenches



BP500

0.380 kg	1 BP500	

1/2" Filter Regulator Units



BP254

max 3800 L/min	l/min 1-8.5 bar	1 BP254

1/2" Filter Regulator and Lubricator Units



BP255

	BAR		
max 3,800 l/min	1-8.5 bar	1	BP255

Additional clean dry air outlet for 1/2" filter regulator and lubricator units with type T clean dry air outlet



BP255T-1

	BAR		
max 3800 l/min	1-8.5 bar	1	BP255T-1

Spiral Air Hoses with Threaded Connector 13 mm



BPH1310

1/2"-1/2" in	10 m	1	BPH1310A

1/4" Inline Lubricators



BPN251

1/4" in	0.100 kg	1	BPN251	

Spiral Air Hoses with Threaded Connector 10 mm



BPH1010

1/4"-1/4" NPT in	10 m	1	BPH1010A
1/4"-1/4" BSP in	10 m	1	BPH1010B

Speed Control Adaptors for Rewinding Speed Control



BPHRSC

76 x 88 x 114 mm	1	BPHRSC

1/2" Filter Regulator and Lubricator Units with Type T Clean Dry Air Outlet



BP255T

	BAR		
max 3800 l/min	1-8.5 bar	1	BP255T

Air Hose Reels with 145° Swivel Steel Bracket and Optional Speed Control Adaptor



BPHRC815/1015

8 mm	15 m	1	BPHRC815
10 mm	14+1 m	1	BPHRC1015

Air Hose Reels with 145° Swivel Steel Bracket



BPHRC1020/1316

10 mm	20 m	1	BPHRC1020
13 mm	15+1 m	1	BPHRC1316



Air Hose Reels with 90° Swivel Base



BPHRO1315



13 mm

13+2 mm

1 BPHRO1315

1/4" Swivel Air Connectors



BPSJ



1/4" in

1 BPSJ

1/4" Swivel Air Connectors with Rotation Lock System



BPSJL



1/4" in

1 BPSJL



Cordless Power Tools



IMPACT WRENCHES

12 V 1/4" Square Drive Cordless Impact Wrenches



BCL31IW1



1 BCL31IW1

12 V

1/4"

14.4 V 3/8" Square Drive Cordless Brushless Impact Wrench Kit



BCL32IW1K1



110 x 310 x 390 mm 3.6 kg 1 BCL32IW1K1

BCL32IW1

BCL32B1x 2

BCL31C1

18 V 1/2" Square Drive Cordless Impact Wrenches



BCL33IW1



18 V 1/2" 1 BCL33IW1

12 V 1/4" Square Drive Cordless Impact Wrench Kit



BCL31IW1K1



1 BCL31IW1K1

110 x 310 x 390 mm 3.1 kg

BCL31B1x 2

BCL31C1

BCL31IW1

18 V 1/2" Square Drive Cordless Impact Wrench Kit



BCL33IW1K1



110 x 310 x 390 mm 5.77 kg 10 BCL33IW1K1

BCL33C1

BCL33IW1

BCL33B3x 2

18 V 1/2" Square Drive Cordless Brushless Impact Wrench Kit



BCL33IW2K1



110 x 310 x 390 mm 6.47 kg 1 BCL33IW2K1

BCL33IW2

BCL33C1

BCL33B3x 2

14.4 V 3/8" Square Drive Cordless Brushless Impact Wrenches



BCL32IW1



1 BCL32IW1

14.4 V

3/8"

18 V 1/2" Square Drive Cordless Brushless Impact Wrenches



BCL33IW2



18 V 1/2" 1 BCL33IW2

RATCHETS

12 V 1/4" Cordless Square Drive Ratchet Wrenches



BCL31R1



12 V 1/4" 1 BCL31R1

12 V 1/4" Cordless Square Drive Ratchet Wrench Kit



BCL31R1K1

110 x 310 x 390 mm 3.1 kg 1 BCL31R1K1

- BCL31B1x 2**
- BCL31C1**
- BCL31R1**

DRILLS & SCREWDRIVERS

18 V 1/2"-13 mm Cordless Brushless Drill Drivers



BCL33D1

18 V 1/2 in 1 BCL33D1

18 V 1/2"-13 mm Cordless Drill Driver Kit



BCL33D1K1

110 x 310 x 390 mm 3.7 kg 1 BCL33D1K1

- BCL33C1**
- BCL33D1**
- BCL33B1x 2**

12 V 3/8"-10 mm Cordless Drill Drivers



BCL31D1

12 V 360/1550 min 1 BCL31D1

12 V 3/8"-10 mm Cordless Drill Driver Kit



BCL31D1K1

110 x 310 x 390 mm 3.15 kg 1 BCL31D1K1

- BCL31B1x 2**
- BCL31C1**
- BCL31D1**

12 V 1/4" Cordless Compact Impact Drivers with Quick Release Hex Drive



BCL31IS1

12 V 1/4 in 1 BCL31IS1

12 V 1/4" Cordless Compact Impact Driver with Quick Release Hex Drive Kit



BCL31IS1K1

110 x 310 x 390 mm 3.1 kg 1 BCL31IS1K1

- BCL31B1x 2**
- BCL31IS1**
- BCL31C1**

12 V 1/4" Cordless Two Speed Drivers



BCL31SD1

12 V 1/4 in 1 BCL31SD1

12 V 1/4" Cordless Two Speed Driver Kit



BCL31SD1K1

110 x 310 x 390 mm 2.99 kg 1 BCL31SD1K1

- BCL31SD1**
- BCL31B1x 2**
- BCL31C1**



GRINDERS, SANDERS & POLISHERS

14.4 V Cordless 2" Sanders and 3" Polishers





BCL32SP1

V   
14.4 V 1900/6900 min 1 BCL32SP1

18 V Cordless Orbital Angle Polishers with 5" Pad







BCL33AP1



V   
18 V 1100-3500 min 1 BCL33AP1

14.4 V Cordless 2" Sanders and 3" Polishers Kit



BCL32SP1K1





   
265 x 290 x 480 mm 3.29 kg 1 BCL32SP1K1



BCL32SP1 
BCL32B1x 2 
BCL31C1 

18 V Cordless Orbital Angle Polisher Kit with 5" Pad



BCL33AP1K1

   
265 x 290 x 480 mm 5.78 kg 1 BCL33AP1K1

BCL33AP1 
BCL33B3x 2 
BCL33C1 

14.4 V 6 mm Cordless Collet Die Grinders







BCL32DG1



V   
14.4 V 21000 min 1 BCL32DG1

14.4 V 6 mm Cordless Collet Die Grinder Kit



BCL32DG1K1





   
110 x 310 x 390 mm 3.2 kg 1 BCL32DG1K1



BCL32DG1 
BCL32B1 
BCL31C1 

14.4 V Cordless Greaser Kit with GR-400 Container



BCL32G1K1

   
265 x 290 x 480 mm 5.22 kg 1 BCL32G1K1

BCL32G1 
BCL31C1 
BCL32B1x 2 

CUTTING TOOLS

14.4 V Cordless Reciprocating Saws



BCL32RS1

V   
14.4 V 3000 min 1 BCL32RS1

14.4 V Cordless Reciprocating Saw Kit



BCL32RS1K1

   
265 x 290 x 480 mm 3.5 kg 1 BCL32RS1K1

BCL32RS1



BCL32B1x 2



BCL31C1



GREASERS

14.4 V Cordless Greasers with GR-400 Container Capacity



BCL32G1

V



14.4 V

400 g

1 BCL32G1

BATTERIES & CHARGERS

12 V 2 Ah Lithium-Ion Batteries



BCL31B1

V



12 V

2 A-h

1 BCL31B1

14.4 V 2 Ah Lithium-Ion Batteries



BCL32B1

V



14.4 V

2 A-h

1 BCL32B1

18 V 2 Ah Lithium-Ion Batteries



BCL33B1

V



18 V

2 A-h

1 BCL33B1

18 V 5 Ah Lithium-Ion Batteries



BCL33B3

V



18 V

2 A-h

1 BCL33B3

12 V-14.4 V 3 A Battery Chargers



BCL31C1

V_{in}

V_{out}



220 V

12/14.4 V

1 BCL31C1

18 V 2.3 A Battery Chargers



BCL33C1

V_{in}

V_{out}



220 V

18 V

1 BCL33C1

18 V 3.4 A Quick Battery Chargers



BCL33C2

V_{in}

V_{out}



220 V

18 V

1 BCL33C2





BAHCO



Automotive Tools



ENGINE TOOLS

Timing kit for FCA Group 1.4 Multiair engines



BE501101



68 x 225 x 280 mm

1 BE501101

BE50110101



BE50110102



BE50110103



BE50110104



Timing kit for FCA Group 0.9 petrol Twinair



BE501102



68 x 225 x 280 mm

1 BE501102

BE50110201



BE50110202



BE50110203



Timing kit for FCA Group 1.6-1.9-2.0-2.4 diesel



BE501203



68 x 225 x 280 mm

1 BE501203

BE50120301



BE50120302



BE50120303



BE50120305



BE50110103



BMW crankshaft harmonic balancer holder



BE502104



60 x 98 x 269 mm 1726 g 8 BE502104

BMW crankshaft holding tool



BE502106



80 x 70 x 260 mm

10 BE502106

BE50110201



BE50110202



BE50110203



Timing kit for FCA Group 1.3 JTD MJ



BE501204



68 x 225 x 280 mm

1 BE501204

BE50120401



BE50120402



BE50120403



BE50120404



BE50120405



Timing kit for BMW 1.8-2.0 petrol

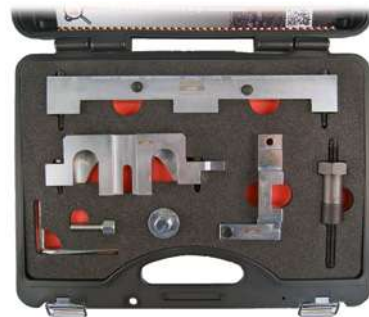

BE502101



95 x 270 x 350 mm

1 BE502101

BE50210101



BE50210102



BE50210103



BE50210104



BE50210105



BE50210106



BE50210107



Timing kit for BMW 1.6 petrol

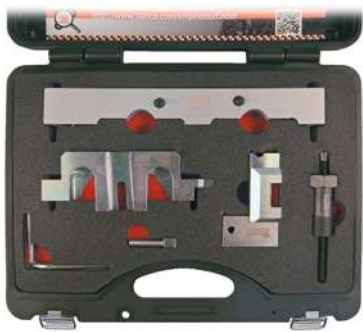

BE502102



270 x 95 x 355 mm



1 BE502102

BE50210103	
BE50210105	
BE50210107	
BE50210201	
BE50210202	
BE50210203	

Timing kit for BMW 2.0 - 2.5 - 3.0 diesel



BE502204



68 x 225 x 280 mm



1 BE502204

BE50220401	
BE50220403	
BE50220404	
BE50220405	
BE50210305	

Timing kit for BMW Mini 1.6-2.0 diesel



Timing kit for BMW 1.6-2.0 petrol

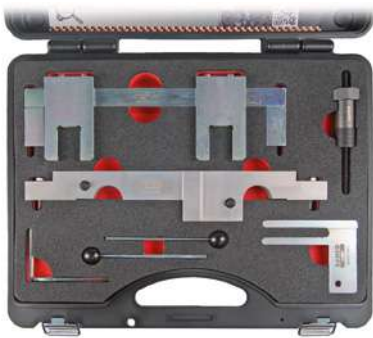

BE502103



80 x 300 x 375 mm



1 BE502103

BE50210301	
BE50210302	
BE50210303	
BE50210305	
BE50210105	
BE50210107	

BE503201



68 x 225 x 280 mm



1 BE503201

BE50320101	
BE50320102	
BE50320103	
BE50320105	
BE50210305	

Timing kit for MINI-PSA 1.4-1.6 petrol



BE504102



95 x 270 x 350 mm



1 BE504102

BE50410201	
BE50410202	
BE50410203	
BE50410204	
BE50410206	
BE50210105	

Timing kit for MINI-PSA 1.6 diesel



BE504201



50 x 50 x 220 mm



1 BE504201

BE50420101	
BE50420102	
BE50420103	
BE50420104	
BE50210305	



Timing kit for Ford 1.25-1.4-1.6 petrol



BE505101



68 x 225 x 280 mm

1 BE505101

BE50510101	
BE50510102	
BE50510103	
BE50510104	
BE50510105	
BE50510106	

Timing kit for Ford 1.0 EcoBoost petrol

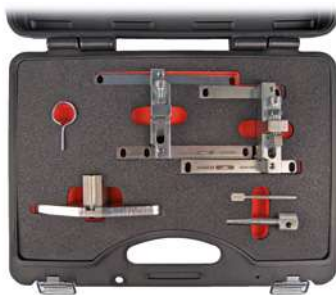

BE505102



95 x 270 x 350 mm

1 BE505102

BE50510201	
BE50510202	
BE50510203	
BE50510204	
BE50420102	
BE50510102	

Timing kit for Ford 2.0 - 2.2 - 2.4 Duratorq TDCI 16v diesel



BE505203



95 x 270 x 350 mm

1 BE505203

BE50520301	
BE50520302	
BE50520303	
BE50520304	
BE50520305	
BE50520306	
BE50520307	

Timing kit for Ford 1.4-1.6-1.8-2.0-2.2-2.5 diesel



BE505204



95 x 270 x 350 mm

1 BE505204

BE50520401	
BE50520402	
BE50520403	
BE50520404	
BE50520405	
BE50520407	
BE50520411	
BE50520412	
BE50520413	
BE50510104	
BE50420102	
BE50420103	
BE50420104	
BE50510106	

Timing kit for Opel 1.0-1.2-1.4 petrol



BE506101



50 x 50 x 160 mm

1 BE506101

BE50610101	
BE50610102	
BE50610103	
BE50610104	
BE50610105	

Timing kit for Opel 1.4-1.6-1.8 petrol



BE506102



68 x 225 x 280 mm

1 BE506102

BE50610201	
BE50610202	
BE50610203	
BE50610204	
BE50610205	
BE50610206	

Timing kit for Opel 1.0-1.2-1.4 Ecoflex petrol



BE506103



95 x 270 x 350 mm



1 BE506103

- BE50610302
- BE50610304
- BE50610102
- BE50610103
- BE50610105

Timing kit for Opel 2.0 diesel



BE506204



85 x 300 x 375 mm



1 BE506204

- BE50620401
- BE50620402
- BE50620403
- BE50620404
- BE50620405

Timing kit for PSA 1.0-1.1-1.4-1.6-1.8-2.0-2.2 petrol



BE507101



95 x 270 x 350 mm



1 BE507101

- BE50710103
- BE50710104
- BE50710105
- BE50710106
- BE50710107
- BE50710108
- BE50710109
- BE50710110
- BE50710111
- BE50710112
- BE50710101
- BE50710102
- BE50710113
- BE50710114
- BE50710116
- BE50710117
- BE50710118
- BE50710119
- BE50420104

Timing kit for PSA 1.0-1.2 petrol



BE507102



68 x 225 x 280 mm



1 BE507102

BE50710201



BE50710202



Timing kit for PSA 1.4-1.5-1.6-1.9-2.0-2.2-2.5 diesel



BE507203



85 x 300 x 375 mm



1 BE507203

- BE50720301
- BE50720302
- BE50720304
- BE50720305
- BE50720307
- BE50720308
- BE50720310
- BE50720312
- BE50720314
- BE50720317
- BE50720318
- BE50720319
- BE50720320
- BE50720321
- BE50720322
- BE50720323
- BE50520404
- BE50520411
- BE50710107
- BE50710104
- BE50710113
- BE50710110
- BE50710102
- BE50710106
- BE50420102
- BE50420103



Timing kit for Renault/Dacia 1.2-1.4-1.6-1.8-2.0 petrol

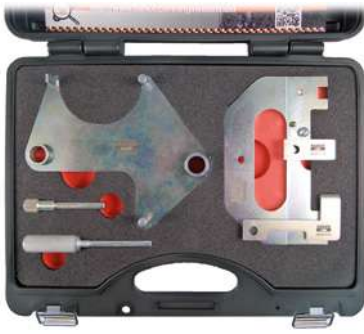

BE508101



95 x 270 x 350 mm



1 BE508101

BE50810101	
BE50810102	
BE50810103	
BE50810104	
BE50810105	
BE50810106	

Timing kit for Renault 1.5-1.9-2.2-2.5 diesel



BE508202



80 x 300 x 375 mm



1 BE508202

BE50820201	
BE50820202	
BE50820203	
BE50820204	
BE50820205	
BE50820206	
BE50820207	
BE50820208	
BE50820209	
BE50820211	
BE50810103	
BE50810104	

Timing kit for Renault 2.0 diesel



BE508203



68 x 225 x 280 mm



1 BE508203

BE50820301	
BE50820302	
BE50820303	
BE50820304	
BE50210305	

Timing set for Renault-Nissan 1.6 diesel



BE508204



95 x 270 x 350 mm



1 BE508204

BE50820402	
BE50820403	
BE50820404	
BE50820302	

Timing kit for VW Group 1.4-1.6-1.8-2.0 petrol



BE509101



80 x 300 x 375 mm



1 BE509101

BE50910101	
BE50910102	
BE50910103	
BE50910104	
BE50910105	
BE50910106	
BE50910107	
BE50910108	
BE50910109	
BE50910110	
BE50910111	
BE50910112	
BE50910114	
BE50520302	

Timing kit for VW Group 1.2-1.4-1.6 petrol



BE509102



68 x 225 x 280 mm



1 BE509102

BE50910201	
BE50910202	
BE50910203	
BE50910205	
BE50910206	
BE50910207	
BE50520302	

Timing kit for VW Group 1.2 TSI petrol



BE509103



50 x 50 x 210 mm

1 BE509103

BE50910302



BE50910203



Timing kit for VW Group 1.0 petrol



BE509104



68 x 225 x 280 mm

1 BE509104

BE50910401



BE50910402



BE50910403



BE50910404



BE50910203



Timing kit for VW Group 1.2-1.4-1.6-1.9-2.0 diesel



BE509205_1



60 x 60 x 220 mm

1 BE509205

BE50910103



BE50920602



BE50920603



Timing kit for VW Group 1.9-2.0 diesel



BE509206



60 x 60 x 220 mm

1 BE509206

BE50920602



BE50910103



BE50920703



Timing kit for VW Group 1.2-1.4-1.6-1.9-2.0 diesel



BE509207



95 x 270 x 350 mm

1 BE509207

BE50920703



BE50920707



BE50920708



BE50920709



BE50920710



BE50920711



BE50910103



BE50910112



BE50920602



BE50920603



BE50910109



BE50510102



Timing kit for Volvo 1.6 - 1.8 - 1.9 - 2.0 - 2.3 - 2.4 - 2.5 petrol



BE510101



60 x 60 x 355 mm

1 BE510101

BE51010101



BE51010102



BE51010103



Timing kit for Volvo 1.6 - 1.8 - 2.0 16v. petrol



BE510102

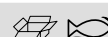

50 x 50 x 220 mm

1 BE510102

BE51010201



BE51010202



BE50510102



BE50510105



BE50510106



Timing kit for Volvo 1.6 - 2.0 diesel



BE510203



68 x 225 x 280 mm



1 BE510203

BE50420102	
BE50420103	
BE50420104	
BE50520407	
BE50520411	
BE50510104	

Crankshaft pulley holding tool for Volvo



BE510304



50 x 145 x 265 mm



1 BE510304

Timing kit for Saab 1.8i petrol



BE511101



50 x 50 x 220 mm



1 BE511101

BE51110101



BE51110102



BE50610201



BE50610204



Timing kit for Saab 1.6t petrol



BE511102



50 x 50 x 207 mm



1 BE511102

BE50610201



BE50610202



BE50610205



BE50610203



Timing kit for Saab 1.9 - 2.0 - 2.2 Tid diesel



BE511203



80 x 300 x 375 mm



1 BE511203

BE51120301



BE51120302



BE51120303



BE51120304



BE51120305



BE50120302



BE50120303



BE50120305



BE50610201



Universal set for removing broken glow plugs



BE513201



95 x 270 x 350 mm



2.10 kg



1 BE513201

BE51320101	
BE51320102	
BE51320103	
BE51320104	
BE51320105	
BE51320106	
BE51320107	
BE51320108	
BE51320109	
BE51320110	
BE51320111	
BE51320112	
BE51320113	
BE51320114	

Sprocket holding wrench universal



BE523106



410 mm



1 BE523106

Adjustable Universal Camshaft Locking Tool



BE5100



345 x 150 x 85 mm

1 BE5100

Stretch belt installer/remover



BE230



35 x 145 x 155 mm

1 BE230

Alternator extractor 24 pcs set



BE500P24



55 x 270 x 370 mm

5 BE500P24
1 BE500P2401
1 BE500P2402
1 BE500P2403
1 BE500P2404
1 BE500P2405
1 BE500P2406
1 BE500P2407
1 BE500P2408



1 BE500P2409
1 BE500P2410
1 BE500P2411
1 BE500P2412
1 BE500P2413
1 BE500P2414
1 BE500P2415
1 BE500P2416
1 BE500P2417
1 BE500P2418
1 BE500P2419
1 BE500P2420
1 BE500P2421
1 BE500P2422
1 BE500P2423
1 BE500P2424

Diesel compression tester



BE5401D



105 x 325 x 410 mm

1 BE5401D

Digital petrol engine compressor tester



BE5400P



70 x 160 x 260 mm

1 BE5400P

Belt tension tester



BE239



38 x 82 x 95 mm 95 mm

1 BE239

Electronic belt tension tester



BE240



60 x 270 x 315 mm 315 mm

1 BE240

Data book of tension values for timing and accessory belts, synchronous, V&V and ribbed shape.



BE240-CAT



710 g

1 BE240-CAT



Laser thermometer



BLT550

-50 +550 °C
 40 x 95 x 145 mm
 10
 BLT550

Quick fluid stopper and injector hose separator set



BE257

68 x 225 x 280 mm
 8 BE257
 1 BE25710
 1 BE25718
 1 BE2572
 1 BE2576

Universal injector removal tool kit



BE512201

140 x 415 x 600 mm
 1
 BE512201

BE51220101	
BE51220102	
BE51220103	
BE51220104	
BE51220105	
BE51220106	
BE51220107	
BE51220108	
BE51220109	
BE51220110	
BE51220111	
BE51220112	
BE51220113	
BE51220114	
BE51220115	
BE51220116	
BE51220117	
BE51220118	
BE51220119	
BE51220120	

Injector puller set



BE1311P13

80 x 355 x 445 mm
 1
 BE1311P13

Injection nozzle socket set; 25, 27, 29 & 30 mm



BE1310P4

68 x 225 x 225 mm
 1
 BE1310P4

1/2" impact socket for removing Bosch and Siemens injection nozzles



BE1310P425-BE1310P430

25 mm	1/2 in	1	BE1310P425
27 mm	1/2 in	1	BE1310P427
29 mm	1/2 in	1	BE1310P429
30 mm	1/2 in	1	BE1310P430

Diesel injector seat cleaner set



BE1320S17

76 x 266 x 355 mm
 10
 BE1320S17

Diesel injector seat cutter



BE1315P7



68 x 225 x 280 mm	1	BE1315P7
25 x 180 x 275 mm	1	BE1315P71
20 x 93 x 175 mm	1	BE1315P72
19 x 93 x 140 mm	1	BE1315P73
16 x 93 x 140 mm	1	BE1315P74
20 x 56 x 96 mm	1	BE1315P75
20 x 56 x 96 mm	1	BE1315P76
23 x 56 x 96 mm	1	BE1315P77

Slide hammer / Washer and wiper puller



BE1300SH



235 mm	50 x 50 x 235 mm	10	BE1300SH
--------	------------------	----	----------

Special Internal Valve Seat Removal Tool for Denso Common Rail Injectors



BE1312DNS



12	BE1312DNS
----	-----------

Diesel injector washer puller



BE1300



230 mm	35 x 35 x 260 mm	1	BE1300
--------	------------------	---	--------

Valve lapper set



BE762



30 x 90 x 315 mm	68 g	12	BE762
------------------	------	----	-------

Valve spring compressor removal tools



BE76101



40 x 200 x 290 mm	1	BE76101
-------------------	---	---------

Copper injector sealing ring set



BE1305P450



40 x 140 x 205 mm	1	BE1305P450
-------------------	---	------------

Sets of 30 washers for injectors

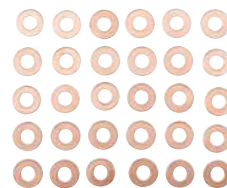

BE1305P450B



1	BE1305P450WS01
1	BE1305P450WS02
1	BE1305P450WS03
1	BE1305P450WS04
1	BE1305P450WS05
1	BE1305P450WS06
1	BE1305P450WS07
1	BE1305P450WS08
1	BE1305P450WS09
1	BE1305P450WS10
1	BE1305P450WS11
1	BE1305P450WS12
1	BE1305P450WS13
1	BE1305P450WS14
1	BE1305P450WS15

Common rail 8 injectors fuel return tester



BE5350



84 x 341 x 447 mm	5	BE5350
10 x 56 x 96 mm	1	BE5350C1
10 x 56 x 96 mm	1	BE5350C2
10 x 56 x 96 mm	1	BE5350C3
10 x 56 x 96 mm	1	BE5350C4
115 x 65 x 205 mm	1	BE5350C5



Diesel injector tester



BE13ZL11

480 x 230 x 280 mm 4.24 kg 1 BE13ZL11

Tamper Torx® Bit/Socket Set, 1/4"



BE5008

40 x 20 x 175 mm 1 BE5008

BE5008-45, BE5008-27, BE5008-25,
BE5008-40, BE5008-30, BE5008-10,
BE5008-20, BE5008-15

Tamper Torx socket



BE5008-10/BE5008-45

10	1	BE5008-10
15	1	BE5008-15
20	1	BE5008-20
25	1	BE5008-25
27	1	BE5008-27
30	1	BE5008-30
40	1	BE5008-40
45	1	BE5008-45

Glow plug socket set



BE1GP5

1/4 in 110 x 240 x 40 mm 1 BE1GP5

BE1GP514, BE1GP510, BE1GP512,
BE1GP58, BE1GP59

Glow plug puller



BE1205

130 mm 35 x 35 x 130 mm 1 BE1205

Sets of 5 inserts/coils for repairing/
restoring damaged glow plug threads



BE1210P110x

M8x1	50 g	1	BE1210P1101
M10x1	50 g	1	BE1210P1102
M10x1,25	50 g	1	BE1210P1103

Glow plug chamber cleaning set



BE1200P6

50 x 115 x 260 mm 1 BE1200P6

Reamer for BE1200P6



BE1200P6AC1

50 x 158 x 192 mm 1 BE1200P6AC1

T-handle for glow plug sockets



BE1GP5-T

1/4 in 400 mm 10 BE1GP5-T

Glow plug flex sockets



BE1GP58/BE1GP514



Ø	L	Icon	Part No.
8 mm	70 mm		1 BE1GP58
9 mm	70 mm		1 BE1GP59
10 mm	70 mm		1 BE1GP510
12 mm	70 mm		1 BE1GP512
14 mm	70 mm		1 BE1GP514

Spark Plug Articulated Extension Tool



BE1SP1F



Icon	Dimensions	Quantity	Part No.
	30 mm	21	BE1SP1F

3/8" Square Drive Spark Plug Sockets



7402GPR



Ø	Quantity	Part No.
16 mm	120	7402GPR-16
18 mm	120	7402GPR-18
21 mm	100	7402GPR-21

Glow plug thread repair set



BE1210P11

Icon	Dimensions	Quantity	Part No.
	50 x 120 x 260 mm	1	BE1210P11
	112 x 13 x 95 mm	1	BE1210P9AC1

Spark plug sockets with magnet, 3/8"



7406ZZ



Ø	L	Quantity	Part No.
16 mm	65 mm	1	7406ZZ-16
21 mm	64 mm	1	7406ZZ-21

Spark plug wrench



BE1SP



Ø	L	Quantity	Part No.
3/8 in	252 mm	10	BE1SP16L
3/8 in	252 mm	1	BE1SP14L

Spark Plug Pliers



BE1P

Icon	Dimensions	Quantity	Part No.
	290 mm	1	BE1P

1/2" Square Drive Spark Plug Sockets



7805GPR



Ø	L	Quantity	Part No.
16 mm	64 mm	120	7805GPR-16
21 mm	64 mm	100	7805GPR-21

Spark plug wrenches



BE1T14/BE1T16/BE1T21



Ø	L	Quantity	Part No.
14 mm	65/310 mm	1	BE1T14
16 mm	63/450 mm	1	BE1T16
21 mm	67/450 mm	1	BE1T21



BE110014 / Tap: M14x1.25P



BE110014/BE110015

55 g	1	BE110014
55 g	1	BE110015

Insert coils for repairing spark plug threads



BE1100AC1/BE1100AC2

9.4 mm	1	BE1100AC1
15 mm	1	BE1100AC2

Ribe 1/2" socket with bit, suitable for engines



BE5102

65 x 225 x 225 mm	1	BE5102

BE51026, BE51025, BE510210,
BE510211, BE510212, BE510213,
BE51027, BE51028, BE51029

1/2" socket drivers with Ribe bits



BE51025-BE510213

RM5	100 mm	1	BE51025
RM6	100 mm	1	BE51026
RM7	100 mm	1	BE51027
RM8	100 mm	1	BE51028
RM9	100 mm	1	BE51029
RM10	100 mm	1	BE510210
RM11	100 mm	1	BE510211
RM12	100 mm	1	BE510212
RM13	100 mm	1	BE510213

XZN 1/2" socket with bit, suitable for engines



BE5103

65 x 225 x 225 mm	1	BE5103

BE51036, BE51038, BE510310,
BE510312, BE51035, BE510314

1/2" socket drivers with XZN bits



BE51035-BE510314

M5	140 mm	1	BE51035
M6	140 mm	1	BE51036
M8	140 mm	1	BE51038
M10	140 mm	1	BE510310
M12	140 mm	1	BE510312
M14	140 mm	1	BE510314

Spark plug wire brush



52

150 mm	12	52

General purpose utility wire brush



782-U

285 mm	1	782-U

Terminal brush



2555

85 mm	1	2555

Spark plug thread restorer set



BE1100

68 x 225 x 280 mm
 1.55 kg
 8 BE1100

Milling cutter



BE110001

60 g
 1 BE110001

Piston Ring Tongs



BE74-55100/BE74-80120

55-100 mm 20 x 130 x 205 mm 1 BE74-55100

 80-120 mm 20 x 145 x 220 mm 1 BE74-80120

Piston ring tightener



BE74-57125/BE74-90175

80 mm	57-125 mm	1 BE74-57125
165 mm	90-175 mm	1 BE74-90175
80 mm	57-125 mm	1 BE74-57125L

Refractometer



3046-REF

150 mm
 1 3046-REF

Antifreeze liquid tester



BE401

50 x 50 x 235 mm 235 mm 1 BE401

Cooling system pressure tester set



BE400P24

127 x 435 x 510 mm
 1 BE400P24

Radiator pressure pump with gauge for testing cooling or heating systems



BE400P241

BAR PSI

 0-2,5 bar 0-36 psi 1 BE400P241

Radiator cap test connector R124/R123



BE400P242

0.035 kg

 1 BE400P242



Radiator cap test connector R123/R125



BE400P243

0.06 kg	1	BE400P243

Radiator cap tester for cooling system



BE400P2402

65 mm	1	BE400P2402

Adaptor for testing the cooling system



BE400P2405

0.065 kg	1	BE400P2405

Thermometer 0-200°C



BE400P244

0.02 kg	1	BE400P244

Radiator cap tester for cooling system



BE400P2403

43.5 mm	1	BE400P2403

Adaptor for testing the cooling system



BE400P2406

0.065 kg	1	BE400P2406

Radiator cap tester for cooling system



BE400P2401

65 mm	1	BE400P2401

Adaptor for testing the cooling system



BE400P2404

0.055 kg	1	BE400P2404

Adaptor for testing the cooling system



BE400P2407

0.065 kg	1	BE400P2407

Adaptor for testing the cooling system



BE400P2408



0.075 kg



1 BE400P2408

Adaptor for testing the cooling system



BE400P2411



0.11 kg



1 BE400P2411

Adaptor for testing the cooling system



BE400P2414



0.11 kg



1 BE400P2414

Adaptor for testing the cooling system



BE400P2409



0.11 kg



1 BE400P2409

Adaptor for testing the cooling system



BE400P2412



0.085 kg



1 BE400P2412

Adaptor for testing the cooling system



BE400P2415



0.075 kg



1 BE400P2415

Adaptor for testing the cooling system



BE400P2410



0.085 kg



1 BE400P2410

Adaptor for testing the cooling system



BE400P2413



0.065 kg



1 BE400P2413

Adaptor for testing the cooling system



BE400P2416



0.065 kg



1 BE400P2416



Adaptor for testing the cooling system



BE400P2417



0.11 kg

1 BE400P2417

Adaptor for testing the cooling system



BE400P2418



0.045 kg

1 BE400P2418

Adaptor for testing the cooling system



BE400P2419



0.075 kg

1 BE400P2419

Plastic wrench for radiator cap



BE400P2420



0.005 kg

1 BE400P2420

Cooling system purging and filling set



BE410



80 x 300 x 375 mm
45 x 45 x 105 mm

4 BE410
1 BE4101

Gasket joints separator set



BE700



90 x 200 x 43 mm

1 BE700
1 BE700BP2
1 BE700SP15

10 mm bit set



BE5032



65 x 225 x 225 mm

1 BE5032

BE5049M5, BE5049M6, BE5049M8,
BE5049M10, BE5049M12, BE5032M14



BE5049T20, BE5049T25, BE5049T27,
BE5049T30, BE5049T40, BE5049T45,
BE5049T50, BE5049T55, BE5049T60



BE5049H5, BE5049H6, BE5049H8,
BE5049H10, BE5049H12, BE5032H14



BE5032SQ8, BE5032SQ10



BE5049H6L, BE5049H8L, BE-
5032H10EL



BE5049T45L, BE5032T55EL



BE5049M8L, BE5049M10L,
BE5049M12L



BE504901



Bit for Robertson Metric Head Screws, 10 mm



BE5032SQ



#8 mm 30 mm
#10 mm 30 mm

1 BE5032SQ8
1 BE5032SQ10

1/2" socket drivers with Tamper Torx bits





BE510125-BE510160



TR25 100 mm
TR27 100 mm
TR30 100 mm



1 BE510125
1 BE510127
1 BE510130

			
TR40	100 mm	1	BE510140
TR45	100 mm	1	BE510145
TR50	100 mm	1	BE510150
TR55	100 mm	1	BE510155
TR60	100 mm	1	BE510160

Crankshaft and camshaft seal installation set 





BE5150P27

		
80 x 270 x 375 mm	1	BE5150P27
56 x 56 x 96 mm	1	BE5150P271
80 x 80 x 195 mm	1	BE5150P272
170 x 160 x 385 mm	1	BE5150P273

A/C repair tool set 





BE800P12

		
43 x 90 x 200 mm	1	BE800P12

Adaptor set for disconnection of A/C hoses 





BAC007

			
240 mm	0.075 kg	1	BAC007

Engine support bar 



BH8AC1-500

			
150 x 165 x 1800 mm	20.71 kg	1	BH8AC1-500

500 kg geared engine stand 



BH8AC2-500

		
500 kg	1	BH8AC2-500

Angle hose clamp pliers 45° 





BE250

			
190 mm	245 g	1	BE250

Hose clamp pliers 



BE251A

			
30 x 55 x 220 mm	228 g	12	BE251A

EGR type hose clamp pliers 



BE253

		
870 mm	1	BE253



Standard Space Saver & Hose Clamp Ratcheting Tool



BE254A

18-53 mm		1	BE254A

Cable

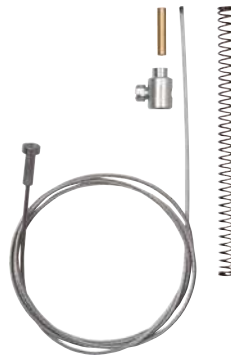

BE2542

630 mm	20 g	1	BE2542

Oetiker™ Clamp Pliers



BPOC15

275 mm	12	BPOC15

Spare Cable for BE254A Pliers



BE254A-01

590 mm	130 g	1	BE254A-01

Hose clamp metallic



BE256M

40 x 45 x 310 mm	1	BE256M

Hose clamp pliers set



BE256P3

40 x 93 x 330 mm 15 x 55 x 155 mm 20 x 45 x 185 mm 10 x 55 x 250 mm	1	BE256P3 BE256-155 BE256-178 BE256-250

Repair kit for BE254



BE2541

100 g	1	BE2541

Elastic hose clamp pliers



BE258

12-55 mm	285 mm	1	BE258

Slotted socket set



BE5500

10/11/12/14/17/19	25	BE5500

Slotted Sockets



BE5500-10/BE-5500-19

3/8 in	10	1	BE550010
3/8 in	11	1	BE550011
3/8 in	12	1	BE550012
3/8 in	14	1	BE550014
1/2 in	17	1	BE550017
1/2 in	19	1	BE550019

Fuel line disconnecting pliers



BE1FLD1/BE1FLD3

10 mm	1	BE1FLD1
8 mm	1	BE1FLD2
18.5 mm	1	BE1FLD3

Seal and soft hose removal and picking tool set



2633HD/S6

80 x 270 x 375 mm	1 2633HD/S6
42 x 93 x 290 mm	1 2633HD1
30 x 85 x 215 mm	1 2633HD2
30 x 93 x 200 mm	1 2633HD3
20 x 87 x 165 mm	1 2633HD4
10 x 60 x 120 mm	1 2633HD5
10 x 10 x 155 mm	1 2633HD6

In-Line Fuel Filter Connection Pliers



BE6FCP

104 mm	218 mm	30	BE6FCP

Fuel gauge puller



BE1FTW

75-160 mm	1	BE1FTW

T-Handle Set with Hex Metric Tips - 5 pcs



BE1TH-S5

5	1	BE1TH-S5

Fuel line disconnecting pliers set



BE1FLDS

8-10 mm	1	BE1FLDS

Fuel Filter Wrench Ford 2.2TDCi



BE1FFWF

5 x 142 x 169 mm	12	BE1FFWF

Set of 6 T-Bar Handles for Allen Hex Socket Head Screws 2.5, 3, 4, 5, 6 & 8 mm



BE1TH-S6

6	30	BE1TH-S6

BE1FLD2, BE1FLD3, BE1FLD1



BE1TH-4, BE1TH-8, BE1TH-2.5, BE1TH-3, BE1TH-6, BE1TH-5



T-bar handle for Allen - Hexagonal head screws



BE1TH

mm	g	Icons	Part No.
10 mm	385 g	5	BE1TH-10
12 mm	571 g	5	BE1TH-12
2 mm	15 g	10	BE1TH-2
2.5 mm	20 g	10	BE1TH-2.5
3 mm	23 g	10	BE1TH-3
3.5 mm	23 g	10	BE1TH-3.5
4 mm	60 g	10	BE1TH-4
4.5 mm	60 g	10	BE1TH-4.5
5 mm	60 g	10	BE1TH-5
6 mm	127 g	10	BE1TH-6
7 mm	205 g	10	BE1TH-7
8 mm	205 g	10	BE1TH-8
9 mm	385 g	10	BE1TH-9

T-bar handle with swivel socket 500 mm long



BE1TS

mm	g	Icons	Part No.
10 mm	485 g	10	BE1TS-10
11 mm	485 g	10	BE1TS-11
12 mm	475 g	10	BE1TS-12
13 mm	485 g	10	BE1TS-13
14 mm	485 g	10	BE1TS-14
15 mm	485 g	10	BE1TS-15
16 mm	495 g	10	BE1TS-16
17 mm	495 g	10	BE1TS-17
18 mm	510 g	10	BE1TS-18
19 mm	495 g	10	BE1TS-19
20 mm	730 g	8	BE1TS-20
21 mm	765 g	8	BE1TS-21
22 mm	745 g	8	BE1TS-22
24 mm	745 g	8	BE1TS-24
6 mm	475 g	10	BE1TS-6
7 mm	475 g	10	BE1TS-7
8 mm	485 g	10	BE1TS-8
9 mm	475 g	10	BE1TS-9

Set of 7 T-Bar Handles with Swivel Sockets 7, 8, 10, 12, 13, 14 & 17 mm 500 mm long



BE1TS-S7

7	1	BE1TS-S7
---	---	----------

BE1TS-17, BE1TS-13, BE1TS-14, BE1TS-12, BE1TS-7, BE1TS-8, BE1TS-10

T handle bar with rotating aluminium holder



1945W

mm	mm	Icons	Part No.
1/2 in	311 mm	6	1945W12
1/4 in	311 mm	8	1945W14
3/8 in	311 mm	6	1945W38

Bit set 49 pcs with Torx tamper bits



BE5049

55 x 190 x 320 mm	3.56 kg	5	BE5049
-------------------	---------	---	--------

1/2" adaptor for 10 mm bits



BE504901

10 mm	36 mm	1	BE504901
-------	-------	---	----------

Bit for Hexagon Metric Head Screws, 10 mm



BE5049H

mm	mm	Icons	Part No.
4 mm	30 mm	1	BE5049H4
5 mm	30 mm	1	BE5049H5
6 mm	30 mm	1	BE5049H6
7 mm	30 mm	1	BE5049H7
8 mm	30 mm	1	BE5049H8
10 mm	30 mm	1	BE5049H10
12 mm	30 mm	1	BE5049H12
14 mm	30 mm	1	BE5032H14

Bit for XZN Head Screws, 10 mm



BE5049M

	L		
M5	30 mm	1	BE5049M5
M6	30 mm	1	BE5049M6
M8	30 mm	1	BE5049M8
M10	30 mm	1	BE5049M10
M12	30 mm	1	BE5049M12
M14	30 mm	1	BE5032M14

Bit for Torx® Head Screws, 10 mm



BE5049T

	L		
T20	30 mm	1	BE5049T20
T25	30 mm	1	BE5049T25
T27	30 mm	1	BE5049T27
T30	30 mm	1	BE5049T30
T40	30 mm	1	BE5049T40
T45	30 mm	1	BE5049T45
T50	30 mm	1	BE5049T50
T55	30 mm	1	BE5049T55
T60	30 mm	1	BE5049T60

Bit for Torx® Tamper Head Screws, 10 mm



BE5049T_H

	L		
TR20	30 mm	1	BE5049T20H
TR25	30 mm	1	BE5049T25H
TR27	30 mm	1	BE5049T27H
TR30	30 mm	1	BE5049T30H
TR40	30 mm	1	BE5049T40H
TR45	30 mm	1	BE5049T45H
TR50	30 mm	1	BE5049T50H

	L		
TR55	30 mm	1	BE5049T55H
TR60	30 mm	1	BE5049T60H

Torx® Tamper 1/2" socket with bit, suitable for engines



BE5101

65 x 225 x 225 mm		1	BE5101

BE510150, BE510145, BE510160, BE510155, BE510127, BE510125, BE510140, BE510130

Engine oil pressure tester set



BE5200

85 x 355 x 445 mm		1	BE5200
25 x 105 x 195 mm		1	BE530001
		1	BE52001
		1	BE52002
		1	BE52003

3/8" adaptor for 10 mm bits



BE504902

	L		
10 mm	28 mm	1	BE504902

Bit for Hexagon Metric Head Screws, 10 mm



BE5049H_L

	L		
4 mm	75 mm	1	BE5049H4L
5 mm	75 mm	1	BE5049H5L
6 mm	75 mm	1	BE5049H6L
7 mm	75 mm	1	BE5049H7L
8 mm	75 mm	1	BE5049H8L
10 mm	75 mm	1	BE5049H10L
10 mm	115 mm	1	BE5032H10EL
12 mm	75 mm	1	BE5049H12L

Bit for XZN Head Screws, 10 mm



BE5049M_L

	L		
M5	75 mm	1	BE5049M5L
M6	75 mm	1	BE5049M6L
M8	75 mm	1	BE5049M8L
M10	75 mm	1	BE5049M10L
M12	75 mm	1	BE5049M12L



Bit set 49 pcs with regular Torx bits



BE5049t

55 x 190 x 320 mm	3.54 kg	1	BE5049T

Bit for Torx® Tamper Head Screws, 10 mm

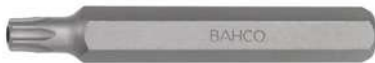

BE5049T_HL

TR20	75 mm	1	BE5049T20HL
TR25	75 mm	1	BE5049T25HL
TR27	75 mm	1	BE5049T27HL
TR30	75 mm	1	BE5049T30HL
TR40	75 mm	1	BE5049T40HL
TR45	75 mm	1	BE5049T45HL
TR50	75 mm	1	BE5049T50HL
TR55	75 mm	1	BE5049T55HL
TR60	75 mm	1	BE5049T60HL
TR70	100 mm	1	BE5049T70HL
TR80	70 mm	1	BE5049T80HL
TR30	200 mm	1	BE5049T30HXL
TR40	200 mm	1	BE5049T40HXL
TR45	200 mm	1	BE5049T45HXL

Bit for Torx® Head Screws, 10 mm

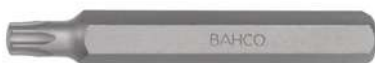

BE5049T_L

T20	75 mm	1	BE5049T20L
T25	75 mm	1	BE5049T25L
T27	75 mm	1	BE5049T27L
T30	75 mm	1	BE5049T30L

T40	75 mm	1	BE5049T40L
T45	75 mm	1	BE5049T45L
T50	75 mm	1	BE5049T50L
T55	75 mm	1	BE5049T55L
T55	115 mm	1	BE5032T55EL

EXHAUST TOOLS

Exhaust Fume Extractor



BUCPE

5000 mm	1263 x 306 x 300 mm	1	BUCPE
105 mm	15 x 105 x 105 mm	1	BUCPEF1
121 mm	60 x 121 x 121 mm	1	BUCPEF

Tube extension for BUCPE



BUCPE3SH

3000 mm	63,5 mm	1	BUCPE3SH

A dual exhaust pipe for BUCPE



BUCPE3SDH

420 x 530 x 3000 mm	3000 mm	1	BUCPE3SDH

1/2" Lambda service socket



7812

22 mm	78 mm	100	7812

Exhaust clamp pliers



BUC50

65 mm	305 mm	1	BUC50

Universal exhaust removal tool



BUC110

360 mm	50 x 65 x 360 mm	1	BUC110

Oil & Fuel Filter Remover



BE60FW

57-120 mm	18 x 95 x 325 mm	5	BE60FW

Oil filter chain wrench



BE64520/BE64350

350 mm	60-105 mm	1	BE64350
350 mm	60-105 mm	1	BE64350CH
520 mm	60-160 mm	1	BE64520
520 mm	60-160 mm	1	BE64520CH

Universal exhaust puller



BUC100

34-54 mm	320 mm	1	BUC100

Oil filter strap wrench



BE611

65-105 mm	25 x 55 x 210 mm	12	BE61110
65-105 mm	1 x 12 x 382 mm	100	BE61110-1
100-155 mm	37 x 75 x 275 mm	12	BE61155
100-155 mm	1 x 12 x 529 mm	1	BE61155-1

Rubber belt wrench



BE66152A

150 mm	95 x 170 x 220 mm	6	BE66152A

OIL SERVICE TOOLS & EQUIPMENT

Fuel Filter Cover Wrench



BE60F108

3/8 in	108 mm	50	BE60F108

Oil filter strap wrench with rubber handle



BE62

65-105 mm	42.5 x 57 x 249 mm	10	BE62110
110-155 mm	42.5 x 85 x 314 mm	10	BE62155

3-jaw oil filter wrench



BE65F65120

3/8 in	65-120 mm	12	BE65F65120



Magnetic 3-jaw oil filter wrenches



BE65R

Icon 1	Icon 2	Icon 3	Icon 4
3/8-1/2 in	65-120 mm	1	BE65R65120
3/8-1/2 in	80-119 mm	1	BE65R80120
1/2 in	105-160 mm	1	BE65R106160

Oil filter cup set



BE630

Icon 1	Icon 2	Icon 3	Icon 4
87 x 505 x 610 mm		3	BE630

Individual filter cups



BE630 Parts

Icon 1	Icon 2	Icon 3	Icon 4
66 mm	Fiat, Renault	1	BE630666F
64 mm	Daihatsu, Fiat, Nissan, Toyota	12	BE6306514F
65-66 mm	Daihatsu, Toyota	12	BE630656714F
66 mm	Ford, Mazda, Subaru	1	BE6306814F

Icon 1	Icon 2	Icon 3	Icon 4
73 mm	Alfa Romeo, Lexus, Toyota	1	BE6307314F
74 mm	Audi, Chrysler, GM, Rover	1	BE6307415F
74-76 mm	Audi, Ford, Mercedes Benz, Opel, VW	12	BE630747615F
74-75 mm	Audi, Ford, Isuzu, Mercedes Benz, Opel, VW	1	BE630757715F
76 mm	Fiat, Mercedes Benz, Renault	12	BE6307612F
74 mm	Audi, BMW, Mercedes Benz, Opel, Porsche, VW	12	BE6307614F
74 mm	Ford	1	BE6307630F
74 mm	Fiat, Lancia	1	BE630768F
78 mm	Ford, Honda, Nissan, Toyota	12	BE6307815F
80 mm	Honda, Isuzu, Mazda, Nissan, Opel, Subaru, Toyota	1	BE6308015F
80-82 mm	Acura, Honda, Mazda, Nissan, Subaru, Toyota	1	BE630808215F
86 mm	Volvo	1	BE6308616F
86 mm	Audi, Citroen, Peugeot, Renault, VW	1	BE6308618F
89 mm	Honda, Isuzu, Mitsubishi	12	BE6309015F
92 mm	Fiat, Lancia	1	BE6309210F
92 mm	Audi, Ford, Honda, Mazda, Mitsubishi, Nissan, Opel, Porsche, Renault, Volvo, VW	1	BE6309315F
93 mm	Ford	1	BE6309336F
93 mm	Audi, VW	1	BE6309345F
95 mm	Alfa Romeo, Chrysler, Ford, Toyota	1	BE6309515F
96 mm	Audi, Renault, VW	1	BE6309618F
101 mm	Isuzu, Mitsubishi	25	BE63010015F
24 mm	BMW	50	BE630246F
106 mm	Fiat, MAN, Scania	1	BE63010615F
27 mm	Mercedes Benz	50	BE630276F
107 mm	Volvo	1	BE63010815F
32 mm	GM, Mercedes Benz, Opel, Saab	50	BE630326F
108 mm	Renault	1	BE63010818F
36 mm	BMW, Ford, Mercedes Benz, Opel, Rover, VW	100	BE630366F
38 mm	BMW, Opel, Volvo	50	BE630386F
66.5 mm	Daihatsu, Toyota	25	BE63066514F

27 mm oil filter wrench for Ford and PSA Group



BE6302712F

Icon 1	Icon 2	Icon 3	Icon 4
1/2 in	27 mm	5	BE6302712F

Oil Filter Wrench Toyota, Lexus, Subaru, Daihatsu with 4 Cylinders (1.8 to 2.0 litre)



BE63064514F1

Icon 1	Icon 2	Icon 3	Icon 4
Toyota, Lexus, Subaru, Daihatsu 4 cylinders (1.8-2.0l)	64.5 mm	1	BE63064514F1

Oil Filter Wrench Toyota, Lexus, Subaru, Daihatsu with 4, 6 or 8 Cylinders (2.5 to 5.7 litre)



BE63064514F2

Icon 1	Icon 2	Icon 3	Icon 4
64.5 mm	Toyota, Lexus, Subaru, Daihatsu 4, 6, 8 cylinders (2.5-5.7L)	1	BE63064514F2

Oil Filter Cup 74 mm 14 Flutes



BE6307414F



14 1 10 BE6307414F

Carter wrenches



BE68



8 in	265 mm	12	BE6810Z
8 in	235 mm	1	BE68
8 x 10 mm	270 mm	1	BE6810

1/4" Oil sump plug removal bit for VAG engine 2 litre 4 cylinders



BE6701VAG



10 x 50 x 125 mm 0.02 kg 1 BE6701VAG

Oil drain plug socket set



BE6217



55 x 105 x 220 mm 1 BE6217

3/8" Oil Plug Socket



BE621701-BE621717



#	mm		
6	8 mm	1	BE621701
6	9 mm	1	BE621702
6	10 mm	1	BE621703
6	12 mm	1	BE621704
6	13 mm	1	BE621705
6	14 mm	1	BE621706
6	17 mm	1	BE621707
4	8 mm	1	BE621708
4	9.5 mm	1	BE621709
4	10 mm	1	BE621710
4	10.5 mm	1	BE621711
4	11 mm	1	BE621712
4	12 mm	1	BE621713
4	13.1 mm	1	BE621714
4	10 mm	1	BE621715
3	10 mm	1	BE621716
xZN	M16 mm	1	BE621717

Oil drain plug restorer set



BOD10P64



68 x 225 x 280 mm 8 BOD10P64

Mini oil drain plug restorer sets



BOD10



34 x 93 x 105 mm	1	BOD101
35 x 95 x 105 mm	1	BOD102
33 x 93 x 105 mm	1	BOD103
33 x 93 x 105 mm	1	BOD104
33 x 93 x 105 mm	1	BOD105
95 x 105 x 35 mm	1	BOD106

Oil drain plug and washer set



BOD10XNWS



M13x1.25	1	BOD101NWS
M13x1.5	1	BOD102NWS
M15x1.5	1	BOD103NWS
M17x1.5	1	BOD104NWS
M20x1.5	1	BOD105NWS
M22x1.5	1	BOD106NWS



2 in 1 oil drainer with tank capacity 90L and inspection chamber



BOD8903A



1700 x 419 x 608 mm



1 BOD8903A

2 in 1 oil drainer with tank capacity 90L



BOD8902



1000 x 413 x 632 mm



38 kg



1 BOD8902

Gravity oil drainer with tank capacity 90L



BOD8901



1000 x 413 x 630 mm



32 kg



1 BOD8901

Extension funnel for oil drainers



BOD8901AC1



620 x 620 x 150 mm



1 BOD8901AC1

Automatic transmission fluid refiller



BOD6080P12



595 x 255 x 330 mm



1 BOD6080P12

Adaptor for BOD6080P12 set



BOD6080P12-01



35 g



1 BOD6080P12-01

Adaptor for BOD6080P12 set



BOD6080P12-02



55 g



1 BOD6080P12-02

Adaptor for BOD6080P12 set



BOD6080P12-03



45 g



1 BOD6080P12-03

Adaptor for BOD6080P12 set



BOD6080P12-04



6 g



1 BOD6080P12-04

Adaptor for BOD6080P12 set



BOD6080P12-05

25 g	1	BOD6080P12-05

Adaptor for BOD6080P12 set



BOD6080P12-09

15 g	1	BOD6080P12-09

Oil funnel



BOD301200

225 x 165 x 165 mm	1 BOD301200

Adaptor for BOD6080P12 set



BOD6080P12-06

25 g	1	BOD6080P12-06

Adaptor for BOD6080P12 set



BOD6080P12-10

85 g	1	BOD6080P12-10

Oil drain tank



BOD2008

8 l	115 x 325 x 590 mm	1 BOD2008

Adaptor for BOD6080P12 set



BOD6080P12-07

45 g	1	BOD6080P12-07

Adaptor for BOD6080P12 set



BOD6080P12-11

105 g	1	BOD6080P12-11

Adaptor for BOD6080P12 set



BOD6080P12-08

45 g	1	BOD6080P12-08

Oil cans



BOD4200/BOD4500

0.2l	158 x 86 x 128 mm	1 BOD4200
0.5l	158 x 86 x 128 mm	1 BOD4500

Oil drain pan



BOD1016

16l	170 x 450 x 570 mm	1 BOD1016



For tapping damaged oil plug thread slightly oversize, then fitting a new drain plug and washer



BOD10XT

Length (mm)	Thread	Quantity	Part No.
92 mm	M13x1.25	1	BOD101T
70 mm	M13x1.5	1	BOD102T
70 mm	M15x1.5	1	BOD103T
70 mm	M17x1.5	1	BOD104T
70 mm	M20x1.5	1	BOD105T
70 mm	M22x1.5	1	BOD106T

Lever Action Barrel Pump



BOD60

875 x 57 x 245 mm	1	BOD60
-------------------	---	-------

Grease flex hoses



BOD54-1 / -2

Inner Diameter (mm)	Outer Diameter (mm)	Quantity	Part No.
4.1 mm	10.8 mm	1	BOD54-1
4.1 mm	10.8 mm	1	BOD54-2

2L Can with Flexible Spout



BOD2FS

21	330 x 130 x 380 mm	20	BOD2FS
----	--------------------	----	--------

Heavy duty cartridge grease pump



BOD5HD400

60 x 115 x 360 mm	1	BOD5HD400
-------------------	---	-----------

Grease coupler



BOD54-3

37 mm	1	BOD54-3
-------	---	---------

Rotary barrel pump



BOD70

230 x 250 x 1330 mm	1	BOD70
---------------------	---	-------

Cartridge grease pump



BOD5400/BOD5450

55 x 120 x 390 mm	1	BOD5400
65 x 125 x 385 mm	1	BOD5450

BRAKE SYSTEM TOOLS & EQUIPMENT

Brake fluid tester pen



BBR100

20 x 20 x 150 mm	1	BBR100
------------------	---	--------

Brake fluid tester moisture check



BBR110



35 x 65 x 160 mm

1 BBR110

Brake Nipple Spanners



BBR501011-BBR50121314



10 / 11 mm
12 / 14 mm

3/8 in
3/8 in

50 BBR501011
50 BBR50121314

Air brake system bleeder



BBR350



1/4" in 300 x 125 x 125 mm

1 BBR350

12V Electrical Brake Bleeder



BBRBB12



895 x 390 x 395 mm 14.6 kg

1 BBRBB12

Brake bleeder master cylinder cap adapter kit



Brake Bleeder Master Cylinder Cap Adapter Kit Contents



BBRAS14-01/BBRAS14-14



PN5 in	Universal	1	BBRAS14-01
PN5 in	Honda	1	BBRAS14-02
PN5 in	Honda Accord	1	BBRAS14-03
PN5 in	Universal	1	BBRAS14-04
PN5 in	Chrysler, Jeep, Plymouth	1	BBRAS14-05
PN5 in	Chrysler, Jeep, Plymouth, Dodge	1	BBRAS14-06
PN5 in	Nissan	1	BBRAS14-07
PN5 in	Alfa Romeo, Fiat, Peugeot, Citroën, Audi, BMW, Jaguar, Land-Rover, Mercedes, Porsche, Renault, Saab, VW, Volvo, Chrysler, Daewoo, Ford, Kia, Mazda, Mini, etc	1	BBRAS14-08
PN5 in	Hyundai, Mitsubishi, Nissan, Subaru, Chrysler, Dodge, Ford, etc.	1	BBRAS14-09
PN5 in	GM Models and Mazda	1	BBRAS14-10
PN5 in	Toyota and Lexus	1	BBRAS14-11
N/A in	Holder for universal adaptor	1	BBRAS14-12
N/A in	Syringe	1	BBRAS14-13
N/A in	Hooks, chains and roulettes for BBRAS14-01 and BBRAS14-04	1	BBRAS14-14

Brake pad thickness gauge



BBRPTG1



68 g

10 BBRPTG1

BBRAS14



PN5 in 85 x 350 x 445 mm 4 BBRAS14



Micrometer with magnetic base



1154



230 x 50 x 75 mm

1 1154

1154-DG



1154-MB



Dial indicator



1154-DG



0-10 mm

0.01 mm

1 1154-DG

Magnetic base holder



1154-MB



70 x 96 x 297 mm 230 + 150 mm

1 1154-MB

Aluminium caliper



BBR400



6 x 89 x 120 mm

1 BBR400

Digital caliper for brake discs



BBR420



0-60 mm 35 x 104 x 176 mm

50 BBR420

Digital Brake Caliper



BBR405



460 mm

20 BBR405

Brake brush, steel



783



223 mm

1 783

Caliper for measuring brake disc and brake shoe diameters



BBR410



20 x 210 x 280 mm 0.610 kg

24 BBR410

Brake caliper wind-back air tool



BBR320



3/8 in

1/4" in

1 BBR320

Universal brake caliper tool set 50 pieces



BBR300P50

82 x 350 x 425 mm	5.56 kg	4	BBR300P50

T30	78 mm	1	BBR203P930
T40	78 mm	1	BBR203P940
T45	78 mm	1	BBR203P945
T50	78 mm	1	BBR203P950
T55	78 mm	1	BBR203P955
T60	78 mm	1	BBR203P960

XZN 1/2" impact socket bit set for brakes



BBR201P6

68 x 225 x 225 mm	8	BBR201P6	

BBR201P67814, BBR201P67816, BBR201P67818, BBR201P64018, BBR201P64014, BBR201P64016

1/2 impact socket driver XZN



BBR201P64014-BB201P67818

M14	40 mm	1	BBR201P64014	
M16	40 mm	1	BBR201P64016	
M18	40 mm	1	BBR201P64018	
M14	78 mm	1	BBR201P67814	
M16	78 mm	1	BBR201P67816	
M18	78 mm	1	BBR201P67818	

1/2" impact socket drivers with Torx bits for brakes



BBR203P920-BBR203P960

T20	78 mm	1	BBR203P920	
T25	78 mm	1	BBR203P925	
T27	78 mm	1	BBR203P927	

1/2" pentagon socket and bit set for hand brake



BBR202P4

43 x 90 x 200 mm	1	BBR202P4
	1	BBR202P410
	1	BBR202P414
	1	BBR202P419
	1	BBR202P455

Shoe brake springs removal and installation set



BBR210P3

80 x 270 x 375 mm	1	BBR210P3
25 x 59 x 182 mm	1	BBRS210P
75 x 270 x 350 mm	1	BBRS210P2

Brake spring pliers with pivoting head



BBR6135

335 mm	1	BBR6135



Brake spring pliers



BBR6131



210 mm



1 BBR6131

Hand Brake Cable Pliers



BBR204



235 mm



21,9 mm



6 BBR204

Brake Circuit Clamps



BBR150i



13.5 mm



10 x 52 x 165 mm



24 BBR150i

Flaring Kit



BBRFKM1



141 x 115 x 195 mm



1551 g



12 BBRFKM1

TRANSMISSION & WHEEL TOOLS

Wheel wrenches



29-B/BWXW1/BWXW2



17,19,21 mm

1/2 in

1 29-B

17,19,22 mm

1/2 in

1 BWXW1

24,27,32 mm

3/4 in

1 BWXW2

17, 19, 21, 22 mm

1 BWXW3

24, 27, 32, 38 mm

1 BWXW4

17, 19, 21, 22 and 24 mm impact wheel socket set



BWSS12P5



17, 19, 21,
22, 24 mm

175 x 240 x 50 mm

1 BWSS12P5

BWSS12P319, BWSS12P317,
BWSS12P524, BWSS12P522, BWS-
S12P321



Wheel socket sets



BWSS12P



1/2 in

17 mm

1 BWSS12P317

1/2 in

19 mm

1 BWSS12P319

1/2 in

21 mm

1 BWSS12P321

1/2 in

22 mm

1 BWSS12P522

1/2 in

24 mm

1 BWSS12P524

17, 19 and 21 mm impact wheel socket set



BWSS12P3



17, 19, 21 mm 45 x 125 x 145 mm

20 BWSS12P3

15 mm impact wheel socket



BWSMB15



15 mm

25 BWSMB15

BWSS12P317, BWSS12P319, BWS-
S12P321



17 mm impact socket for Mercedes anti-theft wheel nut



BWSMB17

17 mm	1	BWSMB17

21 mm anti-theft impact socket for Hyundai and KIA



BWSHK21

1/2" in	21 mm	25	BWSHK21

17, 19 and 21 mm long reach impact wheel socket set



BWSS12P3L

17, 19, 21 mm	68 x 225 x 225 mm	1	BWSS12P3L

BWSS12P317L, BWSS12P319L, BWSS12P321L

1/2" long reach impact wheel socket



BWSS12PL

1/2 in	17 mm	1	BWSS12P317L
1/2 in	19 mm	1	BWSS12P319L
1/2 in	21 mm	1	BWSS12P321L

Long twist socket set 1/2" 17, 19 and 21 mm



BWTSP3L

68 x 225 x 150 mm	1	BWTSP3L

BWTSP317L, BWTSP319L, BWT-SP321L

Deep 1/2" Twist Sockets 150 mm long



BWTSP317L-BWTSP321L

1/2 in	17 mm	1	BWTSP317L
1/2 in	19 mm	1	BWTSP319L
1/2 in	21 mm	1	BWTSP321L

Twist socket set 1/2" 17, 19, 21, 22, 24 mm



BWTSP6

55 x 105 x 217 mm	1	BWTSP6

BWTSP619, BWTSP617, BWTSP622, BWTSP621, BWTSP624

Deep Twist Sockets



BWTSP617-BWTSP624

17 mm	1/2 in	1	BWTSP617
19 mm	1/2 in	1	BWTSP619
21 mm	1/2 in	1	BWTSP621
22 mm	1/2 in	1	BWTSP622
24 mm	1/2 in	1	BWTSP624

Twist socket set



BWTSP7

52 x 117 x 207 mm	1	BWTSP7

1/2": 22, 24, 27, 32 mm & 3/4": 36, 41 mm



Twist socket sets



BWTSP16

48 x 125 x 245 mm	1	BWTSP16

3/8": 8, 10, 11, 12, 13, 14, 16, 17, 18, 19 mm & 1/2": 21, 22, 24, 27 mm

Twist socket



BWTSP

8 mm	3/8 in	1	BWTSP1608
10 mm	3/8 in	1	BWTSP1610
11 mm	3/8 in	1	BWTSP1611
12 mm	3/8 in	1	BWTSP1612
13 mm	3/8 in	1	BWTSP1613
14 mm	3/8 in	1	BWTSP1614
16 mm	3/8 in	1	BWTSP1616
17 mm	3/8 in	1	BWTSP1617
18 mm	3/8 in	1	BWTSP1618
19 mm	3/8 in	1	BWTSP1619
21 mm	1/2 in	1	BWTSP1621
22 mm	1/2 in	1	BWTSP1622
24 mm	1/2 in	1	BWTSP1624
27 mm	1/2 in	1	BWTSP1627
32 mm	1/2 in	1	BWTSP732
36 mm	3/4 in	1	BWTSP736
41 mm	3/4 in	1	BWTSP741

Set of 5 torsion bars with 1/2" drive designed for tightening wheel nuts with an impact wrench without exceeding the recommended torque



BWTB12P5

68 x 225 x 280 mm	1.74 kg	1	BWTB12P5

BWTB12P90, BWTB12P100, BWTB12P110, BWTB12P120, BWTB12P135

Torsion bars with 1/2" drive designed for tightening wheel nuts with an impact wrench without exceeding the recommended torque



BWTB1290-BWTB12P200

	Nm		
200 mm	100 N·m	1	BWTB12P100
200 mm	110 N·m	1	BWTB12P110
200 mm	120 N·m	1	BWTB12P120
200 mm	135 N·m	1	BWTB12P135
200 mm	150 N·m	1	BWTB12P150
200 mm	160 N·m	1	BWTB12P160
200 mm	175 N·m	1	BWTB12P175
200 mm	190 N·m	1	BWTB12P190
200 mm	200 N·m	1	BWTB12P200
200 mm	90 N·m	1	BWTB12P90

1" impact torsion bars



BZWBTB

32 mm	450 N·m	1	BZWBTB0132450
32 mm	600 N·m	1	BZWBTB0132600

Wheel bolt bag



BWBB

0.023 kg	180 x 1 x 300 mm	200	BWBB

Thread Tapping Set



BWHTRS12

225 x 67 x 225 mm	1350 g	15	BWHTRS12

Tyre lever



38-8 - 38-24

Length (mm)	Quantity	Part Number
200 mm	5	38-8
300 mm	5	38-12
400 mm	5	38-16
500 mm	2	38-20
600 mm	1	38-24

Tyre lever, special bent form



39-24

Length (mm)	Quantity	Part Number
605 mm	1	39-24

Digital tyre tread depth gauge



BWTDG1

Length (mm)	Dimensions (mm)	Quantity	Part Number
0 - 25 mm	30 x 76 x 156 mm	50	BWTDG1

Tyre levers



38A

Length (mm)	Quantity	Part Number
200 mm	25	38A-08
240 mm	25	38A-10
304 mm	1	38A-12
382 mm	25	38A-15
537 mm	1	38A-21
655 mm	1	38A-26

Wheel Chocks



BWC1

Dimensions (mm)	Quantity	Part Number
75 x 77 x 110 mm	25	BWC1

Tyre pressure gauge



BWTPG1

Dimensions (mm)	Quantity	Part Number
20 x 90 x 394 mm	10	BWTPG1

Tyre lever for commercial vehicles and trucks



38C

Length (mm)	Quantity	Part Number
645 mm	1	38C-26

Wheel balancing pliers



BWP150

Dimensions (mm)	Quantity	Part Number
20 x 87 x 255 mm	1	BWP150

Tire Pressure Monitoring System Maintenance Tool Set



BWTPMSS9

Dimensions (mm)	Weight (g)	Quantity	Part Number
68 x 225 x 225 mm	1049 g	8	BWTPMSS9



Tire valve core tool with 0.45 Nm max torque



BWTVCTT355

0.45 N·m	0.33 lbf·ft	1	BWTVCTT355

1/2" impact socket with bihex profile



BT15P524-BT15P536

1/2 in	24 mm	1	BT15P524
1/2 in	30 mm	1	BT15P530
1/2 in	32 mm	1	BT15P532
1/2 in	36 mm	1	BT15P536

Impact sockets BPW



BHVISxxBPW

3/4 in	111 mm	1	BHVIS111BPW12
3/4 in	80 mm	1	BHVIS80BPW12
3/4 in	95 mm	1	BHVIS95BPW9

Tyre Nozzle Deflation Caps



BWTPMSS4C

27 x 59 x 108 mm	60 g	25	BWTPMSS4C

3/4" heavy vehicle impact sockets Scania, Volvo



BHVIS08

3/4 in	95 mm	1	BHVIS0895
3/4 in	100 mm	1	BHVIS08100
3/4 in	115 mm	1	BHVIS08115
	109 mm	1	BHVIS109BPW12
	120 mm	1	BHVIS120BPW16

Wheel hub plate with slide hammer and hydraulic spindle



BWHEPSSH8

12 to	#4-5/116-135 mm	1	BWHEPSSH8

1/2" impact socket and bit set



BT15P5

60 x 85 x 255 mm	1	BT15P5

1" thin wall impact sockets



BHVIS12 / BHVIS06

12	68 mm	1	BHVIS1265
6	70 mm	1	BHVIS0670
6	77 mm	1	BHVIS0677
6	80 mm	1	BHVIS0680
6	85 mm	1	BHVIS0685
6	90 mm	1	BHVIS0690
6	95 mm	1	BHVIS0695
6	100 mm	1	BHVIS06100
6	105 mm	1	BHVIS06105

Wheel hub hydraulic puller



BWHEPS

12 to	#4-5 / 116-135 mm	1	BWHEPS

BWHEP



BWHEHS



Set of wheel hub plate and slide hammer



BWHEPSH8







#4-5 / 116-135 mm 960 x 150 x 150 mm 1 BWHEPSH8

5 kg slide hammer



BWSH5







100 x 100 x 985 mm 2 BWSH5

M18 adaptor



BWSH51







M38 mm M18x38 1 BWSH51

Wheel hub plate



BWHEP







#4-5 / 116-135 mm 90 x 147 x 147 mm 1 BWHEP

Slide hammer, 8 kg



BWSH8





960 x 100 x 100 mm 1 BWSH8

Steering Arm Inner Tie Rod Removal Tool Cages



BS5228-BS523945

28-34 mm 1 BS5228341
 34-40 mm 1 BS5234401
 39-35 mm 1 BS5239451

12 T hydraulic spindle



BWHEHS





12 to 265-282 mm 1 BWHEHS

3.5 kg mass



BSSHE3





60 mm 100 mm 1 BSSHE3

Stainless strap and buckles



BE2512005





5 mm 12 m 1 BE2512005



Stainless steel strap pliers



BE251200

170 mm 1 BE251200

CV boot installation pneumatic tool



BPCVB1

25-110 mm 6 BPCVB1

Stainless strap and buckles



BE2512008

8 mm 15 mm 1 BE2512008

Steering Arm Inner Tie Rod Removal Tool Set.



BS52

110 x 315 x 380 mm 3.08 kg 1 BS52

Axle joint tool



BS54

57 x 57 x 70 mm 1 BS54

Tie Rod End Extractor



BS56

1/2 in 57 x 57 x 57 mm 6 BS56

Rear Axle Eccentric Socket



BS45BMW

1/2 in 40 x 43 x 43 mm 20 BS45BMW

Camber Adjusting Tool



BS40VAG

22 mm 52 x 92 x 150 mm 20 BS40VAG

Wheel Bearing Tool Set



BWB14

80 x 300 x 525 mm 2 BWB14

Bearing removal and installation set



BT20P26



150 x 310 x 535 mm

1 BT20P26

Hydraulic Bearing Removal and Installation Set



BT20P49



164 x 520 x 890 mm

1 BT20P49

Ball joint fork puller



BS6



18 mm

400 mm

1 BS618

23 mm

400 mm

1 BS623

Ball joint extractor set with 12T hydraulic spindle



BWHPJ12



12 to

70 mm

4 BWHPJ12

VW T4 Supporting Joint Tool



4594VWT4



245 x 112 x 320 mm

5 4594VWT4

Ball joint socket puller for PSA



BS100PSA1



56 mm

52 mm

1 BS100PSA1

SAC Clutch Tool Set



BE301



80 x 395 x 430 mm

2 BE301

Centring Mandrels Set for SAC Clutches



BE301CM-SET



26 x 81.5 x 200 mm

50 BE301CM

BE301CM-01, BE301CM-02

Centring Mandrels for SAC Clutches



BE301CM



15.19 mm

174 mm

20 BE301CM-01

20.26 mm

174 mm

20 BE301CM-02



Clutch alignment rectifier



BE310

68 x 225 x 280 mm	1.14 kg	8	BE310

42 x 160 x 160 mm	1	BS15160
42 x 160 x 170 mm	1	BS15160C
42 x 160 x 212 mm	1	BS15212
24 x 160 x 215 mm	1	BS15212C
45 x 56 x 95 mm	1	BS1550

Double Pneumatic Piston Shock Absorber Compressor with Protective Screen



BS30PG

1180 x 500 x 625 mm	24 kN	1	BS30PG

Moving height extension



BS30AC1

336 x 545 x 450 mm	1	BS30AC1

SUSPENSION TOOLS & EQUIPMENT

Suspension arm lever bar



BS25

20 N·m	200 kg	1	BS25

Universal Shock Absorber Blocking System



BS10AC2

400 x 400 x 200 mm	1 kg	1	BS10AC2

Turnbuckle shock absorber



BS1000

70 x 405 x 575 mm	1	BS1000
	1	BS100001
	1	BS100002
	1	BS100003
	1	BS100004
	1	BS100005
	1	BS100006
	1	BS100007
	1	BS100008
	1	BS100009
	1	BS100010
	1	BS100011
	1	BS100012
	1	BS100013
	1	BS100014
	1	BS100015
	1	BS100016
	1	BS100017
	1	BS100018
	1	BS100019
	1	BS100020
	1	BS100021
	1	BS100022
	1	BS100023
	1	BS100024
	1	BS100025
	1	BS100026

MacPherson spring compressor



BS15

125 x 425 x 510 mm	1	BS15
43 x 110 x 160 mm	1	BS15125
165 x 160 x 385 mm	1	BS15125C

1	BS100027	
1	BS100028	
1	BS100029	
1	BS100030	
1	BS100031	
1	BS100032	
1	BS100033	
1	BS100034	
1	BS100035	
1	BS100036	
1	BS100037	
1	BS100038	
1	BS100039	

Booster 12/24V 2400 / 1200 CA



BBAGM1224-2400

	CA		
12 / 24 V	2400 / 1200 A	1	BBAGM1224-2400

Spare Booster 12V Charging Cable



BBAGMCAB

25 x 80 x 200 mm	12 V	1	BBAGMCAB

BATTERY MANAGEMENT & ELECTRICAL TOOLS

On Board Diagnostic Memory Saver Detector



BELMS12OBDL

40 x 70 x 140 mm	8	BELMS12OBDL

Spare battery for 12V boosters



BBAGMBAT

12 V	25 A·h	1	BBAGMBAT

12V/24V Heavy Duty Booster



BBA1224-3200

	CA		
12/24 V	3200/1600 A	1	BBA1224-3200

Booster 12V 1200 CA



BBAGM12-1200

	CA		
12 V	1200 A	1	BBAGM12-1200

Automatic electronic booster chargers



BBAGMCHG

70 x 105 x 130 mm	1	BBAGMCHG

12V Hybrid Booster with Capacitors



BBH12-1200

	CA		
12 V	1200 A	1	BBH12-1200



Jumper leads



BBJL



16 mm ²	3 m	5	BBJL1630
25 mm ²	3.5 m	1	BBJL2535
35 mm ²	4.5 m	1	BBJL3545

10 Amp Fully Automatic Charger/Maintainer for 12V Batteries



BBCE12-10

V	A		2 BBCE12-10
12V	10A		

100A Battery Charger/Power Supply



BBCE12-F100

V	A		1 BBCE12-F100
12 V	4/20/70/100AA		

3 Amp Fully Automatic Charger/Maintainer for 12V Lead-acid and Lithium LiFeP04 Batteries



BBCE12-3

V	A		2 BBCE12-3
12V	3A		

15 Amp Fully Automatic Charger/Maintainer for 12V Batteries with Supply Mode



BBCE12-15S

V	A		2 BBCE12-15S
12V	10/15A		

Mobile charger/starter



BBC420-BBC620

V			1 BBC420
230 V	20/1000 A-h		
230 V	20/1550 A-h		1 BBC620

6 Amp Fully Automatic Charger/Maintainer for 12V Batteries



BBCE12-6

V	A		2 BBCE12-6
12V	6A		

10 Amp Fully Automatic Charger/Maintainer for 24V Batteries



BBCE24-10

V	A		2 BBCE24-10
24V	10A		

Hydrometer battery tester



BB10

		1 BB10
50 x 50 x 285 mm		

12V digital battery tester



BBT20



90 x 160 x 345 mm

1 BBT20

Digital multimeter, autoranging, true RMS 1000V, with port for connection to PC



BMMTRMS1



155 x 60 x 225 mm 0.8 kg

1 BMMTRMS1

IR & RF key tester



BELTKEY



35 x 63 x 160 mm

1 BELTKEY

12V Digital Battery Tester



BBT60A



27 x 95 x 135 mm

36 BBT60A

1000V Voltage Absence Tester, Non-Contact Voltage Tester



BMVAT1000



310 x 50 x 100 mm 0.302 kg

50 BMVAT1000

Socket tester 7 pin 12V



BELT127



35 x 63 x 160 mm

1 BELT127

6V & 12V Digital Battery Tester with Printer



BBT80



64 x 130 x 251 mm

6 BBT80

1000A AC/DC True RMS Digital Clamp Meter



BDACM1000



60 x 143 x 250 mm 0.551 kg

30 BDACM1000

12V Vehicle Lamps Operation Plug Socket Tester



BELT1213A



40 x 138 x 205 mm 1.726 kg

20 BELT1213A



24V Vehicle Lamps Operation Plug Socket Tester



BELT2415A

40 x 138 x 205 mm 1.897 kg 20 BELT2415A

Socket tester 7 Pin 24V (24N)



BELT247N

55 x 63 x 160 mm 1 BELT247N

Socket tester 7 pin 24V (24S)



BELT247S

35 x 63 x 155 mm 1 BELT247S

Professional gas soldering iron



BGIS125

25-125 W 46 x 88 x 295 mm 20 BGIS125

Terminal set 16 pcs



BELTRP16

58 x 215 x 265 mm

- 1 BELTRP16
- 1 BELTRP1601
- 1 BELTRP1602
- 1 BELTRP1603
- 1 BELTRP1604
- 1 BELTRP1605
- 1 BELTRP1606
- 1 BELTRP1607
- 1 BELTRP1608
- 1 BELTRP1609
- 1 BELTRP1610
- 1 BELTRP1611
- 1 BELTRP1612
- 1 BELTRP1613
- 1 BELTRP1614
- 1 BELTRP1615
- 1 BELTRP1616

Memory saver 12V



BELS12

35 x 63 x 160 mm 1 BELS12

12V/24V peak protector



BELP1224

35 x 63 x 160 mm 1 BELP1224

Battery clamps (quick connect) for BBCE612-2, BBCE12-3 and BBCE12-6 chargers



BBCEC1

68 g 1 BBCEC1

Ring connectors (quick connect) for BBCE612-2, BBCE12-3 and BBCE12-6 chargers



BBCER1

100 g 1 BBCER1

Battery Clamps (quick connect) for Battery Clamps (quick connect) for BBCE12-10 and BBCE24-10 chargers



BBCEC2

68 g	1	BBCEC2

Ring connectors (quick connect) for BBCE12-10 and BBCE24-10 chargers



BBCER2

100 g	1	BBCER2

Booster charger cables - spares



BBBCAB

50 x 125 x 50 mm	1	BBBCAB-AUZ
50 x 125 x 50 mm	1	BBBCAB-EU
50 x 50 x 50 mm	1	BBBCAB-UK

PRESSES & ACCESSORIES

Bench Press, 15 Tonne



BH715

15.000 kg	1	BH715

Press, 20T, 30T and 50T

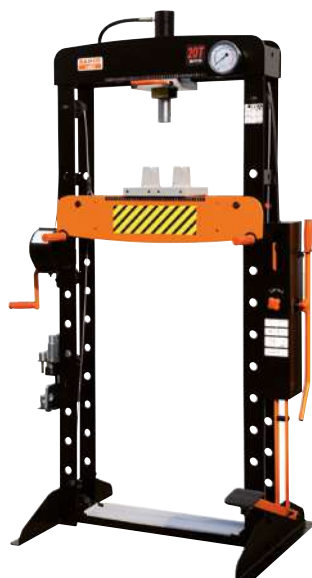

BH720/BH730/BH750

20.000 kg	1	BH720
30.000 kg	1	BH730
50.000 kg	1	BH750

Hydro-pneumatic press 100T



BH7100

100000 kg	1	BH7100A

Universal Press Supports 30 t



BH7PS30

225 x 100 x 275 mm	2	BH7PS30

Press pins set for presses



BH715-13

7.09 kg	1	BH715-13
7.09 kg	1	BH720-22



Safety grids for presses 15, 20, 30 and 50T



BH7 SG

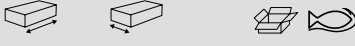

530 mm	20 mm	1	BH720SG
590 mm	20 mm	1	BH730SG
625 mm	20 mm	1	BH750SG

Safety grid for press 100ton



BH7100SG



150 x 593 x 625 mm	5.54 kg	1	BH7100SG
--------------------	---------	---	----------

GENERAL AUTOMOTIVE TOOLS AND EQUIPMENT

Multi-Purpose Tables



BLEMAT1



860 x 155 x 780 mm	28.7 kg	1	BLEMAT1
--------------------	---------	---	---------

Multi-Purpose Table Bottom Trays



BLEMAT1BT



50 x 760 x 890 mm	10.5 kg	1	BLEMAT1BT
-------------------	---------	---	-----------

Set of 4 Storage/Protection Bags for Wheels and Tyres



BWB1418S4/BWB1922S4

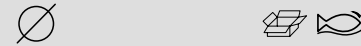

355 - 470 mm	6	BWB1418S4
470 - 560 mm	6	BWB1922S4

Magnetic dish



1419-MD

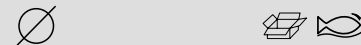

150 mm	1	1419-MD
--------	---	---------

Round magnetic dish



BMD150

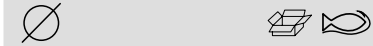

160 mm	1	BMD150
--------	---	--------

Rectangular magnetic tray



BMR240

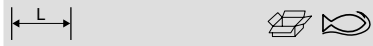

250 mm	1	BMR240
--------	---	--------

Pneumatic stool



BLE305

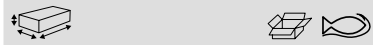

430 x 410 x 430 mm	1	BLE305
--------------------	---	--------

Pneumatic stool



BLE300



380 x 380 x 550 mm 136 kg 1 BLE300

Creepers and stool set



BLE304

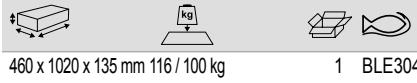

460 x 1020 x 135 mm 116 / 100 kg 1 BLE304

Car panel protector



BBS50



900 mm 1.2 mm 1 BBS50

Creepers and stool combo



BLE302



135 x 490 x 1010 mm 136 kg 1 BLE302

Seat cover



5750



1390 mm 1 5750

Dual Laser Headlamp Tester



BLBT100



1650 x 500 x 565 mm 1 BLBT100

Low profile creeper



BLE301

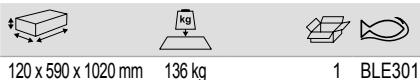

120 x 590 x 1020 mm 136 kg 1 BLE301

Multipurpose Vehicle Front Body Protector



5770

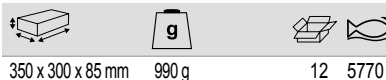

350 x 300 x 85 mm 990 g 12 5770

Rail track for BLBT100



BLBT100AC1



150 x 150 x 1025 mm 7.77 kg 1 BLBT100AC1



Multi-position ratcheting pry bar set



BT10P3



80 x 270 x 375 mm



1 BT10P3

Multi Position Prybar



BT10P325-BT10P338



250 mm
300 mm
380 mm



40 BT10P325
1 BT10P330
1 BT10P338

Long Pry Bar Set with Rubber Grip



BPBLS4



78 x 255 x 1000 mm



9050 g



2 BPBLS4

BPBL00900, BPBL30900, BPBL70600,
BPBL90600

Long Pry Bars with Rubber Grip



BPBL



930 mm
925 mm
610 mm
628 mm



5 BPBL00900
5 BPBL30900
5 BPBL70600
5 BPBL90600

BODY SHOP TOOLS

Universal holder with rubber vacuum pads



BBS3BH1



955 mm



1 BBS3BH1

Holder for bodywork shop



BBS3UH



950 x 800 x 1200 mm



20 kg



1 BBS3UH

Rubber suction cup



BBS075



160 mm



175 mm



12 BBS075

Vacuum Pad for Universal Holder



BBS3BH1-VP



60 x 95 x 95 mm



40 BBS3BH1-VP

Two double suction cups and belt



BBS150



120 mm



400 mm



1 BBS150

Glass run channel cleaner



BBS106

25 x 25 x 332 mm	0.145 kg	1	BBS106

Wire starter



BBS103

25 x 25 x 345 mm	1	BBS103

T-handle wire pushing tool



BBS102

265 mm	1	BBS102

Wire grip handle set



BBS101

30 x 80 x 115 mm	1	BBS101

Windscreen cut-out wires



BBS150S

50 m	1	BBS150R
50 m	1	BBS150S
50 m	1	BBS150T

Windscreen cut-out tool



BBS105

20 x 90 x 200 mm	1	BBS105

Urethane cutting knife



BBS10450

10 x 30 x 450 mm	0.240 kg	1	BBS10450

Blades for windscreen cut-out tool

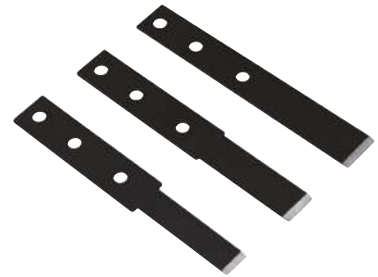

BBS107

1 x 18 x 125 mm	1	BBS107

Blades for windscreen cut-out tool



BBS108

20 x 19 x 88 mm	1	BBS108

WIPER ARM PULLER SET



BBS165

117 x 25 x 78 mm	10	BBS165



Wiper puller set



BBS170P13



80 x 275 x 375 mm



- 1 BBS170P13
- 1 BBS170P131
- 1 BBS170P132
- 1 BBS170P133
- 1 BBS170P134
- 1 BBS170P135
- 1 BBS170P136
- 1 BBS170P137
- 1 BBS170P138
- 1 BBS170P139
- 50 BBS165SP4

Bodywork dressing hammer



BBSH1M



50x30 mm



1 BBSH1M

Bodywork pein & finishing hammer



BBSH2F



40 mm



6 BBSH2F

Bodywork pein & finishing hammer



BBSH2C



40 mm



1 BBSH2C

Bodywork bumping hammer



BBSH3CF



40 mm



37 mm



6 BBSH3CF

12 kg slide hammer



BBS12SH



800 mm



12 kg



1 BBS12SH

Bodywork angled pein & finishing hammer



BBSH2CA



40 mm



12 BBSH2CA

Bodywork shop light bumping hammer



BBSH3CF30



30 mm



25 mm



6 BBSH3CF30

Bodywork dressing hammer



BBSH1F



50x30 mm



1 BBSH1F

Bodywork pick & finishing hammer



BBSH2CP



40 mm



6 BBSH2CP

Bodywork light shrinking hammer



BBSH3FS



37 mm



40 mm



6 BBSH3FS

Bodywork shrinking hammer



BBSH3MF



30 mm 27 mm 1 BBSH3MF

Spare handle for BBSH hammers



BBSHWH1

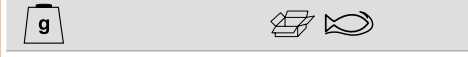

160 g 1 BBSHWH1

Bodywork American dolly



BBSDA

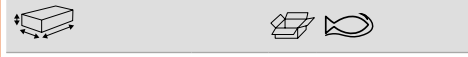

30 x 63 x 83 mm 1 BBSDA

Bodywork comma dolly



BBSDC

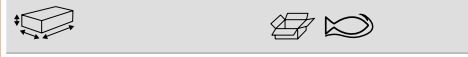

40 x 58 x 128 mm 6 BBSDC

Bodywork diablo dolly



BBSDD

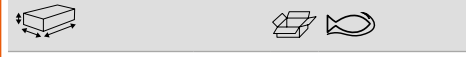

55 x 55 x 55 mm 1 BBSDD

Bodywork heel dolly



BBSDH

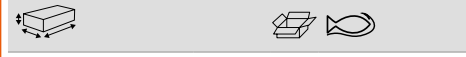

30 x 60 x 79 mm 1 BBSDH

Bodywork toe dolly



BBSDT

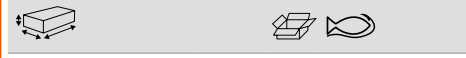

26 x 58 x 120 mm 6 BBSDT

Bodywork wedge dolly



BBSDW

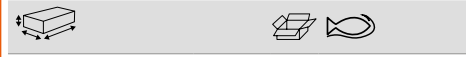

25 x 64 x 112 mm 6 BBSDW

Rubber heel dolly



BBSDHR

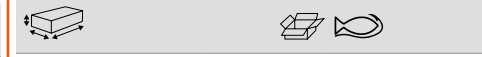

40 x 62 x 75 mm 1 BBSDHR

Bodywork single spoon



BBSS1

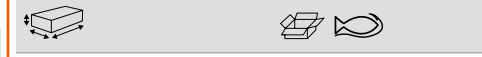

25 x 56 x 390 mm 1 BBSS1

Bodywork double spoon short



BBSS2



150 x 60 x 410 mm 8 BBSS2

Bodywork double spoon long



BBSS2L

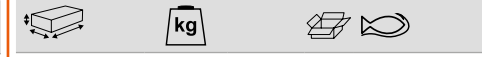

175 x 60 x 520 mm 2.3 kg 1 BBSS2L



Trim pad remover



2485



240 mm



1 2485

Trim pad removal pliers



BBS200



65 x 75 x 250 mm



1 BBS200

Trim remover



BBS20P12



35 x 355 x 585 mm



1 BBS20P12

Plastic repair set



BBS210



100 x 280 x 360 mm
22 x 64 x 106 mm
22 x 64 x 106 mm
22 x 64 x 106 mm
22 x 64 x 106 mm
22 x 64 x 106 mm
22 x 64 x 106 mm
22 x 64 x 106 mm
22 x 64 x 106 mm



1 BBS210
1 BBS210U06
1 BBS210U08
1 BBS210UA06
1 BBS210UA08
1 BBS210V06
1 BBS210V08
1 BBS210W06
1 BBS210W08

Airbag removal tool set 12 pcs



BBS100



55 x 160 x 275 mm



1 BBS100
1 BBS10001
1 BBS10002
1 BBS10003
1 BBS10004
1 BBS10005
1 BBS100057
1 BBS10006
1 BBS10007
1 BBS10008
1 BBS10009
1 BBS10010

Bodywork scraper set, 4 pcs



2220



125 g



1 22209004B

Nut riveter



1468-M6



20 x 110 x 265 mm



1 1468-M6

Nut riveter



1468-M10



50 x 210 x 575 mm



6 1468-M10

1468-M6 nut riveter inserts



1468-6M



15 x 15 x 50 mm	1	1468-6M3
13 x 13 x 50 mm	1	1468-6M4
25 x 25 x 55 mm	1	1468-6M5
20 x 20 x 55 mm	1	1468-6M6

1468-M10 Nut Riveter inserts



1468-10M



17 x 17 x 90 mm	1	1468-10M4
17 x 17 x 90 mm	1	1468-10M5
20 x 20 x 90 mm	1	1468-10M6
20 x 20 x 85 mm	1	1468-10M8
20 x 20 x 85 mm	1	1468-10M10

Portable ram sets 4T and 10T



BH8PR



220 x 480 x 1030 mm	31 kg	1	BH8PR10000
168 x 345 x 575 mm	18.65 kg	1	BH8PR4000

Body clamps



BH8BC1



45 x 135 x 230 mm	1	BH8BC1
-------------------	---	--------

Body clamps



BH8BC2



51 x 150 x 220 mm	1	BH8BC2
-------------------	---	--------

Body clamps



BH8BC3



90 x 65 x 240 mm	10	BH8BC3
------------------	----	--------

Body clamps



BH8BC4



80 x 120 x 175 mm	6	BH8BC4
-------------------	---	--------

Body clamps



BH8BC5



45 x 155 x 230 mm	6	BH8BC5
-------------------	---	--------

LIFTING EQUIPMENT

Welded bottle jack



BH4S



2000 kg	180 x 83 x 93 mm	6	BH4S2
4000 kg	190 x 91 x 100 mm	6	BH4S4
6000 kg	215 x 96 x 114 mm	4	BH4S6
8000 kg	230 x 103 x 120 mm	4	BH4S8
12000 kg	235 x 117 x 135 mm	3	BH4S12
20000 kg	240 x 145 x 153 mm	1	BH4S20
50000 kg	240 x 315 x 220 mm	1	BH4S50



Premium quality welded bottle jack



BH4

Capacity	Dimensions (mm)	Quantity	Model
2000 kg	180 x 103 x 103 mm	1	BH42
5000 kg	210 x 110 x 110 mm	1	BH45
10000 kg	220 x 124 x 128 mm	1	BH410
15000 kg	235 x 140 x 140 mm	2	BH415
20000 kg	240 x 165 x 160 mm	1	BH420
30000 kg	245 x 185 x 175 mm	2	BH430

2.5 T Aluminium Trolley Jack



BH1A2500A

Capacity	Dimensions (mm)	Quantity	Model
2500 kg	205 x 385 x 800 mm	1	BH1A2500A

Extra low entry, extra long reach



BH11500

Capacity	Dimensions (mm)	Quantity	Model
1500 kg	1270 x 364 x 945 mm	1	BH11500

Air Hydraulic Welded Bottle Jacks



BH4HP50

Capacity	Dimensions (mm)	Quantity	Model
50000 kg	300 x 210 x 310 mm	1	BH4HP50

Trolley jack, 3T



BH1EU3000

Capacity	Dimensions (mm)	Quantity	Model
3000 kg	1400 x 340 x 617 mm	1	BH1EU3000

Extra low entry



BH12000

Capacity	Dimensions (mm)	Quantity	Model
2000 kg	1270 x 364 x 780 mm	1	BH12000

1.5 T Aluminium Trolley Jack



BH1A1500A

Capacity	Dimensions (mm)	Quantity	Model
1500 kg	170 x 370 x 660 mm	1	BH1A1500A

Trolley jack, 1T



BH1M1000

Capacity	Dimensions (mm)	Quantity	Model
1000 kg	1280 x 478 x 700 mm	1	BH1M1000

Trolley jack 3T



BH13000

Capacity	Dimensions (mm)	Quantity	Model
3000 kg	1280 x 364 x 825 mm	1	BH13000

3T trolley jack with Quick Approach



BH13000QA

3000 kg	220 x 395 x 900 mm	1	BH13000QA

Cross beam adaptor, 1 T



BH1CB1000

1000 kg	145 x 125 x 710 mm	1	BH1CB1000

3T long chassis high elevation trolley jack



BH13000L

3000 kg	1310 x 530 x 1370 mm	1	BH13000L

Extra Long Trolley Jack, 5T



BH15000B

5000 kg	330 x 520 x 1670 mm	1	BH15000B

10T Extra Long Trolley Jack



BH110000B

10000 kg	270 x 520 x 1670 mm	1	BH110000B

120 mm extensions for jacks ref. BH15000A and ref. BH110000A



BH15000A-EXT/BH110000A-EXT

108 mm		1	BH15000A-EXT
151 mm		1	BH110000A-EXT

Scissor jack, 4T - 5T



BH1S45

4000 kg	1194 x 212 x 680 mm	1	BH1S45

Spare rubber saddle



BH1RS

BH1A1500A		40	BH1A1500A-05
BH1EU3000		1	BH1EU3000-03
BH11500, BH12000, BH13000, BH13000QA, BH13000L, BH1M1000, BH1A2500A		1	BH11500-04
BH15000A		1	BH15000A-04
BH110000A		1	BH110000A-04

Spare front wheels for jacks



BH1 FW

BH1A2500		1	BH1A2500-03
BH13000		1	BH13000-02
BH1EU3000		1	BH1EU3000-01
BH1M1000, BH11500, BH12000		1	BH11500-02
BH1S45		1	BH1S45-03
BH15000A		1	BH15000A-02
BH110000A		1	BH110000A-02



2 step balloon jacks



BH9BJ22SSH

2000 kg	345 x 265 x 265 mm	1	BH9BJ22SSH

2 step balloon jacks



BH9BJ22

2000 kg	1000 x 265 x 265 mm	1	BH9BJ22SLH

3 step balloon jacks



BH9BJ23SSH

2000 kg	490 x 250 x 250 mm	1	BH9BJ23SSH

3 step balloon jacks



BH9BJ23

2000 kg	1000 x 250 x 250 mm	1	BH9BJ23SLH

Extensions for pneumatic stage jacks



BH9BJ260_80

970 g 1180 g	1	BH9BJ260 BH9BJ280

Air hydraulic jack, 30T



BH230

360 mm 627 mm	1	BH230	

Compact air hydraulic jack, 15T - 30T



BH23015C

30000 kg	1350 x 290 x 430 mm	1	BH23015C

Air-hydraulic jack 30T/15T



BH23015

30000 kg	1250 x 282 x 810 mm	1	BH23015

Extra low entry air-hydraulic



BH2402010

40000 kg	1225 x 302 x 825 mm	1	BH2402010

Air-hydraulic



BH2604020

60000 kg	1250 x 295 x 875 mm	1	BH2604020

Pair of aluminium of jack stands, 2,500kg capacity



BH3AL2500

2500 kg	1	BH3AL2500

Square base jack stand



BH3SQ

7000 kg 15000 kg	2	BH3SQ7000 2 BH3SQ15000

Air Hydraulic Jacks 80/50T



BH28050

80000 kg	380 x 470 x 1200 mm	1	BH28050

Jack stands (pair)



BH33000/BH36000

3000 kg 6000 kg	1	BH33000 1 BH36000

Heavy duty jack stand



BH3HD8000

8000 kg	2	BH3HD8000

Adaptor set



BH2AC

67 mm 75 mm	45-75 mm	1	BH2AC1 1 BH2AC2

Auto-rising jack stands



BH3A

3000 kg 5000 kg 10000 kg	1	BH3A3000 1 BH3A5000 1 BH3A10000

Heavy duty jack stand



BH3HD12000

12000 kg	1	BH3HD12000



Heavy duty jack stand



BH3HD16000



16000 kg 1 BH3HD16000

Hydraulic transmission jack double piston
1000kg capacity



BH5DP1000QA

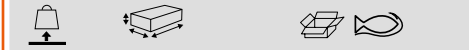

1000 kg 1954 x 759 x 759 mm 1 BH5DP1000QA

Storage rack for car dollies



BH1CD680ST

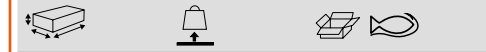

715 x 130 x 155 mm 135 kg 1 BH1CD680ST

20T Heavy Duty Jack Stand



BH3HD20000A

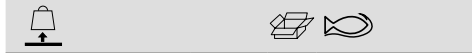

20000 kg 1 BH3HD20000A

Universal saddle for transmission jacks



BH5US1000

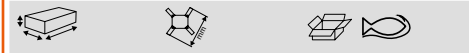

250 x 340 x 420 mm 260-510 mm 1 BH5US1000

Hydraulic Wheel Dolly 600kg capacity



BH8AC3-600



1030 x 1050 x 1020 mm 93.5 kg 1 BH8AC3-600

Hydraulic transmission jack single piston
500kg capacity



BH5SP500QA



500 kg 2041 x 660 x 660 mm 1 BH5SP500QA

Car dolly for vehicle manoeuvring



BH1CD680



16.22 kg 610 x 240 x 220 mm 1 BH1CD680

Hydraulic Wheel Dolly, 1.5T



BH8AC3-1500A



310 x 1070 x 1345 mm 132 kg 1 BH8AC3-1500A

Foldable europallet crane, 600 kg



BH6PC600

2315 x 1040 x 1480 mm	96 kg	1	BH6PC600

Foldable crane, 2T



BH6FC2000

2640 x 1220 x 1845 mm	170 kg	1	BH6FC2000

Hydraulic ISO VG15 oil spare can 250 ml



BHVG15-250

160 x 60 x 60 mm	220 g	1	BHVG15-250

Foldable crane 1T



BH6FC1000

2175 x 1030 x 1480 mm	85 kg	1	BH6FC1000

Engine Hoist Load Balancer



BH6AC1-680A

565 x 12 x 774 mm		1	BH6AC1-680A

Spare rear wheels for jacks



BH1_RW

BH1A1500	1	BH1A1500-04
BH1A2500	1	BH1A2500-04
BH1M1000, BH11500, BH12000, BH13000	1	BH11500-01
BH1EU3000	1	BH1EU3000-08
BH13000L	1	BH13000L-01
BH1S45-01	1	BH1S45-01
BH15000A, BH110000A	1	BH15000A-01





BAHCO



Lighting Equipment



HAND LIGHTS

Pocket Lamps with Torch



BLTS7P

45 lm	58	BLTS7P

Aluminium Flex Work Lights with Torch



BLTFC1

180 lm	20	BLTFC1

Slim Lights with Torch



BLTS10

400 lm	20	BLTS10

HEAD LIGHTS

Head Lights with Elastic Strap



BFRL11

260 lm	1	BFRL11

CABLE REELS

2-Phase 230 VAC Cable Reels without Lamp



BLCR230

230 V	800/2000 W	1	BLCR230FR
230 V	800/2000 W	1	BLCR230SC

Lamps with Cable Reels



BLCR24V

230/24 V	60 W	1	BLCR24VCL
230/24 V	60 W	1	BLCR24VLL

3-Phase 400 VAC Cable Reels without Lamp



BLCR400E

400 V	2800/5000 W	1	BLCR400E

Speed Control Adaptors for Cable Reels



BLCRSC

BLCR		
230PL,FR,SC	76 x 91 x 117 mm	1 BLCRSC1
24VCL,VLL	76 x 91 x 117 mm	1 BLCRSC2



Inspection Tools



ENDOSCOPES

Handheld Videoscopes with 3.5" LCD Screen



BE210

Dimensions	Weight (kg)	Accessories
5 x 50 x 56 mm	0.04 kg	1 ZHVIDEOBAT
40 x 44 x 75 mm	0.17 kg	1 ZHVIDEOCHA

Mirrored and Magnetic Tips for Endoscopes



BE200M

Angle	Tip Type	Quantity	Part Number
0°	Magnetic	4	1 BE200MAG4
0°	Magnetic	5.5, 5.8	1 BE200MAG55
	Magnetic	8	1 BE200MAG80
35°	Magnetic	5.5, 5.8	1 BE200MIR5535
45°	Magnetic	5.5, 5.8	1 BE200MIR5545
55°	Magnetic	5.5, 5.8	1 BE200MIR5555
35°	Magnetic	8	1 BE200MIR8035
45°	Magnetic	8	1 BE200MIR8045
55°	Magnetic	8	1 BE200MIR8055
35°	Magnetic	4	1 BE200MIR4035
55°	Magnetic	4	1 BE200MIR4055

Stethoscopes with Steel Probe



5050

Length (mm)	Quantity	Part Number
1050 mm	1	5050

Fibre Optic Lens Cables for Endoscopes



BE200C

Tip Diameter	Length	Quantity	Part Number
25 mm	10 m	1	BE200CAB250SH10
25 mm	25 m	1	BE200CAB250SH25
25 mm	3 m	1	BE200CAB250SH3
4 mm	1 m	1	BE200CAB40F1
5.5 mm	1 m	1	BE200CAB55F1
5.5 mm	3 m	1	BE200CAB55F3
5.8 mm	1 m	1	BE200CAB58SR1
5.8 mm	3 m	1	BE200CAB58SR3
8 mm	1 m	1	BE200CAB80SR1
8 mm	3 m	1	BE200CAB80SR3

STETHOSCOPES

Garage Stethoscope Set



BE220

Dimensions	Weight (kg)	Quantity	Part Number
130 x 370 x 340 mm	2.94 kg	1	BE220

Magnifying Swivel Head Mirrors



5515GV

Length (mm)	Head Diameter (mm)	Quantity	Part Number
215 mm	30 mm	1	5515GV

Telescopic Swivel Head Mirrors 52 mm



5515T-52

Length (mm)	Head Diameter (mm)	Quantity	Part Number
255-450 mm	52 mm	25	5515T-52

Pivoting Inspection Mirror with LED and Insulated Semi-rigid Cable



5515FL

550 mm	62 x 38 mm	10	5515FL

Repair Mirrors with Metal Handle 30 mm



5515M

210 mm	30 mm	1	5515M

MAGNIFIERS

Optical Magnifier



BOM10X

180 mm	10	BOM10X

Pivoting Inspection Mirror with UV and Insulated Semi-rigid Cable



5515FUV

550 mm	65x42 mm	1	5515FUV

Magnifying Small and Light Mirrors 18 mm



5515L

160 mm	21 mm	1	5515L

Optical Magnifiers 90 mm x 30 mm



3046-OP

105 mm	12	3046-OP

Plastic Repair Mirrors



5515B

220 mm	28.5 mm	25	5515B

Swivel Head Telescopic Pocket Mirrors



5515T

180-690 mm	30 mm	25	5515T





BAHCO



Extractors & Pullers



MECHANICAL

2-Arm Universal Pullers with Induction Hardened Spindle and Galvanized Finish



4532

25-80 mm	100 mm	1			4532-A
25-80 mm	200 mm	1			4532-AL
25-130 mm	100 mm	1			4532-B
25-130 mm	200 mm	1			4532-BL
50-160 mm	150 mm	1			4532-C
50-160 mm	300 mm	1			4532-CL
60-200 mm	150 mm	1			4532-D
80-250 mm	200 mm	1			4532-E
80-350 mm	200 mm	1			4532-F
110-520 mm	200 mm	1			4532-G
110-520 mm	300 mm	1			4532-G-SO
170-640 mm	225 mm	1			4532-H

4532/B: Spare body 4532K: Pair of spare arms 4532LK: Pair of long spare arms 4532/S: Spare spindles

Pair of Spare Arm for 4532 Extractor



4532K-4532LK

4532-A, 4532-B	100 mm	1			4532K1
4532-C, 4532-D	150 mm	1			4532K2
4532-E, 4532-F, 4532-G	200 mm	1			4532K3
4532-H	225 mm	1			4532K4
4532-AL, 4532-BL	200 mm	1			4532LK1
4532-CL	300 mm	1			4532LK2
4532-G-SO	300 mm	1			4532LK3
4532-E, 4532-F, 4532-G, 4532-G-SO	400 mm	1			4532LK4
4532-E, 4532-F, 4532-G, 4532-G-SO	500 mm	1			4532LK5

Spindle for 4532 Puller



4532-S

4532-0, 4532-A, 4532-AL, 4532-B, 4532-BL		1			4532-OAB/S
4532-C, 4532-CL, 4532-D		1			4532-CD/S
4532-E, 4532-F, 4532-G, 4532-G-SO		1			4532-EFG/S
4532-H		1			4532-H/S

2-Arm Universal Pullers with Galvanized Finish



4532-0

20-90 mm	100 mm	1			4532-0

4532-0/B: Spare body 4532K0: Pair of spare arms

2-Arm Universal Pullers with Long Arms/ Spindle and Galvanized Finish



3115

80-250 mm	300 mm	1			3115

2-Arm Universal Puller Set Displays with Galvanized Finish



4532ST/5

16700 g		1			4532ST/5

4532-A, 4532-B, 4532-C, 4532-D, 4532-E

3-Leg and Multi Arm Pullers



4533

150-700 mm	185 mm	1			4533HP
150-700 mm	200 mm	1			4533M
	185 mm	1			4533HPK
	200 mm	1			4533MK
		1			4533HP/S
		1			4533M/S

4533HP: hydraulic 4533M: mechanical 4533/S: Spare spindle 4533/K: Set of 3 spare arms

Hydraulic Rams with Galvanized Finish



4529

8 to 15 to	T_n max				
	60 N·m	1			4529-8
	70 N·m	1			4529-15

3-Arm Hydraulic Extractors



4528

50-350 mm	135 mm	1	4528-1		

4528K: Set of 3 spare arms 4528/B: Spare body 4533HP/S: Spare hydraulic spindle

2-Arm Heavy Duty Pullers with Galvanized Finish



4544

10-100 mm	80 mm	1	4544-1		
10-120 mm	120 mm	1	4544-2		
20-160 mm	160 mm	1	4544-3		
20-200 mm	200 mm	1	4544-4		
		1	4544-110/S		
		1	4544-220/S		
		1	4519-1/S		
		1	4544-440/S		

4544-1/4: w/2 arms 4544-10/30: w/3 arms 4544/B: spare body 4544K: spare arm 4544/S: spare spindle

3-Arm Heavy Duty Pullers with Galvanized Finish



4544-

10-100 mm	80 mm	1	4544-10		
10-120 mm	120 mm	1	4544-20		
20-160 mm	160 mm	1	4544-30		

2-Arm Heavy Duty Pullers with Galvanized Finish



4543

10-60 mm	40 mm	1	4543-1		
10-70 mm	74 mm	1	4543-2		
10-90 mm	84 mm	1	4543-3		
		1	4543-1/S		
		1	4543-2/S		
		1	4543-3/S		

4543-1/3: w/2 arms 4543-10/30: w/3 arms 4543/B: Spare body 4543K: Spare arm 4543/S: Spare spindle

3-Arm Light Duty Pullers with Galvanized Finish



4543-

10-60 mm	40 mm	1	4543-10		
10-70 mm	74 mm	1	4543-20		
10-90 mm	84 mm	1	4543-30		

2-Arm Pullers with Galvanized Finish



4541

20-150 mm	85 mm	1	4541-A		
40-220 mm	130 mm	1	4541-B		

4541/B: Spare body 4541K: Spare arm 4532-4519/S: Spare spindle

3-Arm Pullers with Galvanized Finish



4542

20-150 mm	85 mm	1	4542-A		
40-220 mm	130 mm	1	4542-B		

4542/B: Spare body 4541K: Spare arm 4532-4519/S: Spare spindle

2-Arm Puller with Galvanized Finish



4537

20-170 mm	130 mm	1	4537-1		
20-230 mm	200 mm	1	4537-2		
50-300 mm	250 mm	1	4537-3		
50-350 mm	350 mm	1	4537-4		

4537/B: Spare body 4537K: Spare arm 4532-4519/S: Spare spindle

3-Arm Pullers for 4528M1/4528M2/4528M3 Extractors



4528M

20-170 mm	130 mm	1	4528M1		
20-230 mm	200 mm	1	4528M2		
50-300 mm	250 mm	1	4528M3		
50-350 mm	350 mm	1	4528M4		
50-400 mm	400 mm	1	4528M5		

4528M/B: Spare body 4537K-4528MK: Spare arm 4532/S-4519/S: Spare spindle



2-Arm Pullers with Clamp and Galvanized Finish



4519

Icon 1		Icon 2		Icon 3	
20-110 mm	80-170 mm	1	4519-1		
40-150 mm	90-270 mm	1	4519-2		
40-150 mm	90-330 mm	1	4519-3		

4519/B: spare body 4519K: spare arm 4519/S: spare spindle

Scissor-Type Pullers with Galvanized Finish



4614

Icon 1		Icon 2		Icon 3	
6-100 mm	70-85 mm	1	4614-1		
10-140 mm	85-120 mm	1	4614-2		

4614/B: spare body 4614K: pair of spare arms 4543-4532/S: spare spindle

Multiple Extractors - 5 Pcs



4540

Icon 1		Icon 2		Icon 3	
30-170 mm	65-140 mm	1	4540-17		
		1	4540-17/S		
75-250 mm	77-180 mm	1	4540-25		
		1	4540-25/S		

Extractors for Separators



4552

Icon 1		Icon 2		Icon 3	
4551-A-B		1	4552-1		
4551-C		1	4552-2		
4551-D		1	4552-3		

4552/B: Spare body 4552K: Spare tie rod 4532/S: Spare spindle

Separators with Galvanized Finish



4551

Icon 1		Icon 2		Icon 3	
4552-1		1	4551-A		
4552-1		1	4551-B		
4552-2		1	4551-C		
4552-3		1	4551-D		

4551/S: spare spindle

Pullers and Separator Set with Galvanized Finish



4574

Icon 1		Icon 2		Icon 3	
105 x 300 x 360 mm		1	4574		

4532-A, 4532-C

4532LK1, 4532LK2

4551-C

4529-15

Ball Bearing Extractors without Arms



4581N-4583N

Icon 1		Icon 2		Icon 3	
4581NA, 4581NB		1	4581N-1		
4581NB2, 4581NC, 4582NA		1	4582N-1		
4581NC, 4582NA, 4582NB		1	4582N-2		
4582NA, 4583NA		1	4583N-1		
4582NA, 4582NB, 4583NB		1	4583N-2		

Extractors Spare Arms Set



4581NA-4583NB

Icon 1		Icon 2		Icon 3	
145 mm	4581N-1	1	4581NA		
120 mm	4581N-1	1	4581NB		
130 mm	4582N-1	1	4581NB2		
130 mm	4582N-1, 4582N-2	1	4581NC		
150 mm	4582N-1, 4582N-2, 4583N-1, 4583N-2	1	4582NA		
150 mm	4582N-2, 4583N-2	1	4582NB		
190 mm	4583N-1	1	4583NA		
235 mm	4583N-2	1	4583NB		

Ball Bearing Puller Set with Galvanized Finish



4580N/7

Icon 1		Icon 2		Icon 3	
66 x 192 x 287 mm		1	4580N/7		

4581N-1, 4582N-1, 4582N-2, 4583N-1, 4583N-2, 4581NA to 4583NB

Ball Bearing Extractor Set with Galvanized Finish



4578



75 x 235 x 285 mm

1 4578

4581N-1, 4582N-2, 4581NA, 4581NB, 4581NB2, 4581NC

Ball Bearing Internal Extractors with Gunmetal Finish



4521N



5-7 mm	1	4521N-00
7-9 mm	1	4521N-0
9-12 mm	1	4521N-A
10-13 mm	1	4521N-B
13-17 mm	1	4521N-C
14-19 mm	1	4521N-D
16-21 mm	1	4521N-E
18-23 mm	1	4521N-F
20-25 mm	1	4521N-G
25-30 mm	1	4521N-H
30-37 mm	1	4521N-I
35-42 mm	1	4521N-K
38-45 mm	1	4521N-L
43-50 mm	1	4521N-M
40-75 mm	1	4521N-S
70-115 mm	1	4521N-T

2-Arm Counter Stay Extractors with Galvanized Finish



4522



35-75 mm	1	4522-1
60-130 mm	1	4522-2

4522/B: Spare body 4522/K: Spare arm 4522/S: Spare spindle

Sliding Hammer Pulling Bars with Gunmetal Finish



4523G



Ø10x170 mm	1	4523G
------------	---	-------

Sliding Hammer Pulling Bars with Galvanized Finish



4524G



Ø16 x 250 mm	1	4524G
--------------	---	-------

Complete Workshop Puller Assortment Set - 9 Pcs



4521N/7



95 x 360 x 310 mm	6800 g	1	4521N/7
-------------------	--------	---	---------

4521N-B, 4521N-D, 4521N-H, 4521N-I, 4521N-L, 4521N-S, 4521N-G

4522-2, 4522-1

Universal Ball Joint Pullers with Galvanized Finish



4545-N



Max 50 mm	18-22 mm	1	4545-N1
Max 90 mm	27-36 mm	1	4545-N11
Max 50 mm	26 mm	1	4545-N2
60-80 mm	26 mm	1	4545-N21

4545/S: Spare spindle

Universal Hub Pullers with Galvanized Finish



4518



225 mm	140 mm	1	4518-3
225 mm	140 mm	1	4518-4
225 mm	140 mm	1	4518-5



Ball Joint Extractors with Galvanized Finish



4545

18 mm	1	4545-1
25 mm	1	4545-2
29 mm	1	4545-3
40 mm	1	4545-4
45 mm	1	4545-5

Internal and External Extractor with Sliding Hammer Set



4590SHS5

79 x 230 x 500 mm	4	4590SHS5

Mechanical Nut Splitters with Galvanised and Gunmetal Finish



4611

to M16	1	4611-2
to M24	1	4611-3

4611/S: spare spindles 4611/B: spare blades

Extractors Set for Car Maintenance



4577

70 x 340 x 425 mm	1	4577

4545-N2	
4532-B	
4614-1	
4521N-D, 4521N-B, 4521N-H, 4521N-I, 4521N-G, 4521N-L	
4522-1	

Mini Puller Set with Galvanized Finish



4579

65 x 210 x 275 mm	1	4579

4543-2, 4543-3, 4543-1020/B, 4543-30/B, 4543K220, 4543K330

Stud Removers with Chromed Plated



4553

5-20 mm	1	4553

Stud Removers with Galvanised and Gunmetal Finish



4591-4593

10-19 mm	1	4592
5-15 mm	1	4591
18-28 mm	1	4593

Hydraulic Nut Splitters with Galvanised and Gunmetal Finish



4610

M4-M14	1	4610-1

Stud Extractors Rolled Thread



1420-1424

Item	Quantity	Part Number
M 3-6	1	1420-1.4
M 6-8	1	1421-2.1
M 8-11	1	1422-3.1
M11-14	1	1423-4.8
M14-18	1	1424-6.2

Stud Extractors - 5 Pcs



1435/5

Dimensions	Weight	Quantity	Part Number
15 x 50 x 90 mm	110 g	1	1435/5

1423-4.8, 1420-1.4, 1422-3.1, 1421-2.1, 1424-6.2

Stud Extractors - 8 Pcs



1435/8

Dimensions	Weight	Quantity	Part Number
29 x 110 x 118 mm	700 g	1	1435/8

1420-1.4, 1421-2.1, 1422-3.1, 1423-4.8, 1424-6.2

Stud Extractors for Broken-Off Screws/
Bolts/Studs M5-M24



1419-M5/1419-M16

Item	Quantity	Part Number
M5-M10	1	1419-M5
M8-M14	1	1419-M8
M12-M20	1	1419-M12
M16-M24	1	1419-M16

Stud Extractor Set for Broken-Off Screws/
Bolts/Studs - 4 Pcs



1419/4

Item	Weight	Quantity	Part Number
M5-M24	430 g	1	1419/4

M5-M10; M8-M14; M12-M20; M16-M24

Multi Spine Extractors Set - 15 Pcs



BWMSP15

Dimensions	Weight	Quantity	Part Number
43 x 90 x 200 mm	0.54 kg	1	BWMSP15

Stud Extraction Bits with Blasted Finish



BWMSP15

Item	Quantity	Part Number
3 mm	1	BWMSP1501
4 mm	1	BWMSP1502
5 mm	1	BWMSP1503
5.5 mm	1	BWMSP1504
6 mm	1	BWMSP1505
8 mm	1	BWMSP1506
10 mm	1	BWMSP1507
1/8 in	1	BWMSP1508
3/16 in	1	BWMSP1509
1/4 in	1	BWMSP1510
3/8 in	1	BWMSP1511
11 mm	1	BWMSP1512
12 mm	1	BWMSP1513
14 mm	1	BWMSP1514
1/2 in	1	BWMSP1515

Stud Extractors for Broken-Off Screws/
Bolts/Studs M5-M16



1418S

Dimensions	Quantity	Part Number
25 x 127 x 162 mm M6-M16	1	1418S

1418-4, 1418-5, 1418-6, 1418-7.5, 1418-8.5



Stud Extractors with Alloy Steel



1418

M5-M8	1	1418-4
M8-M10	1	1418-5
D11-M12	1	1418-6
M12-M14	1	1418-7.5
M14-M16	1	1418-8.5

Flat Head Pinch Bars with Flat Shank



3680

400 mm	1	3680

Flat Head Pry Bar with Through Blade for Hammering



2484T-20/2484T-60

210 mm	1	2484T-20
312 mm	1	2484T-30
450 mm	1	2484T-45
600 mm	1	2484T-60

PRY BARS

Combination Pinch Bars with Hexagon Shank



2632

170 mm	1	2632

Flat Head Pry Bars with PP Handle



2484-20/2484-60

205 mm	1	2484-20
305 mm	1	2484-30
465 mm	1	2484-45
615 mm	1	2484-60

4 pcs Flat Head Pry Bars with Through Blade for Hammering



2484T/S4

42 x 145 x 693 mm	1950 g	1	2484T/S4

Flat Head Pinch Bars with Hexagon Shank



3684

406 mm	1	3684-16
457 mm	1	3684-18
609 mm	1	3684-24
760 mm	1	3684-30

Flat Head Pry Bar Set with PP Handle



2484/S4

42 x 145 x 693 mm	10	2484/S4

Rolling Head Pry Bar



3683

400 mm	1	3683

2484-20, 2484-30, 2484-45, 2484-60

Rolling Head Pry Bars with Phosphated Body



3681



304 mm	1	3681-11
406 mm	1	3681-16
503 mm	1	3681-20

PICKING TOOLS

ERGO™ Neodymium Magnetic Pick-Up Tool 4 mm x 290 mm



ergo®

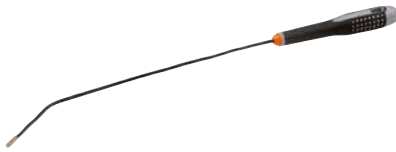

2535F0



5.5 mm	515 mm	1	2535F0
--------	--------	---	--------

BahcoFit Flexible Magnetic Pullers with Rubber Grip 10-18 mm



B147



13 mm	400 mm	1	B147.001.400
19 mm	400 mm	1	B147.003.400

Magnetic pick-up ERGO™



ergo®



2535F



10 mm	400 mm	1	2535F1
10 mm	400 mm	1	2535F2
17 mm	400 mm	1	2535F3

Magnetic pick-up tool with light



2535L



20 mm	40-670 mm	12	2535L
-------	-----------	----	-------

Flexible Pick-Up Tools with Steel Core



2509



555 mm	50	2509
--------	----	------

Claw Pick-Up Tools with Steel Core



2530



605 mm	1	2530
--------	---	------

THREAD TOOLS

Thread Cutting Toolset - 37 Pcs



1460M/1



53 x 407 x 220 mm	M5-M12	1	1460M/1
-------------------	--------	---	---------

Thread Cutting Toolset - 55 Pcs



1460M/2



53 x 407 x 220 mm	M5-M20	1	1460M/2
-------------------	--------	---	---------



Thread Cutting Toolset - 54 Pcs



1460Z/2



53 x 407 x 220 mm 1/4-3/4

1 1460Z/2

Tap Wrenches with Chrome Finish



600

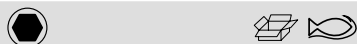

3-10 mm 1 600.003.010
5-12 mm 1 600.005.012

Imperial Double Thread Restorers



1450D-WW



230 mm

1 1450D-WW

Double Thread Restorers Set in Wooden Box



1450D/2

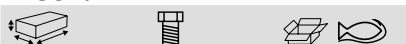

40 x 70 x 270 mm M5-M27

1 1450D/2

1450D-ISO

1450D-WW

Metric Double Thread Restorers



1450D-ISO



230 mm

1 1450D-ISO



Tool Storage & Toolkits



TOOL TROLLEYS

53" Tool Trolley General Purpose Tool Kit
- 488 Pcs



XXL



986 x 501 x 1430 mm



1 XXL

1476KXXL7BK	
2058-BR	
6700SM-10, 6700SM-11, 6700SM-12, 6700SM-13, 6700SM-14, 6700SM-4, 6700SM-4.5, 6700SM-5, 6700SM-5.5, 6700SM-6, 6700SM-7, 6700SM-8, 6700SM-9	
6700TORX-E10, 6700TORX-E4, 6700TORX-E5, 6700TORX-E6, 6700TORX-E7, 6700TORX-E8	
6950SL	
6954	
6956	
6960, 6962, 6962L, 696EX-11	
6963	
6966	
6972H	
7400SM-10, 7400SM-11, 7400SM-12, 7400SM-13, 7400SM-14, 7400SM-15, 7400SM-16, 7400SM-17, 7400SM-18, 7400SM-19, 7400SM-20, 7400SM-21, 7400SM-22, 7400SM-6, 7400SM-7, 7400SM-8, 7400SM-9	
7400TORX-E10, 7400TORX-E11, 7400TORX-E12, 7400TORX-E14, 7400TORX-E16, 7400TORX-E18, 7400TORX-E8	
7406ZZ-16, 7406ZZ-21	
7409BH-10, 7409BH-4, 7409BH-5, 7409BH-6, 7409BH-8	
7409F-10, 7409F-6.5, 7409F-8	
7409TORX-R-T27, 7409TORX-R-T30, 7409TORX-R-T40, 7409TORX-R-T45, 7409TORX-R-T50	
7409TORX-T25, 7409TORX-T27, 7409TORX-T30, 7409TORX-T40, 7409TORX-T45, 7409TORX-T50	
7750SL	
7757, K6650-1/4-1P	
7758	
7759	
7760	

7761-W	
7764	
7765	
7766	
7767	
776EX-11	
7800SM-10, 7800SM-11, 7800SM-12, 7800SM-13, 7800SM-14, 7800SM-15, 7800SM-16, 7800SM-17, 7800SM-18, 7800SM-19, 7800SM-20, 7800SM-21, 7800SM-22, 7800SM-23, 7800SM-24, 7800SM-25, 7800SM-26, 7800SM-27, 7800SM-28, 7800SM-29, 7800SM-30, 7800SM-32, 7800SM-33, 7800SM-34, 7800SM-36, 7800SM-8, 7800SM-9	
7800TORX-E10, 7800TORX-E11, 7800TORX-E12, 7800TORX-E14, 7800TORX-E16, 7800TORX-E18, 7800TORX-E20, 7800TORX-E24, 7800TORX-E8	
7805SM-10, 7805SM-12, 7805SM-13, 7805SM-14, 7805SM-15, 7805SM-16, 7805SM-17, 7805SM-18, 7805SM-19, 7805SM-20, 7805SM-21, 7805SM-22, 7805SM-23, 7805SM-24, 7805SM-25, 7805SM-26, 7805SM-27, 7805SM-28, 7805SM-29, 7805SM-30, 7805SM-32	
7809M-10, 7809M-12, 7809M-14, 7809M-4, 7809M-5, 7809M-6, 7809M-7, 7809M-8	
7809M-10-140, 7809M-5-100, 7809M-6-100, 7809M-7-100, 7809M-8-120	
7809XZN-10, 7809XZN-10-100, 7809XZN-12, 7809XZN-12-100, 7809XZN-14, 7809XZN-14-100, 7809XZN-16, 7809XZN-18, 7809XZN-6, 7809XZN-8, 7809XZN-100	
8150SL	
8160-3, 8160-5	
8160W-10	
8164-1/2	
8171	
8166	
8167	
A6800DM-10, A6800DM-11, A6800DM-12, A6800DM-13, A6800DM-14, A6800DM-4, A6800DM-5, A6800DM-5.5, A6800DM-6, A6800DM-7, A6800DM-8, A6800DM-9	
A7402DM-10, A7402DM-11, A7402DM-12, A7402DM-13, A7402DM-14, A7402DM-15, A7402DM-16, A7402DM-17, A7402DM-18, A7402DM-19, A7402DM-21, A7402DM-21, A7402DM-7, A7402DM-8, A7402DM-9	
K6625-1/4-1P	
K6650-1/2-1P, K6650-3/8-1P	
2101G-160	
2421 G-140IP, 2421 G-180	
2427 G-200	
2430 G-160	
2628 G-180	
2800-140, 2800-180, 2800-225	
2890-125, 2890-180, 2890-210	
2900-140, 2900-180, 2900-215	
2951-250	
2952-165	
2990-140, 2990-180, 2990-200	
3416 A	
4130	
7224	

BE256-155, BE256-178, BE256-250	
BLTS7P	
CR W 01	
1150-1/2H/P	
1544	
2633/S4x 4	
59/S100BCx 100	
806-1-3	
808050L	
BE-7607	
BE-8020L	
BE-8155TB, BE-8256TB, BE-8258TB	
BE-8355	
BE-8600	
BE-8602	
BE-8610TB, BE-8620TB, BE-8623TB, BE-8624TB	
BE-8802	
BE-8810TB, BE-8820TB, BE-8823TB, BE-8824TB	
BE-8907, BE-8908, BE-8909, BE-8910, BE-8915, BE-8920, BE-8925, BE-8927, BE-8930, BE-8940	
BE-8986	
BE-9770x 9	
BE-9785x 13	
MTC-5-16-C1	
1-170-08-2-2	
1-210-08-2-2	
1-230-08-2-2	
208	
2484T-30, 2484T-60	
2509	
2535L	
319	
3625N-32	
3681-16	
3734-2, 3734-3, 3734-4, 3734-5, 3734-6, 3734-8	
3735-4-120, 3735-5-120	
3740-150, 3740-250	
3906-300-32-5Px 5	
479-08	
481-1000, 481-400	
5515T	
782-U	
KBGU-5P-DISPENx 5	
KERU-01	
111M-10, 111M-11, 111M-12, 111M-13, 111M-14, 111M-15, 111M-16, 111M-17, 111M-18, 111M-19, 111M-20, 111M-21, 111M-22, 111M-23, 111M-24, 111M-25, 111M-26, 111M-27, 111M-28, 111M-29, 111M-30, 111M-32, 111M-33, 111M-34, 111M-36, 111M-6, 111M-7, 111M-8, 111M-9	
1RM-10, 1RM-11, 1RM-12, 1RM-13, 1RM-14, 1RM-15, 1RM-16, 1RM-17, 1RM-18, 1RM-19, 1RM-21, 1RM-22, 1RM-24, 1RM-27, 1RM-30, 1RM-32, 1RM-6, 1RM-7, 1RM-8, 1RM-9	
4040M-10-11, 4040M-12-13, 4040M-14-15, 4040M-16-17, 4040M-18-19, 4040M-8-9	
8069, 8071, 8073	

Tool Trolley General Purpose Tool Kit - 758 pcs



MONSTER



1370 x 501 x 1100 mm

1 MONSTER

FF1BSET-MONSTER

Tool Trolley Auto Repair Tool Kit - 357 pcs



AUTO



976 x 510 x 820 mm

1 AUTO

FF1ASET-AUTO

Tool Trolley General Purpose Tool Kit - 158 pcs



BASIC1



952 x 510 x 782 mm

1 BASIC

FF1ASET-BASIC

Tool Trolley General Purpose Tool Kit - 560 pcs



XLARGE



1360 x 510 x 820 mm

1 XLARGE

FF1ASET-XLARGE

Tool Trolley General Purpose Tool Kit - 346 pcs



LARGE



952 x 510 x 782 mm

1 LARGE

FF1ASET-LARGE

Tool Trolley General Purpose Tool Kit - 187 pcs



1475KXL6CBK-FF6



986 x 501 x 1100 mm

1 1475KXL6CBK-FF6

FF1A65



FF1A66



FF1A67



FF1A68



FF1A194



Tool Trolley General Purpose Tool Kit - 210 pcs



1475KXL6CBK-FF5



986 x 501 x 1100 mm

1 1475KXL6CBK-FF5

FF1A48		
FF1A49		
FF1A50		
FF1A51		
FF1A213		
FF1A53		

26" E77 Premium Storage HUB Tool Trolleys with 9 Drawers



1477K9



976 x 510 x 820 mm
 976 x 510 x 820 mm
 976 x 510 x 820 mm
 976 x 510 x 820 mm
 976 x 510 x 820 mm

1 1477K9
 1 1477K9BLACK
 1 1477K9GREY
 1 1477K9WHITE
 1 1477K9RED

26" E77 Premium Storage HUB Tool Trolleys with 8 Drawers



1477K8



976 x 510 x 820 mm
 976 x 510 x 820 mm

1 1477K8
 1 1477K8BLACK



976 x 510 x 820 mm
 976 x 510 x 820 mm
 976 x 510 x 820 mm

1 1477K8GREY
 1 1477K8WHITE
 1 1477K8RED

26" E77 Premium Storage HUB Tool Trolleys with 7 Drawers



1477K7



976 x 510 x 820 mm
 976 x 510 x 820 mm
 976 x 510 x 820 mm
 976 x 510 x 820 mm
 976 x 510 x 820 mm

1 1477K7
 1 1477K7BLACK
 1 1477K7GREY
 1 1477K7WHITE
 1 1477K7RED

26" E77 Premium Storage HUB Tool Trolleys with 6 Drawers



1477K6



976 x 510 x 820 mm
 976 x 510 x 820 mm
 976 x 510 x 820 mm
 976 x 510 x 820 mm
 976 x 510 x 820 mm

1 1477K6
 1 1477K6BLACK
 1 1477K6GREY
 1 1477K6WHITE
 1 1477K6RED

Premium E87 Storage HUB Top Chests with 4-Drawers



1487K4



402 x 510 x 692 mm
 402 x 510 x 692 mm
 402 x 510 x 692 mm

1 1487K4
 1 1487K4BLACK
 1 1487K4GREY

Premium E87 Storage HUB Top Chests on Wheels with 4 Drawers



1487K4W



564 x 510 x 692 mm
 564 x 510 x 692 mm

1 1487K4W
 1 1487K4BKW

26" E72 Storage HUB Tool Trolleys with 8 Drawers



1472K8



952 x 510 x 782 mm
 952 x 510 x 782 mm
 952 x 510 x 782 mm
 952 x 510 x 782 mm
 952 x 510 x 782 mm
 952 x 510 x 782 mm

1 1472K8
 1 1472K8BLACK
 1 1472K8GREY
 1 1472K8WHITE
 1 1472K8RED
 1 1472K8BLUE

26" E72 Storage HUB Tool Trolleys with 7 Drawers



1472K7



952 x 510 x 782 mm	1	1472K7
952 x 510 x 782 mm	1	1472K7BLACK
952 x 510 x 782 mm	1	1472K7GREY
952 x 510 x 782 mm	1	1472K7WHITE
952 x 510 x 782 mm	1	1472K7RED
952 x 510 x 782 mm	1	1472K7BLUE

26" E72 Storage HUB Tool Trolleys with 5 Drawers



1472K5



952 x 510 x 782 mm	1	1472K5
952 x 510 x 782 mm	1	1472K5BLACK
952 x 510 x 782 mm	1	1472K5GREY
952 x 510 x 782 mm	1	1472K5WHITE
952 x 510 x 782 mm	1	1472K5RED
952 x 510 x 782 mm	1	1472K5BLUE

26" E72 Storage HUB Top Chests with 4 Drawers



1482K4W



542 x 515 x 699 mm	1	1482K4W
542 x 515 x 699 mm	1	1482K4BKW

26" E72 Storage HUB Tool Trolleys with 6 Drawers



1472K6



952 x 510 x 782 mm	1	1472K6
952 x 510 x 782 mm	1	1472K6BLACK
952 x 510 x 782 mm	1	1472K6GREY
952 x 510 x 782 mm	1	1472K6WHITE
952 x 510 x 782 mm	1	1472K6RED
952 x 510 x 782 mm	1	1472K6BLUE

26" E72 Storage HUB Top Chests with 4 Drawers



1482K4



386 x 510 x 692 mm	1	1482K4
386 x 510 x 692 mm	1	1482K4BLACK
386 x 510 x 692 mm	1	1482K4GREY
386 x 510 x 692 mm	1	1482K4WHITE
386 x 510 x 692 mm	1	1482K4RED
386 x 510 x 692 mm	1	1482K4BLUE

Top Tool Panels for 1477K Storage HUB Tool Trolleys



1477K-AC12



396 x 25 x 610 mm	1	1477K-AC12
-------------------	---	------------

26" E72 Storage HUB Top Chests on Wheels with 5 Drawers



1482K5W



542 x 515 x 699 mm	1	1482K5W
--------------------	---	---------

Top Side Tool Panels for 1477K Storage HUB Tool Trolleys



1477K-AC13



400 x 25 x 365 mm	1	1477K-AC13
-------------------	---	------------



Work Document Boards for 1477K Storage HUB Tool Trolleys



1477K-AC14



327 x 25 x 240 mm

1 1477K-AC14

Jacket Holders for 1477K Storage HUB Tool Trolleys



1477K-AC17



68 x 65 x 435 mm

1 1477K-AC17

Spray Canister Holders for 1477K and 1472K Storage HUB Tool Trolleys



1477K-AC20



125 x 105 x 307 mm

1 1477K-AC20

Laptop Boards for 1477K Storage HUB Tool Trolleys



1477K-AC15



80 x 298 x 424 mm

1 1477K-AC15

Roll Holders for 1477K and 1472K Storage HUB Tool Trolleys



1477K-AC18



33 x 265 x 313 mm

1 1477K-AC18

Power Tool Holders for 1477K and 1472K Storage HUB Tool Trolleys



1477K-AC21



115 x 175 x 302 mm

1 1477K-AC21

Windshield Supports for 1477K Storage HUB Tool Trolleys



1477K-AC16



106 x 115 x 208 mm

1 1477K-AC16

Document Holders for 1477K and 1472K Storage HUB Tool Trolleys



1477K-AC19



241 x 65 x 300 mm

1 1477K-AC19

Side Tool Panels for 1477K and 1472K Storage HUB Tool Trolleys



1477K-AC22



659 x 18 x 300 mm

1 1477K-AC22

Folding Tray for 1472K and 1477K Trolleys



1477K-AC30



22 x 430 x 460 mm

1 1477K-AC30

Pin Code Locking Systems for 1477K Storage HUB Tool Trolleys



1477K-AC24



135 x 36 x 62 mm

1 1477K-AC24

Wooden Top Middle Parts for 1477K & 1487K Storage HUB Tool Trolleys



1477K-ACTW



20 x 510 x 550 mm

1 1477K-ACTW

Removable Drawer Dividers for 1477K Storage HUB Tool Trolleys



1477K-AC26



48 x 2 x 147 mm 0.07 kg

1 1477K-AC26

Mifare Locking Systems for 1477K Storage HUB Tool Trolleys



1477K-AC25



135 x 36 x 62 mm

1 1477K-AC25

Composite Bench Tops for 1477K Storage HUB Tool Trolley



1477K-ACTP



20 x 510 x 550 mm

1 1477K-ACTP

Bottom Drawers for 1477K Storage HUB Tool Trolleys



1477K-AC10



110 x 390 x 495 mm

1 1477K-AC10

Stainless Steel Top Middle Parts for 1477K & 1487K Storage HUB Tool Trolleys



1477K-ACTSS



20 x 510 x 550 mm

1 1477K-ACTSS

MDF Top Middle Parts for 1477K Storage HUB Tool Trolleys



1477K-ACTD



20 x 510 x 550 mm

1 1477K-ACTD



Stainless Steel Tops for 1472K & 1482K Storage HUB Tool Trolley



1472K-ACTSS



30 x 501 x 682 mm

1 1472K-ACTSS

53" Tool Trolleys with 7 Drawers



1476KXXL7BK



986 x 501 x 1430 mm

1 1476KXXL7BK

40" Classic C75 Tool Trolleys with 12 Drawers



1475KXXL12



986 x 501 x 1100 mm
986 x 501 x 1100 mm
986 x 501 x 1100 mm

1 1475KXXL12
1 1475KXXL12BLACK
1 1475KXXL12RED

Chestnut Wood Tops for 1472K & 1482K Storage HUB Tool Trolley



1472K-ACTW



30 x 501 x 680 mm

1 1472K-ACTW

53" Double Bank Tool Trolleys with 12 Drawers



1471KXXL12BKTS



1016 x 501 x 1440 mm

1 1471KXXL12BKTS

40" Classic C75 Tool Trolleys with 8 Drawers



1475KXXL8



986 x 501 x 1100 mm
986 x 501 x 1100 mm
986 x 501 x 1100 mm
986 x 501 x 1100 mm

1 1475KXXL8
1 1475KXXL8BLACK
1 1475KXXL8BLUE
1 1475KXXL8RED

MDF Tops for 1472K & 1482K Storage HUB Tool Trolley



1472K-ACTD



30 x 501 x 682 mm

1 1472K-ACTD

53" Special Tool Trolley with 8 Drawers and Side Cabinet



1475KXXL8CWTSS



1218 x 500 x 1505 mm 1089 kg

1 1475KXXL8CWTSS

40" Classic C75 Tool Trolleys with 7 Drawers



1475KXXL7



986 x 501 x 1100 mm
986 x 501 x 1100 mm
986 x 501 x 1100 mm
986 x 501 x 1100 mm

1 1475KXXL7
1 1475KXXL7BLACK
1 1475KXXL7BLUE
1 1475KXXL7RED

40" Classic C75 Tool Trolleys with 6 Drawers



1475KXL6

986 x 501 x 1100 mm	1	1475KXL6
986 x 501 x 1100 mm	1	1475KXL6BLACK
986 x 501 x 1100 mm	1	1475KXL6BLUE
986 x 501 x 1100 mm	1	1475KXL6RED

26" Classic C75 Tool Trolleys with 8 Drawers



1475K8

956 x 501 x 763 mm	1	1475K8
956 x 501 x 763 mm	1	1475K8BLACK
956 x 501 x 763 mm	1	1475K8BLUE
956 x 501 x 763 mm	1	1475K8RED

26" Low Height Tool Trolleys with 7 Drawers



1470K7LH

755 x 501 x 760 mm	1	1470K7LH
755 x 501 x 760 mm	1	1470K7LHBLUE
755 x 501 x 760 mm	1	1470K7LHGREY
755 x 501 x 760 mm	1	1470K7LHRED

40" Classic C75 Tool Trolleys with 6 Drawers and Side Cabinet



1475KXL6C

986 x 501 x 1100 mm	1	1475KXL6C
986 x 501 x 1100 mm	1	1475KXL6CBLACK

26" Classic C75 Tool Trolleys with 7 Drawers



1475K7

956 x 501 x 763 mm	1	1475K7
956 x 501 x 763 mm	1	1475K7BLACK
956 x 501 x 763 mm	1	1475K7BLUE
956 x 501 x 763 mm	1	1475K7RED

26" Classic C85 Top Chests with 4 Drawers



1485K4

417 x 500 x 677 mm	1	1485K4
417 x 500 x 677 mm	1	1485K4BLACK
417 x 500 x 677 mm	1	1485K4BLUE
417 x 500 x 677 mm	1	1485K4RED

40" Classic C85 Top Chests with 4 Drawers



1485KXL4

417 x 500 x 1016 mm	1	1485KXL4
417 x 500 x 1016 mm	1	1485KXL4BLACK
417 x 500 x 1016 mm	1	1485KXL4BLUE
417 x 500 x 1016 mm	1	1485KXL4RED

26" Classic C75 Tool Trolleys with 6 Drawers



1475K6

956 x 501 x 763 mm	1	1475K6
956 x 501 x 763 mm	1	1475K6BLACK
956 x 501 x 763 mm	1	1475K6BLUE
956 x 501 x 763 mm	1	1475K6RED

Stainless Steel Tops for 1475KXXL Tool Trolley



1475KXXL-ACTSS

45 x 495 x 1347 mm	1	1475KXXL-ACTSS



Chestnut Wood Tops for 1475KXXL Tool Trolley



1475KXXL-ACTW



45 x 495 x 1347 mm

1 1475KXXL-ACTW

Stainless Steel Tops for Tool Trolleys 40 mm



1470K-ACTSS



40 x 495 x 1010 mm
38 x 495 x 670 mm

1 1470KXL-ACTSS
1 1470K-ACTSS

Chestnut Tops for Tool Trolleys 40 mm



1470K-ACTW



40 x 500 x 1012 mm
40 x 497 x 674 mm

1 1470KXL-ACTW
1 1470K-ACTW

MDF Top for Tool Trolleys 40 mm



1470K-ACTD



40 x 495 x 1012 mm
40 x 497 x 674 mm

1 1470KXL-ACTD
1 1470K-ACTD

Side Cabinet with Lock for 1475KXL Trolley



1475KXL-AC20BK



820 x 503 x 419 mm

1 1475KXL-AC20BK

Foldable Trays for 1470 and 1475 Drawers



1470K-AC1



9 x 455 x 395 mm

1 1470K-AC1

Tool Holders for 23 Pcs Screwdrivers/Pry Bars

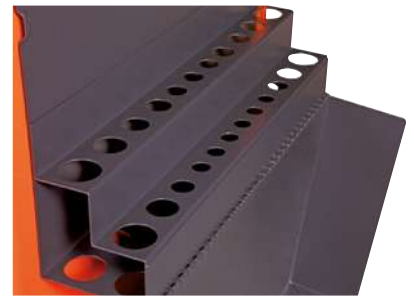

1470K-AC2



280 x 100 x 428 mm

1 1470K-AC2

Can Holders for 1470 and 1475 Drawers



1470K-AC3



140 x 90 x 457 mm

1 1470K-AC3

Document Holders for 1470 and 1475 Drawers



1470K-AC4



180 x 83 x 360 mm

1 1470K-AC4

Metallic Side Panels with Slots and Dots



1470K-ACSIDE



822 x 20 x 418 mm



1 1470K-ACSIDE

Tool Panels for 1475K 26" Trolleys



1470K-AC8



850 x 25 x 680 mm
850 x 25 x 680 mm



1 1470K-AC8
1 1470K-AC8GR

Three Tray Steel Roll Carts



1470KC3A



1051 x 435 x 764 mm



1 1470KC3A

26" ABS Tops for 26" Trolleys



1470K-AC7



45 x 497 x 674 mm



1 1470K-AC7

Metallic Adjustable Trays for Side Cabinet



1470KXLC-TRAY



470 x 10 x 310 mm



1 1470KXLC-TRAY

Two Tray Steel Roll Carts



1470KC2



1051 x 435 x 764 mm



1 1470KC2

Metallic Side Panels for 1495TP Hook System



1475K-ACSIDE



822 x 20 x 418 mm



1 1475K-ACSIDE

Multifunctional Two Tray Aluminium Roll Carts



1470KC5



1051 x 435 x 1381 mm
1051 x 435 x 1381 mm



1 1470KC5
1 1470KC5PC

Middle Trays for 1470KC2 Roll Cart



1470KCTRAY



750 mm



420 mm



1 1470KCTRAY



Folding Transport Trolleys with Aluminium Tray



1430FT120

1077 x 520 x 487 mm	6.4 kg	1	1430FT120

General Purpose 11 Foam Tool Kit - 758 pcs



FF1BSET-MONSTER

40 x 445 x 880 mm	1	FF1BSET-MONSTER

FF1B01LM	
FF1B02LM	
FF1B03LM	
FF1B04LM	
FF1B05LM	
FF1B10LM	
FF1B11LM	
FF1B08LM	
FF1B09LM	
FF1B06LM	
FF1B07LM	

Foam Inlay for 40" Trolley 1/4" Metric & Imperial Socket Sets - 141 pcs



FF1B01LM

35 x 445 x 880 mm	1	FF1B01LM

6700SM-10, 6700SM-11, 6700SM-12, 6700SM-13, 6700SM-14, 6700SM-4, 6700SM-4.5, 6700SM-5, 6700SM-5.5, 6700SM-6, 6700SM-7, 6700SM-8, 6700SM-9		
6700SZ-1/2, 6700SZ-1/8, 6700SZ-9/16, 6700SZ-1/4, 6700SZ-11/32, 6700SZ-3/16, 6700SZ-3/8, 6700SZ-5/16, 6700SZ-7/16, 6700SZ-7/32, 6700SZ-9/32, 6700SZ-5/32		
6700TORX-E4, 6700TORX-E5, 6700TORX-E6, 6700TORX-E7, 6700TORX-E8, 6700TORX-E10		
6950SL		
6962L, 6960, 6961		
6972H		
7400SM-10, 7400SM-11, 7400SM-12, 7400SM-13, 7400SM-14, 7400SM-15, 7400SM-16, 7400SM-17, 7400SM-18, 7400SM-19, 7400SM-20, 7400SM-21, 7400SM-22, 7400SM-6, 7400SM-7, 7400SM-8, 7400SM-9		
7400TORX-E10, 7400TORX-E11, 7400TORX-E12, 7400TORX-E14, 7400TORX-E16, 7400TORX-E18		
7406ZZ-16, 7406ZZ-21		
7409TORX-R-T27, 7409TORX-R-T30, 7409TORX-R-T40, 7409TORX-R-T45, 7409TORX-R-T50		
7409TORX-T25, 7409TORX-T27, 7409TORX-T30, 7409TORX-T40, 7409TORX-T45, 7409TORX-T50		
7750SL		
2058-BR		
8164-1/2		
A6800DM-10, A6800DM-12, A6800DM-13, A6800DM-4, A6800DM-5, A6800DM-5.5, A6800DM-6, A6800DM-7, A6800DM-8, A6800DM-9, A6800DM-11, A6800DM-14		
A6800DZ-9/16, A6800DZ-1/2, A6800DZ-1/4, A6800DZ-11/32, A6800DZ-3/16, A6800DZ-3/8, A6800DZ-5/16, A6800DZ-7/16, A6800DZ-7/32, A6800DZ-9/32		
A7400DZ-1/2, A7400DZ-11/16, A7400DZ-3/4, A7400DZ-3/8, A7400DZ-5/8, A7400DZ-7/16, A7400DZ-17/32, A7400DZ-9/16, A7400DZ-19/32, A7400DZ-13/16, A7400DZ-7/8, A7400DZ-1/4, A7400DZ-5/16		
K6650-1/4-1P		
K6625-1/4-1P		
6954		

6956	
6963	
6966	
7760, 7761, 7762	
7764	
7765	
7766	
7409BH-4, 7409BH-5, 7409BH-6, 7409BH-8, 7409BH-10	
A7402DM-10, A7402DM-11, A7402DM-12, A7402DM-13, A7402DM-14, A7402DM-15, A7402DM-16, A7402DM-17, A7402DM-18, A7402DM-19, A7402DM-8, A7402DM-9	
K6650-3/8-1P	
7756	

Foam Inlay for 40" Trolley 1/2" Metric & Imperial Socket Sets - 76 pcs



FF1B02LM

40 x 445 x 880 mm	1	FF1B02LM

7800DM-10, 7800DM-11, 7800DM-12, 7800DM-13, 7800DM-14, 7800DM-15, 7800DM-16, 7800DM-17, 7800DM-18, 7800DM-19, 7800DM-20, 7800DM-21, 7800DM-22, 7800DM-24, 7800DM-27, 7800DM-30, 7800DM-32, 7800DM-34, 7800DM-36		
7800DZ-1, 7800DZ-1.1/16, 7800DZ-1.1/4, 7800DZ-1.1/8, 7800DZ-1.3/16, 7800DZ-1/2, 7800DZ-11/16, 7800DZ-13/16, 7800DZ-15/16, 7800DZ-25/32, 7800DZ-3/4, 7800DZ-3/8, 7800DZ-5/8, 7800DZ-7/16, 7800DZ-7/8, 7800DZ-9/16, 7800DZ-19/32		
7809M-10, 7809M-12, 7809M-14, 7809M-4, 7809M-5, 7809M-6, 7809M-7, 7809M-8		
8150SL		
SBS87		
K7801M-13, K7801M-15, K7801M-16, K7801M-17, K7801M-18, K7801M-19, K7801M-21, K7801M-22, K7801M-24		
K8160D-2		
K7806M-13, K7806M-14, K7806M-16, K7806M-17, K7806M-18, K7806M-19, K7806M-21, K7806M-22, K7806M-24		
7809M-5-100, 7809M-6-100, 7809M-7-100, 7809M-8-120, 7809M-10-140		
K6650-1/2-1P		
8160-3, 8160-5, 8160-10		
8171		
8166		

Foam Inlay for 40" Trolley Combination Spanner & Ratcheting Spanner Sets - 36 pcs



FF1B03LM



35 x 445 x 880 mm

1 FF1B03LM

111M-10, 111M-11, 111M-12, 111M-13, 111M-14, 111M-15, 111M-16, 111M-17, 111M-18, 111M-19, 111M-20, 111M-21, 111M-22, 111M-24, 111M-27, 111M-30, 111M-32, 111M-34, 111M-8, 111M-9



1RM-10, 1RM-11, 1RM-12, 1RM-13, 1RM-14, 1RM-15, 1RM-16, 1RM-17, 1RM-18, 1RM-19, 1RM-21, 1RM-22, 1RM-24, 1RM-27, 1RM-8, 1RM-9



Foam Inlay for 40" Trolley Combination Spanner, Flex-Head Spanners & Telescopic Mirror - 26 pcs



FF1B04LM



35 x 445 x 880 mm

1 FF1B04LM

1RM-30, 1RM-32



111Z-1, 111Z-1.1/16, 111Z-1.1/4, 111Z-1.1/8, 111Z-1/2, 111Z-11/16, 111Z-13/16, 111Z-15/16, 111Z-3/4, 111Z-3/8, 111Z-5/16, 111Z-5/8, 111Z-7/16, 111Z-7/8, 111Z-9/16



4040M-10-11, 4040M-12-13, 4040M-14-15, 4040M-16-17, 4040M-18-19, 4040M-8-9



5515T



BLTS7P



2535L



Foam Inlay for 40" Trolley Pliers, Compact Pliers, Spanners & Calipers - 32 pcs



FF1B05LM



35 x 445 x 880 mm

1 FF1B05LM

1150-1/2H/P

1520 G

1620

2101S-160



21HDG-160



2223 S-150



2430 G-160



2430 S-200



2628 G-180



2628 S-180



2744



426TOR9



KBGU-10P-DISPEN



KERU-01



MTC-5-16-C1



8224



9029, 9031



806-1-3



C3330R



C3530



C3230



C3640



Foam Inlay for 40" Trolley ERGO™ Insulated and Precision Screwdriver Sets - 88 pcs



FF1B06LM



40 x 445 x 880 mm

1 FF1B06LM

700-2.5-50, 700-2-50, 700-3-50



701-00-50, 701-0-50, 701-1-75



703-10-50, 703-15-75, 703-6-50, 703-7-50, 703-8-50, 703-9-50



808050L



BE-8010S



BE-8020, BE-8040



BE-8040SL, BE-8050SL



BE-8150, BE-8155, BE-8256



BE-8355



BE-8600, BE-8611, BE-8621, BE-8623



BE-8600S



BE-8602



BE-8610SL, BE-8620SL



BE-8702, BE-8725



BE-8820SL



BE-8870



BE-8975B



BE-9777B



BE-9787



BE-9770



BE-9785



Foam Inlay for 40" Trolley ERGO™ Screwdrivers & Bit Sets - 169 pcs



FF1B07LM



40 x 445 x 880 mm

1 FF1B07LM

BE-8256TB, BE-8258TB



BE-8620TB, BE-8623TB



59/S100BC



7455-200



BE-8907, BE-8908, BE-8909, BE-8910, BE-8915, BE-8920, BE-8925, BE-8927, BE-8930, BE-8940



BE-8811, BE-8821



BE-8830



BE-8802



BE5049T



BE-7607



Foam Inlay for 40" Trolley Striking, Filing & Extracting Sets - 45 pcs



FF1B08LM

40 x 445 x 880 mm 1 FF1B08LM

1-100-08-2-2	
1-170-08-2-2	
1-210-08-2-2	
1-230-08-2-2	
1435/5	
2484-30, 2484-45, 2484-60	
3734-2, 3734-3, 3734-4, 3734-5, 3734-6, 3734-8	
3735-4-120, 3735-5-120	
3740-150, 3740-250	
4543-3	
4611-3	
481-400	
7865	
3625N-32	
1418-4, 1418-5, 1418-6, 1418-7.5	

Foam Inlay for 40" Trolley Hexagonal T-Handle, Multi-Position Pry Bars & Feeler Gauges Sets - 21 pcs



FF1B09LM

35 x 445 x 880 mm 1 FF1B09LM

900T-025-100, 900T-030-100, 900T-040-150, 900T-050-150, 900T-060-200, 900T-080-200	
901T-010-100, 901T-015-150, 901T-020-150, 901T-025-150, 901T-027-150, 901T-030-200, 901T-040-200	
BE256-155, BE256-178, BE256-250	
BE66152	
BT10P325, BT10P330, BT10P338	
1544	

Foam Inlay for 40" Trolley Hand Hacksaw, Circip Pliers & Grips - 20 pcs



FF1B10LM

45 x 445 x 880 mm 1 FF1B10LM

2633/S4	
2800-140, 2800-180	
2890-125, 2890-180	
2900-140, 2900-180	
2951-180	
2952-165	
2963-280	
2965-200	
2990-125, 2990-180	
BE-8986	
325	
2681	
CR B 02	

Foam Inlay for 40" Trolley Metal Clips for 1/4", 3/8", 1/2" Sockets & 3/4" Sockets Set - 104 pcs



FF1B11LM

50 x 445 x 880 mm 1 FF1B11LM

RAIL-264	
CLIPS-1/4	
CLIPS-3/8	
CLIPS-1/2	
SLX 17	

General Purpose 12 Foam Tool Kit - 560 pcs



FF1ASET-XLARGE

40 x 543 x 445 mm 1 FF1ASET-XLARGE

FF1A195LM	
FF1A196LM	
FF1A197LM	
FF1A198LM	
FF1A199LM	
FF1A200LM	
FF1A201LM	
FF1A202LM	
FF1A203LM	
FF1A204LM	
FF1A205LM	
FF1A206LM	

General Purpose 6 Foam Tool Kit - 346 pcs



FF1ASET-LARGE

40 x 543 x 445 mm 1 FF1ASET-LARGE

FF1A207LM	
FF1A208LM	
FF1A209LM	
FF1A210LM	
FF1A211LM	
FF1A212LM	

General Purpose 3 Foam Tool Kit - 158 pcs



FF1ASET-BASIC



40 x 543 x 445 mm

1 FF1ASET-BASIC

FF1A214LM

FF1A215LM

FF1A216LM

MRO 7 Foam Toolkit - 256 Pcs



FF1ASET-MRO2



530 x 600 x 800 mm

1 FF1ASET-MRO2

FF1A130

FF1A131

FF1A132

FF1A133

FF1A134

FF1A135

FF1A136

MRO 5 Foam Toolkit - 188 Pcs



FF1ASET-MRO3



530 x 600 x 800 mm

1 FF1ASET-MRO3

FF1A138

FF1A134

FF1A139

FF1A141

FF1A137

MRO 4 Foam Toolkit - 147 Pcs



FF1ASET-MRO4



530 x 600 x 800 mm

1 FF1ASET-MRO4

FF1A143

FF1A145

FF1A134

FF1A142

MRO 3 Foam Toolkit - 84 Pcs



FF1ASET-MRO5



530 x 600 x 800 mm

1 FF1ASET-MRO5

FF1A147

FF1A146

FF1A134

Auto Repair 8 Foam Tool Kit - 357 pcs



FF1ASET-AUTO



40 x 543 x 445 mm

1 FF1ASET-AUTO

FF1A218LM

FF1A219LM

FF1A220LM

FF1A221LM

FF1A222LM

FF1A223LM

FF1A224LM

FF1A225LM

Auto Repair 5 Foam Toolkit - 196 Pcs



FF1ASET-AUTO1



50 x 543 x 445 mm

1 FF1ASET-AUTO1

FF1A19

FF1A20

FF1A21

FF1A23

FF1A22



Auto Repair 4 Foam Toolkit - 168 Pcs



FF1ASET-AUTO2



50 x 543 x 445 mm

1 FF1ASET-AUTO2

FF1A19	
FF1A24	
FF1A21	
FF1A25	

Auto Repair 3 Foam Toolkit - 140 Pcs



FF1ASET-AUTO3



50 x 543 x 445 mm

1 FF1ASET-AUTO3

FF1A28	
FF1A26	
FF1A27	

Auto Repair 4 Foam Toolkit - 177 Pcs



FF1ASET-AUTO6



50 x 543 x 445 mm

1 FF1ASET-AUTO6

FF1A19	
FF1A72	
FF1A70	
FF1A71	

Auto Repair 2 Foam Tool Kit - 62 pcs



FF1ASET-AUTO-M1



50 x 543 x 445 mm

1 FF1ASET-AUTO-M1

BP910	
BP909TH	
BE-9678	
BE-9675	
29M-30	
2997-250	
1995LM-9, 1995LM-8, 1995LM-6	
3750	
1177-SCRIBE	
K7801M-9, K7801M-10, K7801M-11, K7801M-12, K7801M-13, K7801M-14, K7801M-15, K7801M-16, K7801M-17, K7801M-18, K7801M-19, K7801M-21, K7801M-22, K7801M-23, K7801M-24, K7801M-30, K7801M-32	
K7806M-15, K7806M-21, K7806M-24, K7806M-27	
K8901M-32, K8901M-34, K8901M-36	
K8964D	
K8167S	

K8160D-3

2800-150

2900-150

3734S/6

BE-8258TB

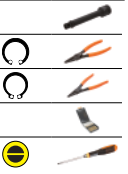

Auto Repair 2 Foam & SAC Alignment Tool Kit - 54 pcs



FF1ASET-AUTO-M2



60 x 543 x 445 mm

1 FF1ASET-AUTO-M2

BE301	
K7801TORX-E10, K7801TORX-E12, K7801TORX-E14, K7801TORX-E16, K7801TORX-E18, K7801TORX-E20	
K8160D-2	
BE301CM	
BWHEPSSH8	
BE51038, BE510310, BE510312	
BP822	
BP825	

Auto Repair 2 Foam Tool Kit - 34 pcs



FF1ASET-AUTO-M3



40 x 543 x 445 mm

1 FF1ASET-AUTO-M3

BE1GP5T	
6968	
BE1SP1F	
BE6OF108	
BE6307414F	
BE6OFW	

BE1FFWF	
BE63064514F1	
BE6810Z, BE6810	
BE6FCP	
52	
1546	
5515M	
BE1P	
7455-60	
BE1FLD2, BE1FLD1, BE1FLD3	
BE65F65120	
7764	
8164-1/2	
BE6302712F	
6962-W	
6954	
BE6701VAG	
BE62110	
BE1310P427	
7406ZZ-21, 7406ZZ-16	
BE1SP14L	
BE1GP5	
2421GC-160IP	
8166	

Auto Repair 2 Foam Tool Kit - 32 pcs



FF1ASET-AUTO-M5

45 x 543 x 445 mm 1 FF1ASET-AUTO-M5

319	
484-1000	
SB3654BM-20	
3625S-44	
B192.004.200	
BE-8258TB	
2484/S4	
6225D	
B194.030.150, B194.025.125, B194.020.100, B194.010.075	
600.005.012	
BBS165	
K7801TORX-E10, K7801TORX-E12, K7801TORX-E14, K7801TORX-E16, K7801TORX-E18, K7801TORX-E20, K7801TORX-E24	
BBR203P920, BBR203P925, BBR203P930, BBR203P940, BBR203P945, BBR203P950, BBR203P955, BBR203P960	

Auto Repair 2 Foam Tool Kit - 23 pcs



FF1ASET-AUTO-M4

60 x 543 x 445 mm 1 FF1ASET-AUTO-M4

BS618	
4545-N1, 4545-N11	
4545-1, 4545-2	
MTB-3-16	
361-14	
8900SM-41	
BS52	
747-22, 747-21, 747-19, 747-17, 747-15, 747-14, 747-13, 747-12	
BS40VAG	
BS56	
BS100PSA1	
BS45BMW	
8157-24	
8171	

Auto Repair 2 Foam Tool Kit - 42 pcs



FF1ASET-AUTO-M6

40 x 543 x 445 mm 1 FF1ASET-AUTO-M6

FM10	
782-U	

BBR405	
BBR400	
BBR210P3	
BBR6131	
BBR204	
BBR1501	
BBR501011, BBR50121314	
2900-215	
7823	
BBR100	
1154	
6M-16-17, 6M-14-15	
1949M-17-19, 1949M-12-13, 1949M-10-11, 1949M-8-9	

Fit&Go 3/3 Foam Laser Marked Inlay 1/2" & 1/4" Socket Set & Bit Set - 139 pcs



FF1A195LM

40 x 445 x 543 mm 1 FF1A195LM

A6800DZ-9/16, A6800DZ-1/2, A6800DZ-1/4, A6800DZ-11/32, A6800DZ-3/16, A6800DZ-3/8, A6800DZ-5/16, A6800DZ-7/16, A6800DZ-7/32, A6800DZ-9/32	
K6625-1/4-1P	
K6650-1/4-1P	
6954	
6963	
K6650-3/8-1P	
7767	
8167	
2058-BR	
59/S31B	
SL25L	
S330L	



Fit&Go 3/3 Foam Laser Marked Inlay 1/2" Socket Set & 1/2" Deep Socket Set - 67 pcs



FF1A196LM

40 x 445 x 543 mm 1 FF1A196LM

- 7800DZ-1.1/16, 7800DZ-1.1/4, 7800DZ-1.1/8, 7800DZ-1.3/16, 7800DZ-1/2, 7800DZ-11/16, 7800DZ-13/16, 7800DZ-15/16, 7800DZ-25/32, 7800DZ-3/4, 7800DZ-3/8, 7800DZ-5/8, 7800DZ-7/16, 7800DZ-7/8, 7800DZ-9/16, 7800DZ-19/32
- 7809M-10, 7809M-12, 7809M-14, 7809M-4, 7809M-5, 7809M-6, 7809M-7, 7809M-8
- 7809M-5-100, 7809M-6-100, 7809M-7-100, 7809M-8-120, 7809M-10-140
- K6650-1/2-1P
- S1612L
- 8967
- S240

Fit&Go 3/3 Foam Laser Marked Inlay 1/2" Impact Socket Set, Cutting & Measuring - 36 pcs



FF1A197LM

40 x 445 x 543 mm 1 FF1A197LM

- 1150-1/2H/P
- 2744
- 426TOR9
- K7801M-13, K7801M-15, K7801M-16, K7801M-17, K7801M-18, K7801M-19, K7801M-21, K7801M-22, K7801M-24
- K8160D-2
- K7806M-13, K7806M-14, K7806M-16, K7806M-17, K7806M-18, K7806M-19, K7806M-21, K7806M-22, K7806M-24
- KBGU-10P-DISPEN

- KERU-01
- MTC-5-16-C1
- 325
- 1544

Fit&Go 3/3 Foam Laser Marked Inlay Combination Spanners Set - 20 pcs



FF1A198LM

35 x 445 x 543 mm 1 FF1A198LM

- 111M-10, 111M-11, 111M-12, 111M-13, 111M-14, 111M-15, 111M-16, 111M-17, 111M-18, 111M-19, 111M-20, 111M-21, 111M-22, 111M-24, 111M-27, 111M-30, 111M-32, 111M-34, 111M-8, 111M-9

Fit&Go 3/3 Foam Laser Marked Inlay Adjustable, Ratcheting & Swivel Head Spanners Set - 23 pcs



FF1A199LM

35 x 445 x 543 mm 1 FF1A199LM

- 1RM-10, 1RM-11, 1RM-12, 1RM-13, 1RM-14, 1RM-15, 1RM-16, 1RM-17, 1RM-18, 1RM-19, 1RM-21, 1RM-22, 1RM-24, 1RM-8, 1RM-9
- 4040M-10-11, 4040M-12-13, 4040M-14-15, 4040M-16-17, 4040M-18-19, 4040M-8-9
- 9029, 9031

Fit&Go 3/3 Foam Laser Marked Inlay Pipe Wrench, Holding, Cutting & Circlip Pliers - 14 pcs



FF1A200LM

35 x 445 x 543 mm 1 FF1A200LM

- 1520 G
- 1620
- 2101G-160
- 2223 S-150
- 2233 D-160
- 2430 G-190HD
- 2628 G-180
- 2890-180
- 2990-180
- C3330R
- C3530
- C3230
- C3640
- 8224

Fit&Go 3/3 Foam Laser Marked Inlay ERGO™ Screwdrivers, Precision Screwdrivers & L-Keys - 37 pcs



FF1A201LM

40 x 445 x 543 mm 1 FF1A201LM

- BE-8256TB
- BE-8620TB, BE-8623TB
- 700-2-50
- 701-00-50, 701-0-50, 701-1-75
- 703-10-50, 703-15-75, 703-6-50, 703-7-50, 703-8-50, 703-9-50
- BE-8040SL
- BE-8040

BE-8150, BE-8155, BE-8256		
BE-8355		
BE-8600, BE-8611, BE-8621, BE-8623		
BE-8602		
BE-8811, BE-8821		
BE-8802		
BE-8870		
BE-9787		

Fit&Go 3/3 Foam Laser Marked Inlay ERGO™ Screwdrivers, T-Handle Screwdrivers & L-Keys - 39 pcs



FF1A202LM

40 x 445 x 543 mm 1 FF1A202LM

900T-025-100, 900T-030-100, 900T-040-150, 900T-050-150, 900T-060-200, 900T-080-200		
BE-8907, BE-8908, BE-8909, BE-8910, BE-8915, BE-8920, BE-8925, BE-8927, BE-8930		
BE-8702, BE-8725		
BE-9770		
BE-9785		

Fit&Go 3/3 Foam Laser Marked Inlay Ratcheting Screwdrivers, T-Handle Screwdrivers & Bit Set - 114 pcs



FF1A203LM

40 x 445 x 543 mm 1 FF1A203LM

59/S100BC		
808050L		
2058-BR		
901T-010-100, 901T-015-150, 901T-020-150, 901T-025-150, 901T-027-150, 901T-030-200, 901T-040-200		

Fit&Go 3/3 Foam Laser Marked Inlay Striking & Files - 40 pcs



FF1A204LM

40 x 445 x 543 mm 1 FF1A204LM

1-100-08-2-2	
1-170-08-2-2	
1-210-08-2-2	
1-230-08-2-2	
1435/5	
3734-2, 3734-3, 3734-4, 3734-5, 3734-6, 3734-8	
3735-4-120, 3735-5-120	
3740-150, 3740-250	
481-400	
7865	
3625N-32	
1418-4, 1418-5, 1418-6, 1418-7.5	

Fit&Go 3/3 Foam Laser Marked Inlay Awls, Hooks, Inspection Mirrors & Rivet Gun - 14 pcs



FF1A205LM

35 x 445 x 543 mm 1 FF1A205LM

2484-45	
2633/S4	
2951-180	
5515T	
BE66152	
BE-8986	
BT10P330	
2681	
1450D-ISO	
806-1-3	
5515FL	

Fit&Go 3/3 Foam Laser Marked Inlay 3/4" Socket Set - 17 pcs



FF1A206LM

50 x 445 x 543 mm 1 FF1A206LM

SLX 17

Fit&Go 3/3 Foam Laser Marked Inlay 1/4" & 3/8" Socket Set, T-Handle Screwdrivers, Caliper & Bit Set - 192 pcs



FF1A207LM

40 x 445 x 543 mm 1 FF1A207LM

1150-1/2H/P	
59/S100BC	
808050L	
2058-BR	
K6650-1/4-1P	
6956	
6963	
K6650-3/8-1P	
8967/S3	
6966	
6954	
696EX-08	
904T-060-150	
905T-060-100	
6973A	
SL25L	
S330	



Fit&Go 3/3 Foam Laser Marked Inlay
Socket Set, 1/2" Impact Socket Set &
Cutting - 56 pcs



FF1A208LM



45 x 445 x 543 mm



1 FF1A208LM

2744

7809M-10, 7809M-12, 7809M-14,
7809M-4, 7809M-5, 7809M-6, 7809M-7,
7809M-8

K7801M-13, K7801M-15, K7801M-16,
K7801M-17, K7801M-18, K7801M-19,
K7801M-21, K7801M-22, K7801M-24

K8160D-2

KBGU-10P-DISPEN

KERU-01

319

K6650-1/2-1P

S240

Fit&Go 3/3 Foam Laser Marked Inlay
Combination Spanners & Magnetic Pick-
Up with LED Light - 56 pcs



FF1A209LM



35 x 445 x 543 mm



1 FF1A209LM

111M-10, 111M-11, 111M-12, 111M-13,
111M-14, 111M-15, 111M-16, 111M-17,
111M-18, 111M-19, 111M-20, 111M-21,
111M-22, 111M-24, 111M-27, 111M-30,
111M-32, 111M-34, 111M-8, 111M-9

2535L

Fit&Go 3/3 Foam Laser Marked Inlay
ERGO™ Screwdrivers, Spanners & Pliers - 24 pcs



ergo



FF1A210LM



40 x 445 x 543 mm



1 FF1A210LM

1RM-10, 1RM-11, 1RM-12, 1RM-13,
1RM-14, 1RM-15, 1RM-16, 1RM-17,
1RM-18, 1RM-19, 1RM-8, 1RM-9

1520 G

2101G-160

2430 G-190HD

2628 G-180

BE-8602

BE-8611, BE-8621

BE-8811, BE-8821

BE-8802

8224

9031

Fit&Go 3/3 Foam Laser Marked Inlay
ERGO™ Screwdrivers, T-Handle
Screwdrivers & L-Keys - 35 pcs



ergo



FF1A211LM



40 x 445 x 543 mm



1 FF1A211LM

900T-025-100, 900T-030-100, 900T-
040-150, 900T-050-150, 900T-060-200,
900T-080-200

BE-8910, BE-8915, BE-8920, BE-8925,
BE-8930

BE-8020, BE-8040

BE-8050SL

BE-8150, BE-8155

BE-8355

BE-9787

BE-9770

Fit&Go 3/3 Foam Laser Marked Inlay
ERGO™ Screwdrivers, T-Handle
Screwdrivers & L-Keys - 18 pcs



ergo



FF1A212LM



35 x 445 x 543 mm



1 FF1A212LM

1-100-08-2-2

1-210-08-2-2

1-230-08-2-2

3734-2, 3734-3, 3734-4, 3734-5, 3734-
6, 3734-8

3735-4-120

3740-150, 3740-250

426TOR9

481-400

BE-8986

MTC-5-16-C1

2446

3625N-32

Fit&Go 3/3 Foam Inlay 1/4" & 3/8" Socket
Set & Torque Wrench - 85 pcs



FF1A213



52 x 445 x 543 mm



1 FF1A213

8150SL

7800SM-8, 7800SM-9, 7800SM-12,
7800SM-13, 7800SM-10, 7800SM-11,
7800SM-30, 7800SM-32, 7800SM-24,
7800SM-22, 7800SM-23, 7800SM-27,
7800SM-16, 7800SM-17, 7800SM-14,
7800SM-15, 7800SM-21, 7800SM-18,
7800SM-19

7455-200

7809TORX-T45, 7809TORX-T40, 7809TORX-T30, 7809TORX-T20, 7809TORX-T25		
7809M-6, 7809M-5, 7809M-7, 7809M-10, 7809M-14, 7809M-12		
7809M-6-140, 7809M-5-180, 7809M-10- 140, 7809M-8-120		
6950SL		
6962-W, K6650-1/4-1P		
6960-W		
6968		
6700SM-9, 6700SM-10, 6700SM-7, 6700SM-8, 6700SM-13, 6700SM-14, 6700SM-11, 6700SM-12, 6700SM-4, 6700SM-6, 6700SM-5		
6709M-6, 6709M-8, 6709M-4, 6709M-5, 6709M-3		
A6709M-2.5, A6709M-5, A6709M-6, A6709M-3, A6709M-4		
6962L		
7400SM-17, 7400SM-18, 7400SM-15, 7400SM-16, 7400SM-19, 7400SM-9, 7400SM-10, 7400SM-7, 7400SM-8, 7400SM-13, 7400SM-14, 7400SM-11, 7400SM-12, 7400SM-6		
7760-W, 7761-W		
7750SL		
7768		
8160-5, 8160-10		
8166		

Fit&Go 3/3 Foam Laser Marked Inlay 1/4" & 1/2" Socket Set, Pliers & Bit Set - 91 pcs



FF1A214LM

40 x 445 x 543 mm 1 FF1A214LM

2058-BR		
K6650-1/4-1P		
6956		
6963		
K6650-1/2-1P		
SL25		
8072		
2971G-250		
806-1-3		
2171G-160		
59/S31B		
S240		

Fit&Go 3/3 Foam Laser Marked Inlay ERGO™ Screwdrivers & Combination Spanners - 31 pcs



FF1A215LM

40 x 445 x 543 mm 1 FF1A215LM

111M-10, 111M-11, 111M-12, 111M-13, 111M-14, 111M-15, 111M-16, 111M-17, 111M-18, 111M-19, 111M-20, 111M-21, 111M-22, 111M-24, 111M-8, 111M-9		
BE-8910, BE-8915, BE-8920, BE-8925, BE-8930		
BE-8020, BE-8040		
BE-8155		
BE-8355		
BE-8602		
BE-8611, BE-8621		
BE-8811, BE-8821		
BE-8802		

Fit&Go 3/3 Foam Laser Marked Inlay Striking, Cutting, Files & L-Keys - 36 pcs



FF1A216LM

40 x 445 x 543 mm 1 FF1A216LM

1-100-08-2-2		
1-210-08-2-2		
1-230-08-2-2		
3734-3, 3734-4, 3734-5		
3735-4-120		
481-400		
BE-8986		
BE-9770		
S4RM-8-11, S4RM-12-15, S4RM-16-19		
KB18-01		

KSBG18-10DISPEN

MTG-3-16		
WR2-MM		
3740-200		
317		

Fit&Go 3/3 Foam Laser Marked Inlay Window Click Torque Wrench, Spark Plug Sockets & 1/4" Socket Set - 79 pcs



FF1A218LM

45 x 445 x 543 mm 1 FF1A218LM

1178-SCRIBE		
1547		
74WR-200		
7805ZZ-16, 7805ZZ-21		
BBR201P64014, BBR201P64016, BBR201P64018, BBR201P67814, BBR201P67816, BBR201P67818		
BWSS12P3		
MTC-3-13-C1		
7800SM-34, 7800SM-36		
SL25L		
SR200-MM		
S240		

Fit&Go 3/3 Foam Laser Marked Inlay 1/2" Deep Socket & Socket Hex Bits Set - 49 pcs



FF1A219LM

35 x 445 x 543 mm 1 FF1A219LM

1-100-08-2-2		
S1612L		
S18HEX		
S18TORX		



Fit&Go 3/3 Foam Laser Marked Inlay Combination Spanner Set & Adjustable Spanner - 21 pcs



FF1A220LM



35 x 445 x 543 mm

1 FF1A220LM

111M-10, 111M-11, 111M-12, 111M-13, 111M-14, 111M-15, 111M-16, 111M-17, 111M-18, 111M-19, 111M-20, 111M-21, 111M-22, 111M-23, 111M-24, 111M-27, 111M-30, 111M-32, 111M-8, 111M-9

8071

Fit&Go 3/3 Foam Laser Marked Inlay Ratcheting Combination Spanner, Swivel Head Spanner & L-Keys Sets - 42 pcs



FF1A221LM



40 x 445 x 543 mm

1 FF1A221LM

1RM-10, 1RM-11, 1RM-12, 1RM-13, 1RM-14, 1RM-17, 1RM-19, 1RM-8

2681

4040M-10-11, 4040M-12-13, 4040M-14-15, 4040M-16-17, 4040M-18-19, 4040M-8-9

8045LVDE

806-1-1

808050

808050S

9715-14-250

BE-9575

BE-9770

Fit&Go 3/3 Foam Laser Marked Inlay ERGO™ Screwdrivers, Caliper, Bit Set & 1/2" Impact Socket Set - 65 pcs



FF1A222LM



45 x 445 x 543 mm

1 FF1A222LM

BE-7805, BE-7806, BE-7807, BE-7808, BE-7809, BE-7810, BE-7811, BE-7813, BE-7855

D/S14

K8160D-1, K8160D-2

K8167S

BE-8135TB, BE-8145TB, BE-8150TB, BE-8155TB

BE-8610TB, BE-8620TB, BE-8623TB

1150-1/2H/P

59/S31B

Fit&Go 3/3 Foam Laser Marked Inlay Pliers & T-Type Hex Key Spanners - 15 pcs



FF1A223LM



35 x 445 x 543 mm

1 FF1A223LM

5226 DC

158-N

158-NB

21HDG-200

2430 G-190HD

2628G-200IP

2968-190

8224 IP

BE1P

BE1TH-2.5, BE1TH-3, BE1TH-4, BE1TH-5, BE1TH-6, BE1TH-8

Fit&Go 3/3 Foam Laser Marked Inlay Striking, Cutting & Hose Clamp Set - 26 pcs



FF1A224LM



40 x 445 x 543 mm

1 FF1A224LM

1435/8

319

3625S-35

3734S/6

3735-5-150

3740-200

3750

3906-300-24-2P

479-16

KBFU-01

BE256P3

Fit&Go 3/3 Foam Laser Marked Inlay Awls, Hooks, Scraper, Magnetic Pick Up Tool & Torx Bits Set - 60 pcs



FF1A225LM



40 x 445 x 543 mm

1 FF1A225LM

2487

2535F1

2633/S4

2485

782-U

BE5049T

BE66152

2484-45

5515T-52

Fit&Go 3/3 Foam Inlay 1/4" + 1/2" Screwdriver/Socket Set - 77 Pcs



FF1A01



45 x 445 x 543 mm



1 FF1A01

A6800DM-4, A6800DM-5, A6800DM-6, A6800DM-7, A6800DM-8, A6800DM-9, A6800DM-10, A6800DM-11, A6800DM-12, A6800DM-13

6700SM-4.5, 6700SM-5, 6700SM-5.5, 6700SM-6, 6700SM-7, 6700SM-8, 6700SM-9, 6700SM-10, 6700SM-11, 6700SM-12, 6700SM-13, 6700SM-4

59S/22-1

6950SL

6954

6956

6960, 6961

6966

6972H

7800SM-18, 7800SM-19, 7800SM-10, 7800SM-11, 7800SM-12, 7800SM-13, 7800SM-14, 7800SM-15, 7800SM-16, 7800SM-17, 7800SM-22, 7800SM-27, 7800SM-24, 7800SM-30, 7800SM-32

7805ZZ-21

7807H

B191.040.100, B191.055.150

B192.001.100, B192.002.125

8150SL

8154-11

8160-3, 8160-10

8166

Fit&Go 3/3 Foam Inlay Combination and Double Open End Wrench Set - 19 Pcs



FF1A02



45 x 445 x 543 mm



1 FF1A02

111M-12, 111M-13, 111M-14, 111M-17, 111M-19, 111M-22, 111M-6, 111M-7, 111M-8, 111M-10

6M-6-7, 6M-8-9, 6M-10-11, 6M-12-13, 6M-14-15, 6M-16-17, 6M-18-19, 6M-20-22

808050L

Fit&Go 3/3 Foam Inlay Pliers/Striking/Measuring Toolset - 18 Pcs



FF1A03



50 x 445 x 543 mm



1 FF1A03

BE-9770

MTB-5-25

3734N-4-150, 3734N-6-150

1-100-08-2-2

2171G-160

2971G-250

481-400

2678 G-160

306

Fit&Go 3/3 Foam Inlay Adjustable/Combination/Double Open End Wrench Set - 30 Pcs



FF1A04



50 x 445 x 543 mm



1 FF1A04

S4RM-12-15, S4RM-16-19, S4RM-8-11

111M-30, 111M-32, 111M-6, 111M-7, 111M-8, 111M-9, 111M-10, 111M-11, 111M-12, 111M-13, 111M-14, 111M-15, 111M-16, 111M-17, 111M-18, 111M-19, 111M-21, 111M-22, 111M-24, 111M-27

6M-10-11, 6M-12-13, 6M-14-15, 6M-17-19, 6M-6-7, 6M-8-9

9071C

Fit&Go 3/3 Foam Laser Marked Inlay 1/2" & 1/4" Sockets Ratcheting Screwdriver & Bit Set - 104 pcs



FF1A051



50 x 445 x 543 mm



1 FF1A051

BE-9678

SBS60-4, SBS60-4.5, SBS60-5, SBS60-5.5, SBS60-6, SBS60-7, SBS60-8, SBS60-9, SBS60-10, SBS60-11, SBS60-12, SBS60-13, SBS60-14

SBS61

SBS63-2, SBS63-4, SBS63-6

SBS65

SBS67

SBS69

7800SM-10, 7800SM-11, 7800SM-12, 7800SM-13, 7800SM-14, 7800SM-15, 7800SM-16, 7800SM-18, 7800SM-19, 7800SM-21, 7800SM-17, 7800SM-22, 7800SM-24, 7800SM-27, 7800SM-32, 7800SM-30

SBS88

59S/31-1

6956

6972H

7809M-5, 7809M-6, 7809M-7, 7809M-8, 7809M-10, 7809M-12, 7809M-14, 7809M-17, 7809M-19

7809TORX-T20, 7809TORX-T25, 7809TORX-T27, 7809TORX-T30, 7809TORX-T40, 7809TORX-T45, 7809TORX-T50, 7809TORX-T55, 7809TORX-T60

808050

8150SL

8154-11

8160-W

8160-10

8166

6954



Fit&Go 3/3 Foam Inlay Screwdriver/Pliers Set - 23 Pcs



FF1A06

45 x 445 x 543 mm 1 FF1A06

BE-8020L, BE-8040		
BE-8150, BE-8255, BE-8256		
BE-8350		
BE-8601		
BE-8610, BE-8620		
BE-8910, BE-8915, BE-8920, BE-8925, BE-8927, BE-8930		
MTB-3-16		
2101G-160IP		
2427 G-200 IP		
2535L		
2628 G-160IP		
2951-180		
5515T-52		
8224 IP		

Fit&Go 3/3 Foam Inlay File/Striking Toolset with Hacksaw Frame - 15 Pcs



FF1A07

40 x 445 x 543 mm 1 FF1A07

3734N-3-150, 3734N-5-150, 3734N-6-150	
3735N-4-120	
3740-175	
SQZ150003	
1-100-08-2-2	
1-210-08-2-2	
1-230-08-2-2	
2744	
3625W-35	

3745-150	
481-400	
782-U	
317	

Fit&Go 3/3 Foam Inlay 1/4" + 1/2" + 3/8" Socket and Pear Head Ratchet Set - 138 Pcs



FF1A08

60 x 445 x 543 mm 1 FF1A08

A6800DM-5.5, A6800DM-6, A6800DM-7, A6800DM-8, A6800DM-9, A6800DM-10, A6800DM-11, A6800DM-12, A6800DM-13	
A7402DM-10, A7402DM-11, A7402DM-12, A7402DM-13, A7402DM-14, A7402DM-15, A7402DM-16, A7402DM-17, A7402DM-18, A7402DM-19	
1544	
2058-BR	
6700SM-5.5, 6700SM-6, 6700SM-7, 6700SM-8, 6700SM-9, 6700SM-10, 6700SM-11, 6700SM-12, 6700SM-13	
6709M-3, 6709M-4, 6709M-5, 6709M-6, 6709M-8	
6709PH-1, 6709PH-2, 6709PH-3	
6709TORX-T20, 6709TORX-T25, 6709TORX-T27, 6709TORX-T30, 6709TORX-T40, 6709TORX-T8, 6709TORX-T9, 6709TORX-T10, 6709TORX-T15	
6950SL	
6954	
6956	
6958	
6960, 6961, 6962, 6962L	
6966	
6972H	
7400SM-6, 7400SM-7, 7400SM-8, 7400SM-9, 7400SM-10, 7400SM-11, 7400SM-12, 7400SM-13, 7400SM-14, 7400SM-15, 7400SM-16, 7400SM-17, 7400SM-18, 7400SM-19, 7400SM-22	
7407H	
7409M-3, 7409M-4, 7409M-5, 7409M-6, 7409M-7, 7409M-8, 7409M-10	
7409TORX-T25, 7409TORX-T27, 7409TORX-T30, 7409TORX-T40, 7409TORX-T45, 7409TORX-T50	
7750SL	
7754	
7758	
7760, 7761, 7762	
7764	
7765	

7766	
7800SM-10, 7800SM-11, 7800SM-12, 7800SM-13, 7800SM-14, 7800SM-15, 7800SM-16, 7800SM-17, 7800SM-18, 7800SM-19, 7800SM-21, 7800SM-22, 7800SM-24, 7800SM-27, 7800SM-30, 7800SM-32	

7807H	
7809M-5, 7809M-6, 7809M-7, 7809M-8, 7809M-10, 7809M-12, 7809M-14, 7809M-17, 7809M-19	

7809TORX-T20, 7809TORX-T25, 7809TORX-T27, 7809TORX-T30, 7809TORX-T40, 7809TORX-T45, 7809TORX-T55, 7809TORX-T50, 7809TORX-T60	
--	--

8150SL	
8164-1/2	
8154-11	
8160-5, 8160-10	
8171	
8166	
8172	

Fit&Go 3/3 Foam Inlay Adjustable/Combination/Double Open End Wrench Set - 34 Pcs



FF1A09

50 x 445 x 543 mm 1 FF1A09

111M-30, 111M-32, 111M-6, 111M-7, 111M-8, 111M-9, 111M-10, 111M-11, 111M-12, 111M-13, 111M-14, 111M-15, 111M-16, 111M-17, 111M-18, 111M-19, 111M-21, 111M-22, 111M-24, 111M-27	
1320RM-10-11, 1320RM-12-13, 1320RM-8-9	
6M-6-7, 6M-8-9, 6M-10-11, 6M-12-13, 6M-14-15, 6M-16-17, 6M-18-19, 6M-20-22, 6M-24-27, 6M-30-32	
9071C	

Fit&Go 3/3 Foam Inlay T-Handle + L-Key Screwdriver Set - 19 Pcs



FF1A1004

38 x 445 x 543 mm 1 FF1A1004

900T-050-150, 900T-020-100, 900T-025-100, 900T-030-100, 900T-040-150, 900T-060-200, 900T-080-200, 900T-100-200	
BE-9777B	

Fit&Go 3/3 T-Handle Screwdriver Set - 54 Pcs



FF1A1010	
51 x 445 x 543 mm	1 FF1A1010

901T-010-100, 901T-015-150, 901T-020-150, 901T-025-150, 901T-027-150, 901T-030-200, 901T-040-200	
808050	
1419-MD	
7805DM-10, 7805DM-12, 7805DM-13, 7805DM-17, 7805DM-19	
BE-9678	
59S/31-1	

Fit&Go 3/3 Hex/TORX T-Handle Screwdriver Set - 12 Pcs

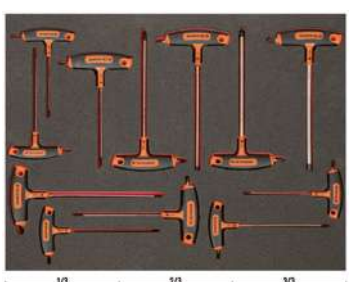

FF1A1011	
35 x 445 x 543 mm	1 FF1A1011

903T-2	
903T-1	

Fit&Go 3/3 Foam Inlay Combination Wrenches and Pliers Set - 82 Pcs



FF1A102	
40 x 445 x 543 mm	1 FF1A102

111M-32, 111M-8, 111M-9, 111M-10, 111M-11, 111M-12, 111M-13, 111M-14, 111M-15, 111M-16, 111M-17, 111M-18, 111M-19, 111M-21, 111M-22, 111M-24, 111M-27	
7224	
2800-180	
2900-180	
2890-180	
2990-180	
2101G-180	
2628 G-180IP	

Fit&Go 3/3 Foam Inlay Wrench and Bits Set - 19 Pcs



FF1A104	
35 x 445 x 543 mm	1 FF1A104

111M-32, 111M-7, 111M-8, 111M-9, 111M-10, 111M-11, 111M-12, 111M-13, 111M-14, 111M-15, 111M-16, 111M-17, 111M-18, 111M-19, 111M-21, 111M-22, 111M-24, 111M-27	
59/S54BC	

Fit&Go 3/3 Foam Inlay Socket Set - 93 Pcs



FF1A106	
55 x 543 x 445 mm	1 FF1A106

S87+7	
-------	--

Fit&Go 3/3 Foam Inlay Pliers Set - 16 Pcs



FF1A11	
43 x 543 x 445 mm	1 FF1A11

2101GC-125IP, 2101GC-160IP	
21HDGC-200IP	
2427 GC-200IP	
2430 GC-200 IP	
2628 GC-160IP	
2928-160, 2928-200, 2928-250	
2951-250	
2952-165	
8224CIP	
BFLA01	



Fit&Go 3/3 Foam Inlay Striking and Cutting Toolset - 11 Pcs



FF1A110



50 x 445 x 543 mm



1 FF1A110

2535L	
426TOR9	
9572-200	
MTB-8-25	
SQZ150003	
3875-LY3	
479-24	
481-400	
529-20-L	
225-PLUS	
208	

Fit&Go 3/3 Foam Inlay Wrench/Adjustable Wrench Set - 22 Pcs



FF1A112



35 x 445 x 543 mm



1 FF1A112

S4RM/3T	
111M-6, 111M-7, 111M-8, 111M-9, 111M-10, 111M-11, 111M-12, 111M-13, 111M-14, 111M-15, 111M-16, 111M-17, 111M-18, 111M-19, 111M-20, 111M-21, 111M-22, 111M-24, 111M-27	
9031	
9070	

Fit&Go 3/3 Foam Inlay Pliers and Striking Toolset - 18 Pcs



FF1A114



42 x 445 x 543 mm



1 FF1A114

8224 IP	
2632	
3734-2, 3734-3, 3734-4, 3734-5, 3734-6, 3734-8	
2800-180	
2890-180	
2900-180	
2990-180	
4611-2	
479-24	
1435/5	
1178-SCRIBE	
2430 G-160 IP	
2101G-180IP	

Fit&Go 3/3 Foam Inlay Measuring and Cutting Toolset - 9 Pcs



FF1A115



35 x 445 x 543 mm



1 FF1A115

1-210-08-1-2	
9045-B-250	
406T-225	
MTB-5-25	
BFLA01	
K-AP-1	
268	
5515T-52	
319	

Fit&Go 3/3 Foam Inlay Wrench and Screwdriver Set - 26 Pcs



FF1A117



35 x 445 x 543 mm



1 FF1A117

B191.040.100	
B190.055.125, B190.065.150	
B192.000.075, B192.001.100, B192.002.125	
111M-32, 111M-6, 111M-7, 111M-8, 111M-9, 111M-10, 111M-11, 111M-12, 111M-13, 111M-14, 111M-15, 111M-16, 111M-17, 111M-18, 111M-19, 111M-21, 111M-22, 111M-24, 111M-27	
8073 IP	

Fit&Go 3/3 Foam Inlay Pliers and File Set - 14 Pcs



FF1A118



35 x 445 x 543 mm



1 FF1A118

1-100-08-2-2	
2430 G-160 IP	
2628G-200IP	
2800-180	
2900-180	
2890-180	
2990-180	
5515T	
1-170-08-2-2	
1-210-08-2-2	
1-230-08-2-2	
2535F1	
8224 IP	
2101G-180IP	

Fit&Go 3/3 Foam Inlay Striking and Cutting Toolset - 10 Pcs



FF1A119



47 x 445 x 543 mm

1 FF1A119

3734S/6	
481-300	
KGAU-01	
MTB-5-25-M-E	
137-10	
1150-1/2H/P	
426TOR9	
BLTS10	
375-8	
319	

Fit&Go 3/3 Foam Inlay Striking and File Set - 19 Pcs



FF1A12



35 x 445 x 543 mm

1 FF1A12

FS-8	
1-100-06-1-2, 1-100-06-2-2	
1-160-06-1-2	
1-210-06-1-2	
1-230-06-1-2	
2509	
2535F2	
3625W-35	
3734-3, 3734-5, 3734-8	
3735-4-120	
3740-150	
3745-150	
481-300, 481-500	
319	
8157-15	

Fit&Go 3/3 Foam Inlay Wrench/Pliers Set - 28 Pcs



FF1A121



40 x 445 x 543 mm

1 FF1A121

111M-8, 111M-9, 111M-10, 111M-11, 111M-12, 111M-13, 111M-14, 111M-15, 111M-16, 111M-17, 111M-18, 111M-19, 111M-22	
2470 G-200	
7224	
2953-250	
6M-6-7, 6M-8-9, 6M-10-11, 6M-12-13, 6M-14-15, 6M-16-17, 6M-18-19, 6M-20-22	
2800-180	
2900-180	
2101G-160IP	

Fit&Go 3/3 Foam Inlay Wrench/Screwdriver Set - 25 Pcs



FF1A124



45 x 445 x 543 mm

1 FF1A124

B191.040.100	
B190.055.125, B190.065.150	
B192.000.075, B192.001.100, B192.002.125	
111M-32, 111M-6, 111M-7, 111M-8, 111M-9, 111M-10, 111M-11, 111M-12, 111M-13, 111M-14, 111M-15, 111M-16, 111M-17, 111M-18, 111M-19, 111M-21, 111M-22, 111M-24, 111M-27	

Fit&Go 3/3 Foam Inlay Striking/Cutting Toolset - 11 Pcs



FF1A127



35 x 445 x 543 mm

1 FF1A127

3734S/6	
479-16	
3625W-35	
MTG-3-16	
KB18-01	
KSBG18-10DISPEN	
8224 IP	
2101G-160IP	
2628 G-180IP	
2430 G-200 IP	
2530	

Fit&Go 3/3 Foam Inlay Wrench/File Set - 18 Pcs



FF1A128



65 x 445 x 543 mm

1 FF1A128

9029, 9031	
111Z-1/4, 111Z-5/16, 111Z-3/8, 111Z-7/16, 111Z-1/2, 111Z-9/16, 111Z-5/8, 111Z-11/16, 111Z-3/4, 111Z-13/16, 111Z-7/8, 111Z-1	
1-473-08-2-2	
361-12	
2633/S4	
S4RM/5T	



Fit&Go 3/3 Foam Inlay Pliers/Screwdriver Set - 16 Pcs



FF1A129

45 x 445 x 543 mm 1 FF1A129

2171G-180	
2470 G-200	
2477 G-200	
9033, 9035	
1520 G	
808050P	
B191.040.100	
B190.055.125, B190.065.150	
B192.000.075, B192.001.100, B192.002.125	
BE-9777B	
2678 G-200	
59S/31-1	

Fit&Go 3/3 Foam Inlay 1/4" + 3/8" Socket and Pear Head Ratchet Set - 83 Pcs



FF1A131

55 x 445 x 543 mm 1 FF1A131

A6700DZ-1/2, A6700DZ-1/4, A6700DZ-11/32, A6700DZ-3/16, A6700DZ-3/8, A6700DZ-5/16, A6700DZ-7/16, A6700DZ-7/32, A6700DZ-9/16, A6700DZ-9/32	
A6710DZ-1/2, A6710DZ-1/4, A6710DZ-11/32, A6710DZ-3/16, A6710DZ-3/8, A6710DZ-5/16, A6710DZ-7/16, A6710DZ-7/32, A6710DZ-9/16, A6710DZ-9/32	
A6800DM-4, A6800DM-10	
A6800DZ-1/2, A6800DZ-1/4, A6800DZ-11/32, A6800DZ-3/16, A6800DZ-3/8, A6800DZ-5/16, A6800DZ-7/16, A6800DZ-7/32, A6800DZ-9/16, A6800DZ-9/32	
A7400DZ-1/2, A7400DZ-1/4, A7400DZ-11/16, A7400DZ-13/16, A7400DZ-17/32, A7400DZ-19/32, A7400DZ-3/4, A7400DZ-3/8, A7400DZ-5/16, A7400DZ-5/8, A7400DZ-7/16, A7400DZ-7/8, A7400DZ-9/16	

A7402DZ-1/2, A7402DZ-1/4, A7402DZ-11/16, A7402DZ-13/16, A7402DZ-19/32, A7402DZ-3/4, A7402DZ-3/8, A7402DZ-5/16, A7402DZ-5/8, A7402DZ-7/16, A7402DZ-7/8, A7402DZ-9/16	
6700SZ-5/32	
6950SL	
6954	
6956	
6958	
6960, 6961, 6962, 6962L	
6966	
6972H	
7407H, 7408H	
7750SL	
7752	
7754	
7758	
7760, 7761, 7762	
7764	
7765	
7766	
8164-1/2	
U-S6106KA	
8171	

Fit&Go 3/3 Foam Inlay Socket/Bit Set - 53 Pcs



FF1A130

45 x 445 x 543 mm 1 FF1A130

7800SM-8, 7800SM-9, 7800SM-10, 7800SM-11, 7800SM-12, 7800SM-13, 7800SM-14, 7800SM-15, 7800SM-16, 7800SM-17, 7800SM-18, 7800SM-19, 7800SM-21, 7800SM-22, 7800SM-23, 7800SM-24, 7800SM-27, 7800SM-30, 7800SM-32	
8150SL	
SBS87S, SBS87	
SBS83-3, SBS83-5, SBS83-10	
SBS85	
SBS86	
SBS88	
SBS89	
7809TORX-T20, 7809TORX-T25, 7809TORX-T27, 7809TORX-T30, 7809TORX-T40, 7809TORX-T45, 7809TORX-T50, 7809TORX-T55, 7809TORX-T60	

7809M-5, 7809M-6, 7809M-7, 7809M-8, 7809M-9, 7809M-10, 7809M-12, 7809M-14, 7809M-17, 7809M-19	
7809M-5-180, 7809M-6-140, 7809M-7-100, 7809M-8-120, 7809M-10-140	

Fit&Go 3/3 Foam Inlay Mixed Tightening/Measuring Toolset - 10 Pcs



FF1A131

40 x 445 x 543 mm 1 FF1A131

SQZ150003	
FS-8	
SQZ150003-SBL	
481-400	
3734-2, 3734-4, 3734-5, 3734-6, 3734-8, 3734-3	
3735-5-120	
3740-175	
BE-9678	
1547	
319	
208	
3625N-32	











Fit&Go 3/3 Foam Inlay Mixed Sockets/File Set - 31 Pcs

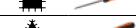

FF1A132

40 x 445 x 543 mm 1 FF1A132



7400SM-6, 7400SM-7, 7400SM-8, 7400SM-9, 7400SM-10, 7400SM-11, 7400SM-12, 7400SM-13, 7400SM-14, 7400SM-15, 7400SM-16, 7400SM-17, 7400SM-18, 7400SM-19	
7750SL	
SBS705	

SBS755	
SBS723, SBS724	
SBS775	
SBS760, SBS761, SBS762	
1-100-08-1-2	
1-160-08-1-2	
1-170-08-2-2	
1-210-08-1-2	
1-230-08-1-2	
2635	
1150D	
2681	



Fit&Go 3/3 Foam Inlay Screwdriver Set - 17 Pcs



FF1A133



35 x 445 x 543 mm 1 FF1A133

900T-020-100, 900T-025-100, 900T-030-100, 900T-040-150, 900T-050-150, 900T-060-200, 900T-080-200, 900T-100-200	
B194.006.075, B194.007.075, B194.008.075, B194.009.075, B194.010.075, B194.015.100, B194.020.100, B194.025.125, B194.030.150	

Fit&Go 3/3 Foam Inlay Combination Wrench Set - 21 Pcs



FF1A134

37 x 445 x 543 mm 1 FF1A134

111M-30, 111M-32, 111M-6, 111M-7, 111M-8, 111M-9, 111M-10, 111M-11, 111M-12, 111M-13, 111M-14, 111M-15, 111M-16, 111M-17, 111M-18, 111M-19, 111M-20, 111M-21, 111M-22, 111M-24, 111M-27	
---	---



Fit&Go 3/3 Foam Inlay Wrench/Bit Set - 51 Pcs



FF1A135

40 x 445 x 543 mm 1 FF1A135

4040M-8-9, 4040M-10-11, 4040M-12-13, 4040M-14-15, 4040M-16-17, 4040M-18-19, 4040M-20-22, 4040M-21-23	
59S/31-1	
6M-6-7, 6M-8-9, 6M-10-11, 6M-12-13, 6M-14-15, 6M-16-17, 6M-18-19, 6M-20-22, 6M-21-23, 6M-24-27, 6M-25-28, 6M-30-32	











Fit&Go 3/3 Foam Inlay 1/4" Socket/Pliers/Screwdriver Set - 40 Pcs

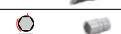







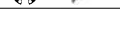

FF1A136

40 x 445 x 543 mm 1 FF1A136

2628 G-180	
2430 G-160	
8224	
2101G-160	
6700SM-4.5, 6700SM-5, 6700SM-5.5, 6700SM-6, 6700SM-7, 6700SM-8, 6700SM-9, 6700SM-10, 6700SM-11, 6700SM-12, 6700SM-13, 6700SM-14, 6700SM-4	
6950SL	
SBS67	
SBS69	
SBS65	
SBS63-2, SBS63-4, SBS63-6	
2800-180	
2890-180	

2900-180	
2990-180	
B191.030.075, B191.040.100	
B190.055.100, B190.065.125, B190.080.150	
B195.050.025	
B195.001.025	
B192.001.100, B192.002.125	
808050	
6954	















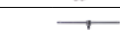

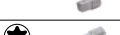
Fit&Go 3/3 Foam Inlay Socket and Round Head Ratchet Set - 59 Pcs



FF1A137

50 x 445 x 543 mm 1 FF1A137

7800SM-8, 7800SM-9, 7800SM-10, 7800SM-11, 7800SM-12, 7800SM-13, 7800SM-14, 7800SM-15, 7800SM-16, 7800SM-17, 7800SM-18, 7800SM-19, 7800SM-21, 7800SM-22, 7800SM-23, 7800SM-24, 7800SM-27, 7800SM-30, 7800SM-32	
8150SL	
SBS87S, SBS87	
SBS83-3, SBS83-5, SBS83-10	
SBS85	
SBS86	
SBS88	
SBS89	
7809TORX-T50, 7809TORX-T20, 7809TORX-T25, 7809TORX-T27, 7809TORX-T30, 7809TORX-T40, 7809TORX-T45, 7809TORX-T55, 7809TORX-T60	
6700SM-4, 6700SM-4.5, 6700SM-5, 6700SM-5.5, 6700SM-6, 6700SM-7, 6700SM-8, 6700SM-9, 6700SM-10, 6700SM-11, 6700SM-12, 6700SM-13, 6700SM-14	
6950SL	
SBS67	
SBS69	
SBS65	
SBS63-2, SBS63-4, SBS63-6	
6954	



Fit&Go 3/3 Foam Inlay Mixed Striking/
Cutting Toolset - 16 Pcs



FF1A138

40 x 445 x 543 mm 1 FF1A138

SQZ150003	
FS-8	
SQZ150003-SBL	
481-400	
3734-2, 3734-3, 3734-4, 3734-5, 3734-6, 3734-8	
3735-5-120	
3740-175	
BE-9678	
319	
208	
3625N-32	

Fit&Go 3/3 Foam Inlay Screwdriver Set -
18 Pcs



FF1A139

38 x 445 x 543 mm 1 FF1A139

808050	
900T-020-100, 900T-025-100, 900T-030-100, 900T-040-150, 900T-050-150, 900T-060-200, 900T-080-200, 900T-100-200	
B191.030.075, B191.040.100	
B190.055.100, B190.065.125, B190.080.150	
B195.050.025	
B195.001.025	
B192.001.100, B192.002.125	

Fit&Go 3/3 Foam Inlay Imperial
Combination and Double Open End
Wrench Set - 43 Pcs



FF1A14

46 x 445 x 543 mm 1 FF1A14

111Z-1, 111Z-1/2, 111Z-1/4, 111Z-11/16, 111Z-13/16, 111Z-15/16, 111Z-3/4, 111Z-3/8, 111Z-5/16, 111Z-5/8, 111Z-7/16, 111Z-7/8, 111Z-9/16	
1320RZ-1/2-9/16, 1320RZ-1/4-5/16, 1320RZ-3/8-7/16, 1320RZ-5/16-11/32	
1931Z-1/2, 1931Z-1/4, 1931Z-11/32, 1931Z-3/16, 1931Z-3/8, 1931Z-5/16, 1931Z-5/32, 1931Z-7/16, 1931Z-7/32, 1931Z-9/16, 1931Z-9/32	
1950MZ-3/8	
1952Z-11/32	
6Z-1.1/16-1.1/4, 6Z-1.1-1/8, 6Z-1/2-9/16, 6Z-1/4-5/16, 6Z-15/16-1, 6Z-19/32-11/16, 6Z-25/32-13/16, 6Z-3/8-7/16, 6Z-5/16-11/32, 6Z-5/8-3/4, 6Z-7/8-15/16	
8069 C IP	
9070C	

Fit&Go 3/3 Foam Inlay Mixed Wrench/
Pliers Set - 46 Pcs

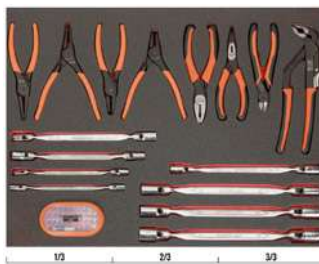

FF1A141

42 x 445 x 543 mm 1 FF1A141

2628 G-180	
2430 G-160	
8224	
2101G-160	
2800-180	
2890-180	
2900-180	
2990-180	

4040M-8-9, 4040M-10-11, 4040M-12-13, 4040M-14-15, 4040M-16-17, 4040M-18-19, 4040M-20-22, 4040M-21-23

59S/31-1

Fit&Go 3/3 Foam Inlay Measuring Tapes/
Socket/Bit Set - 71 Pcs



FF1A142

50 x 445 x 543 mm 1 FF1A142

7800SM-8, 7800SM-9, 7800SM-10, 7800SM-11, 7800SM-12, 7800SM-13, 7800SM-14, 7800SM-15, 7800SM-16, 7800SM-17, 7800SM-18, 7800SM-19, 7800SM-21, 7800SM-22, 7800SM-23, 7800SM-24, 7800SM-27, 7800SM-30, 7800SM-32

8150SL

BE-9678

SBS87S, SBS87

1547

1150D

59S/31-1

8160-3, 8160-5, 8160-10

8166

8154-11

8171

8172

Fit&Go 3/3 Foam Inlay Mixed Striking/
Cutting Toolset - 15 Pcs











FF1A143

45 x 445 x 543 mm 1 FF1A143

SQZ150003

FS-8

SQZ150003-SBL























MTB-5-25	
481-400	
3734-2, 3734-3, 3734-4, 3734-5, 3734-6, 3734-8	
3735-5-120	
3740-175	
319	
208	
3625N-32	

Fit&Go 3/3 Foam Inlay Screwdriver/File/ Pliers Set - 20 Pcs



FF1A145

 38 x 445 x 543 mm  1 FF1A145

















2628 G-180	
2430 G-160	
8224	 
2101G-160	
8045LVDE	 
808050	 
613-3-75	
611-4-100, 611-5.5-100, 611-6.5-150, 611-8-150, 611-6.5-25	
615-1-100, 615-2-125, 615-2-25	
1-100-08-1-2	 
1-160-08-1-2	 
1-170-08-2-2	 
1-210-08-1-2	 
1-230-08-1-2	 

Fit&Go 3/3 Foam Inlay 1/2" Socket/Pliers Set - 34 Pcs



FF1A146

 50 x 445 x 543 mm  1 FF1A146

















2628 G-180	
2430 G-160	
8224	 
2101G-160	
FS-8	 
7800SM-8, 7800SM-9, 7800SM-10, 7800SM-11, 7800SM-12, 7800SM-13, 7800SM-14, 7800SM-15, 7800SM-16, 7800SM-17, 7800SM-18, 7800SM-19, 7800SM-21, 7800SM-22, 7800SM-23, 7800SM-24, 7800SM-27, 7800SM-30, 7800SM-32	 
8150SL	
SBS87S, SBS87	
8160-3, 8160-5, 8160-10	
8166	
8154-11	
8171	
8172	

Fit&Go 3/3 Foam Inlay Cutting/Striking/ Screwdriver Set - 16 Pcs



FF1A147

 40 x 445 x 543 mm  1 FF1A147













2951-250, 2951-180	
SQZ150003	
SQZ150003-SBL	
B191.030.075, B191.040.100	 
B190.055.100, B190.065.125, B190.080.150	 
B195.050.025	 
B195.001.025	 
B192.001.100, B192.002.125	 
319	
208	
3625N-32	

Fit&Go 3/3 Foam Inlay Cutters and Pliers Set - 12 Pcs



FF1A15

 40 x 445 x 543 mm  1 FF1A15

2101GC-125IP, 2101GC-160IP	
2233D-240IP	
2421GC-180IP	
2427 GC-200IP	
2430 GC-200 IP	
2628 GC-160IP	
2650	 
2855, 2855 D	 
2951-180	
8224CIP	 

Fit&Go 3/3 Foam Inlay 1/4" & 1/2" Socket Set and Wrenches - 94 Pcs



FF1A153

 335 x 445 x 543 mm  1 FF1A153

S87+7	
-------	---



Fit&Go 3/3 Foam Inlay Mixed Striking/
Cutting/ Pliers Set - 13 Pcs



FF1A154



37 x 445 x 543 mm

1 FF1A154

2171G-160	
224 D	
2470 G-160	
317	
3625W-28	
3733-4	
3734-3, 3734-6	
3735-5-120	
481-400	
KB18-01	
KSBG18-10DISPEN	
2678 G-180	

Fit&Go 3/3 Foam Inlay Mixed Toolset - 18
Pcs



FF1A16



40 x 445 x 543 mm

1 FF1A16

KE18-01	
1150-1/2H/P	
MTB-3-16	
1177-SCRIBE	
1544	
2509	
2535F2	
2632	
268	
2744	

2820EF2	
3525HB	
5471 F-145	
5515T	
5515T-52	
5516	
BFLA01	
SR300-E	

Fit&Go 3/3 Foam Inlay 1/4" & 1/2" Socket
Set, Spanners & Pliers - 50 pcs



FF1A164



40 x 445 x 543 mm

1 FF1A164

1RM-10, 1RM-11, 1RM-12, 1RM-13, 1RM-14, 1RM-15, 1RM-16, 1RM-17, 1RM-18, 1RM-19, 1RM-8	
2058-BR	
S330	
111M-24, 111M-21, 111M-27, 111M-32	

Fit&Go 3/3 Foam Inlay 1/2" & 3/8" Socket
Set & Bit Set - 177 pcs



FF1A165



40 x 445 x 543 mm

1 FF1A165

59/S100B-T	
BE5049	
S1214L	
S1612L	
SBS87	
7402GPR-16	

Fit&Go 3/3 Foam Inlay Pliers, L-Keys,
Magnetic Dish and Picking - 23 pcs



FF1A167



45 x 445 x 543 mm

1 FF1A167

1178-SCRIBE	
1419-MD	
2101G-160IP	
2430 G-190HD	
2628 G-180IP	
2744	
2953-250	
8224	
9031	
BE-9770	
BWSS12P317, BWSS12P319, BWSS12P321	
CR B 02	
2530	

Fit&Go 3/3 Foam Inlay Cutting Tools, Files
& Impact Driver Set - 36 pcs





FF1A168



40 x 445 x 543 mm

1 FF1A168











1-100-08-2-2	
1-210-08-2-2	
1-230-08-2-2	
2485	
2487	
319	
268	
3740-100, 3740-150	
5515T	
782-U	

7865	
KB18-01	
KSBG18-10DISPEN	

Fit&Go 3/3 Foam Inlay Cutting Tools, Files & Impact Driver Set - 13 pcs





FF1A169			
35 x 445 x 543 mm	1	FF1A169	

2681	
3625W-28	
3733-4	
3734-3, 3734-4, 3734-6	
3735-5-120	
481-400	
BB10	
BE66152	
BT10P330	
MA321	
MTB-3-16	

Fit&Go 3/3 Foam Inlay Metric Double Head Offset Socket Spanners Set - 14 pcs











FF1A170			
40 x 445 x 543 mm	1	FF1A170	

28M-16, 28M-15, 28M-18, 28M-17, 28M-12, 28M-11, 28M-14, 28M-13, 28M-24, 28M-19, 28M-22, 28M-8, 28M-10, 28M-9	
--	---

Fit&Go 3/3 Foam Inlay Striking/File Set - 24 Pcs













FF1A18			
44 x 445 x 543 mm	1	FF1A18	

1-476-04-3-2	
2633/S4	
3734S/6	
3736S/6	
481-200, 481-500	
782-U	
3625N-32	

Fit&Go 3/3 Foam Inlay Striking, Cutting & Pliers - 14 Pcs















FF1A185			
40 x 445 x 543 mm	1	FF1A185	

3734S/6-T	
479-16	
3625W-35	
KB18-01	
KSBG18-10DISPEN	
2101G-180IP	
2470 G-200	
2678 G-180	
8224 IP	
2530	

Fit&Go 3/3 Foam Inlay Striking, Pliers, Cutting & Pick-Up Tool - 25 pcs







FF1A189			
40 x 445 x 543 mm	1	FF1A189	

3734S/6	
479-16	
3625W-35	
MTG-3-16	
KB18-01	
KSBG18-10DISPEN	
2101G-180IPD	
2630GC-180IP	
2470 G-200	
8224 IP	
2530	

Fit&Go 3/3 Foam Inlay Adjustable/Combination/Double Open End Wrench Set - 33 Pcs



FF1A19			
50 x 543 x 445 mm	1	FF1A19	

111M-30, 111M-32, 111M-6, 111M-7, 111M-8, 111M-9, 111M-10, 111M-11, 111M-12, 111M-13, 111M-14, 111M-15, 111M-16, 111M-17, 111M-18, 111M-19, 111M-20, 111M-21, 111M-22, 111M-24, 111M-27	
6M-6-7, 6M-8-9, 6M-10-11, 6M-12-13, 6M-14-15, 6M-16-17, 6M-18-19, 6M-20-22, 6M-21-23, 6M-24-27, 6M-30-32	
92C	



Fit&Go 3/3 Foam Inlay 1/2" & 1/4" Socket Set & Torque Wrench - 51 pcs



FF1A194

40 x 445 x 543 mm 1 FF1A194

6968		
6700SM-14, 6700SM-13, 6700SM-12, 6700SM-11, 6700SM-10, 6700SM-9, 6700SM-8, 6700SM-7, 6700SM-6, 6700SM-5, 6700SM-4		
6709M-3, 6709M-8, 6709M-6, 6709M-5, 6709M-4		
6950SL		
7800SM-24, 7800SM-23, 7800SM-22, 7800SM-13, 7800SM-12, 7800SM-11, 7800SM-10, 7800SM-9, 7800SM-8, 7800SM-21, 7800SM-19, 7800SM-18, 7800SM-17, 7800SM-16, 7800SM-15, 7800SM-14		
7809M-8, 7809M-7, 7809M-10, 7809M-6, 7809M-5		
7809TORX-T20, 7809TORX-T25, 7809TORX-T30, 7809TORX-T40		
7455-200		
8150SL		
8168		
K6650-1/4-1P		
6960W-2, 6960W-6		
8160-10, 8160-5		

Fit&Go 3/3 Foam Inlay Double Ring End/ Double Socket Head Ratchet Set - 18 Pcs



FF1A20

50 x 445 x 543 mm 1 FF1A20

2M-6-7, 2M-8-9, 2M-10-11, 2M-12-13, 2M-14-15, 2M-16-17, 2M-18-19, 2M-20-22, 2M-21-23, 2M-24-27, 2M-30-32		
4040M-10-11, 4040M-12-13, 4040M-14-15, 4040M-16-17, 4040M-18-19, 4040M-21-23		
2953-250		

Fit&Go 3/3 Foam Inlay Puller/Round Head Ratchet/Socket Set - 58 Pcs



FF1A22

50 x 445 x 543 mm 1 FF1A22

7800SM-10, 7800SM-12, 7800SM-13, 7800SM-14, 7800SM-16, 7800SM-17, 7800SM-18, 7800SM-19, 7800SM-21, 7800SM-22, 7800SM-23, 7800SM-24, 7800SM-27, 7800SM-30, 7800SM-32		
7805SM-13, 7805SM-16, 7805SM-17, 7805SM-18, 7805SM-19, 7805SM-21, 7805SM-22, 7805SM-24, 7805SM-27, 7805SM-30, 7805SM-32		
7809M-5, 7809M-6, 7809M-8, 7809M-10, 7809M-12, 7809M-14		
8150SL		
6700SM-4, 6700SM-4.5, 6700SM-5, 6700SM-5.5, 6700SM-6, 6700SM-7, 6700SM-8, 6700SM-9, 6700SM-10, 6700SM-11, 6700SM-12, 6700SM-13		
6958		
6954		
6960, 6962		
6966		
6950SL		
4532-A		
8157-15		
8154-11		
8160-3, 8160-5		
8166		

Fit&Go 3/3 Foam Inlay Measuring Tape/ Striking/Pliers Set - 21 Pcs



FF1A23

40 x 445 x 543 mm 1 FF1A23

3735-4-120	
3734-2, 3734-3, 3734-4, 3734-5, 3734-6, 3734-8	
2630GC-180IP	
2430 GC-200 IP	
2427 GC-200IP	
2900-180	
2890-180	
2990-180	
2800-180	
7224	
2101GC-160IP	
479-16	
1547	
MTB-3-16	
SC127	
3625N-32	

Fit&Go 3/3 Foam Inlay Circlip Pliers & Spanners Set - 17 pcs

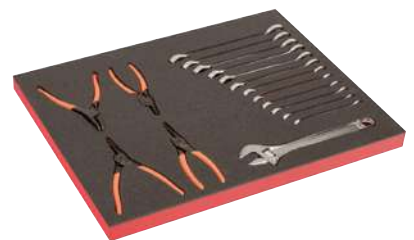

FF1A230

40 x 445 x 543 mm 1 FF1A230

1RM-9, 1RM-8, 1RM-11, 1RM-10, 1RM-13, 1RM-12, 1RM-15, 1RM-14, 1RM-17, 1RM-16, 1RM-19, 1RM-18		
28-29/S4		
8072 C		

Fit&Go 3/3 Foam Inlay 3/4" Socket Set - 26 Pcs



FF1A2301



70 x 445 x 543 mm	1	FF1A2301	

8900DM-19, 8900DM-22, 8900DM-23, 8900DM-24, 8900DM-25, 8900DM-26, 8900DM-27, 8900DM-28, 8900DM-29, 8900DM-30, 8900DM-32, 8900DM-33, 8900DM-34, 8900DM-36, 8900DM-41, 8900DM-46, 8900DM-50, 8900DM-55, 8900DM-60		
8954		
8954A		
8958A		
8961		
8965		
8966		
8955N/B		

Fit&Go 3/3 Laser Marked Foam Inlay with Automotive Plug Socketry - 31 pcs



FF1A235

50 x 445 x 543 mm	4.10 kg	1	FF1A235

BE61110		
BE621702, BE621703, BE621701, BE621706, BE621707, BE621704, BE621705, BE621710, BE621711, BE621708, BE621709, BE621714, BE621715, BE621712, BE621713, BE621716, BE621717		
BE6810		
2M-6-7, 2M-8-9, 2M-12-13, 2M-18-19, 2M-16-17, 2M-10-11, 2M-14-15, 2M-24-26, 2M-21-23, 2M-27-29, 2M-20-22, 2M-30-32		

Fit&Go 3/3 Laser Marked Foam Inlay for Automotive Body Shop - 13 pcs



FF1A236

55 x 445 x 543 mm	9.5 kg	1	FF1A236

3-330-14-2-0		
9-462-14-0-0		
1467-250		
BBSH2F		
BBSH2CA		
BBSDW		
BBSDA		
BBSDT		
BBSDH		
BBSDC		
BBSDHR		
BBSS1		
2485		

Fit&Go 3/3 Foam Inlay Measuring Tape/Striking/Pliers Set - 19 Pcs



FF1A24

45 x 445 x 543 mm	1	FF1A24	

3735-4-120		
3734-2, 3734-3, 3734-4, 3734-5, 3734-6, 3734-8		
2630GC-180IP		

2430 GC-200 IP		
2900-180		
2890-180		
2990-180		
2800-180		
7224		
2101GC-160IP		
479-16		
3625N-32		
MTB-3-16		
SC127		

Fit&Go 3/3 Foam Inlay Socket and Round Head Ratchet Set - 50 Pcs



FF1A25

50 x 445 x 543 mm	1	FF1A25	

7800SM-10, 7800SM-12, 7800SM-13, 7800SM-14, 7800SM-15, 7800SM-16, 7800SM-17, 7800SM-18, 7800SM-19, 7800SM-21, 7800SM-22, 7800SM-23, 7800SM-24, 7800SM-27, 7800SM-30, 7800SM-32		
7805SM-13, 7805SM-16, 7805SM-17, 7805SM-18, 7805SM-19, 7805SM-21, 7805SM-22, 7805SM-24, 7805SM-27, 7805SM-30, 7805SM-32		
8150SL		
6700SM-4, 6700SM-4.5, 6700SM-5, 6700SM-5.5, 6700SM-6, 6700SM-7, 6700SM-8, 6700SM-9, 6700SM-10, 6700SM-11, 6700SM-12, 6700SM-13		
6954		
6960, 6962		
6966		
6950SL		
2953-250		
8166		
8154-11		
8160-3, 8160-5		



Fit&Go 3/3 Foam Inlay 1/4" + 1/2" + 3/8" Socket and Pear/Round Head Ratchet Set - 83 Pcs



FF1A2501



50 x 445 x 543 mm	1 FF1A2501

6700SM-4, 6700SM-5, 6700SM-5.5, 6700SM-6, 6700SM-7, 6700SM-8, 6700SM-9, 6700SM-10, 6700SM-11, 6700SM-12, 6700SM-13		
6700TORX-E8, 6700TORX-E10		
6709M-3, 6709M-4, 6709M-5, 6709M-6, 6709M-8		
6709TORX-T8, 6709TORX-T10, 6709TORX-T15, 6709TORX-T20, 6709TORX-T25, 6709TORX-T27, 6709TORX-T30, 6709TORX-T40		
6950SL		
6954		
6956		
6962		
6966		
7400SM-8, 7400SM-9, 7400SM-10, 7400SM-11, 7400SM-12, 7400SM-13, 7400SM-14, 7400SM-15, 7400SM-16, 7400SM-17, 7400SM-18, 7400SM-19, 7400SM-20, 7400SM-21, 7400SM-22		
7400TORX-E8, 7400TORX-E10, 7400TORX-E12, 7400TORX-E14		
7750SL		
7754		
7762		
7764		
7765		
7766		
7768		
7800SM-13, 7800SM-17, 7800SM-12, 7800SM-18, 7800SM-19, 7800SM-20, 7800SM-27, 7800SM-30, 7800SM-32, 7800SM-21, 7800SM-22, 7800SM-24		
7809M-12, 7809M-10		
7809TORX-T20, 7809TORX-T25, 7809TORX-T40, 7809TORX-T50, 7809TORX-T55		
8150SL		
8164-1/2		
8154-11		
8160-10		
8171		
8166		
8172		

Fit&Go 3/3 Foam Inlay 1/2"-3/8" Socket Set - 101 Pcs



FF1A2503



55 x 445 x 543 mm	1 FF1A2503

6700SM-4.5, 6700SM-4, 6700SM-5, 6700SM-5.5, 6700SM-6, 6700SM-7, 6700SM-8, 6700SM-9, 6700SM-10, 6700SM-11, 6700SM-12, 6700SM-13, 6700SM-14		
7800SM-10, 7800SM-11, 7800SM-12, 7800SM-13, 7800SM-14, 7800SM-15, 7800SM-18, 7800SM-19, 7800SM-21, 7800SM-22, 7800SM-23, 7800SM-24, 7800SM-30, 7800SM-26, 7800SM-27, 7800SM-28, 7800SM-32, 7800SM-16, 7800SM-17, 7800SM-8, 7800SM-9		
BE-9678		
7809M-10, 7809M-12, 7809M-14, 7809M-17, 7809M-19, 7809M-5, 7809M-7, 7809M-8, 7809M-9, 7809M-6		
59S/31-1		
7809M-10-140, 7809M-5-180, 7809M-6-140, 7809M-7-100, 7809M-8-120		
808050		
8155-1/2		
6950		
6954		
6956		
6960, 6962		
6966		
8154-11		
8160-5, 8160-10		
8166		

Fit&Go 3/3 Foam Inlay Pliers and Wrench Set - 27 Pcs



FF1A26



50 x 445 x 543 mm	1 FF1A26

111M-30, 111M-32, 111M-6, 111M-7, 111M-8, 111M-9, 111M-10, 111M-11, 111M-12, 111M-13, 111M-14, 111M-15, 111M-16, 111M-17, 111M-18, 111M-19, 111M-20, 111M-21, 111M-22, 111M-24, 111M-27		
2630GC-180IP		
2430 GC-200 IP		
7224		
2953-250		
2101GC-160IP		
SC127		

Fit&Go 3/3 Foam Inlay Socket and Striking Set - 48 Pcs



FF1A28



50 x 445 x 543 mm	1 FF1A28

7800SM-18, 7800SM-19, 7800SM-21, 7800SM-22, 7800SM-23, 7800SM-24, 7800SM-27, 7800SM-30, 7800SM-32, 7800SM-10, 7800SM-12, 7800SM-13, 7800SM-14, 7800SM-15, 7800SM-16, 7800SM-17		
8150SL		
6700SM-4.5, 6700SM-5, 6700SM-5.5, 6700SM-6, 6700SM-7, 6700SM-8, 6700SM-9, 6700SM-10, 6700SM-11, 6700SM-12, 6700SM-13, 6700SM-4		
6954		
6960, 6962		
6966		
6950SL		
3735-4-120		
3734-2, 3734-3, 3734-4, 3734-5, 3734-6, 3734-8		
479-16		
MTB-3-16		
3625N-32		
8154-11		
8160-3, 8160-5		
8166		

Fit&Go 3/3 Foam Laser Marked Inlay Spanners, Pliers & Sockets - 45 pcs



FF1A29NB

50 x 445 x 543 mm	6.26 kg	1	FF1A29NB

111M-6, 111M-7, 111M-8, 111M-9, 111M-13, 111M-12, 111M-11, 111M-10, 111M-24, 111M-22, 111M-17, 111M-16, 111M-15, 111M-14, 111M-21, 111M-19, 111M-18

8071 IP

2470 G-160

2971G-250

2171G-160

8150SL

SBS83-10, SBS83-5

SBS87S

SBS85

SP16SLH

7800SM-27, 7800SM-22, 7800SM-23, 7800SM-24, 7800SM-18, 7800SM-19, 7800SM-20, 7800SM-21, 7800SM-14, 7800SM-15, 7800SM-16, 7800SM-17, 7800SM-10, 7800SM-11, 7800SM-12, 7800SM-13, 7800SM-30, 7800SM-22

Fit&Go 3/3 Foam Inlay Combination Wrench Set - 21 Pcs



FF1A3001

40 x 445 x 543 mm	1	FF1A3001

111M-32, 111M-30, 111M-24, 111M-22, 111M-27, 111M-17, 111M-16, 111M-15, 111M-14, 111M-21, 111M-20, 111M-19, 111M-18, 111M-9, 111M-8, 111M-7, 111M-6, 111M-13, 111M-12, 111M-11, 111M-10

Fit&Go 3/3 Foam Inlay Combination Ratcheting Wrench Set - 7 Pcs



FF1A3002

35 x 445 x 543 mm	1	FF1A3002

1RM-24, 1RM-22, 1RM-21, 1RM-19, 1RM-32, 1RM-30, 1RM-27

Fit&Go 3/3 Foam Inlay Combination Offset Wrench Set - 28 Pcs



FF1A3003

40 x 445 x 543 mm	1	FF1A3003

1952M-27, 1952M-21, 1952M-20, 1952M-19, 1952M-18, 1952M-24, 1952M-22, 1952M-13, 1952M-12, 1952M-11, 1952M-10, 1952M-17, 1952M-16, 1952M-15, 1952M-14, 1952M-9, 1952M-8, 1952M-7, 1952M-6

BE-9778

Fit&Go 3/3 Foam Inlay Standard Combination and Ratcheting Wrench Set - 30 Pcs



FF1A3004

48 x 445 x 543 mm	1	FF1A3004

111M-24, 111M-22, 111M-17, 111M-16, 111M-15, 111M-14, 111M-21, 111M-20, 111M-19, 111M-18, 111M-9, 111M-8, 111M-7, 111M-6, 111M-13, 111M-12, 111M-11, 111M-10

1RM-19, 1RM-10, 1RM-9, 1RM-8, 1RM-14, 1RM-13, 1RM-12, 1RM-11, 1RM-18, 1RM-17, 1RM-16, 1RM-15

Fit&Go 3/3 Foam Inlay Offset Combination and Ratcheting Wrench Set - 28 Pcs



FF1A3005

38 x 445 x 543 mm	1	FF1A3005

1952M-19, 1952M-18, 1952M-22, 1952M-13, 1952M-12, 1952M-11, 1952M-10, 1952M-17, 1952M-16, 1952M-15, 1952M-14, 1952M-9, 1952M-8, 1952M-7, 1952M-6

1RM-6, 1RM-10, 1RM-9, 1RM-8, 1RM-7, 1RM-24, 1RM-22, 1RM-19, 1RM-14, 1RM-13, 1RM-12, 1RM-11, 1RM-17

Fit&Go 3/3 Foam Laser Marked Inlay ERGO™ Screwdrivers, Ratchet, Sockets & Bit Set - 22 pcs



FF1A30NB

35 x 445 x 543 mm	2.8 kg	1	FF1A30NB

BE-8020, BE-8030, BE-8040

BE-8150, BE-8155

BE-8160

BE-8611, BE-8621

BE-8811, BE-8821

BE-8910, BE-8915, BE-8920, BE-8925, BE-8930

808050S

808050

6972H

K6650-1/4-1P

6950SL

59S/31-1

SBS64

SB6963

SBS60-4, SBS60-11, SBS60-12, SBS60-13, SBS60-7, SBS60-8, SBS60-9, SBS60-10, SBS60-4.5, SBS60-5, SBS60-5.5, SBS60-6



Fit&Go 3/3 Foam Laser Marked Inlay Striking, Cutting Tools, Files & L-Keys - 28 pcs



FF1A31NB

45 x 445 x 543 mm 2.69 kg 1 FF1A31NB

317	
1-100-08-1-2	
1-210-08-1-2	
1-230-08-1-2	
MTB-3-16	
3625W-35	
481-300	
782-U	
BE-9770	
KG09-01	
KSBG09-10DISPEN	

Fit&Go 3/3 Foam Inlay Striking and File Set - 24 Pcs



FF1A35

42 x 445 x 543 mm 1 FF1A35

317	
1-100-08-1-2	
1-210-08-1-2	
1-230-08-1-2	
MTB-3-16	
3625W-35	
481-300	
782-U	
BE-9770	
KG09-01	
4040M-8-9, 4040M-10-11, 4040M-12-13, 4040M-14-15, 4040M-16-17	

Fit&Go 3/3 Foam Inlay Screwdriver/Bit/Socket Set - 89 Pcs



FF1A36

50 x 445 x 543 mm 1 FF1A36

4040M-8-9, 4040M-10-11, 4040M-12-13, 4040M-14-15, 4040M-16-17	
808050S	
808050	
6972H	
K6650-1/4-1P, 59S/H8	
6950SL	
59S/31-1	
59S/H2, 59S/H3, 59S/H4, 59S/H5, 59S/H6	
8030-2P, 8040-2P, 8242-2P, 8252-2P	
8610-2P, 8620-2P, 8630-2P	
8810-2P, 8820-2P, 8830-2P	
8910-2P, 8915-2P, 8925-2P, 8930-2P, 8940-2P	
BE-8575	
SBS60-11, SBS60-12, SBS60-13, SBS60-4, SBS60-4.5, SBS60-5, SBS60-5.5, SBS60-6, SBS60-7, SBS60-8, SBS60-9, SBS60-10	
SB6963	
SBS64	

Fit&Go 3/3 Foam Inlay Socket and Wrench Set - 46 Pcs



FF1A37

35 x 445 x 543 mm 1 FF1A37

111M-6, 111M-7, 111M-8, 111M-9, 111M-10, 111M-11, 111M-12, 111M-13, 111M-14, 111M-15, 111M-16, 111M-17, 111M-18, 111M-19, 111M-21, 111M-22, 111M-24	
8071 IP	
2101G-160	
2430 G-160	
8224	
S240NB-NR	
8150SL	

Fit&Go 3/3 Foam Inlay Socket and Wrench Set - 54 Pcs



FF1A39

45 x 445 x 543 mm 1 FF1A39

S410	
S1612L	
8071 IP	

Fit&Go 3/3 Foam Inlay Pliers Set - 12 Pcs



FF1A4001

38 x 445 x 543 mm 1 FF1A4001

1520 D	
2101G-160IP	
21HDG-200IP	
2223 G-150	

2421 G-140IP, 2421 G-180 IP	
2427 G-200 IP	
2628 G-180IP	
2681	
2951-140, 2951-300	
8224 IP	

Fit&Go 3/3 Foam Inlay Pliers Set - 11 Pcs



FF1A4002

42 x 445 x 543 mm 1 FF1A4002

2101G-160IP	
2430 G-200 IP	
2465D-200	
2628 G-160IP	
2744	
2951-140	
2952-165	
1520 G	
527 D-160	
7224	
5515FL	

Fit&Go 3/3 Foam Inlay Circlip Pliers Set - 12 Pcs



FF1A4003

35 x 445 x 543 mm 1 FF1A4003

2800-150, 2800-180, 2800-225	
2890-140, 2890-180, 2890-210	
2900-150, 2900-180, 2900-215	
2990-140, 2990-180, 2990-200	

Fit&Go 3/3 Foam Inlay Striking and Saw Set - 9 Pcs



FF1A41

42 x 445 x 543 mm 1 FF1A41

2171G-160	
2470 G-160	
2971G-250	
MTB-3-16	
WR2-12	
3625W-35	
481-300	
218	
306	

Fit&Go 3/3 Foam Inlay Spanners Set - 31 pcs



FF1A48

44 x 543 x 445 mm 1 FF1A48

1RM-6, 1RM-7, 1RM-8, 1RM-9, 1RM-10, 1RM-11, 1RM-12, 1RM-13, 1RM-14, 1RM-17, 1RM-19, 1RM-22, 1RM-24, 1RM-27	
111M-6, 111M-7, 111M-8, 111M-9, 111M-10, 111M-11, 111M-12, 111M-13, 111M-14, 111M-15, 111M-16, 111M-17, 111M-18, 111M-19, 111M-20, 111M-21, 111M-22, 111M-24, 111M-27	

Fit&Go 3/3 Foam Inlay Pliers/Wrench Set - 13 Pcs



FF1A50

45 x 445 x 543 mm 1 FF1A50

8223 IP, 8224 IP, 8225 IP	
1420	
2430 G-160 IP	
2427 G-160 IP	
8069	
9070	
9031	
2101G-160IP	
21HDG-180IP	

Fit&Go 3/3 Foam Inlay Wrench/Drift Punch Set - 27 Pcs



FF1A5002

50 x 445 x 543 mm 1 FF1A5002

111M-30, 111M-32, 111M-6, 111M-7, 111M-8, 111M-9, 111M-10, 111M-11, 111M-12, 111M-13, 111M-14, 111M-15, 111M-16, 111M-17, 111M-18, 111M-19, 111M-20, 111M-21, 111M-22, 111M-24, 111M-27	
3734S/6	



Fit&Go 3/3 Foam Inlay 1/4" + 3/8" Socket and Combination Wrench Set - 91 Pcs



FF1A5003



45 x 445 x 543 mm 1 FF1A5003

111M-13, 111M-12, 111M-10, 111M-8, 111M-19, 111M-17, 111M-15		
6700SM-5.5, 6700SM-5, 6700SM-14, 6700SM-13, 6700SM-12, 6700SM-11, 6700SM-10, 6700SM-9, 6700SM-8, 6700SM-7, 6700SM-6		
6700TORX-E5, 6700TORX-E4, 6700TORX-E10, 6700TORX-E8, 6700TORX-E7, 6700TORX-E6		
6709TORX-T27, 6709TORX-T25, 6709TORX-T20, 6709TORX-T15, 6709TORX-T10, 6709TORX-T9, 6709TORX-T8, 6709TORX-T40, 6709TORX-T30		
6950		
6961, 6962		
6966		
7400SM-13, 7400SM-12, 7400SM-11, 7400SM-10, 7400SM-9, 7400SM-8, 7400SM-21, 7400SM-19, 7400SM-18, 7400SM-17, 7400SM-16, 7400SM-15, 7400SM-14, 7400SM-22		
7400TORX-E18, 7400TORX-E16, 7400TORX-E14, 7400TORX-E12, 7400TORX-E11, 7400TORX-E10, 7400TORX-E8		
7409TORX-T30, 7409TORX-T27, 7409TORX-T25, 7409TORX-T50, 7409TORX-T45, 7409TORX-T40		
7750		
7760, 7761, 7762		
7764		
7765		
7766		
A6800DM-8, A6800DM-7, A6800DM-6, A6800DM-14, A6800DM-13, A6800DM-12, A6800DM-11, A6800DM-10, A6800DM-9		
A7402DM-19, A7402DM-18, A7402DM-17, A7402DM-16, A7402DM-15, A7402DM-14, A7402DM-13, A7402DM-12, A7402DM-11, A7402DM-10		
8157-15		

Fit&Go 3/3 Foam Inlay Wrench/Socket Set - 38 Pcs



FF1A5004



55 x 445 x 543 mm 1 FF1A5004

1RM-19, 1RM-13, 1RM-12, 1RM-11, 1RM-10, 1RM-9, 1RM-8, 1RM-27, 1RM-7, 1RM-24, 1RM-6, 1RM-22, 1RM-17		
6700SM-13, 6700SM-12, 6700SM-11, 6700SM-10, 6700SM-9, 6700SM-8, 6700SM-7, 6700SM-6		
6950		
6960		
6966		
7800SM-19, 7800SM-17, 7800SM-32, 7800SM-30, 7800SM-13, 7800SM-27, 7800SM-24, 7800SM-22		
8155-1/2		
SBS86		
6954		
8160-5		
8166		

Fit&Go 3/3 Foam Inlay Standard Combination Wrench/Socket Set - 83 Pcs



FF1A5005



50 x 445 x 543 mm 1 FF1A5005

111M-17, 111M-15, 111M-13, 111M-19, 111M-8		
6700SM-8, 6700SM-7, 6700SM-6, 6700SM-12, 6700SM-11, 6700SM-10, 6700SM-9, 6700SM-14, 6700SM-13, 6700SM-5, 6700SM-4		
6709M-5, 6709M-4, 6709M-8, 6709M-6, 6709M-3		

6950SL	
6962	
6968	
7400SM-8, 7400SM-7, 7400SM-6, 7400SM-12, 7400SM-11, 7400SM-10, 7400SM-9, 7400SM-16, 7400SM-15, 7400SM-14, 7400SM-13, 7400SM-18, 7400SM-17	
7750SL	
7760-W	
7761	
7768	
7800SM-11, 7800SM-10, 7800SM-15, 7800SM-14, 7800SM-13, 7800SM-12, 7800SM-19, 7800SM-18, 7800SM-17, 7800SM-16, 7800SM-22, 7800SM-21, 7800SM-27, 7800SM-24, 7800SM-32, 7800SM-30, 7800SM-8, 7800SM-9	
7809M-17, 7809M-14, 7809M-12, 7809M-10, 7809M-5, 7809M-6, 7809M-7, 7809M-8	
7809TORX-T40, 7809TORX-T30, 7809TORX-T25, 7809TORX-T20, 7809TORX-T45	
8150SL	
A6709M-6, A6709M-5, A6709M-4, A6709M-3, A6709M-2.5	
K6650-1/4-1P	
6960W-2, 6960W-6	
8160-5, 8160-10	
8166	

Fit&Go 3/3 Foam Inlay Files and Wrench Set - 27 Pcs



FF1A5006



54 x 445 x 543 mm 1 FF1A5006

1-100-08-2-2		
1-210-08-2-2		
1-230-06-2-2, 1-230-10-2-2		
111M-7, 111M-8, 111M-9, 111M-10, 111M-11, 111M-12, 111M-13, 111M-14, 111M-15, 111M-16, 111M-17, 111M-18, 111M-19, 111M-21, 111M-22		
1320RM-6-7, 1320RM-8-9, 1320RM-10-11, 1320RM-12-13, 1320RM-14-15, 1320RM-16-17, 1320RM-18-19, 1320RM-22-24		

Fit&Go 3/3 Foam Inlay Socket/Striking Toolset - 60 Pcs



FF1A5007

50 x 445 x 543 mm 1 FF1A5007

K6650-1/4-1P	
3734-2, 3734-3, 3734-4, 3734-5, 3734-6, 3734-8	
481-400	
6700SM-11, 6700SM-12, 6700SM-13, 6700SM-14, 6700SM-10, 6700SM-5, 6700SM-6, 6700SM-7, 6700SM-8, 6700SM-9, 6700SM-4	
6709F-8, 6709F-5.5	
6709M-3, 6709M-4, 6709M-5, 6709M-6	
6709PH-1, 6709PH-2	
6950SL	
6954	
6960, 6962	
6966	
7800SM-18, 7800SM-19, 7800SM-10, 7800SM-11, 7800SM-12, 7800SM-13, 7800SM-14, 7800SM-15, 7800SM-16, 7800SM-17, 7800SM-21, 7800SM-22, 7800SM-23, 7800SM-24, 7800SM-25, 7800SM-26, 7800SM-27, 7800SM-28, 7800SM-30, 7800SM-32	
8072 IP	
B145.006.100	
8150SL	
8224 IP	
8154-11	
8160-5, 8160-10	
8166	

Fit&Go 3/3 Foam Inlay Adjustable Wrench/Striking/Measuring Toolset - 24 Pcs



FF1A5008

50 x 445 x 543 mm 1 FF1A5008

1-100-08-2-2	
1-160-08-2-2	

1-170-08-2-2	
1-210-08-2-2	
1-230-08-2-2	
1150D	
1450D-ISO	
1547	
3625N-40	
3734-2, 3734-3, 3734-4, 3734-5, 3734-6, 3734-8	
3735-4-120, 3735-5-150	
3740-125, 3740-150	
38-20	
5515T	
9029, 9031	
MTB-3-16	

Fit&Go 3/3 Foam Inlay Insulated Wrench/Pliers/Screwdriver Set - 17 Pcs



FF1A5009

38 x 445 x 543 mm 1 FF1A5009

2101S-160	
2223 S-150	
2250V-170	
2430 S-200	
2628 S-180	
8072V	
BE-8220S, BE-8040S, BE-8050S, BE-8255S, BE-8065S	
BE-8340	
BE-8601	
BE-8610S, BE-8620S	
BE-8810S, BE-8820S	

Fit&Go 3/3 Foam Inlay Adjustable Wrench/Striking/File/Pliers Set - 22 Pcs



FF1A5010

35 x 445 x 543 mm 1 FF1A5010

1-100-08-1-2	
1-160-08-1-2	
1-170-08-2-2	
1-210-08-1-2	
1-230-08-1-2	
2101G-180IP	
2427 G-200 IP	
2430 G-200 IP	
2628 G-180IP	
3733-2, 3733-4, 3733-6	
3734-2, 3734-3, 3734-4, 3734-5, 3734-6, 3734-8	
3735-4-120	
481-300	
8069 IP	
9031	

Fit&Go 3/3 Foam Inlay Pliers/Striking/File/Screwdriver Set - 27 Pcs



FF1A5011

44 x 445 x 543 mm 1 FF1A5011

1-476-04-3-2	
1178-SCRIBE	
1547	
2101G-160IP	
2427 G-160 IP	
2430 G-160 IP	
3734-2, 3734-3, 3734-4, 3734-5, 3734-6, 3734-8	
3735-5-120	
481-500	
BE-8020L, BE-8040	
BE-8150, BE-8255, BE-8256	
BE-8610, BE-8620	
MTB-3-16	



Fit&Go 3/3 Foam Inlay Striking and Measuring Toolset - 13 Pcs



FF1A5012



48 x 445 x 543 mm



1 FF1A5012



141	
3734-2, 3734-3, 3734-4, 3734-5, 3734-6	
479-08	
481-1000, 481-300	
782-U	
MTS-5-25	
SQZ150003	
319	

Fit&Go 3/3 Foam Inlay Socket/Combination Wrench Set - 41 Pcs



FF1A5013



50 x 445 x 543 mm



1 FF1A5013



111M-6, 111M-7, 111M-8, 111M-9, 111M-12, 111M-13, 111M-17, 111M-10, 111M-11, 111M-19, 111M-20, 111M-22, 111M-24, 111M-27, 111M-32, 111M-30	
6700SM-6, 6700SM-7, 6700SM-8, 6700SM-9, 6700SM-10, 6700SM-11, 6700SM-12, 6700SM-13, 6700SM-14	
6950	
6960	
6966	
7800SM-19, 7800SM-17, 7800SM-13, 7800SM-22, 7800SM-27, 7800SM-24, 7800SM-30, 7800SM-32	
8155-1/2	
SBS86	
6954	
8160-5	
8166	

Fit&Go 3/3 Foam Inlay Screwdriver/Hacksaw Set - 17 Pcs



FF1A5015



45 x 445 x 543 mm



1 FF1A5015



319	
268	
208	
2509	
2444	
2744	
5515T	
BE-8020L, BE-8040	
BE-8150, BE-8255, BE-8256	
BE-8340	
BE-8601	
BE-8610, BE-8620	
MTB-5-25	

Fit&Go 3/3 Foam Inlay Screwdriver/Wrench Set - 16 Pcs



FF1A5017



35 x 445 x 543 mm



1 FF1A5017



3734-2, 3734-3, 3734-4, 3734-5, 3734-6, 3734-8	
3735-5-120	
3740-175	
481-400	
111M-21, 111M-22, 111M-24, 111M-27, 111M-32, 111M-30	
3625N-32	

Fit&Go 3/3 Foam Inlay Wrench/Pliers/Socket Set - 47 Pcs



FF1A5019



52 x 445 x 543 mm



1 FF1A5019



111M-17, 111M-18, 111M-19, 111M-20, 111M-6, 111M-7, 111M-8, 111M-13, 111M-14, 111M-15, 111M-16, 111M-9, 111M-10, 111M-11, 111M-12	
2101G-160IP	
2430 G-160 IP	
2628 G-180IP	
7800DM-12, 7800DM-13, 7800DM-14, 7800DM-15, 7800DM-10, 7800DM-11, 7800DM-20, 7800DM-21, 7800DM-22, 7800DM-23, 7800DM-16, 7800DM-17, 7800DM-18, 7800DM-19, 7800DM-28, 7800DM-30, 7800DM-32, 7800DM-24, 7800DM-25, 7800DM-26, 7800DM-27, 7800DM-8, 7800DM-9	
8155-1/2	
8224 IP	
8154-11	
8160-5, 8160-10	
8166	

Fit&Go 3/3 Foam Inlay Screwdriver/Cutting Tool Set - 17 Pcs



FF1A5021



45 x 445 x 543 mm



1 FF1A5021



BE-8020L, BE-8040		
BE-8150, BE-8255, BE-8256		
BE-8340		
BE-8601		
BE-8610, BE-8620		
319		
MTB-5-25		
2444		
268		
5515T		
2509		
2744		
208		

Fit&Go 3/3 Foam Inlay Screwdriver/Cutting Tool Set - 16 Pcs



FF1A5023

45 x 445 x 543 mm 1 FF1A5023

208	
2444	
2509	
268	
2744	
319	
5515T	
BE-8020L, BE-8040	
BE-8150, BE-8255, BE-8256	
BE-8340	
BE-8601	
BE-8610, BE-8620	

Fit&Go 3/3 Foam Inlay Pliers/Wrench/Socket Set - 26 Pcs



FF1A5022

50 x 445 x 543 mm 1 FF1A5022

6700SM-4.5, 6700SM-5, 6700SM-5.5, 6700SM-6, 6700SM-7, 6700SM-8, 6700SM-9, 6700SM-10, 6700SM-11, 6700SM-12, 6700SM-13, 6700SM-14, 6700SM-4		
6950		
6954		
6956		
6960, 6962		
6966		
8070		
9031		
9072 P		
141		
2101G-160IP		
2430 G-160 IP		
2628 G-180IP		
8224 IP		

Fit&Go 3/3 Foam Inlay Wrench and Pliers Set - 28 Pcs



FF1A5024

45 x 445 x 543 mm 1 FF1A5024

111M-12, 111M-13, 111M-6, 111M-7, 111M-8, 111M-9, 111M-10, 111M-11		
1RM-17, 1RM-18, 1RM-19, 1RM-8, 1RM-9, 1RM-10, 1RM-11, 1RM-12, 1RM-13, 1RM-14, 1RM-15, 1RM-16		
2101G-160IP		
2430 G-160 IP		
141		
2628 G-180IP		
9031		

9072 P	
8070	
8224 IP	

Fit&Go 3/3 Foam Inlay Socket/Wrench Set - 36 Pcs



FF1A5027

44 x 445 x 543 mm 1 FF1A5027

2M-20-22, 2M-21-23, 2M-24-27, 2M-25-28, 2M-30-32		
4040M-10-11, 4040M-12-13, 4040M-14-15, 4040M-16-17, 4040M-18-19, 4040M-20-22, 4040M-21-23, 4040M-8-9		
7400SM-6, 7400SM-7, 7400SM-12, 7400SM-13, 7400SM-14, 7400SM-15, 7400SM-8, 7400SM-9, 7400SM-10, 7400SM-11, 7400SM-20, 7400SM-21, 7400SM-22, 7400SM-16, 7400SM-17, 7400SM-18, 7400SM-19		
7754		
7755-3/8		
7760, 7761, 7762		
7766		

Fit&Go 3/3 Foam Inlay Socket/Wrench Set - 32 Pcs



FF1A5028

45 x 445 x 543 mm 1 FF1A5028

111M-6, 111M-7, 111M-8, 111M-9, 111M-10, 111M-11, 111M-14, 111M-15, 111M-16, 111M-17, 111M-18, 111M-19, 111M-20, 111M-12, 111M-13		
1419-MD		
BE-8906, BE-8907, BE-8908, BE-8909, BE-8910, BE-8915, BE-8920, BE-8925, BE-8927, BE-8930, BE-8940, BE-8945		
7805DM-12, 7805DM-13, 7805DM-17, 7805DM-10, 7805DM-19		



Fit&Go 3/3 Foam Inlay Pliers/Wrench Set - 29 Pcs



FF1A5029



40 x 445 x 543 mm	1	FF1A5029

2628 G-180IP	
2101G-160IP	
2430 G-160 IP	
8224 IP	
BBR201P6	
BE5103	
2M-10-11, 2M-12-13, 2M-14-15, 2M-16-17, 2M-18-19, 2M-6-7, 2M-8-9	
7809TORX-T50, 7809TORX-T55, 7809TORX-T25, 7809TORX-T30, 7809TORX-T40, 7809TORX-T45	

Fit&Go 3/3 Foam Inlay Screw/Socket Driver Set - 62 Pcs



FF1A5031



48 x 445 x 543 mm	1	FF1A5031

1419-MD	
7809M-10, 7809M-12, 7809M-14, 7809M-17, 7809M-19, 7809M-7, 7809M-8, 7809M-5, 7809M-9, 7809M-6	
BE-9678	
7809M-10-140, 7809M-5-180, 7809M-6-140, 7809M-7-100, 7809M-8-120	
59S/31-1	
808050	
7805DM-12, 7805DM-13, 7805DM-17, 7805DM-19, 7805DM-10	

Fit&Go 3/3 Foam Inlay Socket/Wrench/Grip Set - 45 Pcs



FF1A5030



52 x 445 x 543 mm	1	FF1A5030

111M-17, 111M-18, 111M-19, 111M-20, 111M-6, 111M-7, 111M-8, 111M-13, 111M-14, 111M-15, 111M-16, 111M-9, 111M-10, 111M-11, 111M-12	
2951-180, 2951-250	
7800DM-12, 7800DM-13, 7800DM-14, 7800DM-15, 7800DM-8, 7800DM-9, 7800DM-10, 7800DM-11, 7800DM-20, 7800DM-21, 7800DM-22, 7800DM-23, 7800DM-16, 7800DM-17, 7800DM-18, 7800DM-19, 7800DM-28, 7800DM-30, 7800DM-32, 7800DM-24, 7800DM-26, 7800DM-27	
8155-1/2	
3625N-32	
8154-11	
8160-5, 8160-10	
8166	

Fit&Go 3/3 Foam Inlay Socket and Wrench Set - 75 Pcs



FF1A5032



55 x 445 x 543 mm	1	FF1A5032

6700SM-10, 6700SM-11, 6700SM-8, 6700SM-9, 6700SM-14, 6700SM-12, 6700SM-13, 6700SM-4, 6700SM-6, 6700SM-7, 6700SM-5, 6700SM-4.5, 6700SM-5.5	
6950	
6954	
6956	
6960, 6962	
6966	
7400SM-6, 7400SM-7, 7400SM-10, 7400SM-11, 7400SM-8, 7400SM-9, 7400SM-14, 7400SM-15, 7400SM-12, 7400SM-13, 7400SM-18, 7400SM-19, 7400SM-16, 7400SM-17, 7400SM-22, 7400SM-20, 7400SM-21	
7754	

7755-3/8



7760, 7761, 7762



7766



7800DM-11, 7800DM-14, 7800DM-15, 7800DM-12, 7800DM-13, 7800DM-18, 7800DM-19, 7800DM-16, 7800DM-17, 7800DM-22, 7800DM-23, 7800DM-20, 7800DM-21, 7800DM-26, 7800DM-27, 7800DM-24, 7800DM-30, 7800DM-32, 7800DM-28, 7800DM-8, 7800DM-9, 7800DM-10, 7800DM-25, 7800DM-29



8155-1/2



111M-19, 111M-17, 111M-18, 111M-15, 111M-16, 111M-14, 111M-20



8154-11



8160-5, 8160-10



8166



Fit&Go 3/3 Foam Inlay Hose Clamp Set - 6 Pcs



FF1A5036



38 x 445 x 543 mm	1	FF1A5036

BE258	
BE250	
BE256P3	
BE254A	

Fit&Go 3/3 Foam Inlay 1/2" Impact Wrench Set - 12 Pcs



FF1A5037



75 x 445 x 543 mm	1	FF1A5037

BPC813	
BP814A	
BP824	
BP110	
BP118	

Fit&Go 3/3 Foam Inlay Calliper Set for Brake - 50 Pcs



FF1A5038



45 x 445 x 543 mm



1 FF1A5038



BBR300P50



Fit&Go 3/3 Foam Inlay File/Pliers/Punch Set - 23 Pcs



FF1A51



40 x 445 x 543 mm



1 FF1A51



1-100-08-1-2		
1-210-08-1-2		
1-230-08-1-2		
4-144-08-2-2		
1-170-08-1-2		
3735-4-120		
3733-4, 3733-2, 3733-6		
3734-2, 3734-3, 3734-4, 3734-5, 3734-6, 3734-8		
2800-180, 2800-150		
2890-140, 2890-180		
2900-150, 2900-180		
2990-140, 2990-180		

Fit&Go 3/3 Foam Inlay Screwdriver/Key Set - 38 Pcs



FF1A53



45 x 445 x 543 mm



1 FF1A53



BE-8800, BE-8811, BE-8821		
BE-8830		
BE-8600, BE-8611, BE-8621		
BE-8630		
BE-8910, BE-8915, BE-8920, BE-8925		
BE-9770		
BE-9780		
3625S-44		
2800-225		
2890-210		

Fit&Go 3/3 Foam Inlay 1/4" + 3/8" Long Socket Set - 75 Pcs



FF1A54



35 x 445 x 543 mm



1 FF1A54



S1612L		
S0810L		
S330L		

Fit&Go 3/3 Foam Inlay Wrench/Bit Set - 75 Pcs



FF1A55



40 x 445 x 543 mm



1 FF1A55



A6700DZ-1/2, A6700DZ-1/4, A6700DZ-11/32, A6700DZ-3/16, A6700DZ-3/8, A6700DZ-5/16, A6700DZ-7/16, A6700DZ-7/32, A6700DZ-9/16, A6700DZ-9/32		
--	--	--

BE-9775		
SBS61		
SBS63-2, SBS63-6, SBS63-4		
SBS65		
SBS67		
SBS81		
6956		
6972H		
7800DZ-1, 7800DZ-1/2, 7800DZ-11/16, 7800DZ-13/16, 7800DZ-15/16, 7800DZ-19/32, 7800DZ-3/4, 7800DZ-3/8, 7800DZ-5/8, 7800DZ-7/8, 7800DZ-9/16, 7800DZ-7/16		
808050		
6954		
8160-10, 8160-5		
8166		
8154-11		

Fit&Go 3/3 Foam Inlay Combination Wrench Set - 28 Pcs



FF1A56



63 x 445 x 543 mm



1 FF1A56



111Z-1, 111Z-1/2, 111Z-1/4, 111Z-11/16, 111Z-13/16, 111Z-15/16, 111Z-3/4, 111Z-3/8, 111Z-5/16, 111Z-5/8, 111Z-7/16, 111Z-7/8, 111Z-9/16		
1320RZ-1/2-9/16, 1320RZ-1/4-5/16, 1320RZ-3/8-7/16, 1320RZ-5/16-11/32		
6Z-1.1/16-1.1/4, 6Z-1-1.1/8, 6Z-1/2-9/16, 6Z-1/4-5/16, 6Z-15/16-1, 6Z-19/32-11/16, 6Z-25/32-13/16, 6Z-5/16-11/32, 6Z-5/8-3/4, 6Z-7/8-15/16		
9031		



Fit&Go 3/3 Foam Inlay Wrenches/Hand Hacksaw Set - 28 Pcs



FF1A65



50 x 445 x 543 mm

1 FF1A65

111M-19, 111M-17, 111M-18, 111M-24,
111M-21, 111M-22, 111M-7, 111M-8,
111M-6, 111M-11, 111M-12, 111M-9,
111M-10, 111M-15, 111M-16, 111M-13,
111M-14, 111M-20

1RM-8, 1RM-9, 1RM-12, 1RM-13, 1RM-
10, 1RM-11, 1RM-17, 1RM-14, 1RM-19

319

Fit&Go 3/3 Foam Inlay Screwdriver/
Wrench/Pliers Set - 28 Pcs



FF1A67



39 x 445 x 543 mm

1 FF1A67

9031

2101G-160IP

21HDG-180IP

2427 G-160 IP

2430 G-160 IP

8224 IP

BE-8600, BE-8611, BE-8621

BE-8630

BE-8910, BE-8915, BE-8920, BE-8925

7865

Fit&Go 3/3 Foam Inlay Measuring Tape
and Screwdriver Set - 50 Pcs



FF1A66



50 x 445 x 543 mm

1 FF1A66

038.055.100, 038.065.125, 038.080.150

039.001.100, 039.002.125

1178-SCRIBE

426TOR9

6972H

9045-B-250

BE-8010S, BE-8230S

BE-8040

BE-8150, BE-8155

BE-8800, BE-8811, BE-8821

BE-8830

MTB-5-25

SQZ150003

59S/31-1

Fit&Go 3/3 Foam Inlay Files/Striking/Circlip
Pliers/Hex Key Set - 30 Pcs



FF1A68



37 x 445 x 543 mm

1 FF1A68

1-100-08-1-2

1-170-08-1-2

1-210-08-1-2

1-230-08-1-2

2800-180

2890-180

2900-180

2990-180

3733-4, 3733-2, 3733-6

3734-8, 3734-5, 3734-6, 3734-3, 3734-
4, 3734-2

3735-4-120

4-144-08-2-2

481-400

BE-9770

Fit&Go 3/3 Foam Inlay Automotive Bit Set
and Clamping Tip Set - 105 Pcs



FF1A70



42 x 445 x 543 mm

1 FF1A70

BE5049

S560

Fit&Go 3/3 Foam Inlay Slotted/Phillips/T-
Handle Screwdriver Set - 45 Pcs



FF1A71



41 x 445 x 543 mm

1 FF1A71

901T-010-100, 901T-015-150, 901T-
020-150, 901T-027-150, 901T-030-200,
901T-040-200, 901T-025-150, 901T-
045-200, 901T-050-200

B190.055.125

B191.030.075, B191.040.100

B192.001.100, B192.002.125

B705.1/4.125

59/S31B

BAHCO

Fit&Go 3/3 Foam Inlay Automotive Pliers Set - 18 Pcs



FF1A72

38 x 445 x 543 mm	1	FF1A72

2101GC-160IP	
2430 GC-200 IP	
2630GC-180IP	
2800-180	
2890-180	
2900-180	
2953-200	
2990-180	
3640-200-C	
3734N-10-150, 3734N-2-150, 3734N-3-150, 3734N-4-150, 3734N-5-150, 3734N-6-150, 3734N-8-150	
479-16	
3625W-35	

Fit&Go 3/3 Foam Inlay Striking, Cutting, Pliers & Measuring Tape - 25 pcs



FF1A82

43 x 445 x 543 mm	1	FF1A82

3734S/6	
479-16	
3625W-35	
MTG-3-16	
KB18-01	
KSBG18-10DISPEN	
2101G-180IP	
2678 G-180	
2470 G-200	
720031	
8224 IP	

Fit&Go 2/3 Foam Inlay Slotted Screwdriver Set - 9 Pcs



ergo®



FF1F1001

40 x 362 x 445 mm	1	FF1F1001

BE-8210, BE-8030, BE-8040, BE-8240, BE-8242, BE-8252, BE-8250L	
BE-8255, BE-8257	

Fit&Go 2/3 Foam Inlay Phillips Screwdriver Set - 11 Pcs



ergo®



FF1F1002

40 x 362 x 445 mm	1	FF1F1002

BE-8020, BE-8040, BE-8242, BE-8252	
BE-8330	
BE-8256, BE-8258	
BE-8610, BE-8620, BE-8623	
BE-8602	

Fit&Go 2/3 Foam Inlay Slotted/Phillips Screwdriver Set - 11 Pcs



ergo®



FF1F1003

38 x 362 x 445 mm	1	FF1F1003

BE-8030, BE-8242, BE-8252	
BE-8155	
BE-8870	
BE-8600, BE-8610, BE-8620, BE-8623, BE-8624	
808050S	

Fit&Go 2/3 Foam Inlay TORX® Screwdriver Set - 10 Pcs



ergo®



FF1F1004

38 x 362 x 445 mm	1	FF1F1004

BE-8904, BE-8907, BE-8908	
BE-7910, BE-7915, BE-7920, BE-7925, BE-7927, BE-7930, BE-7940	

Fit&Go 2/3 Foam Inlay TORX®/Bit Screwdriver Set - 12 Pcs



FF1F1005

43 x 362 x 445 mm	1	FF1F1005

BE-8908, BE-8909, BE-8910, BE-8915, BE-8920, BE-8925, BE-8927, BE-8930	
K6650-1/4-1P	
808050S	
808050	
59S/31-3	



Fit&Go 2/3 Foam Inlay 3/8" Standard/Deep Socket Set - 34 Pcs



FF1F2102

40 x 362 x 445 mm
1 FF1F2102

S330L

Fit&Go 2/3 Foam Inlay 3/8" Socket Set - 38 Pcs

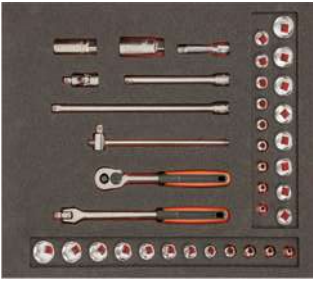

FF1F2103

35 x 362 x 445 mm
1 FF1F2103

S380

Fit&Go 2/3 Foam Inlay 1/2" Socket and Round Head Ratchet Set - 35 Pcs



FF1F2201

50 x 362 x 445 mm
1 FF1F2201

7800SM-10, 7800SM-12, 7800SM-13,
7800SM-17, 7800SM-18, 7800SM-19,
7800SM-20, 7800SM-21, 7800SM-22,
7800SM-24, 7800SM-27, 7800SM-30,
7800SM-32

7800DM-10, 7800DM-11, 7800DM-12,
7800DM-13, 7800DM-14, 7800DM-15,
7800DM-16, 7800DM-17, 7800DM-18,
7800DM-19

7809M-5, 7809M-6, 7809M-7, 7809M-8,
7809M-10, 7809M-12

8150SL

8160-5, 8160-10

8166

8154-11

8171

Fit&Go 2/3 Foam Inlay 1/2" Socket and Pear Head Ratchet Set - 24 Pcs



FF1F2202

50 x 362 x 445 mm
1 FF1F2202

S240

S81SL

Fit&Go 2/3 Foam Inlay Bit Set/Magnetic Dish Set - 50 Pcs



FF1F5004

35 x 362 x 445 mm
1 FF1F5004

BE5049

1419-MD

Fit&Go 2/3 Foam Inlay Turnbuckle Shock Absorber Set - 39 Pcs



FF1F5013

35 x 362 x 445 mm
1 FF1F5013

BS1000

Fit&Go 2/3 Foam Inlay 1/2" Deep Impact Socket Set - 27 Pcs



FF1F2203

50 x 362 x 445 mm
1 FF1F2203

K7801M-10, K7801M-12, K7801M-13,
K7801M-14, K7801M-15, K7801M-16,
K7801M-17, K7801M-18, K7801M-19,
K7801M-21, K7801M-22, K7801M-24

K7806M-10, K7806M-12, K7806M-13,
K7806M-14, K7806M-15, K7806M-16,
K7806M-17, K7806M-18, K7806M-19,
K7806M-21, K7806M-22, K7806M-24,
K7806M-27, K7806M-30, K7806M-32

Fit&Go 2/3 Foam Inlay Double Open End Wrench Set - 11 Pcs



FF1F3001

40 x 362 x 445 mm
1 FF1F3001

6M-6-7, 6M-8-9, 6M-10-11, 6M-12-13, 6M-14-15,
6M-16-18, 6M-17-19, 6M-20-22, 6M-21-23, 6M-
24-27, 6M-30-32



Fit&Go 2/3 Foam Inlay Combination Wrench Set - 18 Pcs



FF1F3002



41 x 362 x 445 mm



1 FF1F3002

111M-6, 111M-7, 111M-8, 111M-9, 111M-10, 111M-11, 111M-12, 111M-13, 111M-14, 111M-15, 111M-16, 111M-17, 111M-18, 111M-19, 111M-21, 111M-22, 111M-24, 111M-27

Fit&Go 2/3 Foam Inlay Combination Wrench Set - 30 Pcs



FF1F3003



40 x 362 x 445 mm



1 FF1F3003

111M-6, 111M-7, 111M-8, 111M-9, 111M-10, 111M-11, 111M-12, 111M-13, 111M-14, 111M-15, 111M-16, 111M-17, 111M-18, 111M-19, 111M-20, 111M-21, 111M-22

1320SRM-14-19

1RMA-19-1/4-SQ

1RMA-19-1/2-SQ2

1RMA-13-10-BIT

BE-9778

Fit&Go 2/3 Foam Inlay Imperial Combination Wrench Set - 13 Pcs



FF1F3004



42 x 362 x 445 mm



1 FF1F3004

111Z-3/8, 111Z-11/16, 111Z-1, 111Z-1/2, 111Z-13/16, 111Z-5/16, 111Z-5/8, 111Z-15/16, 111Z-7/16, 111Z-3/4, 111Z-1/4, 111Z-9/16, 111Z-7/8

Fit&Go 2/3 Foam Inlay Combination Ratchet Wrench Set - 15 Pcs



FF1F3005



39 x 362 x 445 mm



1 FF1F3005

1RM-8, 1RM-10, 1RM-12, 1RM-13, 1RM-14, 1RM-15, 1RM-16, 1RM-17, 1RM-18, 1RM-19, 1RM-21, 1RM-22

1RMA-13-10-BIT

1RMA-19-1/2-SQ2

Fit&Go 2/3 Foam Inlay Combination Ratchet Wrench Set - 17 Pcs



FF1F3006



35 x 362 x 445 mm



1 FF1F3006

1RM-19, 1RM-21, 1RM-22, 1RM-24, 1RM-27, 1RM-30

Fit&Go 2/3 Foam Inlay Double Open Ring Offset Wrench Set - 10 Pcs



FF1F3007



47 x 362 x 445 mm



1 FF1F3007

2M-6-7, 2M-8-9, 2M-10-11, 2M-12-13, 2M-14-15, 2M-16-18, 2M-17-19, 2M-21-23, 2M-24-27, 2M-30-32

Fit&Go 2/3 Foam Inlay Double Socket Head Wrench Set - 9 Pcs



FF1F3008



38 x 362 x 445 mm



1 FF1F3008

4040M-6-7, 4040M-8-9, 4040M-10-11, 4040M-12-13, 4040M-14-15, 4040M-16-17, 4040M-18-19, 4040M-20-22, 4040M-21-23

Fit&Go 2/3 Foam Inlay Flare Nut Wrench Set - 8 Pcs



FF1F3009



35 x 362 x 445 mm



1 FF1F3009

1949M-8-9, 1949M-10-11, 1949M-12-13, 1949M-14-15, 1949M-17-19, 1949M-19-22, 1949M-24-27, 1949M-30-32



Fit&Go 2/3 Foam Inlay Combination Wrench Set - 17 Pcs



FF1F3010



35 x 362 x 445 mm

1 FF1F3010

1RM/S5



111M/SH12



Fit&Go 2/3 Foam Inlay Metric Combination Wrench and Ratcheting Ring Wrench Set - 13 Pcs



FF1F3011



35 x 362 x 445 mm

1 FF1F3011

S4RM/3T



111M/SH12



Fit&Go 2/3 Foam Inlay Wrench and Pliers Set - 8 Pcs



FF1F4001



35 x 362 x 445 mm

1 FF1F4001

2430 G-160 IP



2421 G-180 IP



2101G-160IP



2628 G-200



8224 IP



9029



2951-140, 2951-300



Fit&Go 2/3 Foam Inlay Scissors and Pliers Set - 8 Pcs



FF1F4002



35 x 362 x 445 mm

1 FF1F4002

2928-160



2951-250



SC127



2101G-160IP



2430 G-160 IP



2339 DIP



2628 G-180IP



8224 IP



Fit&Go 2/3 Foam Inlay Pliers Set - 4 Pcs



FF1F4003

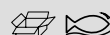

35 x 362 x 445 mm

1 FF1F4003

2101G-160IP



8224 IP



2951-180



2430 G-200 IP



Fit&Go 2/3 Foam Inlay Circlip Pliers Set - 8 Pcs



FF1F4004



35 x 362 x 445 mm

1 FF1F4004

2800-140, 2800-180



2890-140, 2890-180



2900-140, 2900-180



2990-140, 2990-180



Fit&Go 2/3 Foam Inlay Insulated Cutter/Pliers Set - 5 Pcs



FF1F4005



38 x 362 x 445 mm

1 FF1F4005

2101S-160



2430 S-200



2427 S-200



8224 IP



2628 S-180



Fit&Go 2/3 Foam Inlay File/Measuring Tape/Pliers Set - 10 Pcs



FF1F5001



40 x 362 x 445 mm	1	FF1F5001	

1-100-08-1-2		
1-160-08-1-2		
1-170-08-1-2		
1-210-08-1-2		
1-230-08-1-2		
2430 G-200 IP		
2628G-200IP		
7224		
2101G-160IP		
MTB-3-16		

Fit&Go 2/3 Foam Inlay Tin Snip/Rivet Gun/Measuring Tape Set - 5 Pcs



FF1F5002



38 x 362 x 445 mm	1	FF1F5002	

2681	
MA401	
MA411	
1178-SCRIBE	
MTG-5-19	

Fit&Go 2/3 Foam Inlay Pliers/Adjustable Wrench Set - 5 Pcs



FF1F5003



35 x 362 x 445 mm	1	FF1F5003

8224	
2101G-160	
2430 G-160	
8071	
2951-250	

Fit&Go 2/3 Foam Inlay Cutting Tool Set - 8 Pcs



FF1F5005



40 x 362 x 445 mm	1

317	
3906-300-24-5P	
268	
2446	

Fit&Go 2/3 Foam Inlay End Terminal Pliers/Multimeter Set - 4 Pcs



FF1F5006



50 x 362 x 445 mm	1	FF1F5006

CR W 01	
CR B 05	
3418 A	
BMMTRMS1	

Fit&Go 2/3 Foam Inlay Puller Set - 5 Pcs



FF1F5007



45 x 362 x 445 mm	1

4543-1, 4543-2, 4543-3	
4545-2	
4541-A	

Fit&Go 2/3 Foam Inlay Knife/Awl/Hook Set - 11 Pcs



FF1F5008



37 x 362 x 445 mm	1	FF1F5008	

2633/S4, 2633L/S4	
2489	
2485	
KE18-01	

Fit&Go 2/3 Foam Inlay Puller/Joint Fork Set - 5 Pcs



FF1F5009



60 x 362 x 445 mm

1 FF1F5009

BS618, BS623

4545-2

4545-N11

4532-0

Fit&Go 2/3 Foam Inlay Mix Brush/Ring Wrench Set - 9 Pcs



FF1F5010



45 x 362 x 445 mm

1 FF1F5010

BBR6135

BBR6131

BBR110

1949M-8-9, 1949M-10-11

7809M-6, 7809M-8, 7809M-10

783

Fit&Go 2/3 Foam Inlay 1/2" Impact Wrench Set - 7 Pcs



FF1F5011



100 x 362 x 445 mm

1 FF1F5011

BP815

BP821

BP822

BP823

Fit&Go 2/3 Foam Inlay 1/2" Mini Impact Wrench Set - 9 Pcs



FF1F5012



55 x 362 x 445 mm

1 FF1F5012

BWSS12P317, BWSS12P319, BWSS12P321

BPC814

BWTB12P120

GL008-10

783

8157-15

Fit&Go 1/3 Foam Inlay 4 Slotted/3 Phillips Screwdriver Set - 7 Pcs



FF1E1001



38 x 181 x 445 mm

1 FF1E1001

BE-8030, BE-8040, BE-8242, BE-8252

BE-8610, BE-8620, BE-8623

Fit&Go 1/3 Foam Inlay 5 Slotted/2 Phillips Screwdriver Set - 7 Pcs



FF1E1002



39 x 181 x 445 mm

1 FF1E1002

BE-8242, BE-8040, BE-8030

BE-8257, BE-8255

BE-8611, BE-8621

Fit&Go 1/3 Foam Inlay Slotted/Pozidriv Screwdriver Set - 6 Pcs



FF1E1003



38 x 181 x 445 mm

1 FF1E1003

BE-8240

BE-8150, BE-8255, BE-8256

BE-8810, BE-8820

Fit&Go 1/3 Foam Inlay Slotted/Phillips/Pozidriv Screwdriver Set - 8 Pcs



FF1E1004



40 x 181 x 445 mm

1 FF1E1004

BE-8340, BE-8350

BE-8600, BE-8610

BE-8811, BE-8800, BE-8820L, BE-8821



Fit&Go 1/3 Foam Inlay Slotted/Phillips/
Poizidriv/Hex Screwdriver Set - 7 Pcs



ergo



FF1E1005



40 x 181 x 445 mm 1 FF1E1005

- | | | |
|---------------------------|--|--|
| BE-8210, BE-8010 | | |
| BE-8811, BE-8821, BE-8800 | | |
| BE-8600 | | |
| BE-8830 | | |

Fit&Go 1/3 Foam Inlay Slotted/Phillips/
Poizidriv Screwdriver Set - 6 Pcs



ergo



FF1E1006



40 x 181 x 445 mm 1 FF1E1006

- | | | |
|------------------|--|--|
| BE-8210 | | |
| BE-8610, BE-8620 | | |
| BE-8630 | | |
| BE-8811, BE-8820 | | |

Fit&Go 1/3 Foam Inlay TORX® Screwdriver
Set T10-T40 - 6 Pcs



ergo



FF1E1007



40 x 181 x 445 mm 1 FF1E1007

- | | | |
|---|--|--|
| BE-8910, BE-8915, BE-8920, BE-8925,
BE-8930, BE-8940 | | |
|---|--|--|

Fit&Go 1/3 Foam Inlay TORX® Tamper-
Resistant Screwdriver Set TR10-TR40 - 6
Pcs



ergo



FF1E1008



38 x 181 x 445 mm 1 FF1E1008

- | | | |
|---|--|--|
| BE-7910, BE-7930, BE-7925, BE-7920,
BE-7915, BE-7940 | | |
|---|--|--|

Fit&Go 1/3 Foam Inlay TORX® Screwdriver
Set T8-T30 - 6 Pcs



ergo



FF1E1009



38 x 181 x 445 mm 1 FF1E1009

- | | | |
|---|--|--|
| BE-8908, BE-8910, BE-8915, BE-8920,
BE-8925, BE-8930 | | |
|---|--|--|

Fit&Go 1/3 Foam Inlay Slotted/Phillips
Insulated Screwdriver Set 39 mm x 181
mm x 445 mm - 6 Pcs



ergo



FF1E1010



39 x 181 x 445 mm 1 FF1E1010

- | | | |
|---|--|--|
| BE-8010S, BE-8230S, BE-8050S,
BE-8255S | | |
| BE-8610S, BE-8620S | | |

Fit&Go 1/3 Foam Inlay Slotted/Phillips
Insulated Screwdriver Set 45 mm x 181
mm x 445 mm - 6 Pcs



ergo



FF1E1011



45 x 181 x 445 mm 1 FF1E1011

- | | | |
|---|--|--|
| BE-8040S, BE-8050S, BE-8255S,
BE-8065S | | |
| BE-8610S, BE-8620S | | |

Fit&Go 1/3 Foam Inlay 1/4" Socket and
Pear Head Ratchet Set - 37 Pcs



FF1E2001



38 x 181 x 445 mm 1 FF1E2001

- | | | |
|--|--|--|
| 6700SM-4, 6700SM-5, 6700SM-5.5,
6700SM-6, 6700SM-7, 6700SM-8,
6700SM-9, 6700SM-10, 6700SM-11,
6700SM-12, 6700SM-13, 6700SM-14 | | |
| 6700TORX-E4, 6700TORX-E5,
6700TORX-E6, 6700TORX-E7,
6700TORX-E8, 6700TORX-E10 | | |
| 6709M-3, 6709M-4, 6709M-5, 6709M-6,
6709M-8 | | |
| 6709TORX-T8, 6709TORX-T9,
6709TORX-T10, 6709TORX-T15,
6709TORX-T20, 6709TORX-T25,
6709TORX-T30, 6709TORX-T27,
6709TORX-T40 | | |
| 6950SL | | |
| 6954 | | |
| 6956 | | |
| 6960 | | |
| 6966 | | |

Fit&Go 1/3 Foam Inlay 1/4" Socket and Pear Head Ratchet Set - 45 Pcs



FF1E2002



38 x 181 x 445 mm

1 FF1E2002

- 6700SM-4, 6700SM-4.5, 6700SM-5, 6700SM-5.5, 6700SM-6, 6700SM-7, 6700SM-8, 6700SM-9, 6700SM-10, 6700SM-11, 6700SM-12, 6700SM-13, 6700SM-14
- 6709PZ-1, 6709PZ-3, 6709PZ-2
- 6709PH-1, 6709PH-2, 6709PH-3
- 6709TORX-T10, 6709TORX-T15, 6709TORX-T20, 6709TORX-T25, 6709TORX-T30, 6709TORX-T40
- 6709F-4.5, 6709F-5.5, 6709F-8
- 6709M-3, 6709M-4, 6709M-5, 6709M-6, 6709M-8
- 1998M-3, 1998M-2.5, 1998M-2, 1998M-1.5
- 6950SL
- 6962-W
- 6966
- 6956
- 6960, 6961
- 7765
- 6954

Fit&Go 1/3 Foam Inlay 1/4" Socket and Pear Head Ratchet Set - 19 Pcs



FF1E2003



38 x 181 x 445 mm

1 FF1E2003

- 6700SM-5, 6700SM-5.5, 6700SM-6, 6700SM-7, 6700SM-8, 6700SM-9, 6700SM-10, 6700SM-11, 6700SM-12, 6700SM-13, 6700SM-14
- BE-9778
- 6950SL
- 6956
- 6962

6966

7765

6954

1998M-12

Fit&Go 1/3 Foam Inlay 1/4" Socket and Pear Head Ratchet Set - 48 Pcs



FF1E2004



44 x 181 x 445 mm

1 FF1E2004

- A6700DM-8, A6700DM-9, A6700DM-10, A6700DM-11, A6700DM-12, A6700DM-13, A6700DM-14, A6700DM-5, A6700DM-5.5, A6700DM-6, A6700DM-7
- 808050S
- 6950SL
- 6966
- 6972H
- 6962
- 7765
- 59S/31-1

Fit&Go 1/3 Foam Inlay 1/4" Socket and Pear Head Ratchet Set - 17 Pcs



FF1E2005



35 x 181 x 445 mm

1 FF1E2005

- 6700SM-5.5, 6700SM-6, 6700SM-7, 6700SM-8, 6700SM-9, 6700SM-10, 6700SM-11, 6700SM-12, 6700SM-13, 6700SM-14
- 6950RN
- 6962, 6960
- 6966
- 6954
- 6956
- 6972H

Fit&Go 1/3 Foam Inlay 1/4" Socket and Round Head Ratchet Set - 35 Pcs



FF1E2006



39 x 181 x 445 mm

1 FF1E2006

- 6700SZ-5/16, 6700SZ-5/32, 6700SZ-11/32, 6700SZ-7/16, 6700SZ-9/32, 6700SZ-3/16, 6700SZ-3/8, 6700SZ-7/32, 6700SZ-1/4, 6700SZ-1/2, 6700SZ-9/16
- 6709PZ-1, 6709PZ-2, 6709PZ-3
- 6709PH-1, 6709PH-2, 6709PH-3
- 6709TORX-T8, 6709TORX-T10, 6709TORX-T15, 6709TORX-T20, 6709TORX-T25, 6709TORX-T30
- 6709F-4.5, 6709F-6.5, 6709F-8
- 6950RN
- 6954
- 6972H
- 6960, 6962
- 6963
- 6966
- 6956
- 7765

Fit&Go 1/3 Foam Inlay 1/4" Socket and Round Head Ratchet Set - 24 Pcs



FF1E2007



35 x 181 x 445 mm

1 FF1E2007

- 6700SZ-9/32, 6700SZ-3/16, 6700SZ-3/8, 6700SZ-1/4, 6700SZ-7/16, 6700SZ-7/32, 6700SZ-1/2, 6700SZ-11/32
- 1995Z-5/64, 1995Z-5/32, 1995Z-3/8, 1995Z-3/32, 1995Z-7/32, 1995Z-1/8, 1995Z-5/16, 1995Z-3/16, 1995Z-1/4
- 6950RN
- 6954
- 6972H
- 6960, 6962
- 6956
- 6966



Fit&Go 1/3 Foam Inlay 1/4" Socket and Round Head Ratchet Set - 26 Pcs



FF1E2008



35 x 181 x 445 mm 1 FF1E2008

6700SM-5.5, 6700SM-6, 6700SM-7, 6700SM-8, 6700SM-9, 6700SM-10, 6700SM-11, 6700SM-12, 6700SM-13, 6700SM-14		
1995M-2, 1995M-3, 1995M-4, 1995M-5, 1995M-6, 1995M-7, 1995M-8, 1995M-9, 1995M-10		
6950RN		
6960, 6962		
6966		
6954		
6956		
6972H		

Fit&Go 1/3 Foam Inlay 3/8" Socket and Pear Head Ratchet Set - 25 Pcs



FF1E2102

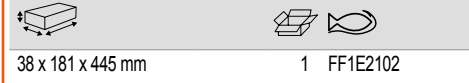

38 x 181 x 445 mm 1 FF1E2102

7400SM-6, 7400SM-7, 7400SM-8, 7400SM-9, 7400SM-10, 7400SM-11, 7400SM-12, 7400SM-13, 7400SM-14, 7400SM-15, 7400SM-16, 7400SM-17, 7400SM-18, 7400SM-19		
7409M-4, 7409M-5, 7409M-6, 7409M-8, 7409M-10		
7750SL		
7760, 7762		
7754		
7768		
8164-1/2		

Fit&Go 1/3 Foam Inlay 3/8" Socket and Round Head Ratchet Set - 20 Pcs



FF1E2104

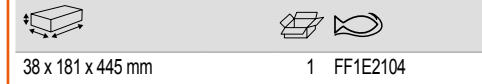

38 x 181 x 445 mm 1 FF1E2104

7400SM-6, 7400SM-8, 7400SM-9, 7400SM-10, 7400SM-11, 7400SM-12, 7400SM-13, 7400SM-14, 7400SM-15, 7400SM-16, 7400SM-17, 7400SM-18, 7400SM-19, 7400SM-20, 7400SM-22		
7750RN		
7761, 7762		
7766		
7768		

Fit&Go 1/3 Foam Inlay 3/8" Socket and Pear Head Ratchet Set - 24 Pcs



FF1E2101



40 x 181 x 445 mm 1 FF1E2101

7400SM-6, 7400SM-7, 7400SM-8, 7400SM-9, 7400SM-10, 7400SM-11, 7400SM-12, 7400SM-13, 7400SM-14, 7400SM-15, 7400SM-16, 7400SM-17, 7400SM-18, 7400SM-19, 7400SM-20, 7400SM-22		
7750SL		
7760, 7761, 7762		
7764		
7766		
7754		
8164-1/2		

Fit&Go 1/3 Foam Inlay 3/8" Socket and Pear Head Ratchet Set - 28 Pcs



FF1E2103



38 x 181 x 445 mm 1 FF1E2103

7400SM-7, 7400SM-8, 7400SM-9, 7400SM-10, 7400SM-11, 7400SM-12, 7400SM-13, 7400SM-14, 7400SM-15, 7400SM-16, 7400SM-17, 7400SM-18, 7400SM-19, 7400SM-20, 7400SM-21, 7400SM-22		
7400TORX-E8, 7400TORX-E10, 7400TORX-E12, 7400TORX-E14, 7400TORX-E16, 7400TORX-E18		
7750SL		
7760, 7762		
7768		
7766		
SBS705		

Fit&Go 1/3 Foam Inlay 3/8" Socket and Bit Driver Set - 28 Pcs



FF1E2105



35 x 181 x 445 mm 1 FF1E2105

7400TORX-E8, 7400TORX-E10, 7400TORX-E11, 7400TORX-E12, 7400TORX-E14, 7400TORX-E16, 7400TORX-E18		
7409TORX-T25, 7409TORX-T30, 7409TORX-T40, 7409TORX-T45, 7409TORX-T50		
7409TORX-T25-L, 7409TORX-T30-L, 7409TORX-T40-L, 7409TORX-T45-L, 7409TORX-T50-L		
7409M-4, 7409M-5, 7409M-6, 7409M-8, 7409M-10		
7409F-6.5, 7409F-8, 7409F-10		
7409PH-1, 7409PH-2, 7409PH-3		

Fit&Go 1/3 Foam Inlay 1/2" Socket and Round Head Ratchet Set - 21 Pcs



FF1E2201



44 x 181 x 445 mm 1 FF1E2201

- 7800SM-10, 7800SM-11, 7800SM-12, 7800SM-13, 7800SM-14, 7800SM-15, 7800SM-17, 7800SM-18, 7800SM-19, 7800SM-20, 7800SM-21, 7800SM-22, 7800SM-24, 7800SM-27
- 7805SM-16, 7805SM-21
- 8150SL
- 8160-5, 8160-10
- 8166
- 8171

Fit&Go 1/3 Foam Inlay 1/2" Socket and Pear Head Ratchet Set - 21 Pcs



FF1E2202



45 x 181 x 445 mm 1 FF1E2202

- 7800SM-8, 7800SM-9, 7800SM-10, 7800SM-11, 7800SM-12, 7800SM-13, 7800SM-14, 7800SM-15, 7800SM-16, 7800SM-17, 7800SM-18, 7800SM-19, 7800SM-20, 7800SM-21, 7800SM-23, 7800SM-24, 7800SM-27
- 8150-1/2
- 8160-5, 8160-10
- 8166

Fit&Go 1/3 Foam Inlay 1/2" Socket and Round Head Ratchet Set - 22 Pcs



FF1E2203



50 x 181 x 445 mm 1 FF1E2203

- 7800SM-8, 7800SM-9, 7800SM-10, 7800SM-11, 7800SM-12, 7800SM-13, 7800SM-14, 7800SM-15, 7800SM-16, 7800SM-17, 7800SM-18, 7800SM-19, 7800SM-22, 7800SM-21, 7800SM-24, 7800SM-27, 7800SM-30, 7800SM-32
- 8150RN-1/2
- 8160-5, 8160-10
- 8166

Fit&Go 1/3 Foam Inlay 1/2" Socket and Round Head Ratchet Set - 15 Pcs



FF1E2204



45 x 181 x 445 mm 1 FF1E2204

- 7800DZ-1/2, 7800DZ-3/4, 7800DZ-19/32, 7800DZ-7/8, 7800DZ-7/16, 7800DZ-11/16, 7800DZ-9/16, 7800DZ-13/16, 7800DZ-3/8, 7800DZ-5/8, 7800DZ-15/16
- 8150RN-1/2
- 8160-5, 8160-10
- 8166

Fit&Go 1/3 Foam Inlay 1/2" Socket Set - 28 Pcs



FF1E2205



50 x 181 x 445 mm 1 FF1E2205

- 7800DM-10, 7800DM-11, 7800DM-12, 7800DM-13, 7800DM-14, 7800DM-15, 7800DM-16, 7800DM-17, 7800DM-18, 7800DM-19, 7800DM-20, 7800DM-21, 7800DM-22, 7800DM-23, 7800DM-24, 7800DM-25, 7800DM-26, 7800DM-27, 7800DM-28, 7800DM-30, 7800DM-32
- 7809M-6, 7809M-7, 7809M-8, 7809M-9, 7809M-10, 7809M-12, 7809M-14

Fit&Go 1/3 Foam Inlay 1/2" Socket Set - 27 Pcs



FF1E2206



50 x 181 x 445 mm 1 FF1E2206

- 7800SM-10, 7800SM-11, 7800SM-12, 7800SM-13, 7800SM-14, 7800SM-15, 7800SM-16, 7800SM-17, 7800SM-18, 7800SM-19, 7800SM-20, 7800SM-21, 7800SM-22, 7800SM-23, 7800SM-24, 7800SM-25, 7800SM-26, 7800SM-27, 7800SM-28, 7800SM-30, 7800SM-32
- 7809XZN-8, 7809XZN-10
- 7809PZ-2, 7809PZ-3
- 7809F-8, 7809F-10



Fit&Go 1/3 Foam Inlay 1/2" Socket Set/Bit Set/Key Set - 25 Pcs



FF1E2207



40 x 181 x 445 mm

1 FF1E2207

7809TORX-T20, 7809TORX-T25,
7809TORX-T27, 7809TORX-T30,
7809TORX-T40, 7809TORX-T55,
7809TORX-T45, 7809TORX-T50,
7809TORX-T60



7800TORX-E8, 7800TORX-E10,
7800TORX-E12, 7800TORX-E14,
7800TORX-E16, 7800TORX-E18,
7800TORX-E20, 7800TORX-E24



BE-9675



Fit&Go 1/3 Foam Inlay 1/2" Bit Driver Set - 12 Pcs



FF1E2208



35 x 181 x 445 mm

1 FF1E2208

7809M-6, 7809M-7, 7809M-8, 7809M-9,
7809M-10, 7809M-12, 7809M-14,
7809M-17



7809M-5-180, 7809M-6-140, 7809M-8-120,
7809M-10-140



Fit&Go 1/3 Foam Inlay 1/2" Bit Driver Set - 20 Pcs



FF1E2209



35 x 181 x 445 mm

1 FF1E2209

7809M-5, 7809M-6, 7809M-7, 7809M-8,
7809M-10, 7809M-12, 7809M-14,
7809M-17



7809TORX-T25, 7809TORX-T27,
7809TORX-T30, 7809TORX-T40,
7809TORX-T45, 7809TORX-T50,
7809TORX-T55, 7809TORX-T60



7809XZN-6, 7809XZN-8, 7809XZN-10,
7809XZN-12



Fit&Go 1/3 Foam Inlay 1/2" Bit Driver Set/Impact Socket Set - 14 Pcs



FF1E2210



38 x 181 x 445 mm

1 FF1E2210

7809M-5, 7809M-6, 7809M-7, 7809M-8,
7809M-10, 7809M-12, 7809M-14,
7809M-17, 7809M-19



BE-7606, BE-7607



BWSS12P317, BWSS12P319,
BWSS12P321



Fit&Go 1/3 Foam Inlay 1/2" Socket Set - 21 Pcs



FF1E2211



50 x 181 x 445 mm

1 FF1E2211

7993S0050, 7993S0060, 7993S0080,
7993S0100, 7993S0120, 7993S0140,
7993S0170, 7993S0190



7994S0300, 7994S0400, 7994S0450,
7994S0500, 7994S0550, 7994S0600



K7801TORX-E10, K7801TORX-E12,
K7801TORX-E14, K7801TORX-E16,
K7801TORX-E18, K7801TORX-E20,
K7801TORX-E24



Fit&Go 1/3 Foam Inlay 1/2" Socket Set - 12 Pcs



FF1E2212

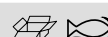

40 x 181 x 445 mm

1 FF1E2212

K7801M-10, K7801M-12, K7801M-13,
K7801M-14, K7801M-15, K7801M-16,
K7801M-17, K7801M-18, K7801M-19,
K7801M-21, K7801M-22, K7801M-24



Fit&Go 1/3 Foam Inlay 1/2" Power Deep Socket Set - 15 Pcs



FF1E2213

45 x 181 x 445 mm 1 FF1E2213

K7806M-10, K7806M-12, K7806M-13, K7806M-14, K7806M-15, K7806M-16, K7806M-17, K7806M-18, K7806M-19, K7806M-21, K7806M-22, K7806M-24, K7806M-27, K7806M-30, K7806M-32

Fit&Go 1/3 Foam Inlay 1/2" Socket Set - 13 Pcs



FF1E2501

35 x 181 x 445 mm 1 FF1E2501

A7402DM-10, A7402DM-11, A7402DM-12, A7402DM-13, A7402DM-14
7805SM-12, 7805SM-13, 7805SM-14, 7805SM-15, 7805SM-16, 7805SM-17, 7805SM-18, 7805SM-19

Fit&Go 1/3 Foam Inlay 1/2" to 3/4" Power Socket Set - 7 Pcs



FF1E2502

45 x 181 x 445 mm 1 FF1E2502

K560F-4, K560F-5
K8167S
K8160D-1, K8160D-2
K7764D
K8964D

Fit&Go 1/3 Foam Inlay Socket/Extractor Set - 35 Pcs



FF1E5005

36 x 181 x 445 mm 1 FF1E5005

BWTSP16
1418S

Fit&Go 1/3 Foam Inlay Socket/Torsion Bar Set - 6 Pcs



FF1E5006

42 x 181 x 445 mm 1 FF1E5006

D/S14
BWSS12P3
BWTB12P120, BWTB12P110

Fit&Go 1/3 Foam Inlay Mix Oil Plug Socket Set - 17 Pcs



FF1E5009

36 x 181 x 445 mm 1 FF1E5009

BE6217

Fit&Go 1/3 Foam Inlay Double Open End Wrench Set - 8 Pcs



FF1E3001

47 x 181 x 445 mm 1 FF1E3001

6M-6-7, 6M-8-9, 6M-10-11, 6M-12-13, 6M-14-15, 6M-16-17, 6M-18-19, 6M-21-23, 6M-22-24

Fit&Go 1/3 Foam Inlay Double Open End Wrench Set - 3 Pcs



FF1E3002

35 x 181 x 445 mm 1 FF1E3002

6M-25-28, 6M-27-29, 6M-30-32



Fit&Go 1/3 Foam Inlay Double Open End Wrench Set - 9 Pcs



FF1E3003

41 x 181 x 445 mm 1 FF1E3003

6Z-1/2-9/16, 6Z-15/16-1, 6Z-5/16-11/32, 6Z-5/8-3/4, 6Z-3/8-7/16, 6Z-25/32-13/16, 6Z-19/32-11/16, 6Z-1/4-5/16, 6Z-3/4-7/8

Fit&Go 1/3 Foam Inlay Combination Ratcheting Wrench Set - 10 Pcs



FF1E3004

39 x 181 x 445 mm 1 FF1E3004

1RM-10, 1RM-9, 1RM-8, 1RM-14, 1RM-13, 1RM-12, 1RM-11, 1RM-17, 1RM-16, 1RM-15

Fit&Go 1/3 Foam Inlay Combination Ratcheting Wrench Set - 40 Pcs



FF1E3005

42 x 181 x 445 mm 1 FF1E3005

59S/31-1
6966
41RM-8, 41RM-10, 41RM-12, 41RM-13, 41RM-14, 41RM-17, 41RM-19
8166

Fit&Go 1/3 Foam Inlay Ratcheting Wrench Set - 8 Pcs



FF1E3006

35 x 181 x 445 mm 1 FF1E3006

1320RM-6-7, 1320RM-8-9, 1320RM-10-11, 1320RM-12-13, 1320RM-14-15, 1320RM-16-17, 1320RM-18-19, 1320RM-22-24

Fit&Go 1/3 Foam Inlay Double Open Ring Offset Wrench Set - 7 Pcs



FF1E3007

35 x 181 x 445 mm 1 FF1E3007

2M-6-7, 2M-8-9, 2M-10-11, 2M-12-13, 2M-14-15, 2M-16-17, 2M-18-19

Fit&Go 1/3 Foam Inlay Double Open End Pipe Wrench Set - 9 Pcs



FF1E3008

50 x 181 x 445 mm 1 FF1E3008

27M-8-9, 27M-10-11, 27M-12-13, 27M-14-15, 27M-16-17, 27M-18-19, 27M-20-22, 27M-21-23, 27M-24-27

Fit&Go 1/3 Foam Inlay Pliers Set - 4 Pcs



ergo



FF1E4001

35 x 181 x 445 mm 1 FF1E4001

2628 G-180IP

8231 IP

2430 G-200 IP

2101G-160IP

Fit&Go 1/3 Foam Inlay Circlip Pliers Set - 4 Pcs



FF1E4002

35 x 181 x 445 mm 1 FF1E4002

2900-180

2890-180

2990-180

2800-180

Fit&Go 1/3 Foam Inlay Wrench and Pliers Set - 3 Pcs



ergo



FF1E5007

38 x 181 x 445 mm 1 FF1E5007

1410

9033

8225

Fit&Go 1/3 Foam Inlay Measuring Tool Set - 7 Pcs



FF1E5001

45 x 181 x 445 mm 1 FF1E5001

- MTB-5-25
- 8045LVDE
- WR2-MM
- 1544
- 1178-SCRIBE
- 5515T
- 1150D

Fit&Go 1/3 Foam Inlay Hammer/Punch/Impact Driver Set - 35 Pcs



FF1E5004

36 x 181 x 445 mm 1 FF1E5004

- 481-400
- 3734S/6
- 7865

Fit&Go 1/3 Foam Inlay Hammer/Flat Chisel/Cotter Pin Punch Set - 11 Pcs



FF1E5002

35 x 181 x 445 mm 1 FF1E5002

- 3740-150, 3740-175, 3740-200
- 3734-2, 3734-3, 3734-4, 3734-5, 3734-6, 3734-8
- 481-100
- 1157

Fit&Go 1/3 Foam Inlay Hammer/Flat Chisel/Drift Punch Set - 11 Pcs



FF1E5003

35 x 181 x 445 mm 1 FF1E5003

- 481-300
- 3735-5-120
- 3739-300
- 3740-100, 3740-125, 3740-150, 3740-200
- 3733-2, 3733-3, 3733-4, 3733-5

Fit&Go 1/3 Foam Inlay Spark Plug Socket and Pliers Set - 4 Pcs



FF1E5008

37 x 181 x 445 mm 1 FF1E5008

- 7805ZZ-16, 7805ZZ-21
- BE1P
- BE61110

Fit&Go 1/3 Foam Inlay ERGO™ Blade Screwdriver Set - 6 pcs Retail Pack



FF1E1012EH

55 x 185 x 480 mm 1 FF1E1012EH

- BE-8030
- BE-8150
- BE-8621, BE-8611
- BE-8811, BE-8821

Fit&Go 1/3 Foam Inlay Torx® Screwdriver Set T8-T30 - 6 pcs Retail Pack



FF1E1009EH

55 x 185 x 480 mm 1 FF1E1009EH

- BE-8908, BE-8910, BE-8915, BE-8920, BE-8925, BE-8930

Fit&Go 1/3 Foam Inlay ERGO™ Through Blade Screwdriver Set - 6 pcs Retail Pack



FF1E1013EH

55 x 185 x 480 mm 1 FF1E1013EH

- BE-8135TB, BE-8145TB, BE-8150TB, BE-8155TB
- BE-8810TB, BE-8820TB



Fit&Go 1/3 Foam Inlay 1/4" Socket Set & Bit Set - 46 pcs Retail Pack



FF1E2009EH

55 x 185 x 480 mm 1 FF1E2009EH

59/S31B-IP		
6700SM-4, 6700SM-4.5, 6700SM-5, 6700SM-5.5, 6700SM-6, 6700SM-7, 6700SM-8, 6700SM-9, 6700SM-10, 6700SM-11, 6700SM-12, 6700SM-13		
6962-W		
6972H		
6950SL		

Fit&Go 1/3 Foam Inlay 1/4" Deep Socket Set - 11 pcs Retail Pack



FF1E2214EH

55 x 185 x 480 mm 1 FF1E2214EH

S0810L		
1419-MD		

Fit&Go 1/3 Foam Inlay 3/8" Socket Set - 18 pcs Retail Pack



FF1E2106EH

55 x 185 x 480 mm 1 FF1E2106EH

7400SM-10, 7400SM-11, 7400SM-12, 7400SM-13, 7400SM-14, 7400SM-15, 7400SM-16, 7400SM-17, 7400SM-18, 7400SM-19, 7400SM-20, 7400SM-22		
7760, 7761		
7766		
SBS750		
7402GPR-16, 7402GPR-21		

Fit&Go 1/3 Foam Inlay 1/2" Socket Set - 21 pcs Retail Pack



FF1E2215EH

55 x 185 x 480 mm 1 FF1E2215EH

7800SM-10, 7800SM-11, 7800SM-12, 7800SM-13, 7800SM-14, 7800SM-15, 7800SM-16, 7800SM-17, 7800SM-18, 7800SM-19, 7800SM-20, 7800SM-21, 7800SM-22, 7800SM-23, 7800SM-24, 7800SM-27, 7800SM-30, 7800SM-32		
8150SL		
8174A		
8166		

Fit&Go 1/3 Foam Inlay 3/8" Deep Socket Set - 14 pcs Retail Pack



FF1E2107EH

55 x 185 x 480 mm 1 FF1E2107EH

S1214L		
--------	--	--

Fit&Go 1/3 Foam Inlay 1/2" Deep Socket Set - 12 pcs Retail Pack



FF1E2503EH

55 x 185 x 480 mm 1 FF1E2503EH

S1612L		
--------	--	--

Fit&Go 1/3 Foam Inlay Bit Set - 49 pcs Retail Pack



BE5049

55 x 185 x 480 mm 1 BE5049

BE5049		
--------	--	--

Fit&Go 1/3 Foam Inlay Combination Spanners Set - 11 pcs Retail Pack



FF1E3009EH

55 x 185 x 480 mm 1 FF1E3009EH

111M-8, 111M-10, 111M-11, 111M-12, 111M-13, 111M-14, 111M-15, 111M-16, 111M-17, 111M-18, 111M-19		
--	--	--

Fit&Go 1/3 Foam Inlay 1RM Ratcheting Spanners Set - 5 pcs Retail Pack



FF1E3010EH

55 x 185 x 480 mm 1 FF1E3010EH

- 1RM-8, 1RM-10, 1RM-13, 1RM-17, 1RM-19

Fit&Go 1/3 Foam Inlay Magnetic Dish & Adjustable Spanners Set - 4 pcs Retail Pack



FF1E3011EH

55 x 185 x 480 mm 1 FF1E3011EH

- 8070 IP, 8071 IP, 8072 IP
- 1419-MD

Fit&Go 1/3 Foam Inlay Pliers Set - 3 pcs Retail Pack



FF1E4003EH

55 x 185 x 480 mm 1 FF1E4003EH

- 8224 IP
- 2101G-160IP
- 2430 G-160 IP

Fit&Go 1/3 Foam Inlay Rivet Gun & Metal Shears Set - 4 pcs Retail Pack



FF1E4004EH

55 x 185 x 480 mm 1 FF1E4004EH

- 2681
- MA401
- MA411
- 1178-SCRIBE

Fit&Go 1/3 Foam Inlay Hammer, Pin Punches & Impact Driver Set - 23 pcs Retail Pack



FF1E5010EH

55 x 185 x 480 mm 1 FF1E5010EH

- 481-400
- 3734-2, 3734-3, 3734-4, 3734-5, 3734-6, 3734-8
- 3735-5-120
- 7865

Fit&Go 1/3 Foam Inlay Circlip Pliers Set - 4 pcs Retail Pack



FF1E4005EH

55 x 185 x 480 mm 1 FF1E4005EH

- 2800-150, 2800-180
- 2900-150, 2900-180

Fit&Go 1/3 Foam Inlay Awls, Hooks & Knives - 11 pcs Retail Pack



FF1E5011EH

55 x 185 x 480 mm 1 FF1E5011EH

- 2633/S4, 2633L/S4
- 2489
- 2485
- KE18-01

Fit&Go 1/3 Foam Inlay L-Keys, Bit Set & Magnetic Dish - 36 pcs Retail Pack



FF1E5013EH

55 x 185 x 480 mm 1 FF1E5013EH

- BE-9770
- 2058/S26
- 1419-MD

Fit&Go 1/3 Foam Inlay 1/4" Socket Set - 25 pcs Retail Pack



FF1E2011EH

55 x 185 x 480 mm 1 FF1E2011EH

- SL25



Fit&Go 1/3 Foam Inlay 1/2" Ratchet & Accessories Set - 24 pcs Retail Pack



FF1E2216EH

55 x 185 x 480 mm	1 FF1E2216EH

SBS81	
S240NB-NR	

Fit&Go 1/3 Foam Inlay 1/4" & 3/8" Socket Set - 33 pcs Retail Pack



FF1E2504EH

55 x 185 x 480 mm	1 FF1E2504EH

S330	
------	--

Fit&Go 1/3 Foam Inlay 1/4" & 3/8" Socket Set - 34 pcs Retail Pack



FF1E2505EH

55 x 185 x 480 mm	1 FF1E2505EH

S330AF	
--------	--

Fit&Go 1/3 Foam Inlay Adjustable Spanner, Slip Joint Pliers & Metal Cutting Set - 8 pcs Retail Pack



FF1E5014EH

55 x 185 x 480 mm	1 FF1E5014EH	

9031P	
8224	
208	
3906-300-24-5P	

1/3 Empty Foam with Cavities and Hanger



FF1E5016EH

35 x 181 x 445 mm	1 FF1E5016EH

Fit&Go 1/3 Foam Inlay ERGO™ Files Set - 4 pcs Retail Pack

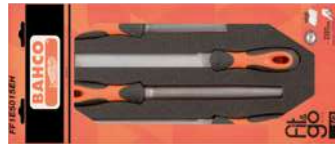

FF1E5015EH

55 x 185 x 480 mm	1 FF1E5015EH

1-100-08-2-2	
1-210-08-2-2	
4-138-08-1-2	
4-272-05-3-2	

RIGID CASES

Heavy Duty Rigid Case General Purpose Toolkit - 162 Pcs



4750RCWD4FF1

453 x 340 x 575 mm	1 4750RCWD4FF1

4750RCWD4	
6700SM-10, 6700SM-9, 6700SM-12, 6700SM-11, 6700SM-6, 6700SM-8, 6700SM-7, 6700SM-13	
A6800DM-13, A6800DM-12, A6800DM-9, A6800DM-8, A6800DM-11, A6800DM-10, A6800DM-5.5, A6800DM-7, A6800DM-6	
6709M-3, 6709M-8, 6709M-6, 6709M-5, 6709M-4	
6709PH-1, 6709PH-3, 6709PH-2	
6709TORX-T30, 6709TORX-T27, 6709TORX-T40, 6709TORX-T15, 6709TORX-T10, 6709TORX-T25, 6709TORX-T20, 6709TORX-T9, 6709TORX-T8	
6950SL	
6954	
6956	
6958	
6960, 6962, 6962L	
6966	
6972H	
7764	
7800SM-25, 7800SM-24, 7800SM-27, 7800SM-26, 7800SM-21, 7800SM-23, 7800SM-22, 7800SM-17, 7800SM-16, 7800SM-19, 7800SM-18, 7800SM-13, 7800SM-12, 7800SM-15, 7800SM-14, 7800SM-9, 7800SM-8, 7800SM-11, 7800SM-10, 7800SM-28, 7800SM-32, 7800SM-30	
7809TORX-T45, 7809TORX-T25, 7809TORX-T50, 7809TORX-T30, 7809TORX-T27, 7809TORX-T40	
8150RN-1/2	
111M-30, 111M-32, 111M-27, 111M-29, 111M-24, 111M-19, 111M-18, 111M-21, 111M-15, 111M-14, 111M-17, 111M-16, 111M-11, 111M-10, 111M-13, 111M-12, 111M-7, 111M-6, 111M-9, 111M-8	
9070C	
BE-9770	

2058-BR	
1544	
MTB-3-16	
2101G-160IP	
2427 G-200 IP	
2430 G-200 IP	
2628 G-160IP	
8224 IP	
1150-1/2H/P	
5515T-52	
2820EF2	
481-300	
3625W-35	
3734-3, 3734-5, 3734-8	
3735-4-120	
1177-SCRIBE	
BFLA01	
8160-3, 8160-5, 8160-10	
8166	
8157-15	
8154-11	

Heavy Duty Rigid Case Insulated Tool Kit - 79 pcs



4750RCHDW02RF1V

290 x 480 x 630 mm 1 4750RCHDW02RF1V

4750RCHDW02RED	
8150-1/2V	
BMMTRMS1	
28MV-10, 28MV-15, 28MV-16, 28MV-21, 28MV-22, 28MV-12, 28MV-13	
2101S-160, 2101S-180	
2101S-200	
2223 S-150	
2820VDE	
BE-8040S, BE-8050S, BE-8010S, BE-8065S	
BE-8703S, BE-8704S, BE-8725S, BE-8705S, BE-8706S, BE-8708S	

BE-8910S, BE-8915S, BE-8920S, BE-8925S, BE-8930S	
SC127V	
1999MV-5, 1999MV-6, 1999MV-7, 1999MV-8, 1999MV-9, 1999MV-10, 1999MV-12	
2430V-160, 2430V-200	
2678V-180, 2678V-160, 2678V-200	
3416 A	
806-1-1	
BE-8600S, BE-8610S, BE-8620S, BE-8630S, BE-8640S	
527V-160	
2427V-200	
2MV-10, 2MV-11, 2MV-12, 2MV-13, 2MV-14, 2MV-15, 2MV-16, 2MV-17, 2MV-18, 2MV-19	
WR1-MM	
7800DMV-8, 7800DMV-10, 7800DMV-11, 7800DMV-12, 7800DMV-13, 7800DMV-14, 7800DMV-15, 7800DMV-16, 7800DMV-17, 7800DMV-18, 7800DMV-19, 7800DMV-20, 7800DMV-21, 7800DMV-22	
2820VPC	
8162-1/2V	
7224S	

Heavy Duty Rigid Case MRO Toolkit - 195 Pcs



4750RCHDW02FF1

275 x 460 x 600 mm 1 4750RCHDW02FF1

4750RCHDW02	
6700SM-12, 6700SM-13, 6700SM-10, 6700SM-11, 6700SM-8, 6700SM-9, 6700SM-6, 6700SM-7, 6700SM-5.5	
A6800DM-13, A6800DM-11, A6800DM-12, A6800DM-9, A6800DM-10, A6800DM-7, A6800DM-8, A6800DM-5.5, A6800DM-6	
6709M-3, 6709M-4, 6709M-8, 6709M-5, 6709M-6	
6709PH-1, 6709PH-2, 6709PH-3	
6709TORX-T8, 6709TORX-T30, 6709TORX-T40, 6709TORX-T25, 6709TORX-T27, 6709TORX-T15, 6709TORX-T20, 6709TORX-T9, 6709TORX-T10	

6950SL	
6954	
6956	
6958	
6960, 6962, 6962L	
6966	
6972H	
7764	
7800SM-13, 7800SM-14, 7800SM-11, 7800SM-12, 7800SM-9, 7800SM-10, 7800SM-8, 7800SM-32, 7800SM-30, 7800SM-27, 7800SM-28, 7800SM-25, 7800SM-26, 7800SM-23, 7800SM-24, 7800SM-21, 7800SM-22, 7800SM-19, 7800SM-17, 7800SM-18, 7800SM-15, 7800SM-16	
7805SM-22, 7805SM-23, 7805SM-21, 7805SM-18, 7805SM-19, 7805SM-16, 7805SM-17, 7805SM-14, 7805SM-15, 7805SM-12, 7805SM-13, 7805SM-10, 7805SM-32, 7805SM-30, 7805SM-26, 7805SM-24, 7805SM-29, 7805SM-28, 7805SM-25, 7805SM-20	
7809TORX-T30, 7809TORX-T40, 7809TORX-T25, 7809TORX-T27, 7809TORX-T50, 7809TORX-T45	
8150RN-1/2	
111M-23, 111M-24, 111M-21, 111M-22, 111M-19, 111M-17, 111M-18, 111M-15, 111M-16, 111M-13, 111M-14, 111M-11, 111M-12, 111M-9, 111M-10, 111M-7, 111M-8, 111M-6, 111M-32, 111M-29, 111M-30, 111M-27, 111M-28, 111M-26, 111M-25	
1RM-18, 1RM-19, 1RM-16, 1RM-17, 1RM-14, 1RM-15, 1RM-12, 1RM-13, 1RM-10, 1RM-11, 1RM-8, 1RM-9, 1RM-6, 1RM-7	
9070C	
BE-9770	
BE-8571	
2058-BR	
2509	
1544	
2101G-160IP	
2427 G-200 IP	
2430 G-200 IP	
2628 G-160IP	
8224 IP	
1150-1/2H/P	
5515T-52	
2820EF2	
481-300	
3625W-35	
3734-3, 3734-5, 3734-8	
3735-4-120	
1177-SCRIBE	
2535F1	
BFLA01	
MTB-3-16	
8160-3, 8160-5, 8160-10	
8166	
8154-11	
8157-15	



Heavy Duty Rigid Case Windpower Toolkit - 167 Pcs



4750RCHDW02FF2



480 x 290 x 630 mm



1 4750RCHDW02FF2

4750RCHDW02		
6700SM-12, 6700SM-13, 6700SM-10, 6700SM-11, 6700SM-8, 6700SM-9, 6700SM-6, 6700SM-7, 6700SM-5.5		
6954		
6956		
6958		
6960, 6961, 6962, 6962L		
6966		
6972H		
6950SL		
7800SM-13, 7800SM-14, 7800SM-11, 7800SM-12, 7800SM-10, 7800SM-32, 7800SM-30, 7800SM-27, 7800SM-24, 7800SM-21, 7800SM-19, 7800SM-17, 7800SM-18, 7800SM-15, 7800SM-16, 7800SM-22		
7809M-7, 7809M-6, 7809M-17, 7809M-19, 7809M-5, 7809M-14, 7809M-12, 7809M-10, 7809M-8		
7809TORX-T60, 7809TORX-T40, 7809TORX-T55, 7809TORX-T50, 7809TORX-T45		
59S/31-1		
8150SL		
111M-24, 111M-21, 111M-19, 111M-17, 111M-18, 111M-15, 111M-16, 111M-13, 111M-14, 111M-11, 111M-12, 111M-9, 111M-10, 111M-7, 111M-8, 111M-6, 111M-32, 111M-29, 111M-30, 111M-27		
BE-9770		
1177-SCRIBE		

6M-6-7, 6M-8-9, 6M-10-11, 6M-12-13, 6M-14-15, 6M-16-17, 6M-18-19, 6M-20-22, 6M-24-27, 6M-30-32	
MTB-3-16-E	
9070, 9072	
2535L	
BE-8020L, BE-8030	
BE-8155	
BE-8260	
BE-8610, BE-8620	
BE-8630	
BE-8810, BE-8820	
BE-8830	
1544	
2047-0.8-4	
TAH2047PR-1-2	
2058-BR	
2509	
808050P	
808050S	
BE-8220S, BE-8040S, BE-8050S	
BE-8610S, BE-8620S	
2535F2	
1150-1/2H/P	
2101G-160IP	
2427 G-200 IP	
2430 G-200 IP	
2628 G-160IP	
2820EF2	
5515T-52	
8224 IP	
BFLA01	
3625W-35	
3734-3, 3734-5, 3734-8	
3735-4-120	
481-300	
3680	
3875-RL1	
3875-WL1	
4750-3PB-2	
3750	
8157-15	
8154-11	
8160-5, 8160-10	
8171	
8166	

Heavy Duty Rigid Case Windmills Standard Application Toolkit - 114 Pcs



4750RCHDW02FF4



480 x 290 x 630 mm



1 4750RCHDW02FF4

TAH9070, TAH9072	
TAH3625W-35	
TAH481-300	
TAHBE-9777B	
TAH2820EF2	
TAH1150-1/2H/P	
TAH1177-SCRIBE	
TAH1544	
TAH2509	
TAH2535F2	
MTS-5-25	
TAHPINRELEASER	
TAH2427G-200	
TAH2430G-200	
TAH2628G-160	
TAH8224	
TAH2484-30	
TAH3734BM-3, TAH3734BM-8, TAH3734BM-5	
TAH3755BM-4	
TAHSCB140G	
TAHBE-8030, TAHBE-8020L	
TAHBE-8040S, TAHBE-8050S, TAHBE-8220S	
TAHBE-8155	
TAHBE-8260	
TAHBE-8620S, TAHBE-8610S	
TAHBE-8620, TAHBE-8610	
TAHBE-8630	
TAHBE-8810, TAHBE-8820	
TAHBE-8830	

TAH08-5.5, TAH08-9, TAH08-7, TAH08-8, TAH08-13, TAH08-6, TAH08-11, TAH08-10, TAH08-12		
TAH6961, TAH6962, TAH6960, TAH6962L		
TAH6956-1		
TAH6950		
TAH6966		
TAH6958B-1		
TAH16B-27, TAH16B-30, TAH16B-24, TAH16B-22, TAH16B-32, TAH16B-19, TAH16B-21, TAH16B-17, TAH16B-18, TAH16B-11, TAH16B-15, TAH16B-16, TAH16B-13, TAH16B-10, TAH16B-14, TAH16B-12		
TAH16-H8, TAH16-H6, TAH16-H7, TAH16-H5, TAH16-H17, TAH16-H19, TAH16-H12, TAH16-H14, TAH16-H10		
TAH16-T40, TAH16-T45, TAH16-T50, TAH16-T55, TAH16-T60		
TAH8166		
TAH8150-1/2		
TAH8160, TAH8162		
TAH8158B-1		
TAH111M-32, TAH111M-27, TAH111M-24, TAH111M-21, TAH111M-22, TAH111M-19, TAH111M-9, TAH111M-7, TAH111M-8, TAH111M-18, TAH111M-6, TAH111M-16, TAH111M-17, TAH111M-14, TAH111M-15, TAH111M-12, TAH111M-13, TAH111M-10, TAH111M-11, TAH111M-30		
TAH2101G-160		
TAH2047PR-1-2		
TAH2047-0.8-4		
4750RCHDW02		

Heavy Duty Rigid Case Windmills Heavy Duty Application Toolkit - 36 Pcs



4750RCHDW02FF15

480 x 290 x 630 mm 1 4750RCHDW02FF15

TAH1-100-06-2-4		
TAH1-210-06-2-2		
TAH1-230-06-2-2		

TAH3625PU-50		
TAH489-1100		
TAHBE64520		
TAHPINRELEASER		
TAHSCB140G		
TAH24B-50, TAH24B-46, TAH24B-41, TAH24B-38, TAH24B-36, TAH24B-32, TAH24B-30, TAH24B-27		
TAH8950N/A		
TAH8961		
TAH8953		
TAH7452-2		
TAH7435-100		
TAH111M-50, TAH111M-46, TAH111M-41, TAH111M-36, TAH111M-34		
TAH7444SG-M-46, TAH7444SG-M-41, TAH7444SG-M-36, TAH7444SG-M-55, TAH7444SG-M-50		
4750RCHDW02		
TAH73R-300		

Heavy Duty Rigid Case Aviation Toolkit - 240 Pcs



4750RCHDW01FF1

250 x 345 x 545 mm 1 4750RCHDW01FF1

4750RCHDW01		
FF2B01		
FF2B02		
FF2B03		
FF2B04		
FF2B05		
FF2B06		

Heavy Duty Rigid Case Aviation Toolkit - 159 Pcs



4750RCHDW01FF2

250 x 345 x 545 mm 1 4750RCHDW01FF2

4750RCHDW01		
FF2B07		
FF2B08		
FF2B09		
FF2B10		
FF2B11		

Heavy Duty Rigid Case General Purpose Toolkit - 194 Pcs



4750RCHDW01FF3

250 x 345 x 545 mm 1 4750RCHDW01FF3

4750RCHDW01		
FF2B12		
FF2B13		
FF2B14		
FF2B15		
FF2B16		



Heavy Duty Rigid Case Offshore Oil and Gas Crane Maintenance Application Toolkit - 29 Pcs



4750RCHDW01FF4



250 x 345 x 545 mm

1 4750RCHDW01FF4

TAH8075		
TAH479-32		
TAHBE-9777B		
TAHBE-9787		
TAH2820EF2		
TAHBFRL11		
TAH466-250		
TAHPINRELEASER		
TAH380-10		
TAH2101G-160		
TAH2628G-180		
TAH2855		
TAH8224		
TAHSCB140G		
TAHBE-8258		
TAHBE-8241, TAHBE-8252		
TAHBE-8620L, TAHBE-8620		
4750RCHDW01		
4750-HDLB-TAH		
3875-LY9		
3875-LY5		
3875-RL2		
3875-MHP4		
3875-MHP6		
3875-HB60		
3875-LY60		
3875-LY70		

Heavy Duty Rigid Case Offshore Oil and Gas Training Application Toolkit - 41 Pcs



4750RCHDW01FF9



250 x 345 x 545 mm

1 4750RCHDW01FF9

TAH8073		
TAH84-PODGER		
TAH3640-250-C		
TAH1-143-12-1-2		
TAH479-32		
TAH325		
TAHBE-9777B		
TAH2820EF2		
TAHBFRL11		
TAHPINRELEASER		
TAH380-14		
TAH2101G-140		
TAH2628G-180		
TAH2855		
TAH2958-250		
TAH2484-30		
TAH3734BM-8		
TAHSCB140G		
TAHBE-8257		
TAHBE-8602		
TAH16B-19		
TAH16B-11/16		
TAH16-H8		
TAH8150-1/2		
TAH8158B-1		
TAH1949M-14-17		
4750RCHDW01		
4750-HDLB-TAH		
3875-LY9		
3875-LY5		
3875-RL2		
3875-MHP4		
3875-MHP6		
3875-HB60		
3875-LY60		
3875-LY70		
MTS-5-25		

4750-MTHO-TAH

3875-HB60

TAH2487

TAH466-250

3875-LY60

3875-LY70

TAH73R-300



Aviation Toolkit - 159 Pcs/Rigid Case



4750RCHD01FF1



215 x 410 x 475 mm

1 4750RCHD01FF1

4750RCHD01

FF2A07

FF2A08

FF2A10

FF2A09



Aluminium Tool Box General Purpose Toolkit, 145pcs



4750ALC01FF1



160 x 320 x 450 mm

1 4750ALC01FF1

111M-14, 111M-15, 111M-16, 111M-17, 111M-18, 111M-19, 111M-8, 111M-9, 111M-10, 111M-11, 111M-12, 111M-13



BE-9678	
8072 C IP	
224 D	
2171G-160	
2339-220IP	
2678 G-180	
2470 G-160	
SCB140	
B191.030.075, B191.040.125	
B190.055.125, B190.065.150	
B192.001.100, B192.002.125	
806-1-1	
482F-30	
MTB-5-25	
208	
KB18-01	
808050TS	
59S/0.6-4.5-3P, 59S/1.0-5.5-3P, 59S/1.2-6.5-3P	
59S/PH1-3P, 59S/PH2-3P, 59S/PH3-3P, 59S/PH0-3P	
59S/PH2G-3P	
59S/PZ2-3P, 59S/PZ3-3P, 59S/PZ0-3P, 59S/PZ1-3P	
66IM/T20C-2P, 66IM/T15C-2P, 66IM/T10C-2P, 66IM/T40C-2P, 66IM/T30C-2P, 66IM/T27C-2P, 66IM/T25C-2P	
59S/H1.5-3P, 59S/H3-3P, 59S/H2.5-3P, 59S/H4-3P, 59S/H5-3P, 59S/H2-3P, 59S/H6-3P, 59S/H8-3P	
KM6750-11, KM6750-6, KM6750-7, KM6750-8	
KM6750-10, KM6750-13, K6650-1/4-1P	
KM653-1P	
KSBG18-10DISPEN	
700-1.5-50, 700-1.2-50, 700-1-50, 700-1.8-50	
701-00-50, 701-0-50	
3906-250-24-5P, 3906-250-32-5P	
3735N-4-120	
3734N-2-150, 3734N-4-150, 3734N-6-150	
SBS60-9, SBS60-10, SBS60-11, SBS60-12, SBS60-13, SBS60-4, SBS60-4.5, SBS60-5, SBS60-5.5, SBS60-6, SBS60-7, SBS60-8	
SBS61	
SB6963	
SBS64	
6960-3	
8160-10, 8160-5	
8158-10	
7800SM-20, 7800SM-21, 7800SM-22, 7800SM-23, 7800SM-24, 7800SM-27, 7800SM-12, 7800SM-13, 7800SM-14, 7800SM-15, 7800SM-16, 7800SM-17, 7800SM-18, 7800SM-19, 7800SM-10, 7800SM-11, 7800SM-30, 7800SM-32	
SBS81	
8166	
7772H	

Wheeled Rigid Case General Purpose Toolkit - 32 Pcs



984010320



255 x 390 x 465 mm

1 984010320

4750RCW01

2101D-160IP

224 D

2630D-180

2430 D-160 IP

6M/8C

8071 C IP

483-20

541D-180

2951-180

B191.030.075, B191.040.100

B190.100.200, B190.065.150

B192.001.100, B192.002.125

SC127

2820EF2

BE-9777

MTB-3-16

Rigid Case General Purpose Toolkit - 32 Pcs



983100320



210 x 415 x 460 mm

1 983100320

4750RC02

2101D-160IP

224 D

2430 D-160 IP

8071 C IP

483-20

541D-180

2951-180

B191.030.075, B191.040.100

B190.100.200, B190.065.150

B192.001.100, B192.002.125

SC127

2820EF2

BE-9777

MTB-3-16

2630DC-180IP

6M/8C

Plastic Case General Purpose Toolkit - 32 Pcs



983000320



162 x 380 x 435 mm

1 983000320

4750RC01

2101D-160IP

224 D

2630D-180

2430 D-160 IP

8071 C IP

483-20

541D-180

2951-180

6M/8C

B191.030.075, B191.040.100

B190.100.200, B190.065.125

B192.001.100, B192.002.125

SC127

2820EF2

BE-9777

MTB-3-16



Rigid Case General Purpose Toolkit - 109 Pcs



1995LM-1.5, 1995LM-2, 1995LM-2.5, 1995LM-3, 1995LM-4	
1997M/10T	
2047-0.8-4, 2047-1-5.5	
2421 D-140IP	
2430 GC-200 IP	
2530-40	
2744	
4750RC021	
7372I-2.5-75	
8070 C	
2223 S-150	

150 L Wheeled Rigid Tool Cases with Telescopic Handle and 4 Drawers



4750RCWD4

453 x 340 x 575 mm	1	4750RCWD4
453 x 340 x 575 mm	1	4750RCWD4-OR

153.9 L Wheeled Heavy Duty Rigid Cases



4750RCHDW10

460 x 560 x 860 mm	1	4750RCHDW10

53 L Wheeled Heavy Duty Rigid Cases



4750RCHDW02

290 x 480 x 630 mm	1	4750RCHDW02
290 x 480 x 630 mm	1	4750RCHDW02RED

60x37mm wheels on ball bearings

31 L Wheeled Heavy Duty Rigid Cases



4750RCHDW01

240 x 350 x 545 mm	1	4750RCHDW01
240 x 350 x 545 mm	1	4750RCHDW01RED

60x20 wheels on ball bearing for easy transport even when very loaded

29 L Heavy Duty Rigid Cases



4750RCHD01

215 x 415 x 465 mm	1	4750RCHD01

Indestructible tool case with injected copolymer polypropylene structural resin

2010

109	480 x 180 x 330 mm	1 2010

1952M-6, 1952M-7, 1952M-8, 1952M-9, 1952M-10, 1952M-11, 1952M-12, 1952M-13, 1952M-14	
4020L-M-3, 4020L-M-3.2, 4020L-M-3.5, 4020L-M-4, 4020L-M-4.5, 4020L-M-5.5	
BE-8340, BE-8350, BE-8355	
700-1.5-50, 700-1.2-50, 700-1-50, 700-1.8-50	
3659/8T	
5550-3.2, 5550-4.5	
BE-8220S, BE-8050S, BE-8255S	
5516 I	
5577-145	
5418	
2535L	
3524	
2648	
1150-1/2H/P	
1952Z-1/4, 1952Z-3/8, 1952Z-1/2	
BE-8620S	
BE-7845, BE-7806	
701-0-50, 701-00-50	
8045LVDE	
5574-145	
2-470-16-1-0x 6	
5515GV	
5423	
2665 B-160	
326000300	
328000000	
2656 R	
BE-3529	
BE-6400M-4, BE-6400M-5, BE-6400M-5.5, BE-6400M-7	
BE-8160	
BE-8600, BE-8610	

29 L Heavy Duty Rigid Cases with Tool Pallets



4750RCHD011



215 x 415 x 465 mm

1 4750RCHD011

35 L Rigid Tool Cases



4750RC02



221 x 406 x 485 mm
221 x 406 x 485 mm

1 4750RC02
1 4750RC021

4750RC02: with transparent pouches on one side 4750RC021: With rubber strips on one side

Pivoting Under Lid Tool Pallets with Pouch System



4750RCWD-AC2



30 x 277 x 507 mm

1 4750RCWD-AC2

18.5 L Heavy Duty Rigid Cases



4750RCHD00



205 x 345 x 400 mm

1 4750RCHD00

23-35 L Rigid Tool Cases



4750RC01



165 x 399 x 450 mm

1 4750RC01

Pivoting Under Lid Tool Pallets with Fixed Elastics



4750RCWD-AC3



5 x 277 x 507 mm

1 4750RCWD-AC3

42 L Wheeled Rigid Tool Cases with Telescopic Handle



4750RCW01



257 x 406 x 485 mm
257 x 406 x 485 mm

1 4750RCW01
1 4750RCW011

4750RCW01 with transparent pouches.4750RCW011 with rubber strips on lid and bottom tool pallets

Swivelling Wheel Kit - 4 Pcs



4750RCWD-AC1



100 x 50 x 200 mm

1 4750RCWD-AC1

Fixed Under Lid Tool Pallets with Adjustable Elastics



4750RCWD-AC4



4 x 286 x 490 mm

1 4750RCWD-AC4



Removable Padded Lid Panels for 4750RCHD01



4750RCHD01AC1



35 x 305 x 425 mm



1 4750RCHD01AC1

Internal Bags for 4750RCHDW01 Heavy Duty Rigid Case



4750RCHDW01AC2



120 x 280 x 525 mm



1 4750RCHDW01AC2

Removable Padded Bags for 4750RCHD01 Heavy Duty Rigid Case



4750RCHD01AC2



135 x 360 x 450 mm



1 4750RCHD01AC2

TSA Locks for 4750RCHD Cases



4750RCHD-AC1



20 x 40 x 70 mm



1 4750RCHD-AC1

Removable Lid Panels for 4750RCHDW01 Heavy Duty Case



4750RCHDW01AC1



50 x 204 x 500 mm



1 4750RCHDW01AC1

Foam Inlay Socket Set for 4750RCHD01 Heavy Duty Rigid Case - 64 Pcs



FF2A07



45 x 330 x 430 mm



1 FF2A07

A6710DZ-3/8, A6710DZ-5/16, A6710DZ-7/16, A6710DZ-1/4	
A6800DZ-1/2, A6800DZ-1/4, A6800DZ-11/32, A6800DZ-3/16, A6800DZ-3/8, A6800DZ-5/16, A6800DZ-7/16, A6800DZ-7/32, A6800DZ-9/16, A6800DZ-9/32	
A7400DZ-1/2, A7400DZ-11/16, A7400DZ-13/16, A7400DZ-19/32, A7400DZ-3/4, A7400DZ-3/8, A7400DZ-5/8, A7400DZ-7/16, A7400DZ-7/8, A7400DZ-9/16	
A7402DZ-1/2, A7402DZ-11/16, A7402DZ-13/16, A7402DZ-19/32, A7402DZ-3/4, A7402DZ-3/8, A7402DZ-5/8, A7402DZ-7/16, A7402DZ-7/8, A7402DZ-9/16	
2058-BR	
6950SL	
6954	
6956	
6960, 6962, 6962L	
6966	
6972H	
7407H, 7408H	
7750SL	
7752	
7760, 7761, 7762	
7764	
7765	
7766	
8164-1/2	

Foam Inlay Wrench and File Set for 4750RCHD01 Heavy Duty Rigid Case - 24 Pcs



FF2A08



45 x 335 x 435 mm



1 FF2A08

1-100-04-2-2	
1-230-04-2-2	
111Z-1, 111Z-1/2, 111Z-1/4, 111Z-11/16, 111Z-3/4, 111Z-3/8, 111Z-5/16, 111Z-5/8, 111Z-7/16, 111Z-9/16, 111Z-7/8	
1177-SCRIBE	
1320RZ-1/2-9/16, 1320RZ-1/4-5/16, 1320RZ-3/8-7/16, 1320RZ-5/16-11/32	
1931Z-1/4, 1931Z-3/16, 1931Z-7/32	
1950MZ-3/8	
208	
9031 C	

Foam Inlay Screwdriver and Wrench Set for 4750RCHD01 Heavy Duty Rigid Case - 56 Pcs



FF2A09



45 x 335 x 440 mm 1 FF2A09

BE-8040, BE-8210		
BE-8260		
BE-8600, BE-8610, BE-8620		
BE-9780		
MTB-3-16-E		
2047-1-5.5		
2047PR-1-2		
59/S28-4		
2509		
2535F2		
5515T-52		
808050		
1179-FLX-2, BFLA01		
BE-8150		

Foam Inlay Toolset for Heavy Duty Rigid Cases - 15 Pcs



FF2A10



49 x 330 x 435 mm 1 FF2A10

2101GC-160IP	
2427 GC-200IP	
2628 GC-160IP	
2632	
2650	
2855	
2979 D-180	
3625N-32	
3734-2, 3734-3, 3734-4, 3734-5	
3735-4-120	
481-300	
8224CIP	

Foam Inlay Socket Set for 4750RCHD01 Heavy Duty Rigid Case - 61 Pcs



FF2B01



40 x 270 x 505 mm 1 FF2B01

A6700DZ-1/2, A6700DZ-1/4, A6700DZ-11/32, A6700DZ-3/16, A6700DZ-3/8, A6700DZ-5/16, A6700DZ-7/16, A6700DZ-7/32, A6700DZ-9/16, A6700DZ-9/32	
A6800DZ-1/2, A6800DZ-1/4, A6800DZ-11/32, A6800DZ-3/16, A6800DZ-3/8, A6800DZ-5/16, A6800DZ-7/16, A6800DZ-7/32, A6800DZ-9/16, A6800DZ-9/32	
A7400DZ-1/2, A7400DZ-1/4, A7400DZ-11/16, A7400DZ-17/32, A7400DZ-19/32, A7400DZ-3/4, A7400DZ-3/8, A7400DZ-5/16, A7400DZ-5/8, A7400DZ-7/16, A7400DZ-9/16	
A7402DZ-1/2, A7402DZ-1/4, A7402DZ-11/16, A7402DZ-19/32, A7402DZ-3/4, A7402DZ-3/8, A7402DZ-5/16, A7402DZ-5/8, A7402DZ-7/16, A7402DZ-9/16	
6950SL	
6954	
6956	
6958	
6960, 6961, 6962L	
6966	
6972H	
7407H	
7750SL	
7752	
7760, 7761, 7762	
7764	
7765	
7766	
8164-1/2	
U-S6106KA	

Foam Inlay Wrench and Socket Set for 4750RCHD01 Heavy Duty Rigid Case - 69 Pcs



FF2B02



39 x 270 x 505 mm 1 FF2B02

A6700DM-5.5, A6700DM-6, A6700DM-11, A6700DM-12, A6700DM-13, A6700DM-14, A6700DM-7, A6700DM-8, A6700DM-9, A6700DM-10	
A6800DM-6, A6800DM-7, A6800DM-8, A6800DM-9, A6800DM-4, A6800DM-5, A6800DM-5.5, A6800DM-14, A6800DM-10, A6800DM-11, A6800DM-12, A6800DM-13	
A7400DM-10, A7400DM-14, A7400DM-15, A7400DM-16, A7400DM-11, A7400DM-12, A7400DM-17, A7400DM-18, A7400DM-19, A7400DM-13	
A7402DM-19, A7402DM-15, A7402DM-16, A7402DM-17, A7402DM-18, A7402DM-11, A7402DM-12, A7402DM-13, A7402DM-14, A7402DM-10	
BE-9770	
111M-24, 111M-6, 111M-7, 111M-12, 111M-13, 111M-14, 111M-15, 111M-8, 111M-9, 111M-10, 111M-11, 111M-22, 111M-16, 111M-17, 111M-18, 111M-19	
4020L-M-5, 4020L-M-5.5	

Foam Inlay Wrench and Socket Set for 4750RCHD01 Heavy Duty Rigid Case - 44 Pcs



FF2B03



35 x 270 x 505 mm 1 FF2B03

A6710DM-7	
A6710DZ-1/2, A6710DZ-1/4, A6710DZ-11/32, A6710DZ-3/16, A6710DZ-3/8, A6710DZ-5/16, A6710DZ-7/16, A6710DZ-7/32, A6710DZ-9/16, A6710DZ-9/32	
BE-9780	
111Z-1, 111Z-1/2, 111Z-1/4, 111Z-11/16, 111Z-3/4, 111Z-3/8, 111Z-5/16, 111Z-5/8, 111Z-7/16, 111Z-7/8, 111Z-9/16, 111Z-13/16	
1320RZ-1/2-9/16, 1320RZ-1/4-5/16, 1320RZ-3/8-7/16, 1320RZ-5/16-11/32	
1931Z-1/4, 1931Z-3/16, 1931Z-7/32	
1950MZ-3/8	
2058-BR	



Foam Inlay Socket Set for 4750RCHDW01 Heavy Duty Rigid Case - 45 Pcs



FF2B04

42 x 270 x 505 mm	1 FF2B04

BE-8020L, BE-8040		
BE-8080-10		
BE-8150, BE-8255		
BE-8610, BE-8620		
1544		
2509		
59/S28-4		
2535F2		
5516		
700-1.5-50, 700-1-50		
701-0-50, 701-00-50		
808050		
9070C		

Foam Inlay Pliers Set for 4750RCHDW01 Heavy Duty Rigid Case - 15 Pcs



FF2B05

35 x 270 x 510 mm	1 FF2B05

1150-1/2H/P	
MTB-3-16-M-E	
2101GC-125IP, 2101GC-160IP	
2427 GC-200IP	
2628 GC-160IP	
2650	
2820EF2	
2855	
4130	
4830	
5515T-52	
8224CIP	
BFLA01, 1179-FLX-2	

Foam Inlay Hammer and Punch Set for 4750RCHDW01 Heavy Duty Rigid Case - 6 Pcs



FF2B06

35 x 122 x 355 mm	1 FF2B06

3625N-32	
3734-5, 3734-8, 3734-3	
3735-5-120	
481-300	

Foam Inlay Wrench and Socket Set for 4750RCHDW01 Heavy Duty Rigid Case - 62 Pcs



FF2B07

35 x 270 x 505 mm	1 FF2B07

A6700DZ-1/2, A6700DZ-1/4, A6700DZ-11/32, A6700DZ-3/16, A6700DZ-3/8, A6700DZ-5/16, A6700DZ-7/16, A6700DZ-7/32, A6700DZ-9/16, A6700DZ-9/32	
A6710DZ-3/8, A6710DZ-5/16, A6710DZ-7/16	
A6800DZ-1/2, A6800DZ-1/4, A6800DZ-11/32, A6800DZ-3/16, A6800DZ-3/8, A6800DZ-5/16, A6800DZ-7/16, A6800DZ-7/32, A6800DZ-9/16, A6800DZ-9/32	
A7400DZ-1/2, A7400DZ-11/16, A7400DZ-13/16, A7400DZ-19/32, A7400DZ-3/4, A7400DZ-3/8, A7400DZ-5/8, A7400DZ-7/16, A7400DZ-7/8, A7400DZ-9/16	
A7402DZ-1/2, A7402DZ-11/16, A7402DZ-13/16, A7402DZ-19/32, A7402DZ-3/4, A7402DZ-3/8, A7402DZ-5/8, A7402DZ-7/16, A7402DZ-7/8, A7402DZ-9/16	
6950SL	
6954	
6956	
6960, 6962, 6962L	
6966	
6972H	

7407H, 7408H	
7750SL	
7752	
7760, 7761, 7762	
7764	
7765	
7766	
8164-1/2	

Foam Inlay Wrench Set for 4750RCHDW01 Heavy Duty Rigid Case - 25 Pcs



FF2B08

44 x 270 x 505 mm	1 FF2B08

1-100-04-2-2	
1-230-04-2-2	
111Z-1, 111Z-1/2, 111Z-1/4, 111Z-11/16, 111Z-3/4, 111Z-3/8, 111Z-5/16, 111Z-5/8, 111Z-7/16, 111Z-7/8, 111Z-9/16	
1177-SCRIBE	
1320RZ-1/2-9/16, 1320RZ-1/4-5/16, 1320RZ-3/8-7/16, 1320RZ-5/16-11/32	
1931Z-1/4, 1931Z-3/16, 1931Z-7/32	
1950MZ-3/8	
2058-BR	
208	
9031 C	

Foam Inlay Screwdriver Set for 4750RCHDW01 Heavy Duty Rigid Case - 56 Pcs



FF2B09

47 x 270 x 505 mm	1 FF2B09

BE-8040, BE-8210		
BE-8150		
BE-8260		
BE-8600, BE-8610, BE-8620		
BE-9780		

MTB-3-16-E	
2047-1-5.5	
2047PR-1-2	
2509	
2535F2	
5515T-52	
59/S28-4	
BFLA01, 1179-FLX-2	
808050	

Foam Inlay Aviation Pliers Set for 4750RCHDW01 Heavy Duty Rigid Case - 9 Pcs



FF2B10
 37 x 270 x 505 mm 1 FF2B10

2101GC-160IP	
2427 GC-200IP	
2430 GC-200 IP	
2628 GC-160IP	
2650	
2744	
2855	
2979 D-180	
8224CIP	

Foam Inlay Striking Toolset for 4750RCHDW01 Heavy Duty Rigid Case - 7 Pcs



FF2B11
 39 x 122 x 355 mm 1 FF2B11

2632	
3625N-32	
3734-2, 3734-3, 3734-4, 3734-5	
481-300	

Foam Inlay Socket Set for 4750RCHDW01 Heavy Duty Rigid Case - 92 Pcs



FF2B12
 44 x 270 x 505 mm 1 FF2B12

A6800DM-6, A6800DM-7, A6800DM-8, A6800DM-9, A6800DM-5.5, A6800DM-10, A6800DM-11, A6800DM-12, A6800DM-13

A7402DM-19, A7402DM-15, A7402DM-16, A7402DM-17, A7402DM-18, A7402DM-11, A7402DM-12, A7402DM-13, A7402DM-14, A7402DM-10

6700SM-5.5, 6700SM-6, 6700SM-11, 6700SM-12, 6700SM-13, 6700SM-7, 6700SM-8, 6700SM-9, 6700SM-10

6709M-3, 6709M-4, 6709M-5, 6709M-6, 6709M-8

6709PH-1, 6709PH-2, 6709PH-3

6709TORX-T20, 6709TORX-T25, 6709TORX-T27, 6709TORX-T30, 6709TORX-T8, 6709TORX-T9, 6709TORX-T10, 6709TORX-T15, 6709TORX-T40

6954

6956

6958

6960, 6961, 6962, 6962L

6966

6972H

7400SM-6, 7400SM-11, 7400SM-12, 7400SM-13, 7400SM-14, 7400SM-7, 7400SM-8, 7400SM-9, 7400SM-10, 7400SM-19, 7400SM-22, 7400SM-15, 7400SM-16, 7400SM-17, 7400SM-18

7407H

7409M-8, 7409M-10, 7409M-4, 7409M-5, 7409M-6, 7409M-7, 7409M-3

7409TORX-T25, 7409TORX-T27, 7409TORX-T30, 7409TORX-T40, 7409TORX-T45, 7409TORX-T50

7750SL

7761, 7762, 7760

7764

7765

7766

8164-1/2

6950SL

Foam Inlay Wrench Set for 4750RCHDW01 Heavy Duty Rigid Case - 39 Pcs



FF2B13
 50 x 270 x 505 mm 1 FF2B13

BE-9770

111M-12, 111M-13, 111M-14, 111M-15, 111M-8, 111M-9, 111M-10, 111M-11, 111M-6, 111M-7, 111M-21, 111M-22, 111M-16, 111M-17, 111M-18, 111M-19

6M-6-7, 6M-8-9, 6M-10-11, 6M-12-13, 6M-14-15, 6M-16-17, 6M-18-19, 6M-20-22

9070C

1177-SCRIBE

2535F2

BFLA01

7758

7754

Foam Inlay Screwdriver Set for 4750RCHDW01 Heavy Duty Rigid Case - 48 Pcs



FF2B14
 35 x 270 x 505 mm 1 FF2B14

BE-8020L, BE-8030

BE-8155

BE-8260

BE-8350

BE-8601, BE-8602

BE-8610, BE-8620

BE-8630

1544

2047-0.8-4

2047PR-1-2

2058-BR

2509

808050P

808050S

59S/31-1



Foam Inlay General Purpose Pliers Set for 4750RCHDW01 Heavy Duty Rigid Case - 9 Pcs



FF2B15



35 x 270 x 505 mm

1 FF2B15

1150-1/2H/P	
2101GC-160IP	
2427 GC-200IP	
2430 GC-200 IP	
2628 GC-160IP	
2820EF2	
5515T-52	
8224CIP	
MTB-3-16-M-E	

Foam Inlay Striking Set for 4750RCHDW01 Heavy Duty Rigid Case - 6 Pcs



FF2B16



34 x 122 x 355 mm

1 FF2B16

3625W-35	
3734-3, 3734-5, 3734-8	
3735-4-120	
481-300	

CABINETS, PANELS & WORKBENCHES

1800 mm Tool Cabinets with Shutter General Purpose Toolkit - 110 Pcs



1495CS18TS1



900 x 170 x 1800 mm

1 1495CS18TS1

1495CS18	
981001100	
1495CS-AC1	
1495TP-AC10	

1500 mm Tool Cabinets with Shutter General Purpose Toolkit - 110 Pcs



1495CS15TS1



900 x 170 x 1500 mm

1 1495CS15TS1

1495CS15	
981001100	
1495CS-AC1	
1495TP-AC10	

Tool Cabinets with 2 Doors General Purpose Toolkit - 110 Pcs



1495CD60TS1



900 x 250 x 602 mm

1 1495CD60TS1

1495CD60	
981001100	
1495CD-AC1	
1495TP-AC10	

Foam Inlay Metric Toolset for our metallic cases 1483K & 1483KHD Series - 12 Pcs



FF3A11



39 x 205 x 445 mm

1 FF3A11

1150-1/2H/P	
MTB-3-16	
1177-SCRIBE	
2101GC-160IP	
2427 GC-200IP	
2430 GC-200 IP	
2628 GC-160IP	
3734-3, 3734-5, 3734-8	
3735-4-120	
8224CIP	

Foam Inlay Metric Toolset for our metallic cases 1483K & 1483KHD Series - 28 Pcs



FF3A12



45 x 205 x 450 mm

1 FF3A12

111M-6, 111M-21, 111M-19, 111M-18,
111M-22, 111M-13, 111M-12, 111M-11,
111M-10, 111M-17, 111M-16, 111M-15,
111M-14, 111M-9, 111M-8, 111M-7

2820EF2

5515T-52

6M-10-11, 6M-6-7, 6M-12-13, 6M-8-9,
6M-14-15, 6M-16-17, 6M-18-19, 6M-
20-22

BFLA01

9070C

Foam Inlay Metric Toolset for our metallic cases 1483K & 1483KHD Series - 49 Pcs



FF3A13



68 x 245 x 525 mm

1 FF3A13

111M-27, 111M-32, 111M-24, 111M-30

6M-24-27, 6M-30-32

7800SM-19, 7800SM-18, 7800SM-17,
7800SM-16, 7800SM-22, 7800SM-21,
7800SM-11, 7800SM-10, 7800SM-15,
7800SM-14, 7800SM-13, 7800SM-12,
7800SM-27, 7800SM-32, 7800SM-30,
7800SM-24

7807H

7809M-10, 7809M-12, 7809M-14,
7809M-19, 7809M-17, 7809M-5, 7809M-
8, 7809M-6, 7809M-7

7809TORX-T50, 7809TORX-T45,
7809TORX-T60, 7809TORX-T55,
7809TORX-T25, 7809TORX-T20,
7809TORX-T40, 7809TORX-T30,
7809TORX-T27

8150SL

8164-1/2

8154-11

8160-5, 8160-10

8171

8166

8172

Foam Inlay Imperial Toolset for our metallic cases 1483K & 1483KHD Series - 77 Pcs



FF3A14



65 x 247 x 510 mm

1 FF3A14

A6700DZ-1/2, A6700DZ-1/4,
A6700DZ-3/8, A6700DZ-5/16,
A6700DZ-7/16, A6700DZ-7/32,
A6700DZ-9/16, A6700DZ-9/32,
A6700DZ-11/32

A6800DZ-1/4, A6800DZ-5/16,
A6800DZ-7/32, A6800DZ-9/32

A7400DM-10, A7400DM-13

A7400DZ-1/2, A7400DZ-11/16,
A7400DZ-13/16, A7400DZ-3/4,
A7400DZ-5/8, A7400DZ-7/8,
A7400DZ-9/16

A7402DZ-1/2, A7402DZ-3/8,
A7402DZ-7/16, A7402DZ-9/16

111Z-1, 111Z-1.1/8

59/S28-4

6Z-1.1/16-1.1/4, 6Z-1.1-1/8

6Z/8C

6950SL

6958

6960, 6961

6966

6972H

7407H, 7408H

7750SL

7752

7760, 7761

7764

7765

7766

7800DZ-1, 7800DZ-15/16

8164-1/2

1952Z-15/16

8171

Foam Inlay Imperial Toolset for our metallic cases 1483K & 1483KHD Series - 14 Pcs



FF3A15



40 x 210 x 445 mm

1 FF3A15

BE-3529

BE-8020L

BE-8155

BE-8260

BE-8601, BE-8602

BE-8611, BE-8621

1177-SCRIBE

2047-1.2-8

2047PR-1-2

5515T-52

1179-FLX-2

9715-14-250

Foam Inlay Imperial Toolset for our metallic cases 1483K & 1483KHD Series - 12 Pcs



FF3A16



42 x 210 x 445 mm

1 FF3A16

MTB-3-16-E

2101GC-160IP

2421GC-180IP

3658A-3, 3658A-5, 3658A-8

3735-5-120

3740-150

8224CIP

2855 D

0454800500, BFLB01



Foam Inlay Imperial Toolset for our metallic cases 1483K & 1483KHD Series - 30 Pcs



FF3A17

48 x 205 x 450 mm	1	FF3A17

BE-9780	
KE18-01	
1300Z-1/4-5/16, 1300Z-3/8-7/16	
1320RZ-1/4-5/16, 1320RZ-3/8-7/16	
1931Z-1/4, 1931Z-7/32	
1952Z-1/2, 1952Z-11/16, 1952Z-11/32, 1952Z-13/16, 1952Z-3/4, 1952Z-5/8, 1952Z-7/8, 1952Z-9/16	
2628 GC-180IP	
7758	
U-DS2018A, U-XID1415A, U-XID1618A	

General Purpose Tool Kit - 109 pcs



981001100

109	27 kg	1 981001100

1546	
2521GC-160	
2630GC-180IP, 2630GC-200IP	
6M-12-13, 6M-14-15, 6M-10-11, 6M-6-7, 6M-8-9, 6M-20-22, 6M-21-23, 6M-24-27, 6M-25-28	
8150RN-1/2	
8154-1/2, 2421GC-160, 8160-1/2, 8162-1/2, 8166-1/2	
9048-400	
9-469-00-0-0	
1998M/10T	
3733-4	

3734-4	
814-100	
815-2-25, 815-1-100, 815-2-125	
9710-8-150, 9710-6.5-125	
2101GC-200HL	
2800-180	
SC127	
1-100-08-2-2, 1-100-10-2-2	
1150-1/2H/P	
2101D-140IP	
2535F1	
3906-300-24-2P	
2951-250	
2M-6-7, 2M-8-9, 2M-10-11, 2M-12-13, 2M-14-15, 2M-16-17, 2M-18-19, 2M-20-22, 2M-21-23, 2M-24-27	
3645-150-C	
4544-10	
813-3-75, 813-4-100, 813-5.5-125	
1-230-08-1-2	
2430 GC-160 IP	
3735-4-120	
2900-180	
3625W-35	
479-16	
869102500	
1-170-08-2-2	
1-210-08-2-2	
8072 C, 8071 C	
225-PLUS	
2427 GC-200IP	
3640-150-C	
7800DM-18, 7800DM-17, 7800DM-16, 7800DM-11, 7800DM-10, 7800DM-15, 7800DM-14, 7800DM-13, 7800DM-12, 7800DM-19, 7800DM-23, 7800DM-22, 7800DM-21, 7800DM-20, 7800DM-24, 7800DM-26, 7800DM-28, 7800DM-30, 7800DM-32, 7800DM-27	
813VDE-3-100	
6224	

Wall or Bench Mount Cabinet with Shutter and Hooks



1495CS18HK

900 x 170 x 1800 mm	1	1495CS18HK
900 x 170 x 1800 mm	1	1495CS18BLHK

Wall or Bench Mount Cabinet with Shutter



1495CS1

900 x 170 x 1500 mm	1	1495CS15
900 x 170 x 1800 mm	1	1495CS18
900 x 170 x 1500 mm	1	1495CS15BL
900 x 170 x 1800 mm	1	1495CS18BL

2-Door Wall Mount Tool Cabinets



1495CD60

900 x 250 x 602 mm	1	1495CD60

2-Door Wheeled Tool Cabinets



1495CD60W



1605 x 450 x 625 mm

1 1495CD60W

Tool Panel Auto Repair Tool Kit - 62 pcs



1495TP-AUTO-M1



900 x 25 x 500 mm

1 1495TP-AUTO-M1

1495TP09	
BP910	
BP909TH	
BE-9678	
BE-9675	

29M-30		
2997-250		
1995LM-9, 1995LM-8, 1995LM-6		
3750		
1177-SCRIBE		
K7801M-9, K7801M-10, K7801M-11, K7801M-12, K7801M-13, K7801M-14, K7801M-15, K7801M-16, K7801M-17, K7801M-18, K7801M-19, K7801M-21, K7801M-22, K7801M-23, K7801M-24, K7801M-30, K7801M-32		
K7806M-15, K7806M-21, K7806M-24, K7806M-27		
K8901M-32, K8901M-34, K8901M-36		
K8964D		
K8167S		
K8160D-3		
2800-150		
2900-150		
3734S/6		
BE-8258TB		
1495TP-ACHL40x 9, 1495TP-ACHL65x 9, 1495TP-ACHL20x 33		

Tool Panel Auto Repair Tool Kit - 53 pcs



1495TP-AUTO-M2



900 x 25 x 500 mm

1 1495TP-AUTO-M2

1495TP09	
BE301	
K7801TORX-E10, K7801TORX-E12, K7801TORX-E14, K7801TORX-E16, K7801TORX-E18, K7801TORX-E20	
K8160D-2	
BE301CM	
BWHEPSSH8	
BE51038, BE510310, BE510312	
BP822	
BP825	
1495TP-ACHL40x 25, 1495TP-ACHL65x 4, 1495TP-ACHL20x 29	
1495TP-AC4	

Tool Panel Auto Repair Tool Kit - 34 pcs



1495TP-AUTO-M3



900 x 25 x 500 mm

1 1495TP-AUTO-M3

1495TP09	
BE1GP5-T	
6968	
BE1SP1F	
BE6OF108	
BE6307414F	
BE6OFW	
BE1FFWF	
BE63064514F1	
BE6810Z, BE6810	
BE6FCP	
52	
1546	
2421GC-160, 6962-W, 8166-1/2	
5515M	
BE1P	
7455-60	
BE1FLD2, BE1FLD1, BE1FLD3	
BE65F65120	
7764	
8164-1/2	
BE6302712F	
6954	
BE6701VAG	
BE62110	
BE1310P427	
7406ZZ-21, 7406ZZ-16	
BE1SP14L	
BE1GP5	
1495TP-AC3	
1495TP-ACHL20x 38, 1495TP-ACHL40, 1495TP-ACHL65	



Tool Panel Auto Repair Tool Kit - 23 pcs



1495TP-AUTO-M4



900 x 25 x 500 mm 1 1495TP-AUTO-M4

1495TP09	
BS618	
4545-N1, 4545-N11	
4545-1, 4545-2	
MTB-3-16	
361-14	
8900SM-41	
BS52	
8169-1/2, 8165-1/2	
747-22, 747-21, 747-19, 747-17, 747-15, 747-14, 747-13, 747-12	
BS40VAG	
BS56	
BS100PSA1	
BS45BMW	
1495TP-ACHL40x 10, 1495TP-ACHL65x 5, 1495TP-ACHL20x 20	

1495TP09	
319	
484-1000	
SB3654BM-20	
3625S-44	
B192.004.200	
BE-8258TB	
2484/S4	
B194.030.150, B194.025.125, B194.020.100, B194.010.075	
600.005.012	
BBS165	
K7801TORX-E10, K7801TORX-E12, K7801TORX-E14, K7801TORX-E16, K7801TORX-E18, K7801TORX-E20, K7801TORX-E24	
BBR203P920, BBR203P925, BBR203P930, BBR203P940, BBR203P945, BBR203P950, BBR203P955, BBR203P960	
1495TP-ACHL40x 13, 1495TP-ACHL20x 38	
8226	

Tool Panel Auto Repair Tool Kit - 42 pcs

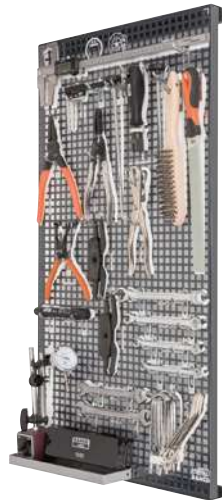

1495TP-AUTO-M6



900 x 25 x 500 mm 1 1495TP-AUTO-M6

1495TP09	
FM10	
782-U	
BBR405	
BBR400	
BBR210P3	
BBR6131	
BBR204	
BBR150I	

Tool Panel Auto Repair Tool Kit - 32 pcs



1495TP-AUTO-M5



900 x 25 x 500 mm 1 1495TP-AUTO-M5

BBR501011, BBR50121314	
2900-215	
7823	
BBR100	
1154	
6M-16-17, 6M-14-15	
1949M-17-19, 1949M-12-13, 1949M-10-11, 1949M-8-9	
1495TP-ACHL40x 2, 1495TP-ACHL20x 29	
1495TP-AC3	

Heavy Duty Tool Hanger Panels with Reinforced Frame

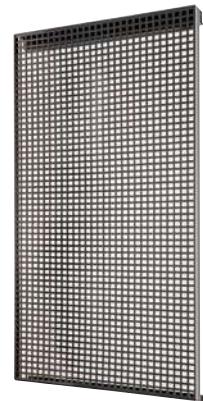

1495TP09

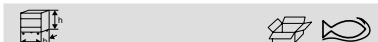

900 x 25 x 500 mm 1 1495TP09

Heavy Duty Tool Panels with Reinforced Frame

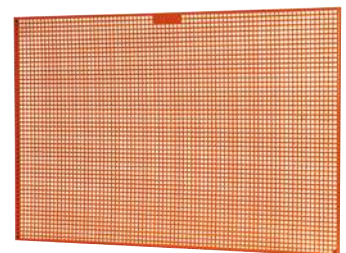

1495TP



500 x 23 x 600 mm	1 1495TP06
800 x 25 x 1200 mm	1 1495TP12
800 x 23 x 1500 mm	1 1495TP15
800 x 23 x 1800 mm	1 1495TP18
500 x 25 x 600 mm	1 1495TP06GR
800 x 25 x 1200 mm	1 1495TP12GR
800 x 25 x 1800 mm	1 1495TP18GR

Hanging Rail for 1495TP09 Panels



1495TP09-RAIL



40 x 57 x 440 mm



1 1495TP09-RAIL

Hook Kit for 1495 Cabinet and Panel - 35 Pcs

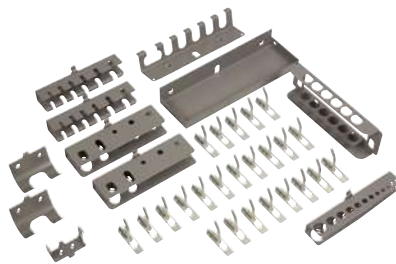

1495CS-AC1



2.11 kg



1 1495CS-AC1

Hammer 1-Slot Holders for Tool Panels



1495TP-AC12



0.07 kg



1 1495TP-AC12

Tool Panel Adaptors for Wooden and MDF Workbench Tops



1495TP-AC1



9.5 kg



1 1495TP-AC1

Combination Wrenches 12-Slot Holders for Tool Panels



1495TP-AC10



0.43 kg



1 1495TP-AC10

T-Handle 1-Slot Holders for Tool Panels



1495TP-AC13



0.04 kg



1 1495TP-AC13

Hook Kit for 1495 Cabinet and Panel - 24 Pcs

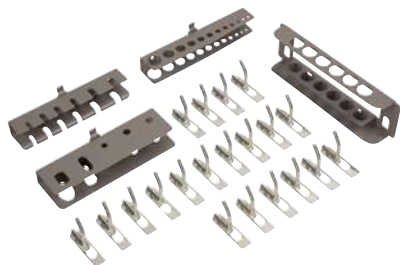

1495CD-AC1



1.22 kg



1 1495CD-AC1

Pin Punch 6-Slot Holders for Tool Panels

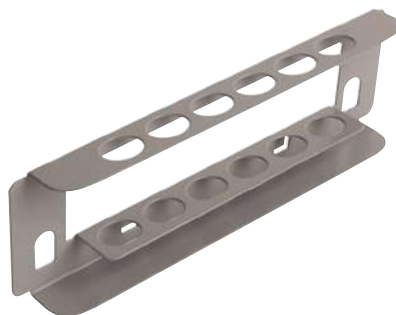

1495TP-AC11



0.16 kg



1 1495TP-AC11

Trays for Tool Panels



1495TP-AC2



0.44 kg



1 1495TP-AC2



Socket Hook and Tray Kit for Tool Panels



1495TP-AC3



0.45 kg



1 1495TP-AC3

Plastic Trays for Tool Panels



1495TP-AC4



0.125 kg



1 1495TP-AC4

Screwdriver 6-Slot Hooks for Tool Panels

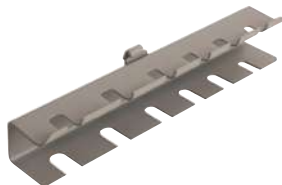

1495TP-AC5



0.14 kg



1 1495TP-AC5

Pliers 5-Slot Hooks for Tool Panels



1495TP-AC6



0.17 kg



1 1495TP-AC6

Grip 1-Slot Hooks for Tool Panels



1495TP-AC7



0.79 kg



1 1495TP-AC7

Hexagon 12-Slot L-Key Hooks for Tool Panels

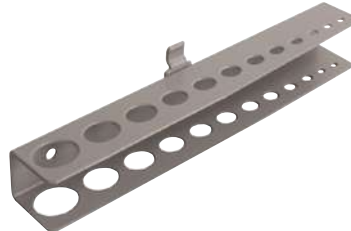

1495TP-AC8



0.12 kg



1 1495TP-AC8

Double Socket Wrench 12-Slot Hooks for Tool Panel



1495TP-AC9



0.43 kg



1 1495TP-AC9

L/U Shaped Hooks Set for Tool Panels - 5 Pcs



1495TP-ACH



0.116 kg



1 1495TP-ACHL20

0.125 kg

1 1495TP-ACHL40

0.144 kg

1 1495TP-ACHL65

0.17 kg

1 1495TP-ACHL90

0.102 kg

1 1495TP-ACHU20

0.125 kg

1 1495TP-ACHU40

0.146 kg

1 1495TP-ACHU65

0.162 kg

1 1495TP-ACHU90

Heavy Duty Steel Top Workbenches with Side Drawer Tower and 2-Leg 1800 mm x 750 mm x 1030 mm



1495KCWB18TS



1030 x 750 x 1800 mm



1 1495K6CWB18TS

1030 x 750 x 1800 mm

1 1495K7CWB18TS

1030 x 750 x 1800 mm

1 1495K8CWB18TS

1030 x 750 x 1800 mm

1 1495K6CBKWB18TS

1030 x 750 x 1800 mm

1 1495K7CBKWB18TS

1030 x 750 x 1800 mm

1 1495K8CBKWB18TS

1030 x 750 x 1800 mm

1 1495K6CBLWB18TS

1030 x 750 x 1800 mm

1 1495K7CBLWB18TS

1030 x 750 x 1800 mm

1 1495K8CBLWB18TS

1030 x 750 x 1800 mm

1 1495K6CRDWB18TS

1030 x 750 x 1800 mm

1 1495K7CRDWB18TS

1030 x 750 x 1800 mm

1 1495K8CRDWB18TS

Heavy Duty Steel Top Workbenches with Side Drawer Tower and 2-Leg 1500 mm x 750 mm x 1030 mm



1495KCWB15TS



1030 x 750 x 1500 mm	1	1495K6CWB15TS
1030 x 750 x 1500 mm	1	1495K7CWB15TS
1030 x 750 x 1500 mm	1	1495K8CWB15TS
1030 x 750 x 1500 mm	1	1495K6CBKWB15TS
1030 x 750 x 1500 mm	1	1495K7CBKWB15TS
1030 x 750 x 1500 mm	1	1495K8CBKWB15TS
1030 x 750 x 1500 mm	1	1495K6CBLWB15TS
1030 x 750 x 1500 mm	1	1495K7CBLWB15TS
1030 x 750 x 1500 mm	1	1495K8CBLWB15TS
1030 x 750 x 1500 mm	1	1495K6CRDWB15TS
1030 x 750 x 1500 mm	1	1495K7CRDWB15TS
1030 x 750 x 1500 mm	1	1495K8CRDWB15TS

Steel Top Kit for Convert 1475K Tool Trolley to Workbench



1495KW-TS



1030 x 750 x 1500 mm	1	1495KWB15TS
1030 x 750 x 1800 mm	1	1495KWB18TS

Heavy Duty Wooden Top Workbenches with Side Drawer Tower and 2-Leg 1800 mm x 750 mm x 1030 mm



1495KCWB18TW



1030 x 750 x 1800 mm	1	1495K6CWB18TW
1030 x 750 x 1800 mm	1	1495K7CWB18TW
1030 x 750 x 1800 mm	1	1495K8CWB18TW
1030 x 750 x 1800 mm	1	1495K6CBKWB18TW
1030 x 750 x 1800 mm	1	1495K7CBKWB18TW
1030 x 750 x 1800 mm	1	1495K8CBKWB18TW
1030 x 750 x 1800 mm	1	1495K6CBLWB18TW
1030 x 750 x 1800 mm	1	1495K7CBLWB18TW
1030 x 750 x 1800 mm	1	1495K8CBLWB18TW
1030 x 750 x 1800 mm	1	1495K6CRDWB18TW
1030 x 750 x 1800 mm	1	1495K7CRDWB18TW
1030 x 750 x 1800 mm	1	1495K8CRDWB18TW

Heavy Duty Wooden Top Workbenches with Side Drawer Tower and 2-Leg 1500 mm x 750 mm x 1030 mm



1495KCWB15TW



1030 x 750 x 1500 mm	1	1495K6CWB15TW
1030 x 750 x 1500 mm	1	1495K7CWB15TW
1030 x 750 x 1500 mm	1	1495K8CWB15TW
1030 x 750 x 1500 mm	1	1495K6CBKWB15TW
1030 x 750 x 1500 mm	1	1495K7CBKWB15TW
1030 x 750 x 1500 mm	1	1495K8CBKWB15TW
1030 x 750 x 1500 mm	1	1495K6CBLWB15TW
1030 x 750 x 1500 mm	1	1495K7CBLWB15TW
1030 x 750 x 1500 mm	1	1495K8CBLWB15TW
1030 x 750 x 1500 mm	1	1495K6CRDWB15TW
1030 x 750 x 1500 mm	1	1495K7CRDWB15TW
1030 x 750 x 1500 mm	1	1495K8CRDWB15TW

Heavy Duty Wooden Countertop Kit for Convert 1475k Series Trolley to Workbench



1495KWB-TW



1030 x 750 x 1500 mm	1	1495KWB15TW
1030 x 750 x 1800 mm	1	1495KWB18TW

Heavy Duty Steel Top Workbenches & Bottom Tray with 4 Legs - 1800 mm



1495WB18TSBT



1030 x 750 x 1800 mm	1	1495WB18TSBT
1030 x 750 x 1800 mm	1	1495WB18TSBLBT

Heavy Duty Steel Top Workbenches & Bottom Tray with 4 Legs - 1500 mm



1495WB15TSBT



1030 x 750 x 1500 mm	1	1495WB15TSBT
----------------------	---	--------------



Heavy Duty Steel Top Workbenches with 4-Leg



1495WB-TS



1030 x 750 x 1500 mm	1	1495WB15TS
1030 x 750 x 1800 mm	1	1495WB18TS
1030 x 750 x 1800 mm	1	1495WB18TSBK
1030 x 750 x 1500 mm	1	1495WB15TSBL
1030 x 750 x 1800 mm	1	1495WB18TSBL
1030 x 750 x 1500 mm	1	1495WB15TSRED
1030 x 750 x 1800 mm	1	1495WB18TSRED

Heavy Duty Chestnut Top Workbenches with 4-Leg



1495WB-TW



1030 x 750 x 1500 mm	1	1495WB15TW
1030 x 750 x 1800 mm	1	1495WB18TW
1030 x 750 x 1500 mm	1	1495WB15TWGR
1030 x 750 x 1800 mm	1	1495WB18TWGR

Steel Bottom Trays for 1495WB Workbenches



1495WB1-AC



30 x 504 x 1500 mm	1	1495WB15-AC1
30 x 504 x 1800 mm	1	1495WB18-AC1

Drawers with Trays or Dividers for 1495WB Workbenches



1495WB-AC



105 x 500 x 500 mm	1	1495WB-AC1
--------------------	---	------------

MDF and Galvanized Top Portable Workbenches



1495FWBTD



840 x 510 x 970 mm	1	1495FWB097TD
840 x 510 x 1200 mm	1	1495FWB120TD

Galvanized Top Foldable Workbenches



1495FWBTS



840 x 510 x 1200 mm	1	1495FWB120TS
---------------------	---	--------------

METALLIC TOOL BOXES

Metallic Tool Box Aviation Toolkit - 129 Pcs



1483KHD3RB-FF1



335 x 260 x 565 mm	1	1483KHD3RB-FF1
--------------------	---	----------------

1483KHD3RB

FF3A01

FF3A02

FF3A03

FF3A04



Metallic Tool Box Aviation Toolkit - 152 Pcs



1483KHD3RB-FF2



335 x 260 x 565 mm	1	1483KHD3RB-FF2
--------------------	---	----------------

1483KHD3RB

FF3A05

FF3A06

FF3A07

FF3A08

2509

2535F2

3625N-32

481-400

7762



Metallic Tool Box General Purpose Toolkit - 193 Pcs



1483KHD3RB-FF3



335 x 260 x 565 mm

1 1483KHD3RB-FF3

1483KHD3RB	
FF3A09	
FF3A10	
FF3A11	
FF3A12	

Metallic Tool Box General Purpose Toolkit - 146 Pcs



1483KHD3RB-FF4



335 x 260 x 565 mm

1 1483KHD3RB-FF4

1483KHD3RB	
FF3A10	
FF3A11	
FF3A12	
FF3A13	

Metallic Tool Box Aviation Toolkit - 137 Pcs



1483KHD3RB-FF5



335 x 260 x 565 mm

1 1483KHD3RB-FF5

1483KHD3RB	
FF3A14	
FF3A15	
FF3A16	
FF3A17	

Metallic Tool Box Aviation Tool Kit - 124 pcs



1483KHD3RB-FF7



335 x 260 x 565 mm

1 1483KHD3RB-FF7

1483KHD3RB	
481-400	
2535F1	

7762	
6950SL	
6960, 6962	
6956	
7752	
6966	
6972H	
A6700DZ-3/16, A6700DZ-7/32, A6700DZ-1/4, A6700DZ-9/32, A6700DZ-5/16, A6700DZ-11/32, A6700DZ-3/8, A6700DZ-7/16, A6700DZ-1/2, A6700DZ-9/16	
A6710DZ-1/4, A6710DZ-5/16, A6710DZ-11/32, A6710DZ-3/8, A6710DZ-7/16	
A6800DZ-3/16, A6800DZ-7/32, A6800DZ-1/4, A6800DZ-9/32, A6800DZ-5/16, A6800DZ-11/32, A6800DZ-3/8, A6800DZ-7/16, A6800DZ-1/2, A6800DZ-9/16	
A6800DM-4	
BE-9780	
59/S28-4	
59S/TS-1/4	
9070 P	
808050	
2058-BR	
KE18-01	
1150-1/2H/P	
2047-1-5.5	
2047PR-1-2	
BE-8030	
BE-8150	
BE-8260	
BE-8350	
BE-8602	
BE-8610, BE-8620	
5515T-52	
1177-SCRIBE	
SR300-E	
704Z-3/32	
MTB-3-16-M-E	
2101GC-160IP	
2427 GC-200IP	
2855	
8224CIP	
2628 GC-160IP	
2632	
3734-3, 3734-5, 3734-8	
1300Z-1/4-5/16	
1320RZ-1/4-5/16, 1320RZ-3/8-7/16	
1952Z-15/16, 1952Z-1, 1952Z-1/4, 1952Z-5/16, 1952Z-11/32, 1952Z-3/8, 1952Z-7/16, 1952Z-1/2, 1952Z-9/16, 1952Z-5/8, 1952Z-11/16, 1952Z-3/4, 1952Z-13/16, 1952Z-7/8	
6Z-19/32-11/16	
3625N-32	



Heavy Duty Metallic Tool Boxes with 4 Drawers



1483KHD4RB

390 x 260 x 593 mm 15200 g 1 1483KHD4RB

Heavy Duty Metallic Tool Boxes with 3 Drawers



1484THD3RB

300 x 220 x 520 mm 12.40 kg 1 1484THD3RB

Heavy Duty Metallic Tool Boxes with 3 Drawers



1483KHD3RB

305 x 233 x 523 mm 13050 g 1 1483KHD3RB

Metallic Tool Boxes with 3 Drawers



1483K3RB

334 x 260 x 523 mm 10200 g 1 1483K3RB

Metallic Tool Boxes with 2 Drawers



1483K2RB

277 x 257 x 525 mm 8200 g 1 1483K2RB

Carts for 1483K Metallic Boxes



1483CART

200 x 270 x 655 mm 6.02 kg 1 1483CART

Foam Inlay Imperial Toolset for our metallic cases 1483K & 1483KHD Series - 79 Pcs



FF3A01

64 x 245 x 505 mm 1 FF3A01

A6700DZ-1/2, A6700DZ-1/4, A6700DZ-11/32, A6700DZ-3/8, A6700DZ-5/16, A6700DZ-7/16, A6700DZ-7/32, A6700DZ-9/32		
A6710DZ-3/8, A6710DZ-5/16, A6710DZ-7/16		
A6800DZ-1/4, A6800DZ-5/16, A6800DZ-7/32, A6800DZ-9/32		
A7400DM-10, A7400DM-13		
A7400DZ-1/2, A7400DZ-11/16, A7400DZ-3/4, A7400DZ-5/8, A7400DZ-9/16		
A7402DZ-1/2, A7402DZ-3/8, A7402DZ-7/16, A7402DZ-9/16		
1320RZ-1/4-5/16, 1320RZ-3/8-7/16		
59/S28-4		
6Z-1.1/16-1.1/4, 6Z-1-1.1/8, 6Z-7/8-15/16		
6950SL		
6956		
6958		
6960, 6961		
6966		
6972H		
7407H		
7750SL		
7752		
7760, 7761		
7764		
7765		
7766		
7800DZ-1, 7800DZ-13/16, 7800DZ-7/8		
8164-1/2		
8171		

Foam Inlay Imperial Toolset for our metallic cases 1483K & 1483KHD Series - 13 Pcs



FF3A02



39 x 210 x 445 mm

1 FF3A02

BE-3529		
BE-8020L		
BE-8155		
BE-8260		
BE-8601		
BE-8611, BE-8621		
1150-1/2H/P		
1177-SCRIBE		
2047-1.2-8		
2047PR-1-2		
5515T-52		
9715-14-250		

Foam Inlay Imperial Toolset for our metallic cases 1483K & 1483KHD Series - 12 Pcs



FF3A03



48 x 210 x 450 mm

1 FF3A03

MTB-3-16-M-E	
2101GC-160IP	
2421GC-180IP	
2855 D	
3658A-2, 3658A-3, 3658A-5	
8224CIP	
0454800500, 1151-1, 1151-2, BFLB01	

Foam Inlay Imperial Toolset for our metallic cases 1483K & 1483KHD Series - 20 Pcs



FF3A04



45 x 210 x 445 mm

1 FF3A04

U-XID1415A, U-XID1618A, U-DS2018A	
1300Z-1/2-9/16, 1300Z-1/4-5/16, 1300Z-3/8-7/16, 1300Z-5/8-3/4, 1300Z-7/8-15/16, 1300Z-25/32-13/16, 1300Z-19/32-11/16	
6Z-19/32-11/16, 6Z-25/32-13/16, 6Z-3/8-7/16, 6Z-5/8-3/4, 6Z-1/4-5/16, 6Z-1/2-9/16	
9070C	
1931Z-7/32, 1931Z-1/4	
8157-15	

Foam Inlay Imperial Toolset for our metallic cases 1483K & 1483KHD Series - 98 Pcs



FF3A05



60 x 245 x 510 mm

1 FF3A05

A6700DZ-1/2, A6700DZ-1/4, A6700DZ-11/32, A6700DZ-3/16, A6700DZ-3/8, A6700DZ-5/16, A6700DZ-7/16, A6700DZ-7/32, A6700DZ-9/16, A6700DZ-9/32	
A6710DZ-1/4, A6710DZ-11/32, A6710DZ-3/8, A6710DZ-5/16, A6710DZ-7/16	
A6800DM-4	
A6800DZ-1/2, A6800DZ-1/4, A6800DZ-11/32, A6800DZ-3/8, A6800DZ-5/16, A6800DZ-7/16, A6800DZ-3/16, A6800DZ-7/32, A6800DZ-9/16, A6800DZ-9/32	

A7400DZ-1/2, A7400DZ-11/16, A7400DZ-13/16, A7400DZ-17/32, A7400DZ-19/32, A7400DZ-3/4, A7400DZ-5/8, A7400DZ-9/16

59/S28-4	
BE-9780	
KE18-01	
1544	
2058-BR	
59S/TS-1/4	
6950SL	
6956	
6960, 6962	
6966	
6972H	
7407H	
7752	
7750SL	
7760, 7761	
7764	
7765	
7766	
808050	
9071C	
8164-1/2	

Foam Inlay Imperial Toolset for our metallic cases 1483K & 1483KHD Series - 16 Pcs



FF3A06



40 x 205 x 450 mm

1 FF3A06

BE-8030		
BE-8150, BE-8155		
BE-8260		
BE-8350		
BE-8602		
BE-8610, BE-8620		
1177-SCRIBE		
2047-1-5.5		
2047PR-1-2		
5515T-52		
704Z-3/32		
1150-1/2H/P		
1179-FLX-2		



Foam Inlay Imperial Toolset for our metallic cases 1483K & 1483KHD Series - 11 Pcs



FF3A07



39 x 202 x 450 mm

1 FF3A07

MTB-3-16-E	
2101GC-160IP	
2427 GC-200IP	
2628 GC-160IP	
2632	
2650	
2855	
3734-3, 3734-5, 3734-8	
8224CIP	

Foam Inlay Imperial Toolset for our metallic cases 1483K & 1483KHD Series - 23 Pcs



FF3A08



43 x 205 x 450 mm

1 FF3A08

1320RZ-1/2-9/16, 1320RZ-5/16-11/32, 1320RZ-1/4-5/16, 1320RZ-3/8-7/16	
1952Z-1/2, 1952Z-1/4, 1952Z-11/16, 1952Z-11/32, 1952Z-13/16, 1952Z-3/4, 1952Z-3/8, 1952Z-5/16, 1952Z-5/8, 1952Z-7/16, 1952Z-7/8, 1952Z-9/16	
6Z-19/32-11/16, 6Z-1/2-9/16, 6Z-1/4-5/16, 6Z-13/16-7/8, 6Z-3/8-7/16, 6Z-5/16-11/32, 6Z-5/8-3/4	

Foam Inlay Metric Toolset for our metallic cases 1483K & 1483KHD Series - 95 Pcs



FF3A09



65 x 250 x 515 mm

1 FF3A09

A6800DM-7, A6800DM-6, A6800DM-5.5, A6800DM-11, A6800DM-10, A6800DM-9, A6800DM-8, A6800DM-13, A6800DM-12	
A7402DM-19, A7402DM-18, A7402DM-17, A7402DM-12, A7402DM-11, A7402DM-10, A7402DM-16, A7402DM-15, A7402DM-14, A7402DM-13	
1544	
2058-BR	
6700SM-8, 6700SM-7, 6700SM-6, 6700SM-5.5, 6700SM-12, 6700SM-11, 6700SM-10, 6700SM-9, 6700SM-13	
6709M-8, 6709M-6, 6709M-5, 6709M-4, 6709M-3	
6709PH-2, 6709PH-1, 6709PH-3	
6709TORX-T25, 6709TORX-T20, 6709TORX-T15, 6709TORX-T10, 6709TORX-T40, 6709TORX-T30, 6709TORX-T27, 6709TORX-T9, 6709TORX-T8	
6950SL	
6954	
6956	
6958	
6960, 6961, 6962, 6962L	
6966	
6972H	
7400SM-8, 7400SM-7, 7400SM-6, 7400SM-19, 7400SM-18, 7400SM-17, 7400SM-22, 7400SM-12, 7400SM-11, 7400SM-10, 7400SM-9, 7400SM-16, 7400SM-15, 7400SM-14, 7400SM-13	
7407H	
7409M-10, 7409M-8, 7409M-7, 7409M-6, 7409M-5, 7409M-4, 7409M-3	
7409TORX-T27, 7409TORX-T25, 7409TORX-T50, 7409TORX-T45, 7409TORX-T40, 7409TORX-T30	
7750SL	
7754	
7758	
7760, 7761	
7764	
7765	
7766	
8164-1/2	

Foam Inlay Metric Toolset for our metallic cases 1483K & 1483KHD Series - 53 Pcs



FF3A10



39 x 205 x 445 mm

1 FF3A10

BE-8020L, BE-8030	
BE-8155	
BE-8260	
BE-8350	
BE-8601, BE-8602	
BE-8610, BE-8620	
BE-9770	
2047-0.8-4	
2047PR-1-2	
808050P	
808050S	
59S/31-1	

Cantilever Metallic Box with Foams General Purpose Tool Kit - 69 pcs



3149-ORFF1



220 x 220 x 560 mm

1 3149-ORFF1

111M-19, 111M-18, 111M-17, 111M-16, 111M-15, 111M-14, 111M-13, 111M-12, 111M-11, 111M-10, 111M-8, 111M-9	
2953-250	
224 D	
2171G-160	
2470 G-200	
BE-9770	
611-3.5-75, 611-5.5-125, 611-6.5-150	
613-3-100, 613-4-125	
615-2-25, 615-1-100, 615-2-125, 615-3-150	
KBSK-01	
MTG-5-19-E	
482-30	
3625W-28	

3745-150	
3740-150	
3734-3, 3734-5	
3735-5-120	
3149-OR	
2678 G-200	
8160-10, 8160-5	
8158-10	
SBS81	
8166	
7772H	
7800SM-15, 7800SM-16, 7800SM-13, 7800SM-14, 7800SM-19, 7800SM-20, 7800SM-17, 7800SM-18, 7800SM-23, 7800SM-24, 7800SM-21, 7800SM-22, 7800SM-27, 7800SM-32, 7800SM-30, 7800SM-11, 7800SM-12, 7800SM-10	

Cantilever Metallic Box General Purpose Tool Kit - 69 pcs



3149-ORTS1

1 3149-ORTS1

220 x 220 x 560 mm

111M-19, 111M-18, 111M-17, 111M-16, 111M-15, 111M-14, 111M-13, 111M-12, 111M-11, 111M-10, 111M-9, 111M-8	
S240	
2953-250	
224 D	
2171G-160	
2678 G-200	
2470 G-200	
BE-9770	
611-3.5-75, 611-5.5-125, 611-6.5-150	
613-3-100, 613-4-125	
615-2-25, 615-1-100, 615-2-125, 615-3-150	
KBSK-01	
MTG-5-19-E	
482-30	
3625W-28	
3745-150	
3740-150	
3734-3, 3734-5	
3735-5-120	
3149-OR	

Wheeled Cantilever Metallic Tool Box



1497MBW

1 1497MBW

549 x 400 x 1213 mm 250 kg

Metallic Tool Boxes with 5 Compartments and Locking Capability



3149-OR

1 3149-OR

200 x 220 x 530 mm 4370 g

Cantilever Style Tool Boxes with 7 Compartments



1497MBF750

1 1497MBF750

250 x 200 x 530 mm 15 kg

Cantilever Style Tool Boxes with 5 Compartments



1497MBF550

1 1497MBF550

200 x 200 x 530 mm 12 kg

Cantilever Style Tool Boxes with 3 Compartments



1497MBF350

1 1497MBF350

160 x 200 x 530 mm 10 kg

Metallic Tool Boxes with 3/5 Compartments and Locking Capability



9601

1 960100010

190 x 210 x 300 mm 2450 g

190 x 210 x 400 mm 3400 g

190 x 210 x 500 mm 3670 g

245 x 210 x 400 mm 4400 g

245 x 210 x 500 mm 4840 g



Mason Tool Chests 530 mm x 290 mm x 290 mm



1496MB2

290 x 290 x 530 mm 40 kg 1 1496MB2

Mason Tool Chests 690 mm x 360 mm x 310 mm



1496MB3

310 x 360 x 690 mm 60 kg 1 1496MB3

Mason Tool Chests 830 mm x 440 mm x 340 mm



1496MB4

340 x 440 x 830 mm 80 kg 1 1496MB4

Mason Tool Chests 910 mm x 530 mm x 530 mm



1496MB5

530 x 530 x 910 mm 150 kg 1 1496MB5

PLASTIC BOXES & CASES

Plastic Tool Box General Purpose Tool Kit - 37 pcs



4750PTB65TS5

285 x 300 x 650 mm 1 4750PTB65TS5

2430 D-140 IP	
2630D-160	
MT-TS-3	
9572	
BE-9884	
2446	
SL25	
427-16	

670 mm Heavy Duty Plastic Tool Boxes



4750PTBW67

420 x 472 x 675 mm 50 kg 1 4750PTBW67

Blow Mould Case with Adjustable Torque Wrench and Impact Socketry Toolkit - 11 pcs



4750BMC10FF1

84 x 341 x 447 mm 1 4750BMC10FF1

4750BMC10	
BWSHK21	
BWSMB15	
BWSMB17	
BWSS12P5	
BWTVCTT355	
74W9-200	
9R-1/2	

470 mm Heavy Duty Plastic Tool Boxes



4750PTBW47

60 l 30 kg 1 4750PTBW47

650 mm Heavy Duty Plastic Tool Boxes



4750PTB65



285 x 300 x 650 mm

2 4750PTB65

600 mm Heavy Duty Plastic Tool Boxes



4750PTB60



37 l

20 kg

3 4750PTB60

500 mm Heavy Duty Plastic Tool Boxes



4750PTB50



27 l

20 kg

3 4750PTB50

Double Wall Shock Absorbing Case



4750BMC



51 x 117 x 260 mm
67 x 214 x 230 mm
70 x 230 x 280 mm
90 x 230 x 320 mm
93 x 257 x 357 mm
76 x 256 x 355 mm
80 x 287 x 380 mm
105 x 297 x 393 mm
84 x 341 x 450 mm

1 4750BMC3
1 4750BMC4
1 4750BMC5
1 4750BMC5.5
1 4750BMC6
1 4750BMC7
1 4750BMC9
1 4750BMC9.5
1 4750BMC10

TEXTILE & LEATHER EQUIPMENT

Wheeled Textile Bag MRO Toolkit - 72 Pcs



4750FB2W-TS001



390 x 400 x 685 mm

1 4750FB2W-TS001

4750FB2W-24A

SL25

BE-8030, BE-8242

S240

BE-8155

BE-8600, BE-8610, BE-8620

BE-8800, BE-8810, BE-8820

BE-8040S

2628 G-180



2101G-180

7224

1520 G

MTB-5-25

MA421

268

325

479-16

KERU-01

BFLA01

5515T

9071

Closed Top Bag MRO Toolkit - 61 Pcs



4750FB2-19TS001



500 mm

250 mm

1 4750FB2-19TS001

4750FB2-19A

BE-8010S, BE-8040S, BE-8050S, BE-8220S

BE-8610S, BE-8620S, BE-8630S

BE-8800S, BE-8820S, BE-8830S

706-4

PC-12-VEN

1-210-08-2-2

2101G-180

2233 D-200

2628 G-180

268

3830-20-VIP, 3830-25-VIP

3834-ARBR-730

4130

424P-16, 424P-20, 424P-25

428-16

484-1250

806-1-1

8231

9031

SL25



Fabric Tool Bag Service Engineer's Toolkit - 51 Pcs



4750FB4-18TS001

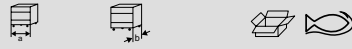

450 mm 190 mm 1 4750FB4-18TS001

4750FB4-18	
2101G-160	
2628 G-180	
2430 G-160	
1RM/SH8	
7223	
2233 D-200	
SL25	
9070	
9031	
483-20	
BE-8020, BE-8040	
BE-8150, BE-8155	
BE-8610, BE-8620	
SC127	
SQZ150003	
BE-9777	
MTB-5-25	

Leather Bag Electrician Toolkit - 28 Pcs



3049-2



180 x 435 x 270 mm 1 3049-2

268	
5470-140	
111M-7, 111M-8, 111M-10, 111M-13	
2744	
2427 S-200	
8045LVDE	
BE-9765	
2705R	
481-300	
9072 P	
2628 S-180	
2101S-160	
BE-8820S	
BE-8220S, BE-8040S, BE-8050S, BE-8255S	
BE-8610S, BE-8620S	
B146.006.100	
4750-FOLTTC-1	

Leather Bag Electrician Toolkit - 16 Pcs



982000170



290 x 195 x 440 mm 1 982000170

4750-FOLTTC-1	
2101GC-160IP	
2800 N	
2630GC-160IP	
2421GC-160	
2521GC-160	
8071 C IP	
B196.065.150, B196.055.125, B196.030.100, B196.040.100	
B197.002.100, B197.001.080	
SC127	
2820EF2	
MTB-3-16	
6224	

Leather Bag General Purpose Toolkit - 32 Pcs



982000320

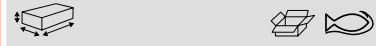

280 x 200 x 435 mm 1 982000320

4750-FOLTTC-1	
2101D-160IP	
224 D	
2630D-180	
2430 D-160 IP	
8071 C IP	
483-20	
6M/8C	
541D-180	
2951-180	
B191.030.075, B191.040.100	
B190.100.200, B190.065.150	
B192.001.100, B192.002.125	
SC127	
2820EF2	
BE-9777	
MTB-3-16	

Leather Bag General Purpose Toolkit - 34 Pcs



982000350



280 x 200 x 440 mm 1 982000350

4750-FOLTTC-1	
2101GC-160IP	
2630GC-180IP	

2900-180	
2800-180	
1998M/10T	
8072 C IP	
2951-250	
B190.100.200, B190.065.150, B190.040.100	
B192.001.100, B192.002.125	
SC127	
6M/8C	
479-16	
2430 GC-200 IP	
1-110-08-2-2	
6224	

Fabric tool folder with foam, 51 pcs



4750FB5BFF1
 62 x 275 x 330 mm 1 4750FB5BFF1

4750FB5B	
808050P	
MTB-5-25	
2101G-160	
2628 G-180	
BE-9578	
9070	
59/S31B	

Mini Folder Case General Purpose Toolkit - 36 Pcs



4750FB5ATS001
 275 mm 170 mm 1 4750FB5ATS001

4750FB5A	
2058/S26	
808050	
8070	
2101G-160	
2628 G-180	

Zipper Wallet General Purpose Toolkit - 7 Pcs



9848
 50 x 275 x 330 mm 1 9848

8160	
7890	
8070	
BE-8020, BE-8040	
BE-8610	
TL AA-SA-SL	

Zipper Wallet Electrician Toolkit - 17 Pcs



9852
 360 x 40 x 240 mm 1 9852

7890	
8160	
8070	
TL AA-SA-SL	

2421 G-160	
2101G-160	
2628 G-180	
BE-8210, BE-8040	
BE-8150, BE-8155	
BE-8600, BE-8610, BE-8620	
8045LVDE	
K-AP-1	

Zipper Wallet Electrician Toolkit - 7 Pcs



9841
 275 x 48 x 330 mm 1 9841

7190	
7890	
TL AA-SA-SL	
BE-8020, BE-8040	
BE-8610	
8070	

Backpack with Anti-Slip Plastic Hard Bottom



4750FB8
 560 x 190 x 335 mm 4 4750FB8



24 L Open Top Fabric Tool Bags with Rigid Base



3100TB



345 x 240 x 485 mm

1 3100TB

32 L Closed Top Fabric Tool Bags with Rigid Base



4750FB2-19A



370 x 230 x 470 mm

4 4750FB2-19A

12 L Electrician Fabric Tool Bags



4750FB3-12



285 x 190 x 285 mm

1 4750FB3-12

32 L Open Top Fabric Tool Bags with Rigid Base



4750FB1-19A



355 x 230 x 470 mm

1 4750FB1-19A

48 L Closed Top Fabric Tool Bags with Rigid Base



4750FB2-24A



380 x 260 x 600 mm

2 4750FB2-24A

17 L Laptop and Tool Bags



4750FB4-18



350 x 150 x 430 mm

4 4750FB4-18

32 L Open Top Deluxe Fabric Tool Bags with Rigid Base



4750FB1-19B



365 x 225 x 480 mm

4 4750FB1-19B

73 L Wheeled Fabric Tool Bags with Telescopic Handle



4750FB2W-24A



385 x 325 x 665 mm

1 4750FB2W-24A

21 L Closed Top Fabric Tool Bags



4750FB6-13



275 x 250 x 310 mm

1 4750FB6-13

36 L Closed Top Fabric Tool Bags



4750FB6-19



290 x 265 x 480 mm

1 4750FB6-19

6 L Medium Fabric Tool Folders with Rubberized Handle



4750FB5B



62 x 275 x 330 mm

1 4750FB5B

11 L Fabric Tool Folder with Rubberised Handle for 2x 1/3 Fit&Go Foams



4750FB5-FG2



90 x 210 x 470 mm

1 4750FB5-FG2

Fabric Tool Bags for 416-SET-1



4750-LV-1



85 x 43 x 1800 mm

1 4750-LV-1

51 x 43 x 1800 mm

1 4750-LV-2

12 L Max Fabric Tool Folders with Rubberized Handle



4750FB5C



80 x 305 x 403 mm

8 4750FB5C

Folding Front Leather Tool Cases



4750-FOLTC-1



290 x 195 x 440 mm

1 4750-FOLTC-1

2.4 L Mini Fabric Tool Folders



4750FB5A



50 x 168 x 273 mm

1 4750FB5A

8 L Fabric Tool Folder with Rubberised Handle for 1x 1/3 Fit&Go Foam



4750FB5-FG1



65 x 210 x 470 mm

1 4750FB5-FG1

Tube Style Leather Tool Cases



4750-TOCST-1



220 x 170 x 495 mm

1 4750-TOCST-1



Electrician Leather Tool Cases



4750-VDEC



290 x 190 x 445 mm

1 4750-VDEC

Zip Bags 3 Units Set - 90 mm



4750FB7-01



135 x 10 x 215 mm

60 4750FB7-01

Zip Bags 3 Units Set - 145 mm



4750FB7-02



205 x 10 x 310 mm

60 4750FB7-02

Orange Zip Bag - 90 mm



4750FB7ORLT



135 x 10 x 215 mm

120 4750FB7ORLT

Orange Zip Bag - 145 mm



4750FB7ORBG



205 x 10 x 310 mm

120 4750FB7ORBG

Heavy Duty Belts with Cushion and Stainless Steel Twin-Pin Buckle



4750-HDB-2



190 x 50 x 900 mm

1 4750-HDB-2

Heavy Duty Belt Set



4750-HDBS-2



330 x 170 x 900 mm

1 4750-HDBS-2

Quick Release Fabric Adjustable Belts



4750-QRFB-1



50 x 4 x 1180 mm

1 4750-QRFB-1

Junior Three Pouch Belt Set



4750-JU3PB



125 x 55 x 395 mm

1 4750-JU3PB-1

Heavy Duty Leather Belts



4750-HDLB



47 x 4 x 1380 mm

1 4750-HDLB-1

Two Pocket Fixings Pouches



4750-2PP



285 x 130 x 265 mm

1 4750-2PP-1

Multipurpose Holders



4750-MPH-1



240 x 50 x 155 mm

1 4750-MPH-1

Roll Covers for Tools



4750-ROCO-1



320 x 5 x 370 mm

1 4750-ROCO-1

Right and Left Handed Drill Holsters



4750-DHO-3



320 x 73 x 175 mm

1 4750-DHO-3

Squeeze Knife Holders



4750-KNHO-1



205 x 35 x 105 mm

1 4750-KNHO-1

Flooring and Roofing Knee Pads



4750-KP



200 x 30 x 170 mm

1 4750-KP-1

Electrician's Pouches



4750-EP



345 x 120 x 260 mm

1 4750-EP-1

Vertical Mobile Phone Holders



4750-VMPH-1



170 x 35 x 100 mm

1 4750-VMPH-1

Braces with Clips



4750-BWC-1



750 x 20 x 105 mm

1 4750-BWC-1





BAHCO

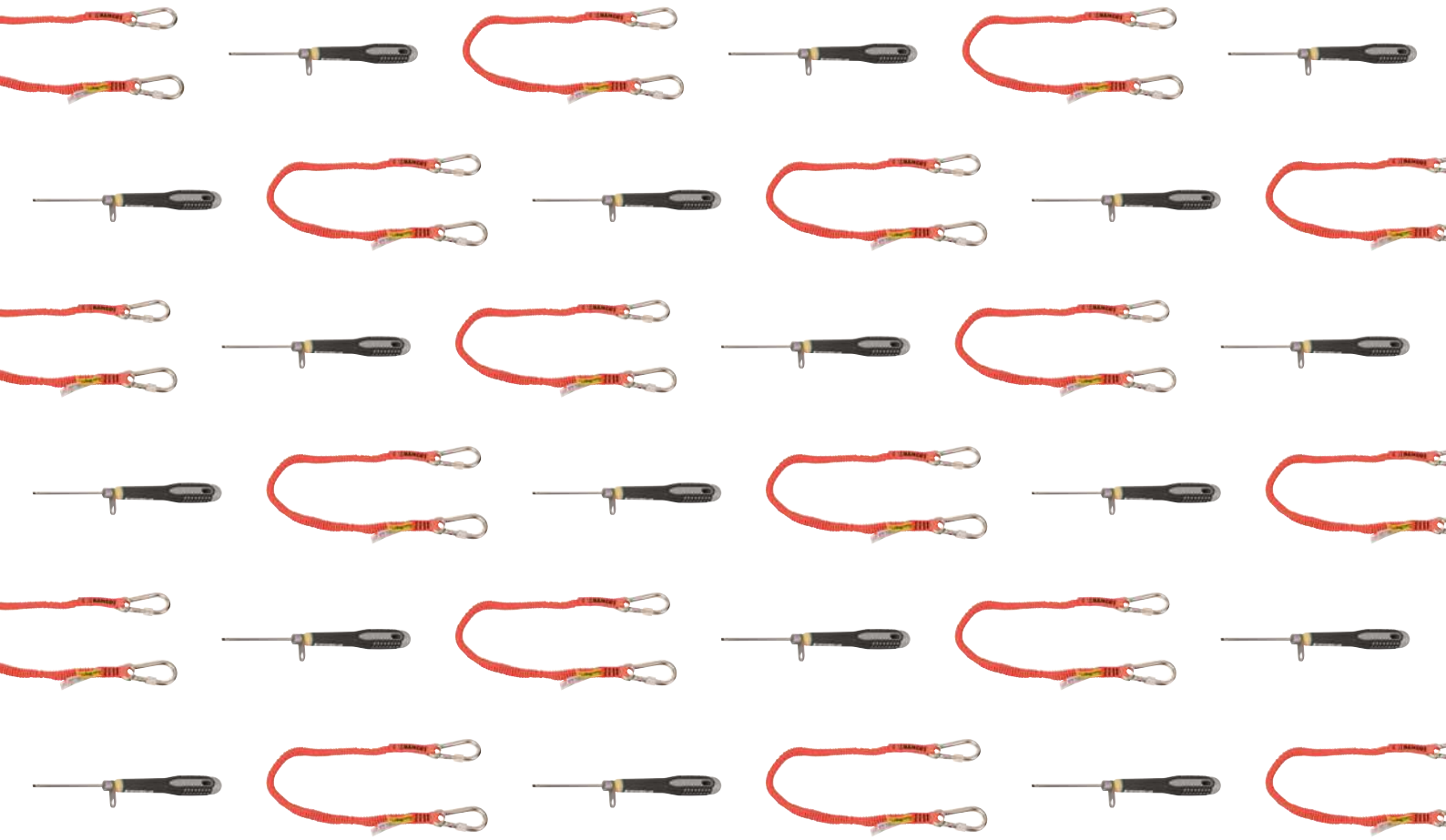

Tools @ Height



TOOL STORAGE & LANYARDS

High Visibility Orange Strap Lanyards with Swivel Carabiner 1 kg



3875-LY60



g



135 g

1 3875-LY60

Strap Lanyards with Fixed Carabiner and Interchangeable Loop 1 kg



3875-LY3

g



125 g

8 3875-LY3

Wrist Lanyards with Exchangeable Loop and Barrel Lock 1 kg



3875-WL1

g



40 g

8 3875-WL1

Connecting Loops for Lanyard



3875-QL1

g



40 g

8 3875-QL1

Retractable Lanyards with Fixed Carabiner 0.9 kg



3875-RL1

g



200 g

1 3875-RL1

Connecting Loops for Retractable Lanyard



3875-QRL1

g



40 g

1 3875-QRL1

Retractable Lanyards with Fixed Carabiner 1 kg



3875-RL2

g



212 g

1 3875-RL2

High Visibility Orange Strap Lanyards with Fixed Carabiner 3 kg



3875-LY70



g



172 g

1 3875-LY70

Strap Lanyards with Fixed Carabiner and Locking Device 3 kg



3875-LY4



g



180 g

8 3875-LY4

Strap Lanyards with Fixed Carabiner 3 kg



3875-LY1

g



170 g

8 3875-LY1

Strap Lanyards with Fixed Carabiner and Fixed Loop 3 kg



3875-LY2

g



120 g

8 3875-LY2

High Visibility Orange Strap Lanyards with Fixed Carabiner 6 kg



3875-LY8



330 g



1 3875-LY8

Coiled Lanyards with 1.5 mm Wire Loop String



439000001



130 g



1 439000001

Coiled Lanyards with Swivel Carabiner 3 kg



439000003



160 g



1 439000003

High Visibility Orange Strap Lanyards with Fixed Carabiner 12 kg



3875-LY10



270 g



1 3875-LY10

Steel String Lanyards



3875-SL1



10 g



1 3875-SL1

High Visibility Orange Strap Lanyards with Plastic Clip



439000004



13 g



1 439000004

Coiled Lanyards with 1 mm Wire Loop String



439000000



100 g



1 439000000

Coiled Lanyards with Swivel Carabiner 2 kg



439000002



130 g



1 439000002

Bags for Working at Height



3875-HB10



260 x 130 x 130 mm



1 3875-HB10



Lifting Bags with Single Reinforced Lifting Straps



3875-HB30/3875-HB60



270 x 270 x 330 mm
340 x 340 x 620 mm

1 3875-HB30
6 3875-HB60

Backpacks with Durable Polyester Large Size



3875-BP2



240 x 340 x 440 mm

8 3875-BP2

Multipurpose Pouches with 2 Large Pockets and 4 Safety Rings for Lanyard Attachment



4750-UP-2



270 x 145 x 270 mm

1 4750-UP-2

Lifting Bags with Double Reinforced Lifting Straps



3875-HB100



390 x 390 x 890 mm

1 3875-HB100

Pouches with 2 Large Pockets and 6 Safety Rings for Lanyard Attachment



3875-MHP6



100 x 185 x 370 mm

1 3875-MHP6

Hammer Holster Belt Pouches with 1 Safety Ring for Lanyard Attachment



4750-HHO-2



110 x 65 x 165 mm

1 4750-HHO-2

Rigid Case Lifting Bags with Double Reinforced Lifting Straps



3875-SB70



790 x 300 x 750 mm

1 3875-SB70

Three Pouch Set Belts with 4 Safety Rings for Lanyard Attachment



3PB-2



80 x 270 x 1350 mm

1 4750-3PB-2

Heavy Duty Belts with 6 Safety Rings for Lanyard Attachment



4750-HDLB-TAH



50 x 120 x 1410 mm

1 4750-HDLB-TAH

WRENCHES

ERGO™ 90 Series Adjustable Wrenches with Quick Link



ergo



TAH90



Size	Quick Link	Quantity	Part Number
158mm/6"	20 mm	1	TAH9070
250mm/10"	31 mm	1	TAH9072

80 Series Adjustable Wrenches with Quick Link



TAH80



Size	Quick Link	Quantity	Part Number
110mm/4"	13 mm	1	TAH8069
155mm/6"	20 mm	1	TAH8070
205mm/8"	27 mm	1	TAH8071
255mm/10"	31 mm	1	TAH8072
305mm/12"	34 mm	1	TAH8073
380mm/15"	44 mm	1	TAH8074
460mm/18"	53 mm	1	TAH8075
110mm/4"	13 mm	1	TAH8069C
155mm/6"	20 mm	1	TAH8070C
205mm/8"	27 mm	1	TAH8071C
255mm/10"	31 mm	1	TAH8072C
305mm/12"	34 mm	1	TAH8073C
380mm/15"	44 mm	1	TAH8074C
460mm/18"	53 mm	1	TAH8075C

Podger Wrenches with Safety D-Shackle



TAH84



Size	Quick Link	Quantity	Part Number
405mm/16"	41 mm	1	TAH84-PODGER

Metric Combination Wrenches with Safety Spring



TAH111M



Size	Length	Quantity	Part Number
6 mm	112 mm	1	TAH111M-6
7 mm	120 mm	1	TAH111M-7
8 mm	130 mm	1	TAH111M-8
9 mm	136 mm	1	TAH111M-9
10 mm	144 mm	1	TAH111M-10
11 mm	153 mm	1	TAH111M-11
12 mm	160 mm	1	TAH111M-12
13 mm	165 mm	1	TAH111M-13
14 mm	177 mm	1	TAH111M-14
15 mm	185 mm	1	TAH111M-15
16 mm	195 mm	1	TAH111M-16
17 mm	200 mm	1	TAH111M-17
18 mm	208 mm	1	TAH111M-18
19 mm	215 mm	1	TAH111M-19
20 mm	240 mm	1	TAH111M-20
21 mm	250 mm	1	TAH111M-21
22 mm	250 mm	1	TAH111M-22
23 mm	270 mm	1	TAH111M-23
24 mm	270 mm	1	TAH111M-24
25 mm	290 mm	1	TAH111M-25
27 mm	310 mm	1	TAH111M-27
30 mm	330 mm	1	TAH111M-30
32 mm	345 mm	1	TAH111M-32
34 mm	347 mm	1	TAH111M-34
36 mm	400 mm	1	TAH111M-36
41 mm	438 mm	1	TAH111M-41
46 mm	500 mm	1	TAH111M-46
50 mm	540 mm	1	TAH111M-50
55 mm	560 mm	1	TAH111M-55

Imperial Combination Wrenches with Safety Spring



TAH111Z



Size	Length	Quantity	Part Number
1/4 in	112 mm	1	TAH111Z-1/4
5/16 in	130 mm	1	TAH111Z-5/16
3/8 in	140 mm	1	TAH111Z-3/8
7/16 in	153 mm	1	TAH111Z-7/16

Size	Length	Quantity	Part Number
1/2 in	169 mm	1	TAH111Z-1/2
9/16 in	177 mm	1	TAH111Z-9/16
5/8 in	195 mm	1	TAH111Z-5/8
11/16 in	200 mm	1	TAH111Z-11/16
3/4 in	218 mm	1	TAH111Z-3/4
13/16 in	250 mm	1	TAH111Z-13/16
7/8 in	250 mm	1	TAH111Z-7/8
15/16 in	270 mm	1	TAH111Z-15/16
1 in	290 mm	1	TAH111Z-1
1-1/16 in	310 mm	1	TAH111Z-1.1/16
1-1/8 in	310 mm	1	TAH111Z-1.1/8
1-1/4 in	350 mm	1	TAH111Z-1.1/4
1-5/16 in	350 mm	1	TAH111Z-1.5/16
1 3/8 in	410 mm	1	TAH111Z-1.3/8
1 7/16 in	410 mm	1	TAH111Z-1.7/16
1 1/2 in	410 mm	1	TAH111Z-1.1/2
1 5/8 in	460 mm	1	TAH111Z-1.5/8
1 11/16 in	460 mm	1	TAH111Z-1.11/16
1 3/4 in	500 mm	1	TAH111Z-1.3/4
1 13/16 in	500 mm	1	TAH111Z-1.13/16
1 7/8 in	540 mm	1	TAH111Z-1.7/8
2 in	540 mm	1	TAH111Z-2
2 1/4 in	600 mm	1	TAH111Z-2.1/4
2 3/8 in	600 mm	1	TAH111Z-2.3/8
2 5/8 in	680 mm	1	TAH111Z-2.5/8
2 3/4 in	680 mm	1	TAH111Z-2.3/4
2 7/8 in	730 mm	1	TAH111Z-2.7/8
3 in	730 mm	1	TAH111Z-3

Ratcheting Combination Wrenches with Safety Spring



TAH1RM



Size	Length	Quantity	Part Number
6 mm	128 mm	1	TAH1RM-6
7 mm	140 mm	1	TAH1RM-7
8 mm	140 mm	1	TAH1RM-8
9 mm	150 mm	1	TAH1RM-9
10 mm	159 mm	1	TAH1RM-10
11 mm	165 mm	1	TAH1RM-11
12 mm	172 mm	1	TAH1RM-12
13 in	178 mm	1	TAH1RM-13
14 in	191 mm	1	TAH1RM-14
15 in	200 mm	1	TAH1RM-15
16 in	208 mm	1	TAH1RM-16
17 mm	226 mm	1	TAH1RM-17
18 in	237 mm	1	TAH1RM-18
19 mm	248 mm	1	TAH1RM-19
21 in	290 mm	1	TAH1RM-21
22 in	361 mm	1	TAH1RM-22
24 mm	323 mm	1	TAH1RM-24
27 in	359 mm	1	TAH1RM-27
30 mm	400 mm	1	TAH1RM-30
32 in	425 mm	1	TAH1RM-32



Metric Deep Offset Double Ring End Spanners with Chrome Finish with Stainless Steel Sliding Spring



TAH2M



6x7 mm	165 mm	1	TAH2M-6-7
8x9 mm	180 mm	1	TAH2M-8-9
10x11 mm	190 mm	1	TAH2M-10-11
12x13 mm	210 mm	1	TAH2M-12-13
14x15 mm	226 mm	1	TAH2M-14-15
16x17 mm	246 mm	1	TAH2M-16-17
18x19 mm	266 mm	1	TAH2M-18-19

Metric Double Open End Wrenches with Safety Spring



TAH6M



6x7 mm	122 mm	1	TAH6M-6-7
8x9 mm	135 mm	1	TAH6M-8-9
10x11 mm	153 mm	1	TAH6M-10-11
12x13 mm	164 mm	1	TAH6M-12-13
14x15 mm	183 mm	1	TAH6M-14-15
16x17 mm	201 mm	1	TAH6M-16-17
17x19 mm	222 mm	1	TAH6M-17-19
18x19 mm	222 mm	1	TAH6M-18-19
20x22 mm	225 mm	1	TAH6M-20-22
24x27 mm	260 mm	1	TAH6M-24-27
30x32 mm	300 mm	1	TAH6M-30-32

Flare Nut Wrenches with Safety Spring



TAH1949M



8x9 mm	140 mm	1	TAH1949M-8-9
10x11 mm	150 mm	1	TAH1949M-10-11
12x14 mm	170 mm	1	TAH1949M-12-14
14x17 mm	200 mm	1	TAH1949M-14-17
19x22 mm	220 mm	1	TAH1949M-19-22
24x27 mm	255 mm	1	TAH1949M-24-27

Ring End Slogging Wrenches with D-Shackle



TAH7444SG



36 mm	205 mm	1	TAH7444SG-M-36
41 mm	230 mm	1	TAH7444SG-M-41
46 mm	240 mm	1	TAH7444SG-M-46
50 mm	255 mm	1	TAH7444SG-M-50
55 mm	270 mm	1	TAH7444SG-M-55

Metric Double Head Offset Socket Spanners with 6 x 6-Point Dynamic Drive™ with Stainless Steel Ring



TAH29



12 mm		1	TAH29M-12
6 mm		1	TAH29M-6
7 mm		1	TAH29M-7
8 mm		1	TAH29M-8
10 mm		1	TAH29M-10



9 mm		1	TAH29M-9
11 mm		1	TAH29M-11
13 mm		1	TAH29M-13
14 mm		1	TAH29M-14
15 mm		1	TAH29M-15
16 mm		1	TAH29M-16
17 mm		1	TAH29M-17
18 mm		1	TAH29M-18
19 mm		1	TAH29M-19
20 mm		1	TAH29M-20
21 mm		1	TAH29M-21
22 mm		1	TAH29M-22
23 mm		1	TAH29M-23
24 mm		1	TAH29M-24
25 mm		1	TAH29M-25
26 mm		1	TAH29M-26
27 mm		1	TAH29M-27
28 mm		1	TAH29M-28
29 mm		1	TAH29M-29
30 mm		1	TAH29M-30
32 mm		1	TAH29M-32

Switch Cabinet Wrenches with Dyneema Ready to Work at Height



TAHMK5



97x25 mm		1	TAHMK5

Ratchet Wrenches with Safety Ring and Dee Shackle



TAHSC2RM



13-17 mm	280 mm	1	TAHSC2RM-13-17
15-17 mm	280 mm	1	TAHSC2RM-15-17
19-22 mm	310 mm	1	TAHSC2RM-19-22
27-30 mm	450 mm	1	TAHSC2RM-27-30

PIPE WRENCHES

ERGO™ Swedish Model Pipe Wrenches with Wire Loop



ergo



TAH1410-TAH1420



320 mm	1 in	1	TAH1410
430 mm	1 1/2 in	1	TAH1420

Swedish Model 90° Pipe Wrenches with Bow Shackle



TAH14



210 mm	3/4 in	1	TAH140
320 mm	1 in	1	TAH141
426 mm	1 1/2 in	1	TAH142
557 mm	2-1/2 in	1	TAH143

Aluminium Pipe Wrenches with Quick Link



TAH380



253 mm	1.1/2 in	1	TAH380-10
354 mm	2 in	1	TAH380-14
455 mm	2.1/2 in	1	TAH380-18
607 mm	3 in	1	TAH380-24

SOCKETS & RATCHETS

1/4" Square Drive Sockets with Metric Hex Profile and 4 point solution



TAH08

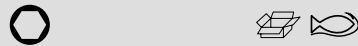

5.5 mm	1	TAH08-5.5
6 mm	1	TAH08-6
7 mm	1	TAH08-7
8 mm	1	TAH08-8
9 mm	1	TAH08-9
10 mm	1	TAH08-10
11 mm	1	TAH08-11
12 mm	1	TAH08-12
13 mm	1	TAH08-13

1/4" Square Drive Breaker Bars with Safety Spring



TAH6958B-1

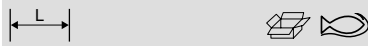

150 mm	1	TAH6958B-1
--------	---	------------

1/4" Square Drive Extension Bars with 4 Holes



TAH6960-TAH6962L



50 mm	1	TAH6960
101 mm	1	TAH6961
152 mm	1	TAH6962
355 mm	1	TAH6962L

1/4" Square Drive Universal Joints with 4 Holes



TAH6966



36 mm	1	TAH6966
-------	---	---------

1/4" Square Drive Socket Drivers for Metric Hex Head Screws with 4 Points Solution



TAH08-H

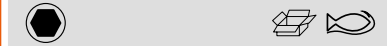

3 mm	1	TAH08-H3
4 mm	1	TAH08-H4
5 mm	1	TAH08-H5
6 mm	1	TAH08-H6
8 mm	1	TAH08-H8

1/4" Square Drive Socket Drivers for Phillips Head Screws with 4 Points Solution



TAH08-PH



1	1	TAH08-PH1
2	1	TAH08-PH2
3	1	TAH08-PH3



1/4" Square Drive Socket Drivers for TORX® Head Screws with 4 Points Solution



TAH08TTAH



Size	Quantity	Part Number
T-8	1	TAH08-T8
T-9	1	TAH08-T9
T-10	1	TAH08-T10
T-15	1	TAH08-T15
T-20	1	TAH08-T20
T-25	1	TAH08-T25
T-27	1	TAH08-T27
T-30	1	TAH08-T30
T-40	1	TAH08-T40

1/4" Square Drive Reversible Ratchets with Sealed Dyneema String



TAH6950



Length	Quantity	Part Number
120 mm	1	TAH6950

1/4" Square Drive Spinner Handles with Safety Chuck



TAH6956-1



Length	Quantity	Part Number
150 mm	1	TAH6956-1

1/2" Square Drive Sockets with Metric Bi-Hex Profile and 4 Point Solution



TAH16B



Size	Quantity	Part Number
8 mm	1	TAH16B-8
10 mm	1	TAH16B-10
11 mm	1	TAH16B-11
12 mm	1	TAH16B-12
13 mm	1	TAH16B-13
14 mm	1	TAH16B-14
15 mm	1	TAH16B-15
16 mm	1	TAH16B-16
17 mm	1	TAH16B-17
18 mm	1	TAH16B-18
19 mm	1	TAH16B-19
21 mm	1	TAH16B-21
22 mm	1	TAH16B-22
24 mm	1	TAH16B-24
25 mm	1	TAH16B-25
27 mm	1	TAH16B-27
30 mm	1	TAH16B-30
32 mm	1	TAH16B-32

1/2" Square Drive Sockets with Imperial Bi-Hex Profile and 4 Point Solution



TAH16B"



Size	Quantity	Part Number
1/2 in	1	TAH16B-1/2
9/16 in	1	TAH16B-9/16
5/8 in	1	TAH16B-5/8
11/16 in	1	TAH16B-11/16
3/4 in	1	TAH16B-3/4
13/16 in	1	TAH16B-13/16
7/8 in	1	TAH16B-7/8
15/16 in	1	TAH16B-15/16
1 in	1	TAH16B-1
1 1/16 in	1	TAH16B-1.1/16
1 1/8 in	1	TAH16B-1.1/8
1 1/4 in	1	TAH16B-1.1/4

1/2" Breaker Bars with Safety Spring



TAH8158B-1



Length	Quantity	Part Number
256 mm	1	TAH8158B-1

1/2" Extension Bars with 4 Holes



TAH8160-8162

Length	Quantity	Part Number
125 mm	1	TAH8160
250 mm	1	TAH8162

1/2" Universal Joints with 4 Point Solution



TAH8166

Length	Quantity	Part Number
67 mm	1	TAH8166

1/2" Square Drive Socket Drivers for Metric Hex Head Screws with 4 point solution



TAH16H

4 mm	1 TAH16-H4
5 mm	1 TAH16-H5
6 mm	1 TAH16-H6
7 mm	1 TAH16-H7
8 mm	1 TAH16-H8
10 mm	1 TAH16-H10
12 mm	1 TAH16-H12
14 mm	1 TAH16-H14
17 mm	1 TAH16-H17
19 mm	1 TAH16-H19

1/2" Square Drive Socket Drivers for Imperial Hex Head Screws with 4 point solution



TAH16H"

1/4 in	1 TAH16H-1/4
5/16 in	1 TAH16H-5/16
3/8 in	1 TAH16H-3/8
7/16 in	1 TAH16H-7/16
1/2 in	1 TAH16H-1/2
9/16 in	1 TAH16H-9/16
5/8 in	1 TAH16H-5/8

1/2" Square Drive Socket Drivers for TORX® Head Screws with 4 Points Solution



TAH16-T

T30	1 TAH16-T30
T40	1 TAH16-T40
T45	1 TAH16-T45



T50	1 TAH16-T50
T55	1 TAH16-T55
T60	1 TAH16-T60

1/2" Reversible Ratchets with Sealed Dyneema String



TAH8150-1/2

 270 mm	1 TAH8150-1/2

1/2" Square Drive Socket Set with Metric Hex Profile and Pear Head Ratchet - 22 pcs for Working at Height



TAH16BM/22

85 x 350 x 445 mm	1 TAH16BM/22

1/2" Square Drive Socket Set with Imperial Hex Profile and Pear Head Ratchet - 17 pcs for Working at Height



TAH16BZ/17

80 x 300 x 380 mm	1 TAH16BZ/17

3/4" Square Drive Sockets with Metric Hex Profile and 4 point solution



TAH24B

27 mm	1 TAH24B-27
30 mm	1 TAH24B-30
32 mm	1 TAH24B-32
36 mm	1 TAH24B-36
38 mm	1 TAH24B-38
41 mm	1 TAH24B-41
46 mm	1 TAH24B-46
50 mm	1 TAH24B-50

3/4" Square Drive Extension Bars with 4 Point Solution



TAH8961

 200 mm	1 TAH8961

3/4" Square Drive Universal Handles with Loop Wire



TAH8953

 500 mm	1 TAH8953



3/4" Square Drive Reversible Ratchet Heads with Loop Wire



TAH8950N/A



170 mm	1 TAH8950N/A

Stubby Pin Releasers for TAH Sockets



TAHPINRELEASER



4 mm 45 mm	1 TAHPINRELEASER

SCREWDRIVERS

ERGO™ Slotted Screwdrivers with Safety Chuck



TAHBE8020L-TAHBE8252



3.2 mm 75 mm	1 TAHBE-8020L
3.5 mm 75 mm	1 TAHBE-8030
4 mm 100 mm	1 TAHBE-8040
5.5 mm 150 mm	1 TAHBE-8241
6.5 mm 150 mm	1 TAHBE-8252

ERGO™ Slotted Screwdrivers with Dyneema String



TAHBE8155



6 mm 125 mm	1 TAHBE-8155
8 mm 175 mm	1 TAHBE-8257
10 mm 210 mm	1 TAHBE-8258

ERGO™ Bolster Screwdrivers for Slotted Head Screws with Dyneema String



TAHBE-8260



9 mm 175 mm	1 TAHBE-8260
12 mm 200 mm	1 TAHBE-8880

ERGO™ Stubby Screwdrivers for Slotted Head Screws with Safety Chuck



TAHBE-8350



5.5 mm 28 mm	1 TAHBE-8350

ERGO™ Screwdrivers for Phillips Head Screws with Safety Chuck



TAHBE8610-TAHBE8624



PH 1 75 mm	1 TAHBE-8611
PH 1 75 mm	1 TAHBE-8610
PH 2 100 mm	1 TAHBE-8620
PH 2 200 mm	1 TAHBE-8620L
PH 3 150 mm	1 TAHBE-8623
PH 4 190 mm	1 TAHBE-8624

ERGO™ Bolster Screwdrivers for Phillips Head Screws with Dyneema String



TAHBE-8630



PH 3 155 mm	1 TAHBE-8630

ERGO™ Stubby Screwdrivers for Phillips Head Screws with Safety Chuck



TAHBE-8602



PH2 30 mm	1 TAHBE-8602

ERGO™ Screwdrivers for Pozidriv Head Screws with Safety Chuck



TAHBE8810-TAHBE8820



PZ 1	73 mm	1	TAHBE-8810
PZ 2	100 mm	1	TAHBE-8820

ERGO™ Insulated Slotted Screwdrivers with Kevlar String



TAHBE8040S-TAHBE8050S



3.0 mm	100 mm	1	TAHBE-8220S
4.0 mm	100 mm	1	TAHBE-8040S
5.5 mm	125 mm	1	TAHBE-8050S
6.5 mm	155 mm	1	TAHBE-8255S

ERGO™ Slim VDE Insulated Pozidriv Screwdrivers with 3-Component Handle with Kevlar Cord



TAHBE-8820SL



PZ 2	PZ 2	1	TAHBE-8820SL

ERGO™ Bolster Screwdrivers for Pozidriv Head Screws with Dyneema String



TAHBE-8830



PZ 3	150 mm	1	TAHBE-8830

ERGO™ Insulated Phillips Screwdrivers with Kevlar String



TAHBE8610S-TAHBE8620S



PH1	80 mm	1	TAHBE-8610S
PH2	100 mm	1	TAHBE-8620S
PH3	150 mm	1	TAHBE-8630S
PH4	190 mm	1	TAHBE-8640S

Slotted Screwdrivers with Precision Grip 0.18–0.8 mm with Stainless Steel Ring



TAH700



1.5 mm	137 mm	1	TAH700-1.5-50
1.8 mm	137 mm	1	TAH700-1.8-50
2.5 mm	137 mm	1	TAH700-2.5-50
3 mm	187 mm	1	TAH700-3-100

ERGO™ Screwdrivers for TORX® Head Screws with Safety Chuck



TAHBE8910-TAHBE8930



T10	2.72 mm	1	TAHBE-8910
T15	3.26 mm	1	TAHBE-8915
T20	3.84 mm	1	TAHBE-8920
T25	4 mm	1	TAHBE-8925
T30	6 mm	1	TAHBE-8930

ERGO™ Insulated TORX® Head Screwdrivers with Kevlar String



TAHBE8910S-TAHBE8930S



T10	2.5 mm	1	TAHBE-8910S
T15	3.26 mm	1	TAHBE-8915S
T20	3.84 mm	1	TAHBE-8920S
T25	4.4 mm	1	TAHBE-8925S
T30	5.49 mm	1	TAHBE-8930S

Phillips Screwdrivers with Precision Grip PH00-PH1 with Stainless Steel Ring



TAH701



PH00	137 mm	1	TAH701-00-50
PH 0	137 mm	1	TAH701-0-50



Torx® Screwdrivers with Precision Grip T4-T20 with Stainless Steel Ring



TAH703



Size	Length	Qty	Part No.
T 6	137 mm	1	TAH703-6-50
T 7	137 mm	1	TAH703-7-50
T 8	137 mm	1	TAH703-8-50
T 9	137 mm	1	TAH703-9-50
T 10	137 mm	1	TAH703-10-50
T 15	162 mm	1	TAH703-15-75

Metric Hex Folding L-Key Set with Phosphate Finish 1.5–6 mm - 7 pcs with Kevlar Textile Wire Loop



TAHBE-9776



Size	Length	Qty	Part No.
1.5, 2, 2.5, 3, 4, 5, 6 mm		1	TAHBE-9776

Double Offset Keys for Slotted Screws with Steel Wire



TAH2047



Size	Length	Qty	Part No.
4.0 mm	100 mm	1	TAH2047-0.8-4

Metric Hex L-Keys with Phosphate Finish with Stainless Steel Ring



TAH1995M



Size	Length	Qty	Part No.
8 mm	108 mm	1	TAH1995M-8
10 mm	122 mm	1	TAH1995M-10
12 mm	137 mm	1	TAH1995M-12

Metric Offset Screwdriver Hex Key Folders with Kevlar String - 7 Pcs



TAHBE-9777B



Size	Length	Qty	Part No.
2.5, 3, 4, 5, 6, 8, 10 mm		1	TAHBE-9777B

Double Offset Keys for Phillips Screws with Steel Wire



TAH2047PR



Size	Length	Qty	Part No.
PH 1 & 2	100 mm	1	TAH2047PR-1-2

Imperial Hex L-Keys with Phosphate Finish with Stainless Steel Ring



TAH1995Z



Size	Length	Qty	Part No.
1/2 in	145 mm	1	TAH1995Z-1/2

Imperial Offset Screwdriver Hex Key Folders with Insert Plate - 7 Pcs



TAHBE-9787



Size	Length	Qty	Part No.
3/32, 1/8, 5/32, 3/16, 1/4, 5/16, 3/8 in		1	TAHBE-9787

PLIERS

ERGO™ Side Cutting Pliers with Safety Ring



TAH2101G



Length	Qty	Part No.
130 mm	1	TAH2101G-125
145 mm	1	TAH2101G-140
165 mm	1	TAH2101G-160
185 mm	1	TAH2101G-180
125 mm	1	TAH2101G-125C
145 mm	1	TAH2101G-140C
165 mm	1	TAH2101G-160C
180 mm	1	TAH2101G-180C

ERGO™ Heavy Duty Side Cutting Pliers with Safety Ring



ergo



TAH21HDG

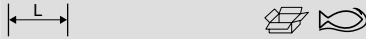

210 mm	1	TAH21HDG-200
200 mm	1	TAH21HDG-200C

ERGO™ Snipe Nose Pliers with Safety Ring



ergo



TAH2430G

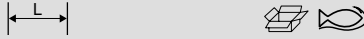

160 mm	1	TAH2430G-160
200 mm	1	TAH2430G-200

Ratcheting Crimping Pliers for Insulated Connectors with Fixed Metallic Wire Loop



TAHCRW01

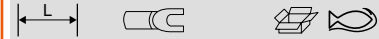

225 mm	0.5-6.0 mm ²	1	TAHCRW01
--------	-------------------------	---	----------

ERGO™ Combination Pliers with Safety Ring



ergo



TAH2628G

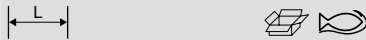

170 mm	1	TAH2628G-160
190 mm	1	TAH2628G-180
200 mm	1	TAH2628G-200

ERGO™ Snipe Nose Pliers with 45° Bent Tips and Safety Ring



ergo



TAH2427G

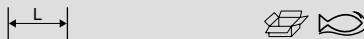

200 mm	1	TAH2427G-200
--------	---	--------------

Internal Circlip Pliers with Straight Jaws and Phosphate Finish with Stainless Steel Ring



TAH2800

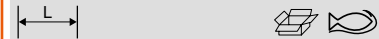

150 mm	1	TAH2800-150
180 mm	1	TAH2800-180

2 Position Combination Pliers with Safety Ring



TAH2970G

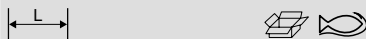

200 mm	1	TAH2970G-200
--------	---	--------------

ERGO™ Wire Stripping Pliers with Safety Ring



ergo



TAH2223G-150

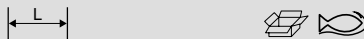

167 mm	1	TAH2223G-150
--------	---	--------------

External Circlip Pliers with Straight Jaws and Phosphate Finish with Stainless Steel Ring



TAH2900

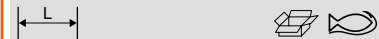

180 mm	1	TAH2900-180
--------	---	-------------



TAH Universal grip with curved jaws. 0



TAH2951



235 m

1 TAH2951-250

Self Grip Locking Pliers with Curved Jaws with Fixed Metallic Plate



TAH2953



140 mm
300 mm

1 TAH2953-140
1 TAH2953-300

Grips with Straight Jaws and Insert Plate



TAH2958



200 mm
245 mm

1 TAH2958-200
1 TAH2958-250

ERGO™ Water Pump Pliers with Safety Ring



ergo



TAH8224



250 mm

1 TAH8224

High Leverage Fencing Pliers with Black Epoxy Finish and Safety Ring



TAH2339



2.5 mm

250 mm

1 TAH2339-250

CUTTING TOOLS

Folding Pruning Saws with Dual-Component Handle with Sealed Dyneema Cord



TAH396



190 mm

7 1/2 in

1 TAH396-JT

ERGO™ Professional Hand Hacksaw Frames with Loop Wire



ergo



TAH325



300 mm

1 TAH325

Traditional Hand Hacksaw Frames with Loop Wire



TAH320



500 mm

1 TAH320

Hacksaw Frames with Loop Wire for All Round Use



TAH317

432 mm		1	TAH317

Aluminium Hand Hacksaw Frames with Loop Wire



TAH225

310 mm		1	TAH225-PLUS

ERGO™ Flat Files with Safety Ring



ergo



TAH1-100

265 mm	2	1	TAH1-100-06-2-4

ERGO™ Engineering Tapered Edge Flat Files Bastard/Second/Smooth Cut with Permanent Stainless Steel Ring



ergo



TAH1-110

200 mm	1	1	TAH1-110-08-1-2

ERGO™ Mill Files with 2 Flat Edges and Safety Ring



ergo



TAH1-143

415 mm	1	1	TAH1-143-12-1-2

ERGO™ Engineering Square Files Bastard/Second/Smooth Cut with Permanent Stainless Steel Ring



ergo



TAH1-160

200 mm	1	1	TAH1-160-08-1-2

ERGO™ Engineering 3 Square Files Bastard/Second/Smooth Cut with Permanent Stainless Steel Ring



ergo



TAH1-170

200 mm	1	1	TAH1-170-08-1-2

ERGO™ Half-Round Files with Safety Ring



ergo



TAH1-210

270 mm	2	1	TAH1-210-06-2-2
325 mm	1	1	TAH1-210-08-1-2

ERGO™ Round Files with Safety Chuck



ergo



TAH1-230

260 mm	2	1	TAH1-230-06-2-2
310 mm	1	1	TAH1-230-08-1-2

Heavy Duty Electrician Scissors with Wire Loop



TAHSCB140G

145 mm	43 mm	1	TAHSCB140G

Electrician Knives with Dyneema String



TAH2820EF

195 mm	85 mm	1	TAH2820EF2



Utility Wire Brushes With Wooden Handle



TAH52-TAH782-U



L	Weight	Part No.
150 mm	1	TAH52
290 mm	1	TAH782-U

Ball Pein Hammers with Wire Loop and Hickory Handle



TAH479



Weight	L	Part No.
480 g	350 mm	1 TAH479-16
900 g	400 mm	1 TAH479-32

Safety Sledge Hammers with Wire Loop



TAH489



Weight	L	Part No.
1100 g	294 mm	1 TAH489-1100
1800 g	300 mm	1 TAH489-1800
2700 g	770 mm	1 TAH489-2700
3600 g	770 mm	1 TAH489-3600
4500 g	797 mm	1 TAH489-4500
5400 g	795 mm	1 TAH489-5400

HAMMERS, PRY BARS & CHISELS

Dead Blow Sledge Hammers with Wire Loop and Anti-Sliding Handle



TAH3625PU



Weight	L	Part No.
620 g	340 mm	1 TAH3625PU-50

German DIN Hammers with Wire Loop



TAH481



Weight	L	Part No.
300 g	300 mm	1 TAH481-300

Ball Pein Hammers with Unbreakable Handle and Fixed Metallic Wire Loop



TAH490



Weight	L	Part No.
700 g	340 mm	1 TAH490-700
900 g	340 mm	1 TAH490-900
1100 g	340 mm	1 TAH490-1100

Nylon Tip Mallets with Wire Loop



TAH3625PW



L	Part No.
300 mm	1 TAH3625W-35

Club Hammers with Wire Loop and Hickory Handle



TAH484



Weight	L	Part No.
1000 g	260 mm	1 TAH484-1000
1500 g	280 mm	1 TAH484-1500
2000 g	305 mm	1 TAH484-2000

Spanish Type Bricklayer Hammers with Wire Loop



TAH486F



Weight	L	Part No.
700 g	330 mm	1 TAH486F-700

Carpenter's Hammer Spike Claw with Tubular Steel Shaft with Wire Loop



TAH485



600 g	318 mm	1 TAH485

Bi-Material Parallel Punches with Safety Chuck



TAH3734BM



155 mm	2 mm	1 TAH3734BM-2
155 mm	3 mm	1 TAH3734BM-3
165 mm	4 mm	1 TAH3734BM-4
165 mm	5 mm	1 TAH3734BM-5
185 mm	6 mm	1 TAH3734BM-6
185 mm	8 mm	1 TAH3734BM-8
185 mm	10 mm	1 TAH3734BM-10

Pointed Chisels with Octagonal Shank and Lacquered Copper Finish with Fixed Metallic Wire Loop



TAH3739



300 mm	1 TAH3739-300

Non-Sparking and Anti-Magnetic Hammers with Aluminium Bronze Shackle



TAH487



4500 g	895 mm	1 TAH487-5200

Bi-Material Centre Punches with Safety Chuck



TAH3755BM



165 mm	4 mm	1 TAH3755BM-4

Pry Bars with PVC Handle and Safety Ring



TAH2484



305 mm	1 TAH2484-30

TAH Special steel hexagonal bar



TAHWBB



595 mm	1 TAHWBB600
680 mm	1 TAHWBB700

Cold Chisels with Safety Ring



TAH3640



250 mm	1 TAH3640-250-C

Cam Pry Bars with Bow Shackle



TAH3683



400 mm	1 TAH3683



Rolling Head Pry Bars with Phosphated Body with Fixed Metallic Wire Loop



TAH3681



304 mm	1	TAH3681-11
406 mm	1	TAH3681-16
503 mm	1	TAH3681-20

Scaffold Levels with Dyneema String



TAH466



250 mm	1	TAH466-250
--------	---	------------

Squares with Dyneema String



TAH9045-B-250



250 mm	170 mm	1	TAH9045-B-250
--------	--------	---	---------------

MEASURING & LAYOUT

Long Measuring Tapes with Nylon Coated Blade and Open Case with Dyneema Textile Wire Loop



TAHLTS



30 m	13 mm	1	TAHLTS-30
------	-------	---	-----------

Combination Squares with Dyneema String



TAHCS300



300 mm	125 mm	1	TAHCS300
--------	--------	---	----------

Callipers with Safety Ring



TAH1150



7 x 75 x 235 mm	1	TAH1150-1/2H/P
-----------------	---	----------------

Metric Stainless Steel Rulers with Dyneema Textile Wire Loop



TAHSR300



300 mm	1	TAHSR300-MM
--------	---	-------------

Carpenter Squares with Dyneema String



TAH9048-250



250 mm	165 mm	1	TAH9048-250
--------	--------	---	-------------

Offset Scribes with Wire Loop



TAH1177



30 g	1	TAH1177-SCRIBE
------	---	----------------

Professional Feeler Gauges with Safety Ring



TAH1544



105 mm

1 TAH1544

TORQUE TOOLS

Mechanical Adjustable Torque Click Wrench with Marked Scale and Fixed Ratchet Head with Metallic Plate



TAH73R



1/2" 20-100 N·m
1/2" 40-200 N·m
1/2" 60-300 N·m

1 TAH73R-100
1 TAH73R-200
1 TAH73R-300

Torque Wrenches with Fixed Ratchet Head and Wire Loop



TAH7445



20-100 N·m 1/2 in

1 TAH7445-100A-1

Mechanical Torque Wrenches with Wire Loop



TAH7455



60-300 N·m 44.3-221.3 lbf·ft 1 TAH7455-300-1

Torque Wrenches with Interchangeable Head and Wire Loop



TAH74W9



20-100 N·m 9x12 mm 1 TAH74W9-100

Reversible Ratchet Head Inserts with Locking Device



TAH7452-2

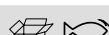

9x12 mm 1/2" 1 TAH7452-2

Reversible Ratchet Insert Tools with Safety Pin Locking Mechanism



TAH7852-1



14X18 mm 1/2" 1 TAH7852-1

CLAMPING TOOLS

F-Clamps with Safety Bow Shackle



TAH420SH-80-160



160 mm 80 mm 1 TAH420SH-80-160

OTHER TOOLS

Carbon Scrapers with Safety Spring



TAH2487



205 mm 1 TAH2487



Miniature Awls/Hooks/Picks Tool Set with Kevlar Textile Wire Loop



TAH2633



146 g



1 TAH2633/S4

Flexible Pick-up Tools with Wire Loop



TAH2509



560 mm



1 TAH2509

ERGO™ Magnetic Pick-ups with Dyneema String



TAH2535F2



13 mm



405 mm



1 TAH2535F2

Chain Oil Filter Wrenches with D-shackle



TAHBE64520



520 mm



60-160 mm



1 TAHBE64520

Head Torches with Dyneema String



TAHBFRL11



90 x 95 x 115 mm



1 TAHBFRL11

Grease Pumps with Quick Link



TAHBOD54



120 x 385 x 57 mm

135 x 400 x 61 mm



1 TAHBOD5400

1 TAHBOD5450

GLOVES

General Purpose Gloves with Absorption Pad



GL008



8
10



5 GL008-8
5 GL008-10

General Purpose Synthetic Leather Gloves



3875-GLOVE



9



67 g



5 3875-GLOVE

Power Tool Gloves with Absorption Pad and Anti-Vibration Pad



GL010



8
10



5 GL010-8
5 GL010-10



Insulated Tools



SCREWDRIVERS

ERGO™ VDE Insulated Slotted Screwdrivers with 3-Component Handle 2.5 mm-12 mm



BE-8010S - BE-8065S

Tip Size	Length	Quantity	Part No.
2.5 mm	75 mm	5	BE-8010S
3.0 mm	100 mm	5	BE-8220S
3.5 mm	100 mm	5	BE-8230S
4.0 mm	100 mm	5	BE-8040S
5.5 mm	125 mm	5	BE-8050S
6.5 mm	150 mm	5	BE-8255S
8.0 mm	175 mm	5	BE-8065S
10 mm	200 mm	5	BE-8258S
12 mm	200 mm	5	BE-8259S

ERGO™ VDE Insulated Phillips Screwdrivers with 3-Component Handle PH0-PH4



BE-8600S - BE-8640S

Tip Size	Length	Quantity	Part No.
PH 0	75 mm	5	BE-8600S
PH 1	80 mm	5	BE-8610S
PH1	80 mm	5	BE-8611S
PH 1	150 mm	5	BE-8612S
PH 2	100 mm	5	BE-8620S
PH 2	100 mm	5	BE-8621S
PH 2	175 mm	5	BE-8622S
PH 3	150 mm	5	BE-8630S
PH 4	200 mm	5	BE-8640S

ERGO™ VDE Insulated Pozidriv Screwdrivers with 3-Component Handle PZ0-PZ4



BE-8800S - BE-8840S

Tip Size	Length	Quantity	Part No.
PZ 0	75 mm	5	BE-8800S
PZ 1	80 mm	5	BE-8810S
PZ1	80 mm	5	BE-8811S
PZ 1	150 mm	5	BE-8812S
PZ 2	100 mm	5	BE-8820S
PZ 2	100 mm	5	BE-8821S
PZ 2	175 mm	5	BE-8822S
PZ 3	150 mm	5	BE-8830S
PZ 4	200 mm	5	BE-8840S

ERGO™ VDE Insulated TORX® Head Screwdrivers with 3-Component Handle T5-T30



BE-8910S - BE-8930S

Tip Size	Length	Quantity	Part No.
T 5	75 mm	5	BE-8905S
T 6	75 mm	5	BE-8906S
T 7	75 mm	5	BE-8907S
T 8	75 mm	5	BE-8908S
T 9	75 mm	5	BE-8909S
T 10	100 mm	5	BE-8910S
T 15	125 mm	5	BE-8915S
T 20	125 mm	5	BE-8920S
T 25	150 mm	5	BE-8925S
T 30	175 mm	5	BE-8930S

ERGO™ VDE Insulated Hex Socket-Head Screwdrivers with 3-Component Handle 2.5 mm-8 mm



BE-8725S - BE-8708S

Tip Size	Length	Quantity	Part No.
2.5 mm	100 mm	5	BE-8725S
3 mm	125 mm	5	BE-8703S
4 mm	150 mm	5	BE-8704S
5 mm	175 mm	5	BE-8705S
6 mm	150 mm	5	BE-8706S
8 mm	200 mm	5	BE-8708S

ERGO™ VDE Insulated Plus-Minus/Phillips-Tip Screwdrivers with 3-Component Handle 5.0/PH1-6.0/PH2



BE-8510S - BE-8520S

Tip Size	Length	Quantity	Part No.
5.0/PH1	80 mm	5	BE-8510S
6.0/PH2	100 mm	5	BE-8520S

ERGO™ VDE Insulated Plus-Minus/Pozidriv-Tip Screwdrivers with 3-Component Handle 5.0/PZ1-6.0/PZ2



BE-8710S - BE-8720S

Tip Size	Length	Quantity	Part No.
5.0/PZ1	80 mm	5	BE-8710S
6.0/PZ2	100 mm	5	BE-8720S

ERGO™ VDE Insulated Nut Drivers with 3-Component Handle 5.5 mm-10 mm



BE-7855S - BE-7810S

Tip Size	Length	Quantity	Part No.
5.5 mm	125 mm	5	BE-7855S
6 mm	125 mm	5	BE-7806S
7 mm	125 mm	5	BE-7807S
8 mm	125 mm	5	BE-7808S
9 mm	125 mm	5	BE-7809S
10 mm	125 mm	5	BE-7810S

ERGO™ VDE Insulated Plus-Minus/
Pozidriv-Tip Screwdriver Set with
3-Component Handle - 2 Pcs



ergo



BE-9890S

2 175 g 1 BE-9890S

BE-8710S, BE-8720S

ERGO™ VDE Insulated Slotted and
Phillips Screwdriver Set with 3-Component
Handle - 5 Pcs



ergo



BE-9881S

5 1 BE-9881S

BE-8220S, BE-8040S, BE-8050S

BE-8611S, BE-8621S

ERGO™ VDE Insulated Slotted
and Pozidriv Screwdriver Set with
3-Component Handle - 5 Pcs



ergo



BE-9882S

5 1 BE-9882S

BE-8220S, BE-8050S, BE-8040S

BE-8811S, BE-8821S

ERGO™ VDE Insulated Plus-Minus/
Phillips, Plus-Minus/Pozidriv-Tip
Screwdriver Set with 3-Component Handle
and 150 V-250 V voltage tester - 5 Pcs



ergo



BE-9885S

5 1 BE-9885S

806-1-1

BE-8520S, BE-8510S

BE-8710S, BE-8720S

ERGO™ VDE Insulated Slotted, Pozidriv
and Plus-Minus/Pozidriv-Tip Screwdriver
Set with 3-Component Handle - 6 Pcs



ergo



BE-9884S

6 1 BE-9884S

BE-8220S, BE-8040S

BE-8710S, BE-8720S

BE-8810S, BE-8820S

ERGO™ VDE Insulated Slotted and
Phillips Screwdriver Set with 3-Component
Handle - 7 Pcs



ergo



BE-9887S

7 1 BE-9887S

806-1-1

BE-8010S, BE-8050S, BE-8230S,
BE-8040S

BE-8611S, BE-8621S

ERGO™ VDE Insulated Slotted
and Pozidriv Screwdriver Set with
3-Component Handle - 7 Pcs



ergo



BE-9889S

7 1 BE-9889S

BE-8010S, BE-8040S, BE-8050S,
BE-8230S

BE-8821S, BE-8811S

806-1-1



ERGO™ Slotted, Phillips, Pozidriv, TORX® and Plus-Minus/Pozidriv Screwdriver Set with Rubber Grip - 14 Pcs



ergo



BE-9876S



14

1 BE-9876S

BE-8010S, BE-8220S, BE-8230S, BE-8040S, BE-8050S



BE-8611S, BE-8621S



BE-8811S, BE-8821S



BE-8910S, BE-8915S, BE-8920S



BE-8710S, BE-8720S



ERGO™ Slim VDE Insulated Slotted Screwdrivers with 3-Component Handle 3.0 mm-6.5 mm



ergo



BE-8220SL - BE-8255SL

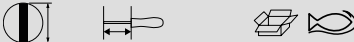

3.0 mm 100 mm 10 BE-8220SL

3.5 mm 100 mm 10 BE-8230SL

4.0 mm 100 mm 10 BE-8040SL

5.5 mm 125 mm 10 BE-8050SL

6.5 mm 150 mm 10 BE-8255SL

ERGO™ Slim VDE Insulated Phillips Screwdrivers with 3-Component Handle PH1-PH2



ergo



BE-8610SL - BE-8620SL

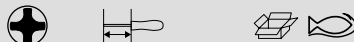

PH 1 80 mm 10 BE-8610SL

PH 2 100 mm 10 BE-8620SL

ERGO™ Slim VDE Insulated Pozidriv Screwdrivers with 3-Component Handle PZ1-PZ2



ergo



BE-8810SL - BE-8820SL



PZ 1 80 mm 10 BE-8810SL

PZ 2 100 mm 10 BE-8820SL

ERGO™ Slim VDE Insulated TORX® Screwdrivers with 3-Component Handle T10-T30



ergo



BE-8910SL - BE-8930SL



T 10 100 mm 5 BE-8910SL

T 15 100 mm 5 BE-8915SL

T 20 100 mm 5 BE-8920SL

T 25 125 mm 5 BE-8925SL

T 30 150 mm 5 BE-8930SL

ERGO™ Slim VDE Insulated Plus-Minus/Phillips-Tip Screwdrivers with 3-Component Handle for 5.0/PH1 - 6.0/PH2



ergo



BE-8510SL - BE-8520SL



5.0/PH1 80 mm 10 BE-8510SL

6.0/PH2 100 mm 10 BE-8520SL

ERGO™ Slim VDE Insulated Plus-Minus/Pozidriv-Tip Screwdrivers with 3-Component Handle 5.0/PZ1 - 6.0/PZ2



ergo



BE-8710SL - BE-8720SL



5.0/PZ1 80 mm 10 BE-8710SL

6.0/PZ2 100 mm 10 BE-8720SL

ERGO™ Slim VDE Insulated Plus-Minus/Pozidriv Screwdriver Set with 3-Component Handle - 2 Pcs



ergo



BE-9890SL



2 175 g 1 BE-9890SL

BE-8710SL, BE-8720SL

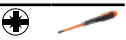

ERGO™ Slim VDE Insulated Phillips Screwdriver Set with 3-Component Handle - 2 Pcs



ergo



BE-9891SL



2 132 g 1 BE-9891SL

BE-8610SL, BE-8620SL

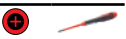

ERGO™ Slim VDE Insulated Pozidriv Screwdriver Set with 3-Component Handle - 2 Pcs



ergo

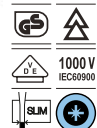

BE-9894SL

2	132 g	1	BE-9894SL

BE-8810SL, BE-8820SL	
----------------------	--

ERGO™ Slim VDE Insulated TORX® Screwdriver Set with 3-Component Handle - 4 Pcs



ergo



BE-9880SL

4	1	BE-9880SL

BE-8910SL, BE-8915SL, BE-8920SL, BE-8925SL	
--	--

ERGO™ Slim VDE Insulated Slotted and Phillips Screwdriver Set with 3-Component Handle - 5 Pcs



ergo



BE-9881SL

5	1	BE-9881SL

BE-8220SL, BE-8040SL, BE-8050SL	
BE-8610SL, BE-8620SL	

ERGO™ Slim VDE Insulated Slotted and Pozidriv Screwdriver Set with 3-Component Handle - 5 Pcs



ergo



BE-9882SL

5	1	BE-9882SL

BE-8220SL, BE-8040SL, BE-8050SL	
BE-8810SL, BE-8820SL	

ERGO™ Slim VDE Insulated Slotted, Phillips and Torx® Screwdriver Set with 3-Component Handle - 5 pcs



ergo

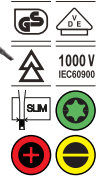

BE-9871SL

5	1	BE-9871SL

BE-8220SL, BE-8040SL	
BE-8910SL	
BE-8610SL, BE-8620SL	

ERGO™ Slim VDE Insulated Slotted, Pozidriv and Torx® Screwdriver Set with 3-Component Handle - 5 pcs



ergo

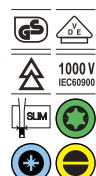

BE-9872SL

5	1	BE-9872SL

BE-8220SL, BE-8040SL	
BE-8910SL	
BE-8810SL, BE-8820SL	

ERGO™ Slim VDE Insulated Slotted, Phillips, Pozidriv, Torx and Plus-Minus/ Phillips Screwdriver Set with 3-Component Handle - 12 Pcs



ergo



BE-9878SL

12	1	BE-9878SL

BE-8010S	
BE-8220SL, BE-8230SL, BE-8040SL, BE-8050SL	
BE-8610SL, BE-8620SL	
BE-8810SL, BE-8820SL	
BE-8510SL, BE-8520SL	
BE-8910SL	

BahcoFit VDE Insulated Slotted Screwdrivers with Multi-Component Handle 2.5 mm-12 mm



B196

2.5 mm	75 mm	10	B196.025.075
3 mm	100 mm	10	B196.030.100
3.5 mm	100 mm	10	B196.035.100
4 mm	100 mm	10	B196.040.100
5.5 mm	125 mm	10	B196.055.125
6.5 mm	150 mm	10	B196.065.150
8 mm	175 mm	10	B196.080.175
10 mm	200 mm	10	B196.100.200
12 mm	200 mm	10	B196.120.200
2.5 mm	75 mm	1	SB196.025.075
3 mm	100 mm	1	SB196.030.100
3.5 mm	100 mm	1	SB196.035.100
4 mm	100 mm	1	SB196.040.100
5.5 mm	125 mm	1	SB196.055.125
6.5 mm	150 mm	1	SB196.065.150
8 mm	175 mm	1	SB196.080.175
10 mm	200 mm	1	SB196.100.200
12 mm	200 mm	1	SB196.120.200



BahcoFit VDE Insulated Phillips Screwdrivers with Multi-Component Handle PH0-PH4



B197PH

Tip	Length	Qty	Part No.
PH0	75 mm	10	B197.000.075
PH1	80 mm	10	B197.001.080
PH1	150 mm	10	B197.001.150
PH2	100 mm	10	B197.002.100
PH2	175 mm	10	B197.002.175
PH3	150 mm	10	B197.003.150
PH4	200 mm	10	B197.004.200
PH0	75 mm	1	SB197.000.075
PH1	80 mm	1	SB197.001.080
PH2	100 mm	1	SB197.002.100
PH3	150 mm	1	SB197.003.150
PH4	200 mm	1	SB197.004.200

BahcoFit VDE Insulated Pozidriv Screwdrivers with Multi-Component Handle PZ0-PZ3



B142PZ

Tip	Length	Qty	Part No.
PZ0	75 mm	10	B142.000.075
PZ1	80 mm	10	B142.001.080
PZ1	150 mm	10	B142.001.150
PZ2	100 mm	10	B142.002.100
PZ2	175 mm	10	B142.002.175
PZ3	150 mm	10	B142.003.150
PZ0	75 mm	1	SB142.000.075
PZ1	80 mm	1	SB142.001.080
PZ2	100 mm	1	SB142.002.100
PZ3	150 mm	1	SB142.003.150

BahcoFit VDE Insulated TORX® Screwdrivers with Multi-Component Handle T10-T25



B150TORX

Tip	Length	Qty	Part No.
T10	100 mm	10	B150.010.100
T15	125 mm	10	B150.015.125
T20	125 mm	10	B150.020.125

Tip	Length	Qty	Part No.
T25	150 mm	10	B150.025.150
T10	100 mm	1	SB150.010.100
T15	125 mm	1	SB150.015.125
T20	125 mm	1	SB150.020.125
T25	150 mm	1	SB150.025.150

BahcoFit VDE Insulated Plus-Minus/Phillips-Tip Screwdrivers with Multi-Component Handle 5.0/PH1 - 6.0/PH2



B148

Tip	Length	Qty	Part No.
5.0mm/PH1	80 mm	10	B148.001.080
6.0mm/PH2	100 mm	10	B148.002.100
5.0mm/PH1	80 mm	1	SB148.001.080
6.0mm/PH2	100 mm	1	SB148.002.100

BahcoFit VDE Insulated Nut Drivers with Multi-Component Handle 5.5 mm-13 mm



B199

Tip	Length	Qty	Part No.
5.5 mm	125 mm	5	B199.055.125
6 mm	125 mm	5	B199.060.125
7 mm	125 mm	5	B199.070.125
8 mm	125 mm	5	B199.080.125
9 mm	125 mm	5	B199.090.125
10 mm	125 mm	5	B199.100.125
11 mm	125 mm	5	B199.110.125
12 mm	125 mm	5	B199.120.125
13 mm	125 mm	5	B199.130.125
5.5 mm	125 mm	1	SB199.055.125
6 mm	125 mm	1	SB199.060.125
7 mm	125 mm	1	SB199.070.125
8 mm	125 mm	1	SB199.080.125
9 mm	125 mm	1	SB199.090.125
10 mm	125 mm	1	SB199.100.125
11 mm	125 mm	1	SB199.110.125
12 mm	125 mm	1	SB199.120.125
13 mm	125 mm	1	SB199.130.125

BahcoFit VDE Insulated Plus-Minus/Pozidriv-Tip Screwdrivers with Multi-Component Handle 5.0/PZ1-6.0/PZ2



B149

Tip	Length	Qty	Part No.
5.0mm/PZ1	80 mm	10	B149.001.080
6.0mm/PZ2	100 mm	10	B149.002.100
5.0mm/PZ1	80 mm	1	SB149.001.080
6.0mm/PZ2	100 mm	1	SB149.002.100

BahcoFit VDE Insulated Slotted and Phillips Screwdriver Set with Multi-Component Handle - 2 Pcs



B220.002

Tip	Length	Qty	Part No.
X	g	1	B220.002

B196.030.100

B197.001.080

BahcoFit VDE Insulated Plus-Minus/Pozidriv-Tip Screwdriver Set with Multi-Component Handle - 2 Pcs



B220.012

Tip	Length	Qty	Part No.
X	g	1	B220.012

B149.001.080, B149.002.100

BahcoFit VDE Insulated Slotted and Phillips Screwdriver Set with Multi-Component Handle - 5 Pcs



B220.005



5 1 B220.005

B196.030.100, B196.040.100,
B196.055.125



B197.001.080, B197.002.100



BahcoFit VDE Insulated Slotted and Pozidriv Screwdriver Set with Multi-Component Handle - 5 Pcs



B220.015



5 1 B220.015

B196.035.100, B196.040.100,
B196.065.150



B142.001.080, B142.002.100



BahcoFit VDE Insulated Slotted and Phillips Screwdriver Set with Multi-Component Handle - 7 Pcs



B220.007



7 1 B220.007

B196.030.100, B196.040.100,
B196.055.125, B196.065.150



B197.000.075, B197.001.080,
B197.002.100



BahcoFit VDE Insulated Slotted and Pozidriv Screwdriver Set with Multi-Component Handle - 7 Pcs



B220.017



7 1 B220.017

B196.025.075, B196.040.100,
B196.055.125, B196.065.150



B142.000.075, B142.001.080,
B142.002.100



BahcoFit VDE Insulated Slotted and Phillips Screwdriver Set with Multi-Component Handle and 150 V-250 V Voltage Tester - 7 Pcs



B220.027



7 1 B220.027

B196.030.100, B196.040.100,
B196.055.125



B197.000.075, B197.001.080,
B197.002.100



806-1-1



VDE Insulated Slotted Screwdrivers with Multi-Component Handle 3.0 mm-6.5 mm



623



3.0 mm	100 mm	10	623-3-100
3.5 mm	100 mm	10	623-3.5-100
4.0 mm	100 mm	10	623-4-100
5.5 mm	125 mm	10	623-5.5-125
6.5 mm	150 mm	10	623-6.5-150

VDE Insulated Phillips Screwdrivers with Multi-Component Handle PH0-PH2



625PH



PH 0	100 mm	10	625-0-100
PH 1	150 mm	10	625-1-150
PH 2	175 mm	10	625-2-175

VDE Insulated Slotted and Phillips Screwdriver Set with Multi-Component Handle - 6 Pcs



620-6



6 1 620-6

623-4-100, 623-3-100, 623-5.5-125,
623-6.5-150



625-1-150, 625-2-175

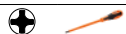

Insulated Ratcheting Screwdriver with Slotted and Phillips Interchangeable Blades Set - 6 Pcs

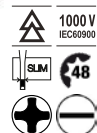

808061

7	85 x 85 x 218 mm	5	808061

Pouch contains 6 individual blades

808060		
8610SL-2P, 8620SL-2P		
8010SL-2P, 8050SL-2P, 8220SL-2P, 8040SL-2P		

Insulated Ratcheting Screwdriver with Slotted and Pozidriv Interchangeable Blades Set - 6 Pcs



808062

7	85 x 85 x 215 mm	5	808062

Pouch contains 6 individual blades

808060		
8820SL-2P, 8810SL-2P		
8010SL-2P, 8050SL-2P, 8220SL-2P, 8040SL-2P		

Insulated Ratcheting Screwdriver with Dual-Component Handle



808060

36 mm	122 mm	1	808060

Insulated Slotted Interchangeable Blades with Reduced Diameter



8010SL-2P - 8050SL-2P

0.4 mm	2.5 mm	1	8010SL-2P
0.5 mm	3.0 mm	1	8220SL-2P
0.8 mm	4.0 mm	1	8040SL-2P
1.0 mm	5.5 mm	1	8050SL-2P

Insulated Phillips and Pozidriv Interchangeable Blades with Reduced Diameter PH1, PZ1



8610SL-2P - 8620SL-2P

1		1	8610SL-2P
2		1	8620SL-2P

Insulated Phillips and Pozidriv Interchangeable Blades with Reduced Diameter PH2, PZ2



8810SL-2P - 8820SL-2P

1		1	8810SL-2P
2		1	8820SL-2P

Insulated Plus-Minus/Phillips-Tip Interchangeable Blades with Reduced Diameter



8510SL-2P - 8520SL-2P

5.0/PH1		1	8510SL-2P
6.0/PH2		1	8520SL-2P

Insulated Combi-Tip Slotted and Pozidriv Interchangeable Blades with Reduced Diameter



8710SL-2P - 8720SL-2P

5.0/PZ1		1	8710SL-2P
6.0/PZ2		1	8720SL-2P

Insulated TORX® Interchangeable Blades with Reduced Diameter



8910SL-2P - 8930SL-2P

10		1	8910SL-2P
15		1	8915SL-2P
20		1	8920SL-2P
25		1	8925SL-2P
30		1	8930SL-2P

PLIERS

ERGO™ Side Cutting Pliers with Insulated Handles and Phosphate Finish



2101S

3.7 mm	2.0 mm	3	2101S-140
3.8 mm	2.5 mm	3	2101S-160
4.0 mm	2.7 mm	3	2101S-180

ERGO™ Side Cutting Pliers with Insulated Handles and Phosphate Finish 200 mm



2101S-200



4.5 mm	3.0 mm	3	2101S-200

VDE Insulated Cable Cutters



2250V



170 mm	0-10 mm	2	2250V-170
230 mm	0-15 mm	2	2250V-230

ERGO™ Combination Pliers with Insulated Dual-Component Handles and Phosphate Finish



2628S



2.0 mm	1.8 mm	3	2628 S-160
2.5 mm	2.0 mm	3	2628 S-180
3.0 mm	2.5 mm	3	2628 S-200

VDE Insulated Side Cutting Pliers



2171V



2.7 mm	160 mm	2	2171V-160
2.8 mm	180 mm	2	2171V-180
4.0 mm	200 mm	2	2171V-200

Insulated Bolt Cutters



2820VBC



630 mm		1	2820VBC

Reinforced Combination Pliers with Insulated Dual-Component Handles and Chrome Finish



2630SC



180 mm		3	2630SC-180

VDE Insulated End Cutting Pliers



527V



2 mm	160 mm	2	527V-160
2.5 mm	200 mm	2	527V-200

Side Cutting Pliers with Insulated Cellulose Acetate Handles and Nickel-Chrome Finish



2674 NVDE



3.7 mm	2.0 mm	1	2674 NVDE

VDE Insulated Combination Pliers



2678V



2.7 mm	160 mm	2	2678V-160
3.0 mm	180 mm	2	2678V-180
4.0 mm	200 mm	2	2678V-200



ERGO™ Snipe Nose Pliers with Insulated Dual-Component Handles and Phosphate Finish



2430S

2.5 mm	1.8 mm	3	2430S-140
3.0 mm	1.8 mm	3	2430 S-160
3.0 mm	1.8 mm	3	2430 S-200

ERGO™ Round Nose Pliers with Insulated Dual-Component Handles and Phosphate Finish



2521S

140 mm	3	2521S-140
160 mm	3	2521S-160

VDE Insulated Long Flat Nose Pliers



2421V

160 mm	2	2421V-160

ERGO™ 45° Bent Tip Snipe Nose Pliers with Insulated Dual-Component Handles and Phosphate Finish



2427S

3.0 mm	1.8 mm	3	2427S-160
3.0 mm	1.8 mm	3	2427 S-200

VDE Insulated Snipe Nose Pliers



2430V

3.0 mm	160 mm	2	2430V-160
3.0 mm	200 mm	2	2430V-200

VDE Insulated Round Nose Pliers



2521V

160 mm	2	2521V-160

ERGO™ Long Flat Nose Pliers with Insulated Dual-Component Handles and Phosphate Finish



2421S

140 mm	3	2421S-140
160 mm	3	2421S-160
180 mm	3	2421S-180

VDE Insulated 45° Tip Angled Snipe Nose Pliers



2427V

3.0 mm	200 mm	2	2427V-200

ERGO™ Wire Stripping Pliers with Insulated Dual-Component Handles and Phosphate Finish



2223S

165 mm	3	2223 S-150

VDE Insulated Wire Stripping Pliers



2223V

160 mm	0.5-5 mm	2	2223V-160



Insulated Quick-Adjust Water Pump Pliers with Dual-Component Handle



7224S

16	250 mm	4 7224S



ISO 8976, IEC 60900

WRENCHES

Insulated Thumb Screw Adjustable Wrenches



8070V - 8074V

165mm/6"	2	8070V
205mm/8"	2	8071V
260mm/10"	2	8072V
310mm/12"	2	8073V
390mm/15"	2	8074V



Insulated Side Screw Adjustable Wrenches



8070VL-8073VL

160mm/6"	1	8070VL
210mm/8"	1	8071VL
260mm/10"	1	8072VL
310mm/12"	1	8073VL



Side Screw Insulated Adjustable Wrenches



8071VLT - 8073VLT

205mm/8"	1	8071VLT
255mm/10"	1	8072VLT
305mm/12"	1	8073VLT



Insulated Open End Wrenches



6MV

6 mm	5	6MV-6
7 mm	5	6MV-7
8 mm	5	6MV-8
9 mm	5	6MV-9
10 mm	5	6MV-10
11 mm	5	6MV-11
12 mm	5	6MV-12
13 mm	5	6MV-13
14 mm	5	6MV-14
15 mm	5	6MV-15
16 mm	5	6MV-16
17 mm	3	6MV-17
18 mm	3	6MV-18
19 mm	3	6MV-19
20 mm	3	6MV-20
21 mm	3	6MV-21
22 mm	3	6MV-22
23 mm	3	6MV-23



24 mm	3	6MV-24
27 mm	2	6MV-27
30 mm	2	6MV-30
32 mm	2	6MV-32

Insulated Offset Ring Spanners



2MV

6.0 mm	5	2MV-6
7.0 mm	5	2MV-7
8.0 mm	5	2MV-8
9.0 mm	5	2MV-9
10.0 mm	5	2MV-10
11.0 mm	5	2MV-11
12.0 mm	5	2MV-12
13.0 mm	5	2MV-13
14.0 mm	5	2MV-14
15.0 mm	5	2MV-15
16.0 mm	5	2MV-16
17.0 mm	3	2MV-17
18.0 mm	3	2MV-18
19.0 mm	3	2MV-19
21.0 mm	3	2MV-21
22.0 mm	3	2MV-22
23.0 mm	3	2MV-23
24.0 mm	3	2MV-24



Insulated T-Handle Socket Wrenches



28MV

8.0 mm	2	28MV-8
9.0 mm	2	28MV-9
10.0 mm	2	28MV-10
11.0 mm	2	28MV-11
12.0 mm	2	28MV-12
13.0 mm	2	28MV-13
14.0 mm	2	28MV-14
15.0 mm	2	28MV-15
16.0 mm	2	28MV-16
17.0 mm	2	28MV-17
18.0 mm	2	28MV-18
19.0 mm	2	28MV-19
20.0 mm	2	28MV-20
21.0 mm	2	28MV-21
22.0 mm	2	28MV-22



Insulated Hexagon L-Keys



1999MV



Size	Quantity	Part Number
3 mm	5	1999MV-3
4 mm	5	1999MV-4
5 mm	5	1999MV-5
6 mm	5	1999MV-6
7 mm	5	1999MV-7
8 mm	5	1999MV-8
9 mm	5	1999MV-9
10 mm	3	1999MV-10
12 mm	3	1999MV-12

INSULATED SOCKETS & RATCHETS

1/2" VDE Insulated Sockets 8 mm-32 mm



7800DMV



Size	Quantity	Part Number
8 mm	10	7800DMV-8
10 mm	10	7800DMV-10
11 mm	10	7800DMV-11
12 mm	10	7800DMV-12
13 mm	10	7800DMV-13
14 mm	10	7800DMV-14
15 mm	10	7800DMV-15
16 mm	10	7800DMV-16
17 mm	10	7800DMV-17
18 mm	10	7800DMV-18
19 mm	10	7800DMV-19
20 mm	10	7800DMV-20
21 mm	10	7800DMV-21
22 mm	10	7800DMV-22
24 mm	5	7800DMV-24
27 mm	5	7800DMV-27
30 mm	5	7800DMV-30
32 mm	5	7800DMV-32

1/2" VDE Insulated Ratchets 270 mm



8150-1/2V



Length	Quantity	Part Number
270 mm	1	8150-1/2V

1/2" VDE Insulated T-Handles 200 mm



8154-1/2V



Length	Width	Quantity	Part Number
200 mm	190 mm	1	8154-1/2V

1/2" VDE Insulated Extensions 125 mm-250 mm



8160-1/2V - 8162-1/2V



Length	Quantity	Part Number
125 mm	1	8160-1/2V
250 mm	1	8162-1/2V

SCISSORS & KNIVES

Insulated Electrician Scissors with Finger Guard



SC127V



Blade Length	Handle Length	Quantity	Part Number
50 mm	130 mm	5	SC127V

Insulated Electrician Scissors



SC150NGV



Blade Length	Handle Length	Quantity	Part Number
38 mm	150 mm	5	SC150NGV

Insulated Straight Knives



2820VP



Blade Length	Handle Length	Quantity	Part Number
50 mm	180 mm	2	2820VP

VDE Insulated Bent Knives



2820VPC



50 mm	180 mm	2	2820VPC

Insulated Bent Knives with Guide



2820VHELP



38 mm	180 mm	1	2820VHELP

Insulated Cable Knives with Plastic Protective Cap



2820VDE



55.5 mm	180 mm	10	2820VDE

TWEEZERS

General Purpose Insulated Tweezers 150 mm



2820VTEE



	145 mm	1	2820VTEE

PROTECTIVE EQUIPMENT

Insulated Fuse Pullers for NH 00-3



2820VFP



458 g	1	2820VFP

Insulating Mats for 1000VAC



2820VM



1000 mm	1000 mm	1	2820VM

Insulating Gloves 550 VAC-1000 VAC



2820VG



500 V 1000 V	1	2820VG05 1 2820VG10

Cotton Gloves to Wear Under Insulated Gloves



2820VGCOT

50 g	1	2820VGCOT

THIS ITEM IS NOT INSULATED AND HAS TO BE USED WITH INSULATED GLOVES

TOOLSETS

ERGO™ All-Round Pliers Tool Set Insulated - 3 pcs



9897S/3

3	50 x 180 x 400 mm	1 9897S/3

2628 S-180		1000 V IEC60900
2101S-160		1000 V IEC60900
2430 S-200		1000 V IEC60900



Insulated Open End Wrench Set - 8 Pcs



6MV/



8 mm

1 6MV/8T

6MV-10, 6MV-11, 6MV-12, 6MV-13,
6MV-14, 6MV-17, 6MV-18, 6MV-19



Insulated Open End Wrench Set - 10 Pcs



6MV/10T_1



10 mm

1 6MV/10T

6MV-10, 6MV-11, 6MV-12, 6MV-13,
6MV-14, 6MV-16, 6MV-17, 6MV-18,
6MV-19, 6MV-22



1/2" VDE Insulated Socket Set - 11 Pcs



7811DMV



11 270 x 79 x 350 mm

1 7811DMV

BAHCO

7800DMV-13, 7800DMV-10, 7800DMV-11, 7800DMV-22, 7800DMV-17, 7800DMV-19, 7800DMV-20



8150-1/2V



8154-1/2V



8160-1/2V



BE-8050S



Foldable Case Insulated Electrician's Toolset - 10 Pcs



3045/1VDE



10 225 x 70 x 300 mm 1 3045/1VDE

BE-8010S, BE-8040S, BE-8050S, BE-8220S, BE-8230S, BE-8255S



BE-8620S



2171V-160



2430V-160



2678V-180



Leather Briefcase Insulated Electrician's Toolset - 10 Pcs



3045V-1



10 60 x 240 x 330 mm 1 3045V-1

2171V-160



2678V-180



2223V-160



BE-8220S, BE-8040S, BE-8050S



BE-8610S, BE-8620S



2820VP



SC127V



Insulated Toolset within Leather Bag - 19 Pcs



3045V-2



19 200 x 285 x 445 mm 1 3045V-2

2171V-160



2678V-180



2430V-160



2223V-160



BE-8220S, BE-8040S, BE-8050S, BE-8255S



BE-8610S, BE-8620S



6MV-10, 6MV-11, 6MV-13, 6MV-12,
6MV-14, 6MV-17, 6MV-19



2820VP



SC150NGV





Non Sparking Tools



WRENCHES

Non-Sparking Central Nut Adjustable
Wrenches Aluminium Bronze



NS001

Icon	L	Icon	Icon
18 mm	150mm/6"	5	NS001-150
24 mm	200mm/8"	5	NS001-200
30 mm	250mm/10"	5	NS001-250
36 mm	300mm/12"	5	NS001-300
46 mm	375mm/15"	5	NS001-375
55 mm	450mm/18"	3	NS001-450
65 mm	600mm/24"	1	NS001-600
75 mm	900mm/36"	1	NS001-900

Non-Sparking Central Nut Adjustable
Wrenches Copper Beryllium



NSB001

Icon	L	Icon	Icon
18 mm	150mm/6"	5	NSB001-150
24 mm	200mm/8"	5	NSB001-200
30 mm	250mm/10"	5	NSB001-250
36 mm	300mm/12"	5	NSB001-300
48 mm	375mm/15"	5	NSB001-375
55 mm	450mm/18"	3	NSB001-450
65 mm	600mm/24"	3	NSB001-600
75 mm	900mm/36"	1	NSB001-900

BAM/ZBF/003/21

Non-Sparking Metric Combination
Wrenches Aluminium Bronze



NS002

Icon	Icon	Icon
6 mm	5	NS002-6
7 mm	5	NS002-7
8 mm	5	NS002-8
9 mm	5	NS002-9
10 mm	10	NS002-10
11 mm	5	NS002-11
12 mm	5	NS002-12

Icon	Icon	Icon
13 mm	10	NS002-13
14 mm	5	NS002-14
15 mm	5	NS002-15
16 mm	5	NS002-16
17 mm	10	NS002-17
18 mm	5	NS002-18
19 mm	10	NS002-19
20 mm	5	NS002-20
21 mm	5	NS002-21
22 mm	10	NS002-22
23 mm	5	NS002-23
24 mm	10	NS002-24
25 mm	5	NS002-25
26 mm	5	NS002-26
27 mm	5	NS002-27
28 mm	5	NS002-28
29 mm	10	NS002-29
30 mm	10	NS002-30
31 mm	5	NS002-31
32 mm	5	NS002-32
33 mm	5	NS002-33
34 mm	5	NS002-34
35 mm	5	NS002-35
36 mm	5	NS002-36
38 mm	5	NS002-38
40 mm	5	NS002-40
41 mm	5	NS002-41
42 mm	5	NS002-42
46 mm	5	NS002-46
50 mm	5	NS002-50
52 mm	5	NS002-52
55 mm	5	NS002-55
60 mm	1	NS002-60
65 mm	1	NS002-65
70 mm	1	NS002-70
75 mm	1	NS002-75
80 mm	1	NS002-80

BAM/ZBF/002/21

Non-Sparking Metric Combination
Wrenches Copper Beryllium



NSB002

Icon	Icon	Icon
6 mm	5	NSB002-6
7 mm	5	NSB002-7
8 mm	5	NSB002-8
9 mm	5	NSB002-9
10 mm	5	NSB002-10
11 mm	5	NSB002-11
12 mm	5	NSB002-12
13 mm	5	NSB002-13
17 mm	5	NSB002-17
14 mm	5	NSB002-14
15 mm	5	NSB002-15
16 mm	5	NSB002-16
18 mm	5	NSB002-18
19 mm	5	NSB002-19
20 mm	5	NSB002-20
21 mm	5	NSB002-21
22 mm	5	NSB002-22
25 mm	5	NSB002-25
23 mm	5	NSB002-23
26 mm	5	NSB002-26

Icon	Icon	Icon
24 mm	5	NSB002-24
27 mm	5	NSB002-27
28 mm	5	NSB002-28
29 mm	5	NSB002-29
30 mm	5	NSB002-30
31 mm	1	NSB002-31
32 mm	10	NSB002-32
33 mm	1	NSB002-33
34 mm	1	NSB002-34
35 mm	1	NSB002-35
36 mm	5	NSB002-36
38 mm	1	NSB002-38
40 mm	1	NSB002-40
41 mm	5	NSB002-41
42 mm	1	NSB002-42
46 mm	1	NSB002-46
50 mm	1	NSB002-50
52 mm	1	NSB002-52
55 mm	1	NSB002-55
60 mm	1	NSB002-60
65 mm	1	NSB002-65
70 mm	1	NSB002-70
75 mm	1	NSB002-75
80 mm	1	NSB002-80

BAM/ZBF/003/21

Non-Sparking Imperial Combination
Wrenches Aluminium Bronze



NS003



Icon	Icon	Icon
1/4 in	1	NS003-8
11/32 in	1	NS003-11
3/8 in	1	NS003-12
7/16 in	1	NS003-14
1/2 in	1	NS003-16
9/16 in	1	NS003-18
5/8 in	1	NS003-20
3/4 in	1	NS003-24
7/8 in	1	NS003-28
15/16 in	1	NS003-30

Non-Sparking Imperial Combination
Wrenches Copper Beryllium



NSB003

Icon	Icon	Icon
1/4 in	1	NSB003-8
5/16 in	1	NSB003-10
11/32 in	1	NSB003-11
3/8 in	5	NSB003-12



	 	
13/32 in	1	NSB003-13
7/16 in	1	NSB003-14
1/2 in	5	NSB003-16
9/16 in	1	NSB003-18
19/32 in	1	NSB003-19
5/8 in	1	NSB003-20
11/16 in	5	NSB003-22
3/4 in	5	NSB003-24
25/32 in	1	NSB003-25
13/16 in	1	NSB003-26
7/8 in	5	NSB003-28
15/16 in	1	NSB003-30
31/32 in	1	NSB003-31
1 in	1	NSB003-32
1.1/16 in	1	NSB003-34
1.1/8 in	1	NSB003-36
1.3/16 in	1	NSB003-38
1.1/4 in	1	NSB003-40
1.5/16 in	1	NSB003-42
1.3/8 in	5	NSB003-44
1.7/16 in	1	NSB003-46
1.1/2 in	1	NSB003-48
1.9/16 in	1	NSB003-50
1.5/8 in	1	NSB003-52
1.11/16 in	1	NSB003-54
1.3/4 in	1	NSB003-56
1.13/16 in	1	NSB003-58
1.7/8 in	1	NSB003-60
1.15/16 in	1	NSB003-62
2 in	5	NSB003-64
2.1/8 in	1	NSB003-68
2.1/4 in	1	NSB003-72
2.1/2 in	1	NSB003-80
2.5/8 in	1	NSB003-84
2.3/4 in	1	NSB003-88



BAM/ZBF/003/21

Non-Sparking Metric Double Open Ended Wrenches Aluminium Bronze



NS006

	 	
6x7 mm	1	NS006-0607
6x8 mm	1	NS006-0608
7x8 mm	1	NS006-0708
7x9 mm	1	NS006-0709
8x9 mm	1	NS006-0809
8x10 mm	1	NS006-0810
9x10 mm	1	NS006-0910
9x11 mm	1	NS006-0911
10x11 mm	1	NS006-1011
10x12 mm	1	NS006-1012
10x13 mm	1	NS006-1013
10x14 mm	1	NS006-1014
11x13 mm	1	NS006-1113
11x14 mm	1	NS006-1114
12x13 mm	1	NS006-1213
12x14 mm	1	NS006-1214
13x15 mm	1	NS006-1315
14x15 mm	1	NS006-1415
14x16 mm	1	NS006-1416
14x17 mm	1	NS006-1417
16x17 mm	1	NS006-1617



	 	
16x18 mm	1	NS006-1618
17x19 mm	1	NS006-1719
17x22 mm	1	NS006-1722
18x19 mm	1	NS006-1819
18x20 mm	1	NS006-1820
19x20 mm	1	NS006-1920
19x22 mm	1	NS006-1922
19x24 mm	1	NS006-1924
20x22 mm	1	NS006-2022
21x22 mm	1	NS006-2122
21x23 mm	1	NS006-2123
22x23 mm	1	NS006-2223
22x24 mm	1	NS006-2224
22x27 mm	1	NS006-2227
23x26 mm	1	NS006-2326
24x25 mm	1	NS006-2425
24x26 mm	1	NS006-2426
24x27 mm	1	NS006-2427
24x30 mm	1	NS006-2430
25x28 mm	1	NS006-2528
26x29 mm	1	NS006-2629
27x29 mm	1	NS006-2729
27x30 mm	1	NS006-2730
27x32 mm	1	NS006-2732
28x30 mm	1	NS006-2830
30x31 mm	1	NS006-3031
30x32 mm	1	NS006-3032
30x34 mm	1	NS006-3034
30x36 mm	1	NS006-3036
32x34 mm	1	NS006-3234
32x35 mm	1	NS006-3235
32x36 mm	1	NS006-3236
33x35 mm	1	NS006-3335
34x36 mm	1	NS006-3436
35x36 mm	1	NS006-3536
36x38 mm	1	NS006-3638
36x41 mm	1	NS006-3641
38x42 mm	1	NS006-3642
41x46 mm	1	NS006-4146
46x50 mm	1	NS006-4650
50x52 mm	1	NS006-5052
50x55 mm	1	NS006-5055
50x60 mm	1	NS006-5060
50x62 mm	1	NS006-5062
55x60 mm	1	NS006-5560
60x65 mm	1	NS006-6065
65x70 mm	1	NS006-6570



BAM/ZBF/002/21

Non-Sparking Metric Double Open Ended Wrenches Copper Beryllium



NSB006

	 	
6X7 mm	1	NSB006-0607
6X8 mm	1	NSB006-0608
7X8 mm	1	NSB006-0708
7X9 mm	1	NSB006-0709

	 	
8X9 mm	1	NSB006-0809
8X10 mm	1	NSB006-0810
9X10 mm	1	NSB006-0910
9X11 mm	1	NSB006-0911
10X11 mm	1	NSB006-1011
10X12 mm	1	NSB006-1012
10X13 mm	1	NSB006-1013
10X14 mm	1	NSB006-1014
11X13 mm	1	NSB006-1113
11X14 mm	1	NSB006-1114
12X13 mm	1	NSB006-1213
12X14 mm	1	NSB006-1214
13X15 mm	1	NSB006-1315
14X15 mm	1	NSB006-1415
14X16 mm	1	NSB006-1416
14X17 mm	1	NSB006-1417
16X17 mm	1	NSB006-1617
16X18 mm	1	NSB006-1618
17X19 mm	1	NSB006-1719
17X22 mm	1	NSB006-1722
18X19 mm	1	NSB006-1819
18X20 mm	1	NSB006-1820
19X20 mm	1	NSB006-1920
19X22 mm	1	NSB006-1922
19X24 mm	1	NSB006-1924
20X22 mm	1	NSB006-2022
21X22 mm	1	NSB006-2122
21X23 mm	1	NSB006-2123
22X23 mm	1	NSB006-2223
22X24 mm	1	NSB006-2224
22X27 mm	1	NSB006-2227
23X26 mm	1	NSB006-2326
24X25 mm	1	NSB006-2425
24X26 mm	1	NSB006-2426
24X27 mm	1	NSB006-2427
24X30 mm	1	NSB006-2430
25x28 mm	1	NSB006-2528
26x29 mm	1	NSB006-2629
27x29 mm	1	NSB006-2729
27x30 mm	1	NSB006-2730
27x32 mm	1	NSB006-2732
28x30 mm	1	NSB006-2830
30x31 mm	1	NSB006-3031
30x32 mm	1	NSB006-3032
30x34 mm	1	NSB006-3034
30x36 mm	1	NSB006-3036
32x34 mm	1	NSB006-3234
32x35 mm	1	NSB006-3235
32x36 mm	1	NSB006-3236
33x35 mm	1	NSB006-3335
34x36 mm	1	NSB006-3436
35x36 mm	1	NSB006-3536
36x38 mm	1	NSB006-3638
36x41 mm	1	NSB006-3641
38x42 mm	1	NSB006-3642
41x46 mm	1	NSB006-4146
46x50 mm	1	NSB006-4650
50x52 mm	1	NSB006-5052
50x55 mm	1	NSB006-5055
50x60 mm	1	NSB006-5060
50x62 mm	1	NSB006-5062
55X60 mm	1	NSB006-5560
60X65 mm	1	NSB006-6065
65X70 mm	1	NSB006-6570

BAM/ZBF/003/21



Non-Sparking Metric Double Ended Flat Ring Wrenches Aluminium Bronze

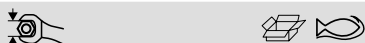

NS010



6x7 mm	1	NS010-0607
7x9 mm	1	NS010-0709
8x9 mm	1	NS010-0809
9x11 mm	1	NS010-0911
10x11 mm	1	NS010-1011
10x12 mm	1	NS010-1012
12x14 mm	1	NS010-1214
13x15 mm	1	NS010-1315
14x17 mm	1	NS010-1417
16x18 mm	1	NS010-1618
17x19 mm	1	NS010-1719
17x22 mm	1	NS010-1722
18x19 mm	1	NS010-1819
19x21 mm	1	NS010-1921
19x22 mm	1	NS010-1922
20x22 mm	1	NS010-2022
21x23 mm	1	NS010-2123
22x24 mm	1	NS010-2224
24x27 mm	1	NS010-2427
25x28 mm	1	NS010-2528
26x28 mm	1	NS010-2628
27x30 mm	1	NS010-2730
27x32 mm	1	NS010-2732
30x32 mm	1	NS010-3032
30x36 mm	1	NS010-3036
32x36 mm	1	NS010-3236
36x41 mm	1	NS010-3641
41x46 mm	1	NS010-4146
46x50 mm	1	NS010-4650

BAM/ZBF/002/21

10X11 mm	1	NSB010-1011
10X12 mm	1	NSB010-1012
12X14 mm	1	NSB010-1214
13X15 mm	1	NSB010-1315
14X17 mm	1	NSB010-1417
16X18 mm	1	NSB010-1618
17X19 mm	1	NSB010-1719
17X22 mm	1	NSB010-1722
18X19 mm	1	NSB010-1819
19X21 mm	1	NSB010-1921
19X22 mm	1	NSB010-1922
20X22 mm	1	NSB010-2022
21X23 mm	1	NSB010-2123
22X24 mm	1	NSB010-2224
24X27 mm	1	NSB010-2427
25X28 mm	1	NSB010-2528
26X28 mm	1	NSB010-2628
27X30 mm	1	NSB010-2730
27X32 mm	1	NSB010-2732
30X32 mm	1	NSB010-3032
30X36 mm	1	NSB010-3036
32X36 mm	1	NSB010-3236
36X41 mm	1	NSB010-3641
41X46 mm	1	NSB010-4146
46X50 mm	1	NSB010-4650

BAM/ZBF/003/21

Non-Sparking Metric Double Ended Offset Ring Wrenches Aluminium Bronze



Non-Sparking Metric Double Ended Offset Ring Wrenches Copper Beryllium



NSB011



6x7 mm	1	NSB011-0607
8x9 mm	1	NSB011-0809
10x11 mm	1	NSB011-1011
12x13 mm	1	NSB011-1213
14x15 mm	1	NSB011-1415
16x17 mm	1	NSB011-1617
18x19 mm	1	NSB011-1819
20x22 mm	1	NSB011-2022
21x23 mm	1	NSB011-2123
24x26 mm	1	NSB011-2426
25x28 mm	1	NSB011-2528
27x29 mm	1	NSB011-2729
30x32 mm	1	NSB011-3032

BAM/ZBF/003/21

Non-Sparking Metric Slogging Open Wrenches Aluminium Bronze



Non-Sparking Metric Double Ended Flat Ring Wrenches Copper Beryllium



NSB010



6X7 mm	1	NSB010-0607
7X9 mm	1	NSB010-0709
8X9 mm	1	NSB010-0809
9X11 mm	1	NSB010-0911

NS011

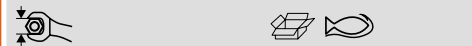



6x7 mm	1	NS011-0607
8x9 mm	1	NS011-0809
10x11 mm	1	NS011-1011
12x13 mm	1	NS011-1213
14x15 mm	1	NS011-1415
16x17 mm	1	NS011-1617
18x19 mm	1	NS011-1819
20x22 mm	1	NS011-2022
21x23 mm	1	NS011-2123
24x26 mm	1	NS011-2426
25x28 mm	1	NS011-2528
27x29 mm	1	NS011-2729
30x32 mm	1	NS011-3032

BAM/ZBF/002/21

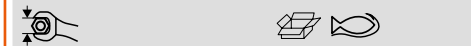
NS100



17 mm	1	NS100-17
19 mm	1	NS100-19
22 mm	1	NS100-22
24 mm	1	NS100-24
25 mm	1	NS100-25
27 mm	1	NS100-27
28 mm	1	NS100-28
29 mm	1	NS100-29
30 mm	1	NS100-30
32 mm	1	NS100-32
33 mm	1	NS100-33
34 mm	1	NS100-34
35 mm	1	NS100-35
36 mm	1	NS100-36
37 mm	1	NS100-37
38 mm	1	NS100-38
41 mm	1	NS100-41
42 mm	1	NS100-42



		
45 mm	1	NS100-45
46 mm	1	NS100-46
47 mm	1	NS100-47
50 mm	1	NS100-50
52 mm	1	NS100-52
54 mm	1	NS100-54
55 mm	1	NS100-55
56 mm	1	NS100-56
58 mm	1	NS100-58
60 mm	1	NS100-60
63 mm	1	NS100-63
65 mm	1	NS100-65
67 mm	1	NS100-67
70 mm	1	NS100-70
71 mm	1	NS100-71
75 mm	1	NS100-75
77 mm	1	NS100-77
80 mm	1	NS100-80
82 mm	1	NS100-82
85 mm	1	NS100-85
88 mm	1	NS100-88
90 mm	1	NS100-90
94 mm	1	NS100-94
95 mm	1	NS100-95
100 mm	1	NS100-100
105 mm	1	NS100-105
110 mm	1	NS100-110
115 mm	1	NS100-115
120 mm	1	NS100-120



BAM/ZBF/002/21

Non-Sparking Metric Slogging Open Wrenches Copper Beryllium



NSB100

		
17 mm	1	NSB100-17
19 mm	1	NSB100-19
22 mm	1	NSB100-22
24 mm	1	NSB100-24
25 mm	1	NSB100-25
27 mm	1	NSB100-27
28 mm	1	NSB100-28
29 mm	1	NSB100-29
30 mm	1	NSB100-30
32 mm	1	NSB100-32
33 mm	1	NSB100-33
34 mm	1	NSB100-34
35 mm	1	NSB100-35
36 mm	1	NSB100-36
37 mm	1	NSB100-37



		
38 mm	1	NSB100-38
41 mm	1	NSB100-41
42 mm	1	NSB100-42
45 mm	1	NSB100-45
46 mm	1	NSB100-46
47 mm	1	NSB100-47
50 mm	1	NSB100-50
52 mm	1	NSB100-52
54 mm	1	NSB100-54
55 mm	1	NSB100-55
56 mm	1	NSB100-56
58 mm	1	NSB100-58
60 mm	1	NSB100-60
63 mm	1	NSB100-63
65 mm	1	NSB100-65
67 mm	1	NSB100-67
70 mm	1	NSB100-70
71 mm	1	NSB100-71
75 mm	1	NSB100-75
77 mm	1	NSB100-77
80 mm	1	NSB100-80
82 mm	1	NSB100-82
85 mm	1	NSB100-85
88 mm	1	NSB100-88
90 mm	1	NSB100-90
94 mm	1	NSB100-94
95 mm	1	NSB100-95
100 mm	1	NSB100-100
105 mm	1	NSB100-105
110 mm	1	NSB100-110
115 mm	1	NSB100-115
120 mm	1	NSB100-120



BAM/ZBF/003/21

Non-Sparking Metric Slogging Ring Wrenches Aluminium Bronze



NS104

		
17 mm	1	NS104-17
19 mm	1	NS104-19
20 mm	1	NS104-20
22 mm	1	NS104-22
24 mm	1	NS104-24
25 mm	1	NS104-25
26 mm	1	NS104-26
27 mm	1	NS104-27
28 mm	1	NS104-28
29 mm	1	NS104-29
30 mm	1	NS104-30
31 mm	1	NS104-31
32 mm	1	NS104-32

		
33 mm	1	NS104-33
34 mm	1	NS104-34
35 mm	1	NS104-35
36 mm	1	NS104-36
37 mm	1	NS104-37
38 mm	1	NS104-38
39 mm	1	NS104-39
40 mm	1	NS104-40
41 mm	1	NS104-41
42 mm	1	NS104-42
43 mm	1	NS104-43
44 mm	1	NS104-44
45 mm	1	NS104-45
46 mm	1	NS104-46
47 mm	1	NS104-47
48 mm	1	NS104-48
49 mm	1	NS104-49
50 mm	1	NS104-50
51 mm	1	NS104-51
52 mm	1	NS104-52
53 mm	1	NS104-53
54 mm	1	NS104-54
55 mm	1	NS104-55
56 mm	1	NS104-56
57 mm	1	NS104-57
58 mm	1	NS104-58
59 mm	1	NS104-59
60 mm	1	NS104-60
61 mm	1	NS104-61
62 mm	1	NS104-62
63 mm	1	NS104-63
64 mm	1	NS104-64
65 mm	1	NS104-65
66 mm	1	NS104-66
67 mm	1	NS104-67
68 mm	1	NS104-68
69 mm	1	NS104-69
70 mm	1	NS104-70
71 mm	1	NS104-71
72 mm	1	NS104-72
73 mm	1	NS104-73
74 mm	1	NS104-74
75 mm	1	NS104-75
76 mm	1	NS104-76
77 mm	1	NS104-77
78 mm	1	NS104-78
79 mm	1	NS104-79
80 mm	1	NS104-80
81 mm	1	NS104-81
82 mm	1	NS104-82
83 mm	1	NS104-83
84 mm	1	NS104-84
85 mm	1	NS104-85
86 mm	1	NS104-86
87 mm	1	NS104-87
88 mm	1	NS104-88
89 mm	1	NS104-89
90 mm	1	NS104-90
92 mm	1	NS104-92
94 mm	1	NS104-94
95 mm	1	NS104-95
98 mm	1	NS104-98
100 mm	1	NS104-100
105 mm	1	NS104-105
110 mm	1	NS104-110
115 mm	1	NS104-115
120 mm	1	NS104-120

BAM/ZBF/002/21



Non-Sparking Metric Slogging Ring
Wrenches Copper Beryllium



NSB104



17 mm	1	NSB104-17
19 mm	1	NSB104-19
20 mm	1	NSB104-20
22 mm	1	NSB104-22
24 mm	1	NSB104-24
25 mm	1	NSB104-25
26 mm	1	NSB104-26
27 mm	1	NSB104-27
28 mm	1	NSB104-28
29 mm	1	NSB104-29
30 mm	1	NSB104-30
31 mm	1	NSB104-31
32 mm	1	NSB104-32
33 mm	1	NSB104-33
34 mm	1	NSB104-34
35 mm	1	NSB104-35
36 mm	1	NSB104-36
37 mm	1	NSB104-37
38 mm	1	NSB104-38
39 mm	1	NSB104-39
40 mm	1	NSB104-40
41 mm	1	NSB104-41
42 mm	1	NSB104-42
43 mm	1	NSB104-43
44 mm	1	NSB104-44
45 mm	1	NSB104-45
46 mm	1	NSB104-46
47 mm	1	NSB104-47
48 mm	1	NSB104-48
49 mm	1	NSB104-49
50 mm	1	NSB104-50
51 mm	1	NSB104-51
52 mm	1	NSB104-52
53 mm	1	NSB104-53
54 mm	1	NSB104-54
55 mm	1	NSB104-55
56 mm	1	NSB104-56
57 mm	1	NSB104-57
58 mm	1	NSB104-58
59 mm	1	NSB104-59
60 mm	1	NSB104-60
61 mm	1	NSB104-61
62 mm	1	NSB104-62
63 mm	1	NSB104-63
64 mm	1	NSB104-64
65 mm	1	NSB104-65
66 mm	1	NSB104-66
67 mm	1	NSB104-67
68 mm	1	NSB104-68
69 mm	1	NSB104-69
70 mm	1	NSB104-70
71 mm	1	NSB104-71
72 mm	1	NSB104-72
73 mm	1	NSB104-73
74 mm	1	NSB104-74
75 mm	1	NSB104-75
76 mm	1	NSB104-76

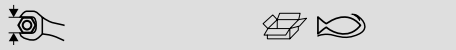

77 mm	1	NSB104-77
78 mm	1	NSB104-78
79 mm	1	NSB104-79
80 mm	1	NSB104-80
81 mm	1	NSB104-81
82 mm	1	NSB104-82
83 mm	1	NSB104-83
84 mm	1	NSB104-84
85 mm	1	NSB104-85
86 mm	1	NSB104-86
87 mm	1	NSB104-87
88 mm	1	NSB104-88
89 mm	1	NSB104-89
90 mm	1	NSB104-90
92 mm	1	NSB104-92
94 mm	1	NSB104-94
95 mm	1	NSB104-95
98 mm	1	NSB104-98
100 mm	1	NSB104-100
105 mm	1	NSB104-105
110 mm	1	NSB104-110
115 mm	1	NSB104-115
120 mm	1	NSB104-120

BAM/ZBF/003/21

Non-Sparking Imperial Slogging Ring
Wrenches Aluminium Bronze



NS106



5/8 in	1	NS106-20
11/16 in	1	NS106-22
3/4 in	1	NS106-24
25/32 in	1	NS106-25
13/16 in	1	NS106-26
7/8 in	1	NS106-28
15/16 in	1	NS106-30
1 in	1	NS106-32
1 1/16 in	1	NS106-34
1 1/8 in	1	NS106-36
1 3/16 in	1	NS106-38
1 1/4 in	1	NS106-40
1 5/16 in	1	NS106-42
1 3/8 in	1	NS106-44
1 13/32 in	1	NS106-45
1 7/16 in	1	NS106-46
1 1/2 in	1	NS106-48
1 9/16 in	1	NS106-50
1 5/8 in	1	NS106-52
1 11/16 in	1	NS106-54
1 3/4 in	1	NS106-56
1 13/16 in	1	NS106-58
1 7/8 in	1	NS106-60
1 15/16 in	1	NS106-62
2 in	1	NS106-64
2 1/16 in	1	NS106-66
2 1/8 in	1	NS106-68
2 3/16 in	1	NS106-70
2 13/64 in	1	NS106-71
2 1/4 in	1	NS106-72

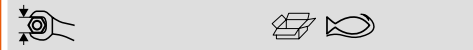

2 5/16 in	1	NS106-74
2 3/8 in	1	NS106-76
2 7/16 in	1	NS106-78
2 1/2 in	1	NS106-80
2 9/16 in	1	NS106-82
2 5/8 in	1	NS106-84
2 3/4 in	1	NS106-88
2 13/16 in	1	NS106-90
2 7/8 in	1	NS106-92
2 15/16 in	1	NS106-94
3 in	1	NS106-96
3 1/16 in	1	NS106-98
3 1/8 in	1	NS106-100
3 1/4 in	1	NS106-104
3 3/8 in	1	NS106-108
3 1/2 in	1	NS106-112
3 9/16 in	1	NS106-114
3 5/8 in	1	NS106-116
3 3/4 in	1	NS106-120
3 7/8 in	1	NS106-124
3 15/16 in	1	NS106-126
4 in	1	NS106-128
4 1/8 in	1	NS106-132
4 1/4 in	1	NS106-136
4 5/16 in	1	NS106-138
4 1/2 in	1	NS106-144
4 9/16 in	1	NS106-146
4 11/16 in	1	NS106-150
4 7/8 in	1	NS106-156
4 15/16 in	1	NS106-158

BAM/ZBF/002/21



Non-Sparking Imperial Slogging Ring
Wrenches Copper Beryllium

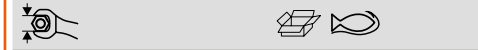

NSB106



5/8 in	1	NSB106-20
11/16 in	1	NSB106-22
3/4 in	1	NSB106-24
25/32 in	1	NSB106-25
13/16 in	1	NSB106-26
7/8 in	1	NSB106-28
15/16 in	1	NSB106-30
1 in	1	NSB106-32
1.1/16 in	1	NSB106-34
1.1/8 in	1	NSB106-36
1.3/16 in	1	NSB106-38
1.1/4 in	1	NSB106-40
1.5/16 in	1	NSB106-42
1.3/8 in	1	NSB106-44
1.13/32 in	1	NSB106-45
1.7/16 in	1	NSB106-46
1.1/2 in	1	NSB106-48
1.9/16 in	1	NSB106-50
1.5/8 in	1	NSB106-52
1.11/16 in	1	NSB106-54
1.3/4 in	1	NSB106-56
1.13/16 in	1	NSB106-58
1.7/8 in	1	NSB106-60

				
1.15/16 in	1			NSB106-62
2 in	1			NSB106-64
2.1/16 in	1			NSB106-66
2.1/8 in	1			NSB106-68
2.3/16 in	1			NSB106-70
2.13/64 in	1			NSB106-71
2.1/4 in	1			NSB106-72
2.5/16 in	1			NSB106-74
2.3/8 in	1			NSB106-76
2.7/16 in	1			NSB106-78
2.1/2 in	1			NSB106-80
2.9/16 in	1			NSB106-82
2.5/8 in	1			NSB106-84
2.3/4 in	1			NSB106-88
2.13/16 in	1			NSB106-90
2.7/8 in	1			NSB106-92
2.15/16 in	1			NSB106-94
3 in	1			NSB106-96
3.1/16 in	1			NSB106-98
3.1/8 in	1			NSB106-100
3.1/4 in	1			NSB106-104
3.3/8 in	1			NSB106-108
3.1/2 in	1			NSB106-112
3.9/16 in	1			NSB106-114
3.5/8 in	1			NSB106-116
3.3/4 in	1			NSB106-120
3.7/8 in	1			NSB106-124
3.15/16 in	1			NSB106-126
4 in	1			NSB106-128
4.1/8 in	1			NSB106-132
4.1/4 in	1			NSB106-136
4.5/16 in	1			NSB106-138
4.1/2 in	1			NSB106-144
4.9/16 in	1			NSB106-146
4.11/16 in	1			NSB106-150
4.7/8 in	1			NSB106-156
4.15/16 in	1			NSB106-158





BAM/ZBF/003/21

PIPE WRENCHES & VALVE TOOLS

Non-Sparking Heavy Duty Pipe Wrenches Aluminium Bronze



NS200





			
25 mm	200 mm	1	NS200-200
30 mm	250 mm	1	NS200-250
40 mm	300 mm	1	NS200-300
50 mm	350 mm	1	NS200-350
60 mm	450 mm	1	NS200-450
75 mm	600 mm	1	NS200-600
85 mm	900 mm	1	NS200-900
110 mm	1200 mm	1	NS200-1200

BAM/ZBF/002/21

Non-Sparking Heavy Duty Pipe Wrenches Copper Beryllium



NSB200

			
25 mm	200 mm	1	NSB200-200
30 mm	250 mm	1	NSB200-250
40 mm	300 mm	1	NSB200-300
50 mm	350 mm	1	NSB200-350
60 mm	450 mm	1	NSB200-450
75 mm	600 mm	1	NSB200-600
85 mm	900 mm	1	NSB200-900
110 mm	1200 mm	1	NSB200-1200

BAM/ZBF/003/21

Non-Sparking Long Valve Wrenches Aluminium Bronze



NS202

		
370 mm	1	NS202-350

BAM/ZBF/002/21

Non-Sparking Long Valve Wrenches Copper Beryllium



NSB202

		
375 mm	1	NSB202-350





BAM/ZBF/003/21

Non-Sparking Valve Wrenches Aluminium Bronze



NS203

			
215 mm	24 mm	1	NS203-200
215 mm	32 mm	1	NS203-215





			
290 mm	36 mm	1	NS203-290
400 mm	48 mm	1	NS203-400
490 mm	60 mm	1	NS203-490
800 mm	60 mm	1	NS203-800

BAM/ZBF/002/21

Non-Sparking Valve Wrenches Copper Beryllium



NSB203



			
215 mm	24 mm	1	NSB203-200
215 mm	32 mm	1	NSB203-215
290 mm	36 mm	1	NSB203-290
400 mm	48 mm	1	NSB203-400
490 mm	60 mm	1	NSB203-490
800 mm	60 mm	1	NSB203-800

BAM/ZBF/003/21

Non-Sparking Valve Hooks Aluminium Bronze



NS204

		
200 mm	1	NS204-30
300 mm	1	NS204-32
250 mm	1	NS204-35
300 mm	1	NS204-40
350 mm	1	NS204-45
375 mm	1	NS204-48
400 mm	1	NS204-50
450 mm	1	NS204-55
500 mm	1	NS204-60
550 mm	1	NS204-65
600 mm	1	NS204-70
650 mm	1	NS204-75
700 mm	1	NS204-80
750 mm	1	NS204-85
800 mm	1	NS204-90

BAM/ZBF/002/21



Non-Sparking Valve Hooks Copper Beryllium



NSB204

Length (mm)	Part Number
200 mm	1 NSB204-30
300 mm	1 NSB204-32
250 mm	1 NSB204-35
300 mm	1 NSB204-40
350 mm	1 NSB204-45
375 mm	1 NSB204-48
400 mm	1 NSB204-50
450 mm	1 NSB204-55
500 mm	1 NSB204-60
550 mm	1 NSB204-65
600 mm	1 NSB204-70
650 mm	1 NSB204-75
700 mm	1 NSB204-80
750 mm	1 NSB204-85
800 mm	1 NSB204-90

BAM/ZBF/003/21

Non-Sparking 3/4" Sockets with Metric Hex Profile Aluminium Bronze



NS224

Size (mm)	Length (mm)	Part Number
17 mm	50 mm	1 NS224-17
18 mm	50 mm	1 NS224-18
19 mm	50 mm	1 NS224-19
21 mm	55 mm	1 NS224-21
22 mm	55 mm	1 NS224-22
23 mm	55 mm	1 NS224-23
24 mm	55 mm	1 NS224-24
26 mm	55 mm	1 NS224-26
27 mm	55 mm	1 NS224-27
28 mm	55 mm	1 NS224-28
29 mm	55 mm	1 NS224-29
30 mm	60 mm	1 NS224-30
32 mm	60 mm	1 NS224-32
34 mm	60 mm	1 NS224-34
36 mm	60 mm	1 NS224-36
38 mm	60 mm	1 NS224-38
41 mm	65 mm	1 NS224-41
46 mm	65 mm	1 NS224-46
50 mm	70 mm	1 NS224-50

BAM/ZBF/002/21

Size (mm)	Length (mm)	Part Number
17 mm	40 mm	1 NS220-17
18 mm	42 mm	1 NS220-18
19 mm	42 mm	1 NS220-19
20 mm	42 mm	1 NS220-20
21 mm	43 mm	1 NS220-21
22 mm	43 mm	1 NS220-22
23 mm	43 mm	1 NS220-23
24 mm	43 mm	1 NS220-24
25 mm	43 mm	1 NS220-25
26 mm	43 mm	1 NS220-26
27 mm	46 mm	1 NS220-27
28 mm	46 mm	1 NS220-28
29 mm	46 mm	1 NS220-29
30 mm	46 mm	1 NS220-30
32 mm	46 mm	1 NS220-32
34 mm	50 mm	1 NS220-34
36 mm	50 mm	1 NS220-36
41 mm	55 mm	1 NS220-41

BAM/ZBF/002/21

Non-Sparking 1/2" Sockets with Metric Hex Profile Copper Beryllium



NSB220

Size (mm)	Length (mm)	Part Number
6 mm	40 mm	1 NSB220-06
7 mm	40 mm	1 NSB220-07
8 mm	40 mm	1 NSB220-08
9 mm	40 mm	1 NSB220-09
10 mm	40 mm	1 NSB220-10
11 mm	40 mm	1 NSB220-11
12 mm	40 mm	1 NSB220-12
13 mm	41 mm	1 NSB220-13
14 mm	40 mm	1 NSB220-14
15 mm	40 mm	1 NSB220-15
16 mm	40 mm	1 NSB220-16
17 mm	41 mm	1 NSB220-17
18 mm	42 mm	1 NSB220-18
19 mm	42 mm	1 NSB220-19
20 mm	42 mm	1 NSB220-20
21 mm	43 mm	1 NSB220-21
22 mm	43 mm	1 NSB220-22
23 mm	44 mm	1 NSB220-23
24 mm	43 mm	1 NSB220-24
25 mm	44 mm	1 NSB220-25
26 mm	43 mm	1 NSB220-26
27 mm	47 mm	1 NSB220-27
28 mm	46 mm	1 NSB220-28
29 mm	47 mm	1 NSB220-29
30 mm	46 mm	1 NSB220-30
32 mm	47 mm	1 NSB220-32

BAM/ZBF/003/21

Non-Sparking 3/4" Sockets with Metric Hex Profile Copper Beryllium



NSB224

Size (mm)	Length (mm)	Part Number
17 mm	50 mm	1 NSB224-17
18 mm	50 mm	1 NSB224-18
19 mm	50 mm	1 NSB224-19
21 mm	55 mm	1 NSB224-21
22 mm	55 mm	1 NSB224-22
23 mm	55 mm	1 NSB224-23
24 mm	56 mm	1 NSB224-24
26 mm	55 mm	1 NSB224-26
27 mm	55 mm	1 NSB224-27
28 mm	55 mm	1 NSB224-28
29 mm	55 mm	1 NSB224-29
30 mm	60 mm	1 NSB224-30
32 mm	61 mm	1 NSB224-32
34 mm	60 mm	1 NSB224-34
36 mm	61 mm	1 NSB224-36
38 mm	60 mm	1 NSB224-38
41 mm	66 mm	1 NSB224-41

SOCKETS & RATCHETS

Non-Sparking 1/2" Sockets with Metric Hex Profile Aluminium Bronze



NS220

Size (mm)	Length (mm)	Part Number
6 mm	40 mm	1 NS220-06
7 mm	40 mm	1 NS220-07
8 mm	40 mm	1 NS220-08
9 mm	40 mm	1 NS220-09
10 mm	40 mm	1 NS220-10
11 mm	40 mm	1 NS220-11
12 mm	40 mm	1 NS220-12
13 mm	40 mm	1 NS220-13
14 mm	40 mm	1 NS220-14
15 mm	40 mm	1 NS220-15
16 mm	40 mm	1 NS220-16

Ø	L	Icons	Part No.
46 mm	65 mm		1 NSB224-46
50 mm	71 mm		1 NSB224-50

BAM/ZBF/003/21

Non-Sparking 1" Sockets with Metric Hex Profile Aluminium Bronze



NS228

Ø	L	Icons	Part No.
22 mm	55 mm		1 NS228-22
24 mm	55 mm		1 NS228-24
26 mm	55 mm		1 NS228-26
27 mm	55 mm		1 NS228-27
28 mm	55 mm		1 NS228-28
29 mm	55 mm		1 NS228-29
30 mm	60 mm		1 NS228-30
31 mm	60 mm		1 NS228-31
32 mm	60 mm		1 NS228-32
34 mm	60 mm		1 NS228-34
36 mm	65 mm		1 NS228-36
38 mm	65 mm		1 NS228-38
41 mm	70 mm		1 NS228-41
46 mm	75 mm		1 NS228-46
50 mm	75 mm		1 NS228-50
55 mm	80 mm		1 NS228-55
60 mm	85 mm		1 NS228-60
65 mm	90 mm		1 NS228-65
70 mm	90 mm		1 NS228-70
75 mm	95 mm		1 NS228-75
80 mm	95 mm		1 NS228-80

BAM/ZBF/002/21

Non-Sparking 1" Sockets with Metric Hex Profile Copper Beryllium



NSB228

Ø	g	Icons	Part No.
22 mm	370 g		1 NSB228-22
24 mm	430 g		1 NSB228-24
26 mm	396 g		1 NSB228-26
27 mm	440 g		1 NSB228-27
28 mm	411 g		1 NSB228-28

Ø	g	Icons	Part No.
29 mm	460 g		1 NSB228-29
30 mm	462 g		1 NSB228-30
31 mm	520 g		1 NSB228-31
32 mm	497 g		1 NSB228-32
34 mm	506 g		1 NSB228-34
36 mm	610 g		1 NSB228-36
38 mm	600 g		1 NSB228-38
41 mm	740 g		1 NSB228-41
46 mm	832 g		1 NSB228-46
50 mm	960 g		1 NSB228-50
55 mm	1130 g		1 NSB228-55
60 mm	1570 g		1 NSB228-60
65 mm	1698 g		1 NSB228-65
70 mm	2350 g		1 NSB228-70
75 mm	3010 g		1 NSB228-75
80 mm	2818 g		1 NSB228-80

BAM/ZBF/003/21

Non-Sparking Adapters Aluminium Bronze



NS232

Ø	Ø	Icons	Part No.
1/2"	3/4"		1 NS232-16-24
3/4"	1/2"		1 NS232-24-16
3/4"	1"		1 NS232-24-32
1"	3/4"		1 NS232-32-24

BAM/ZBF/002/21

Non-Sparking Adapters Copper Beryllium



NSB232

Ø	Ø	Icons	Part No.
1/2"	3/4"		1 NSB232-16-24
3/4"	1/2"		1 NSB232-24-16
3/4"	1"		1 NSB232-24-32
1"	3/4"		1 NSB232-32-24

BAM/ZBF/003/21

Non-Sparking Extensions Aluminium Bronze



NS234

Ø	Ø	Icons	Part No.
1/2"	1/2"		1 NS234-16-100
1/2"	1/2"		1 NS234-16-200
1/2"	1/2"		1 NS234-16-250
3/4"	3/4"		1 NS234-24-200
1"	1"		1 NS234-32-250

BAM/ZBF/002/21

Non-Sparking Extensions Copper Beryllium



NSB234

L	Ø	Icons	Part No.
100 mm	16.4 mm		1 NSB234-16-100
200 mm	16.4 mm		1 NSB234-16-200
250 mm	16.4 mm		1 NSB234-16-250
200 mm	25 mm		1 NSB234-24-200
250 mm	34 mm		1 NSB234-32-250

BAM/ZBF/003/21

Non-Sparking Universal Joints Aluminium Bronze



NS236

Ø	Ø	Icons	Part No.
1/2"	1/2"		1 NS236-16
3/4"	3/4"		1 NS236-24
1"	1"		1 NS236-32

BAM/ZBF/002/21



Non-Sparking Universal Joints Copper Beryllium



NSB236

1/2"	3/4"	1"	1/2"	3/4"	1"	1	NSB236-16	NSB236-24	NSB236-32

BAM/ZBF/003/21

Non-Sparking Sliding T-handles Aluminium Bronze



NS238

1/2"	3/4"	1"	250 mm	260 mm	300 mm	1	NS238-16-250	NS238-24-250	NS238-32-300

BAM/ZBF/002/21

Non-Sparking Sliding T-handles Copper Beryllium



NSB238

1/2"	3/4"	1"	250 mm	250 mm	300 mm	1	NSB238-16-250	NSB238-24-250	NSB238-32-300

BAM/ZBF/003/21

Non-Sparking Offset L-handles Aluminium Bronze



NS240

1/2"	230 mm	1	NS240-16-230

BAM/ZBF/002/21

Non-Sparking Offset L-handles Copper Beryllium



NSB240

1/2"	370 g	1	NSB240-16-230

BAM/ZBF/003/21

Non-Sparking Reversible Ratchets Aluminium Bronze



NS242

1/2"	3/4"	1"	245 mm	320 mm	550 mm	1	NS242-16	NS242-24	NS242-32

BAM/ZBF/002/21

Non-Sparking Reversible Ratchets Copper Beryllium



NSB242

1/2"	3/4"	1"	245 mm	320 mm	550 mm	1	NSB242-16	NSB242-24	NSB242-32

BAM/ZBF/003/21

Non-Sparking Speed Handles Aluminium Bronze



NS243

1/2"	390 mm	1	NS243-16-400

BAM/ZBF/002/21

Non-Sparking Speed Handles Copper Beryllium



NSB243

1/2"	395 mm	1	NSB243-16-400

BAM/ZBF/003/21

Non-Sparking Spark Plug Sockets with Hex Profile Aluminium Bronze



NS247

1/2"	13 mm	1	NS247-26

BAM/ZBF/002/21

Non-Sparking Spark Plug Sockets with Hex Profile Copper Beryllium



NSB247

1/2"	13 mm	1	NSB247-26

BAM/ZBF/003/21

Non-Sparking Screwdriver Sockets Aluminium Bronze



NS248

13 mm	1	NS248-16-52

BAM/ZBF/002/21

Non-Sparking Screwdriver Sockets Copper Beryllium



NSB248

13 mm	1	NSB248-16-52

BAM/ZBF/003/21

SCREWDRIVERS

ERGO™ Non-Sparking Slotted Screwdrivers Aluminium Bronze



NS300

3 mm	50 mm	1	NS300-3-50
3 mm	75 mm	1	NS300-3-75
4 mm	75 mm	1	NS300-4-75
4.5 mm	50 mm	1	NS300-4.5-50
4.5 mm	100 mm	1	NS300-4.5-100
5 mm	75 mm	1	NS300-5-75
5 mm	100 mm	1	NS300-5-100
6 mm	100 mm	1	NS300-6-100
6 mm	125 mm	1	NS300-6-125
6 mm	150 mm	1	NS300-6-150
7 mm	150 mm	1	NS300-7-150
8 mm	150 mm	1	NS300-8-150
8 mm	200 mm	1	NS300-8-200
9 mm	250 mm	1	NS300-9-250
10 mm	200 mm	1	NS300-10-200
10 mm	300 mm	1	NS300-10-300
11 mm	250 mm	1	NS300-11-250
11 mm	300 mm	1	NS300-11-300
11 mm	350 mm	1	NS300-11-350
12 mm	400 mm	1	NS300-12-400
13 mm	450 mm	1	NS300-13-450

BAM/ZBF/002/21

ERGO™ Non-Sparking Slotted Screwdrivers Copper Beryllium



NSB300

3 mm	50 mm	1	NSB300-3-50
3 mm	75 mm	1	NSB300-3-75
4 mm	75 mm	1	NSB300-4-75
4.5 mm	60 mm	1	NSB300-4.5-50
4.5 mm	95 mm	1	NSB300-4.5-100
5 mm	75 mm	1	NSB300-5-75
5 mm	100 mm	1	NSB300-5-100
6 mm	105 mm	1	NSB300-6-100
6 mm	125 mm	1	NSB300-6-125
6 mm	160 mm	1	NSB300-6-150
7 mm	150 mm	1	NSB300-7-150
8 mm	150 mm	1	NSB300-8-150
8 mm	200 mm	1	NSB300-8-200
9 mm	250 mm	1	NSB300-9-250
9 mm	200 mm	1	NSB300-10-200
10 mm	318 mm	1	NSB300-10-300
11 mm	250 mm	1	NSB300-11-250
11 mm	300 mm	1	NSB300-11-300
11 mm	350 mm	1	NSB300-11-350
12 mm	400 mm	1	NSB300-12-400
13 mm	450 mm	1	NSB300-13-450

BAM/ZBF/003/21

ERGO™ Non-Sparking Electrician Flat Tipped Screwdrivers Aluminium Bronze



NS301

3 mm	50 mm	1	NS301-3-50
4 mm	100 mm	1	NS301-4-100
4 mm	150 mm	1	NS301-4-150
5 mm	100 mm	1	NS301-5-100
5 mm	200 mm	1	NS301-5-200
6 mm	100 mm	1	NS301-6-100
8 mm	150 mm	1	NS301-8-150
10 mm	200 mm	1	NS301-10-200
10 mm	300 mm	1	NS301-10-300

BAM/ZBF/002/21



ERGO™ Non-Sparking Electrician Flat Tipped Screwdrivers Copper Beryllium



NSB301

Tip Size	Length	Part No.
3 mm	50 mm	1 NSB301-3-50
4 mm	100 mm	1 NSB301-4-100
4 mm	150 mm	1 NSB301-4-150
5 mm	100 mm	1 NSB301-5-100
5 mm	210 mm	1 NSB301-5-200
6 mm	100 mm	1 NSB301-6-100
8 mm	155 mm	1 NSB301-8-150
10 mm	200 mm	1 NSB301-10-200
10 mm	300 mm	1 NSB301-10-300

BAM/ZBF/003/21

ERGO™ Non-Sparking Phillips Screwdrivers Aluminium Bronze



NS302

Tip Size	Length	Part No.
PH0	50 mm	1 NS302-0-50
PH1	100 mm	1 NS302-1-100
PH2	125 mm	1 NS302-2-125
PH3	150 mm	1 NS302-3-150
PH4	300 mm	1 NS302-4-300

BAM/ZBF/002/21

ERGO™ Non-Sparking Phillips Screwdrivers Copper Beryllium



NSB302

Tip Size	Length	Part No.
PH0	65 mm	1 NSB302-0-50
PH1	120 mm	1 NSB302-1-100
PH2	125 mm	1 NSB302-2-125
PH3	150 mm	1 NSB302-3-150
PH4	300 mm	1 NSB302-4-300

BAM/ZBF/003/21

ERGO™ Non-Sparking Pozidriv Screwdrivers Aluminium Bronze



NS304

Tip Size	Length	Part No.
PZ0	50 mm	1 NS304-0-50
PZ1	100 mm	1 NS304-1-100
PZ2	125 mm	1 NS304-2-125
PZ3	150 mm	1 NS304-3-150
PZ4	300 mm	1 NS304-4-300

BAM/ZBF/002/21

ERGO™ Non-Sparking Pozidriv Screwdrivers Copper Beryllium



NSB304

Tip Size	Length	Part No.
PZ0	50 mm	1 NSB304-0-50
PZ1	100 mm	1 NSB304-1-100
PZ2	125 mm	1 NSB304-2-125
PZ3	150 mm	1 NSB304-3-150
PZ4	300 mm	1 NSB304-4-300

BAM/ZBF/003/21

Non-Sparking Offset Keys Aluminium Bronze



NS320

Tip Size	Length	Part No.
2 mm	59 mm	1 NS320-2
3 mm	59 mm	1 NS320-3
4 mm	65 mm	1 NS320-4
5 mm	79 mm	1 NS320-5
6 mm	85 mm	1 NS320-6
7 mm	88 mm	1 NS320-7
8 mm	92 mm	1 NS320-8
9 mm	99 mm	1 NS320-9
10 mm	110 mm	1 NS320-10

BAM/ZBF/002/21

Non-Sparking Offset Keys Copper Beryllium



NSB320

Tip Size	Length	Part No.
2 mm	59 mm	1 NSB320-2
3 mm	59 mm	1 NSB320-3
4 mm	65 mm	1 NSB320-4
5 mm	79 mm	1 NSB320-5
6 mm	85 mm	1 NSB320-6
7 mm	88 mm	1 NSB320-7
8 mm	93 mm	1 NSB320-8
9 mm	97 mm	1 NSB320-9
10 mm	110 mm	1 NSB320-10

BAM/ZBF/003/21

PLIERS

Non-Sparking Combination Pliers Aluminium Bronze



NS400

Length	Part No.
155 mm	1 NS400-160
175 mm	1 NS400-180
200 mm	1 NS400-200

BAM/ZBF/002/21

Non-Sparking Combination Pliers Copper Beryllium



NSB400

Length	Part No.
157 mm	1 NSB400-160
175 mm	1 NSB400-180
200 mm	1 NSB400-200

BAM/ZBF/003/21

Non-Sparking Diagonal Cutting Pliers
Aluminium Bronze

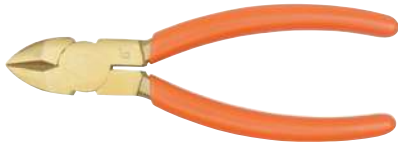

NS402

150 mm	1 NS402-160
200 mm	1 NS402-200

BAM/ZBF/002/21

Non-Sparking Diagonal Cutting Pliers
Copper Beryllium



NSB402

155 mm	1 NSB402-160
200 mm	1 NSB402-200

BAM/ZBF/003/21

Non-Sparking Heavy Duty Diagonal
Cutting Pliers Aluminium Bronze



NS403

150 mm	1 NS403-160
180 mm	1 NS403-180

BAM/ZBF/002/21

Non-Sparking Heavy Duty Diagonal
Cutting Pliers Copper Beryllium



NSB403

155 mm	1 NSB403-160
180 mm	1 NSB403-180

BAM/ZBF/003/21

Non-Sparking Long Flat Nose Pliers
Aluminium Bronze



NS404

150 mm	1 NS404-160

BAM/ZBF/002/21

Non-Sparking Long Flat Nose Pliers
Copper Beryllium



NSB404

155 mm	1 NSB404-160

BAM/ZBF/003/21

Non-Sparking Round Nose Pliers
Aluminium Bronze



NS405

160 mm	1 NS405-160

BAM/ZBF/002/21

Non-Sparking Round Nose Pliers Copper
Beryllium



NSB405

155 mm	1 NSB405-160

BAM/ZBF/003/21

Non-Sparking Long Nose Pliers Aluminium
Bronze



NS406

160 mm	1 NS406-160
180 mm	1 NS406-180
200 mm	1 NS406-200

BAM/ZBF/002/21

Non-Sparking Long Nose Pliers Copper
Beryllium



NSB406

155 mm	1 NSB406-160
180 mm	1 NSB406-180
200 mm	1 NSB406-200

BAM/ZBF/003/21

Non-Sparking Wire Strippers Aluminium
Bronze



NS407

170 mm	1 NS407-160

BAM/ZBF/002/21



Non-Sparking Wire Strippers Copper Beryllium

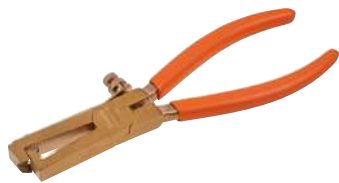

NSB407



170 mm



1 NSB407-160

BAM/ZBF/003/21

Non-Sparking Groove Joint Pliers Aluminium Bronze



NS408



260 mm
300 mm



1 NS408-250
1 NS408-300

BAM/ZBF/002/21

Non-Sparking Groove Joint Pliers Copper Beryllium



NSB408



255 mm
300 mm



1 NSB408-250
1 NSB408-300

BAM/ZBF/003/21

Non-Sparking Slip Joint Pliers Aluminium Bronze



NS412



200 mm



1 NS412-200

BAM/ZBF/002/21

Non-Sparking Slip Joint Pliers Copper Beryllium



NSB412



200 mm



1 NSB412-200

BAM/ZBF/003/21

Non-Sparking Gas Pliers Aluminium Bronze



NS411



200 mm



1 NS411-200

BAM/ZBF/002/21

Non-Sparking Gas Pliers Copper Beryllium



NSB411



205 mm



1 NSB411-200

BAM/ZBF/003/21

Non-Sparking Carpenter's Pincers Aluminium Bronze



NS413



180 mm
195 mm



1 NS413-180
1 NS413-200

BAM/ZBF/002/21

Non-Sparking Carpenter's Pincers Copper Beryllium



NSB413



185 mm
195 mm



1 NSB413-180
1 NSB413-200

BAM/ZBF/003/21

HAMMERS, PRY BARS & CHISELS

Non-Sparking Stoning Hammers with Aluminium Bronze Head and Wooden Handle



NS500



2000 g
2500 g
3000 g
4000 g



1 NS500-2000
1 NS500-2500
1 NS500-3000
1 NS500-4000

BAM/ZBF/002/21

Non-Sparking Stoning Hammers with Copper Beryllium Head and Wooden Handle



NSB500



2000 g
2500 g
3000 g
4000 g



1 NSB500-2000
1 NSB500-2500
1 NSB500-3000
1 NSB500-4000

BAM/ZBF/003/21

Non-Sparking Stoning Hammers with Aluminium Bronze Head and Fibreglass Handle



NS500-FB

Weight	Quantity	Model
1000 g	1	NS500-1000-FB
1500 g	1	NS500-1500-FB
2000 g	1	NS500-2000-FB
2500 g	1	NS500-2500-FB
3000 g	1	NS500-3000-FB
3500 g	1	NS500-3500-FB

BAM/ZBF/002/21

Non-Sparking Stoning Hammers with Copper Beryllium Head and Fibreglass Handle



NSB500-FB

Weight	Quantity	Model
1000 g	1	NSB500-1000-FB
1500 g	1	NSB500-1500-FB
2000 g	1	NSB500-2000-FB
2500 g	1	NSB500-2500-FB
3000 g	1	NSB500-3000-FB
3500 g	1	NSB500-3500-FB

BAM/ZBF/003/21

Non-Sparking Sledge Hammers with Aluminium Bronze Head and Fibreglass Handle



NS502-FB

Weight	Quantity	Model
450 g	1	NS502-450-FB
1000 g	1	NS502-1000-FB
1500 g	1	NS502-1500-FB
2000 g	1	NS502-2000-FB
2500 g	1	NS502-2500-FB

Weight	Quantity	Model
3000 g	1	NS502-3000-FB
4500 g	1	NS502-4500-FB
5000 g	1	NS502-5000-FB
6800 g	1	NS502-6800-FB
8000 g	1	NS502-8000-FB
10000 g	1	NS502-10000-FB
12000 g	1	NS502-12000-FB

BAM/ZBF/002/21

Non-Sparking Sledge Hammers with Copper Beryllium Head and Fibreglass Handle



NSB502-FB

Weight	Quantity	Model
450 g	1	NSB502-450-FB
1000 g	1	NSB502-1000-FB
1500 g	1	NSB502-1500-FB
2000 g	1	NSB502-2000-FB
2500 g	1	NSB502-2500-FB
3000 g	1	NSB502-3000-FB
4500 g	1	NSB502-4500-FB
5000 g	1	NSB502-5000-FB
6800 g	1	NSB502-6800-FB
8000 g	1	NSB502-8000-FB
10000 g	1	NSB502-10000-FB
12000 g	1	NSB502-12000-FB

BAM/ZBF/003/21

Non-Sparking Machinist's Hammers with Aluminium Bronze Head and Fibreglass Handle



NS504-FB

Weight	Quantity	Model
100 g	1	NS504-100-FB
200 g	1	NS504-200-FB
300 g	1	NS504-300-FB
500 g	1	NS504-500-FB
800 g	1	NS504-800-FB
1000 g	1	NS504-1000-FB
1500 g	1	NS504-1500-FB
2000 g	1	NS504-2000-FB

BAM/ZBF/002/21

Non-Sparking Machinist's Hammers with Copper Beryllium Head and Fibreglass Handle



NSB504-FB

Weight	Quantity	Model
100 g	1	NSB504-100-FB
200 g	1	NSB504-200-FB
300 g	1	NSB504-300-FB
500 g	1	NSB504-500-FB
800 g	1	NSB504-800-FB
1000 g	1	NSB504-1000-FB
1500 g	1	NSB504-1500-FB
2000 g	1	NSB504-2000-FB

BAM/ZBF/003/21

Non-Sparking Ball Pein Hammers with Aluminium Bronze Head and Wooden Handle



NS506

Weight	Quantity	Model
340 g	1	NS506-300
450 g	1	NS506-450
670 g	1	NS506-700
910 g	1	NS506-900

BAM/ZBF/002/21

Non-Sparking Ball Pein Hammers with Copper Beryllium Head and Wooden Handle



NSB506

Weight	Quantity	Model
300 g	1	NSB506-300
450 g	1	NSB506-450
680 g	1	NSB506-700
910 g	1	NSB506-900

BAM/ZBF/003/21



Non-Sparking Ball Pein Hammers with Aluminium Bronze Head and Fibreglass Handle



NS506-FB

Weight	Part Number
310 g	1 NS506-300-FB
470 g	1 NS506-450-FB
700 g	1 NS506-700-FB
910 g	1 NS506-900-FB

BAM/ZBF/002/21

Non-Sparking Ball Pein Hammers with Copper Beryllium Head and Fibreglass Handle



NSB506-FB

Weight	Part Number
300 g	1 NSB506-300-FB
450 g	1 NSB506-450-FB
680 g	1 NSB506-700-FB
900 g	1 NSB506-900-FB

BAM/ZBF/003/21

Non-Sparking Claw Hammers with Aluminium Bronze Head and Fibreglass Handle



NS508-FB

Weight	Part Number
500 g	1 NS508-500-FB
700 g	1 NS508-700-FB

BAM/ZBF/002/21

Non-Sparking Claw Hammers with Copper Beryllium Head and Fibreglass Handle



NSB508-FB

Weight	Part Number
500 g	1 NSB508-500-FB
700 g	1 NSB508-700-FB

BAM/ZBF/003/21

Non-Sparking Chipping Hammers with Aluminium Bronze Head and Fibreglass Handle



NS512-FB

Weight	Part Number
230 g	1 NS512-200-FB
400 g	1 NS512-400-FB
640 g	1 NS512-600-FB
970 g	1 NS512-900-FB

BAM/ZBF/002/21

Non-Sparking Chipping Hammers with Copper Beryllium Head and Fibreglass Handle



NSB512-FB

Weight	Part Number
200 g	1 NSB512-200-FB
400 g	1 NSB512-400-FB
600 g	1 NSB512-600-FB
900 g	1 NSB512-900-FB

BAM/ZBF/003/21

Non-Sparking Wedges Aluminium Bronze



NS600

Length	Part Number
80 mm	1 NS600-80-13
100 mm	1 NS600-100-50
135 mm	1 NS600-135-50
150 mm	1 NS600-150-25
150 mm	1 NS600-150-30
150 mm	1 NS600-150-40
150 mm	1 NS600-150-50
180 mm	1 NS600-180-13
180 mm	1 NS600-180-32
180 mm	1 NS600-180-50
200 mm	1 NS600-200-20
200 mm	1 NS600-200-30
200 mm	1 NS600-200-40
200 mm	1 NS600-200-50
230 mm	1 NS600-230-40
250 mm	1 NS600-250-40
300 mm	1 NS600-300-50

BAM/ZBF/002/21

Non-Sparking Wedges Copper Beryllium



NSB600

Length	Part Number
80 mm	1 NSB600-80-13
100 mm	1 NSB600-100-50
135 mm	1 NSB600-135-50
150 mm	1 NSB600-150-25
150 mm	1 NSB600-150-30
150 mm	1 NSB600-150-40
150 mm	1 NSB600-150-50
180 mm	1 NSB600-180-13
180 mm	1 NSB600-180-32
180 mm	1 NSB600-180-50
200 mm	1 NSB600-200-20
200 mm	1 NSB600-200-30
200 mm	1 NSB600-200-40
200 mm	1 NSB600-200-50
230 mm	1 NSB600-230-40
250 mm	1 NSB600-250-40
300 mm	1 NSB600-300-50

BAM/ZBF/003/21

Non-Sparking Wrecking Bars Aluminium
Bronze



NS602

Ø	L	Icon 1	Icon 2
16 mm	460 mm	1	NS602-460
20 mm	600 mm	1	NS602-600
22 mm	760 mm	1	NS602-760
22 mm	935 mm	1	NS602-900

BAM/ZBF/002/21

Non-Sparking Cross Cutting Chisels
Copper Beryllium



NSB604

L	Icon 1	Icon 2
140 mm	1	NSB604-150
200 mm	1	NSB604-200
300 mm	1	NSB604-300

BAM/ZBF/003/21

Non-Sparking Centre Punches Aluminium
Bronze



NS608

L	Icon 1	Icon 2
100 mm	1	NS608-100

BAM/ZBF/002/21

Non-Sparking Wrecking Bars Copper
Beryllium



NSB6028

Ø	L	Icon 1	Icon 2
16 mm	460 mm	1	NSB602-460
20 mm	600 mm	1	NSB602-600
22 mm	760 mm	1	NSB602-760
22 mm	920 mm	1	NSB602-900

BAM/ZBF/003/21

Non-Sparking Flat Chisels Aluminium
Bronze



NS606

L	Icon 1	Icon 2
150 mm	1	NS606-150
200 mm	1	NS606-200
250 mm	1	NS606-250
300 mm	1	NS606-300
400 mm	1	NS606-400

BAM/ZBF/002/21

Non-Sparking Centre Punches Copper
Beryllium



NSB608

L	Icon 1	Icon 2
100 mm	1	NSB608-100

BAM/ZBF/003/21

Non-Sparking Cross Cutting Chisels
Aluminium Bronze



NS604

L	Icon 1	Icon 2
140 mm	1	NS604-150
200 mm	1	NS604-200
300 mm	1	NS604-300

BAM/ZBF/002/21

Non-Sparking Flat Chisels Copper
Beryllium



NSB606

L	Icon 1	Icon 2
150 mm	1	NSB606-150
200 mm	1	NSB606-200
250 mm	1	NSB606-250
300 mm	1	NSB606-300
400 mm	1	NSB606-400

BAM/ZBF/003/21

SCRAPERS

Non-Sparking Angled Scrapers Aluminium
Bronze



NS700

Ø	L	Icon 1	Icon 2
45 mm	300 mm	1	NS700-300

BAM/ZBF/002/21



Non-Sparking Angled Scrapers Copper
Beryllium



NSB700

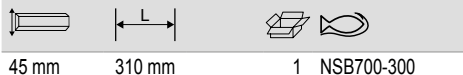

45 mm 310 mm 1 NSB700-300

BAM/ZBF/003/21

Non-Sparking Long Blade Scrapers
Aluminium Bronze



NS704

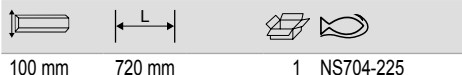

100 mm 720 mm 1 NS704-225

BAM/ZBF/002/21

Non-Sparking Flexible Scrapers Copper
Beryllium



NSB706



50 mm 200 mm 1 NSB706-50
80 mm 200 mm 1 NSB706-80

BAM/ZBF/003/21

Non-Sparking Flat Scrapers Aluminium
Bronze



NS702



30 mm 325 mm 1 NS702-200

BAM/ZBF/002/21

Non-Sparking Long Blade Scrapers
Copper Beryllium



NSB704

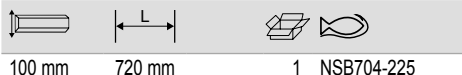

100 mm 720 mm 1 NSB704-225

BAM/ZBF/003/21

Non-Sparking Three-Square Scrapers
Aluminium Bronze



NS708



440 mm 1 NS708-360

BAM/ZBF/002/21

Non-Sparking Flat Scrapers Copper
Beryllium



NSB702

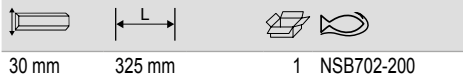

30 mm 325 mm 1 NSB702-200

BAM/ZBF/003/21

Non-Sparking Flexible Scrapers Aluminium
Bronze



NS706



50 mm 200 mm 1 NS706-50
80 mm 200 mm 1 NS706-80

BAM/ZBF/002/21

Non-Sparking Three-Square Scrapers
Copper Beryllium



NSB708



450 mm 1 NSB708-360

BAM/ZBF/003/21

Non-Sparking Triangular Ship Scrapers
Aluminium Bronze



NS710

470 mm	1	NS710-450

BAM/ZBF/002/21

Non-Sparking Triangular Ship Scrapers
Copper Beryllium



NSB710

470 mm	1	NSB710-450

BAM/ZBF/003/21

DIGGING TOOLS

Non-Sparking Pickaxes Aluminium Bronze



NS800

910 mm	1	NS800-1100
910 mm	1	NS800-1700
965 mm	1	NS800-2000

BAM/ZBF/002/21

Non-Sparking Pickaxes Copper Beryllium



NSB800

910 mm	2000 g	1	NSB800-1100
910 mm	2800 g	1	NSB800-1700
910 mm	3200 g	1	NSB800-2000

BAM/ZBF/003/21

Non-Sparking Round Shovels Aluminium
Bronze



NS802

1370 mm	1	NS802-290

BAM/ZBF/002/21

Non-Sparking Round Shovels Copper
Beryllium



NSB802

1450 mm	1	NSB802-290

BAM/ZBF/003/21

Non-Sparking Hand Brushes Brass



NS804

290 mm	1	NS804-290

BAM/ZBF/002/21

EXTRACTORS & PULLERS

Non-Sparking 3-Jaws Reversible Pullers
Aluminium Bronze



NS810

50-100 mm	105 mm	1	NS810-100
60-150 mm	175 mm	1	NS810-150
70-200 mm	250 mm	1	NS810-200
80-350 mm	320 mm	1	NS810-350

BAM/ZBF/002/21

Non-Sparking 3-Jaws Reversible Pullers
Copper Beryllium



NSB810

50-100 mm	105 mm	1	NSB810-100
60-150 mm	175 mm	1	NSB810-150
70-200 mm	250 mm	1	NSB810-200
80-350 mm	320 mm	1	NSB810-350

BAM/ZBF/003/21



TORQUE TOOLS

Non-Sparking Mechanical Adjustable Torque Click Wrenches with Window Scale and Fixed Ratchet Head in Aluminium Bronze



NS041



1/4"	5-25 N·m	1	NS041-8-25
3/8"	10-50 N·m	1	NS041-12-50
1/2"	20-100 N·m	1	NS041-16-100
1/2"	40-200 N·m	1	NS041-16-200
1/2"	60-260 N·m	1	NS041-16-260
3/4"	150-670 N·m	1	NS041-24-670
1"	200-900 N·m	1	NS041-32-900

BAM/ZBF/002/21

Non-Sparking Mechanical Adjustable Torque Click Wrenches with Window Scale and Fixed Ratchet Head in Copper Beryllium



NSB041



1/4"	5-25 N·m	1	NSB041-8-25
3/8"	10-50 N·m	1	NSB041-12-50
1/2"	20-100 N·m	1	NSB041-16-100
1/2"	40-200 N·m	1	NSB041-16-200
1/2"	60-260 N·m	1	NSB041-16-260
3/4"	150-670 N·m	1	NSB041-24-670
1"	200-900 N·m	1	NSB041-32-900

BAM/ZBF/003/21



Stainless Steel Tools



WRENCHES

Stainless Steel Central Nut Adjustable Wrenches



SS001

Length	Width	Weight	Part No.
100mm/4"	13 mm	1	SS001-100
150mm/6"	18 mm	1	SS001-150
200mm/8"	24 mm	1	SS001-200
250mm/10"	30 mm	1	SS001-250
300mm/12"	36 mm	1	SS001-300
375mm/15"	46 mm	1	SS001-375
450mm/18"	55 mm	1	SS001-450
600mm/24"	60 mm	1	SS001-600

Stainless Steel Metric Offset Combination Wrenches



SS002

Length	Width	Weight	Part No.
7 in		1	SS002-7
6 mm		1	SS002-6
8 mm		1	SS002-8
10 mm		1	SS002-10
11 mm		1	SS002-11
12 mm		1	SS002-12
13 mm		1	SS002-13
14 mm		1	SS002-14
15 mm		1	SS002-15
16 mm		1	SS002-16
17 mm		1	SS002-17
19 mm		1	SS002-19
21 mm		1	SS002-21
22 mm		1	SS002-22
24 mm		1	SS002-24
27 mm		1	SS002-27
32 mm		1	SS002-32

Stainless Steel Metric Combination Wrench Set - 6 Pcs



SS002-6-2

Length	Weight	Part No.
6	710 g	1 SS002-6-2

SS002-8, SS002-10, SS002-12, SS002-14, SS002-17, SS002-19

Stainless Steel Metric Combination Wrench Set - 9 Pcs



SS002-9-2

Length	Weight	Part No.
9	924 g	1 SS002-9-2

SS002-8, SS002-10, SS002-11, SS002-12, SS002-13, SS002-14, SS002-15, SS002-17, SS002-19

Stainless Steel Imperial Combination Wrenches



SS003

Length	Weight	Part No.
1/4 in	105 mm	1 SS003-8
5/16 in	120 mm	1 SS003-10
11/32 in	135 mm	1 SS003-11
3/8 in	135 mm	1 SS003-12
7/16 in	150 mm	1 SS003-14
1/2 in	175 mm	1 SS003-16
9/16 in	175 mm	1 SS003-18
5/8 in	195 mm	1 SS003-20
11/16 in	195 mm	1 SS003-22

Length	Weight	Part No.
3/4 in	215 mm	1 SS003-24
25/32 in	215 mm	1 SS003-25
13/16 in	245 mm	1 SS003-26
7/8 in	245 mm	1 SS003-28
15/16 in	265 mm	1 SS003-30

Stainless Steel Metric Double Ring End Offset Wrenches



SS011

Length	Weight	Part No.
5.5*7 mm	180 mm	1 SS011-0507
6*7 mm	180 mm	1 SS011-0607
8*9 mm	190 mm	1 SS011-0809
8*10 mm	190 mm	1 SS011-0810
9*11 mm	215 mm	1 SS011-0911
10*12 mm	215 mm	1 SS011-1012
12*14 mm	225 mm	1 SS011-1214
14*17 mm	255 mm	1 SS011-1417
16*18 mm	280 mm	1 SS011-1618
17*19 mm	280 mm	1 SS011-1719
17*22 mm	300 mm	1 SS011-1722
22*24 mm	330 mm	1 SS011-2224
24*27 mm	340 mm	1 SS011-2427
24*30 mm	350 mm	1 SS011-2430
30*32 mm	370 mm	1 SS011-3032

Stainless steel double ring end offset wrenches sets, mm. 9 pieces

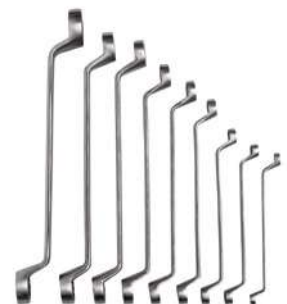

SS011-9-3

Length	Weight	Part No.
9	2470 g	1 SS011-9-3

SS011-0810, SS011-1012, SS011-1214, SS011-1417, SS011-1719, SS011-1722, SS011-2224, SS011-2427, SS011-3032

Stainless steel double ring end offset wrenches sets, mm. 11 pieces



SS011-11-3

11	3100 g	1	SS011-11-3

SS011-0810, SS011-0911, SS011-1012, SS011-1214, SS011-1417, SS011-1719, SS011-1722, SS011-2224, SS011-2427, SS011-2430, SS011-3032

SOCKETS & RATCHETS

1/4" Square Drive Stainless Steel Sockets with Metric Hex Profile



SS210

4 mm	25 mm	1	SS210-4
4.5 mm	25 mm	1	SS210-4.5
5 mm	25 mm	1	SS210-5
5.5 mm	25 mm	1	SS210-5.5
6 mm	25 mm	1	SS210-6
7 mm	25 mm	1	SS210-7
8 mm	25 mm	1	SS210-8
9 mm	25 mm	1	SS210-9
10 mm	25 mm	1	SS210-10
11 mm	25 mm	1	SS210-11
12 mm	26 mm	1	SS210-12
13 mm	26 mm	1	SS210-13
14 mm	26 mm	1	SS210-14

1/2" Square Drive Stainless Steel Sockets with Metric Hex Profile



SS220

8 mm	40 mm	1	SS220-8
9 mm	40 mm	1	SS220-9
10 mm	40 mm	1	SS220-10

11 mm	40 mm	1	SS220-11
12 mm	40 mm	1	SS220-12
13 mm	40 mm	1	SS220-13
14 mm	40 mm	1	SS220-14
15 mm	40 mm	1	SS220-15
16 mm	40 mm	1	SS220-16
17 mm	40 mm	1	SS220-17
18 mm	42 mm	1	SS220-18
19 mm	42 mm	1	SS220-19
20 mm	42 mm	1	SS220-20
21 mm	43 mm	1	SS220-21
22 mm	43 mm	1	SS220-22
23 mm	43 mm	1	SS220-23
24 mm	43 mm	1	SS220-24
25 mm	43 mm	1	SS220-25
26 mm	43 mm	1	SS220-26
27 mm	46 mm	1	SS220-27
28 mm	46 mm	1	SS220-28
29 mm	46 mm	1	SS220-29
30 mm	46 mm	1	SS220-30
31 mm	46 mm	1	SS220-31
32 mm	46 mm	1	SS220-32

3/4" Square Drive Stainless Steel Sockets with Metric Hex Profile



SS224

17 mm	50 mm	1	SS224-17
19 mm	50 mm	1	SS224-19
22 mm	55 mm	1	SS224-22
24 mm	55 mm	1	SS224-24
27 mm	55 mm	1	SS224-27
30 mm	60 mm	1	SS224-30
32 mm	60 mm	1	SS224-32
34 mm	60 mm	1	SS224-34
36 mm	60 mm	1	SS224-36
41 mm	65 mm	1	SS224-41
46 mm	65 mm	1	SS224-46
50 mm	70 mm	1	SS224-50
55 mm	75 mm	1	SS224-55
60 mm	75 mm	1	SS224-60
65 mm	80 mm	1	SS224-65

Stainless Steel Extensions



SS234

100 mm	1/2"	1	SS234-16-100
200 mm	1/2"	1	SS234-16-200
250 mm	1/2"	1	SS234-16-250

100 mm	3/4"	1	SS234-24-100
200 mm	3/4"	1	SS234-24-200
250 mm	3/4"	1	SS234-24-250

Stainless Steel Universal Joints



SS236

56 mm	1/4"	1	SS236-08-80
80 mm	1/2"	1	SS236-16-80
110 mm	3/4"	1	SS236-24-110

Stainless Steel Sliding T-Handles



SS238

250 mm	1/4"	1	SS238-08-250
250 mm	1/2"	1	SS238-16-250
350 mm	3/4"	1	SS238-24-350

Stainless Steel Rotary Speed Handles



SS243

300 mm	1/4"	1	SS243-08
390 mm	1/2"	1	SS243-16
450 mm	3/4"	1	SS243-24



Stainless Steel Reversible Ratchets



SS242

Length	Hex Size	Qty	Part No.
200 mm	1/4"	1	SS242-08-200
245 mm	1/2"	1	SS242-16-245
320 mm	3/4"	1	SS242-24-320

SCREWDRIVERS

ERGO™ Stainless Steel Straight Tipped Slotted Screwdrivers with 3-Component Handle 0.5 mm-1.2 mm



BE-8020i - BE-8252i

Hex Size	Length	Qty	Part No.
3.0 mm	60 mm	5	BE-8020i
3.5 mm	75 mm	5	BE-8030i
4.0 mm	100 mm	5	BE-8040i
5.5 mm	125 mm	5	BE-8241i
6.5 mm	150 mm	5	BE-8252i

ERGO™ Stainless Steel Phillips Screwdrivers with 3-Component Handle PH0-PH4



BE-8600i - BE-8623i

Hex Size	Length	Qty	Part No.
PH 0	60 mm	5	BE-8600i
PH 1	75 mm	5	BE-8610i
PH 2	100 mm	5	BE-8620i
PH 3	150 mm	5	BE-8623i

ERGO™ Stainless Steel Pozidriv Screwdrivers with 3-Component Handle PZ0-PZ4



BE-8800i - BE-8823i

Hex Size	Length	Qty	Part No.
PZ 0	60 mm	5	BE-8800i
PZ 1	75 mm	5	BE-8810i
PZ 2	100 mm	5	BE-8820i
PZ 3	150 mm	5	BE-8823i

ERGO™ Stainless Steel TORX® Screwdrivers with 3-Component Handle T10-T25



BE-8910i - BE-8925i

Hex Size	Length	Qty	Part No.
T 10	75 mm	5	BE-8910i
T 15	100 mm	5	BE-8915i
T 20	100 mm	5	BE-8920i
T 25	125 mm	5	BE-8925i

ERGO™ Stainless Steel Slotted/Phillips Screwdriver Set - 6 Pcs



BE-9881i

Hex Size	Qty	Part No.
6	1	BE-9881i

BE-8020i, BE-8040i, BE-8241i, BE-8252i

BE-8610i, BE-8620i

ERGO™ Stainless Steel Slotted/Pozidriv Screwdriver Set - 6 Pcs



BE-9882i

Hex Size	Qty	Part No.
6	1	BE-9882i

BE-8020i, BE-8040i, BE-8241i, BE-8252i

BE-8810i, BE-8820i

L-KEYS

Metric Stainless Steel L-Keys with Long Ball End for Hex Screws



SS324

Hex Size	Length	Qty	Part No.
1.5 mm	80 mm	2	SS324-1.5
2 mm	85 mm	2	SS324-2
2.5 mm	93 mm	2	SS324-2.5
3 mm	103 mm	1	SS324-3
4 mm	110 mm	1	SS324-4
5 mm	123 mm	1	SS324-5
6 mm	146 mm	1	SS324-6
8 mm	168 mm	1	SS324-8
10 mm	180 mm	1	SS324-10

Metric Stainless Steel L-Key Set with Long Ball End for Hex Screws - 9 Pcs



BE-9770i

Hex Size	Qty	Part No.
9	20	BE-9770i

SS324-1.5, SS324-2, SS324-2.5,
SS324-3, SS324-4, SS324-5, SS324-6,
SS324-8, SS324-10

Imperial Stainless Steel L-Keys with Long
Ball End for Hex Screws



SS325

Size	Length (mm)	Quantity	Part Number
5/64" in	85 mm	2	SS325-2.5
7/64" in	96 mm	2	SS325-3.5
1/8" in	101 mm	1	SS325-4
9/64" in	106 mm	1	SS325-4.5
5/32" in	111 mm	1	SS325-5
3/16" in	121 mm	1	SS325-6
7/32" in	132 mm	1	SS325-7
1/4" in	142 mm	1	SS325-8
5/16" in	163 mm	1	SS325-10
3/8" in	183 mm	1	SS325-12
3/32" in	90 mm	2	SS325-3

Imperial Stainless Steel L-Key Set with
Long Ball End for Hex Screws - 13 Pcs



BE-9786i

Quantity	Sizes	Part Number
13	0.05; 1/16; 5/64; 3/32; 7/64; 1/8; 9/64; 5/32; 3/16; 7/32; 1/4; 5/16; 3/8; in	1 BE-9786i

SS325-2.5, SS325-3, SS325-3.5,
SS325-4, SS325-4.5, SS325-5, SS325-
6, SS325-7, SS325-8, SS325-10,
SS325-12

SCREWDRIVER BITS

1/4" Stainless Steel Torsion Screwdriver
Bits for Phillips Head Screws 25 mm



65I/PH

Quantity	Size	Part Number
10	1	1 65I/PH1
2	1	1 65I/PH1-2P
10	2	1 65I/PH2
2	2	1 65I/PH2-2P
10	3	1 65I/PH3
2	3	1 65I/PH3-2P

1/4" Stainless Steel Torsion Screwdriver
Bits for Pozidriv Head Screws 25 mm



65I/PZ

Quantity	Size	Part Number
10	1	1 65I/PZ1
2	1	1 65I/PZ1-2P
10	2	1 65I/PZ2
2	2	1 65I/PZ2-2P
10	3	1 65I/PZ3
2	3	1 65I/PZ3-2P

1/4" Stainless Steel Torsion Screwdriver
Bits for TORX® Head Screws 25 mm



65I/T

Quantity	Size	Part Number
5	T15	1 65I/T15
5	T25	1 65I/T25
5	T30	1 65I/T30
5	T40	1 65I/T40
2	T40	1 65I/T40-2P

1/4" Hex Universal Bit Holders with
Retaining Ring 75 mm



KSR753

Quantity	Size	Part Number
1	1/4 in	1 KSR753-1P
5	1/4 in	1 KSR753

1/4" Stainless Steel Bit Set for Phillips/
Pozidriv/TORX® Screws - 7 Pcs



65I/7

Dimensions	Quantity	Part Number
22 x 65 x 75 mm	1	65I/7-1

65I/PH2		
65I/PZ2		
65I/T15, 65I/T20, 65I/T25, 65I/T30		

PLIERS

Stainless Steel Combination Pliers with
PVC Coated Handles



SS400

Length	Quantity	Part Number
155 mm	1	SS400-160
175 mm	1	SS400-180
200 mm	1	SS400-200



Stainless Steel Diagonal Cutting Pliers with PVC Coated Handles



SS402

150 mm	1 SS402-160
195 mm	1 SS402-200

Stainless Steel Slip Joint Pliers with 2-Position and PVC Coated Handles



SS412

200 mm	1 SS412-200

Stainless Steel Snipe Nose Pliers with PVC Coated Handles



SS406

150 mm	1 SS406-160
175 mm	1 SS406-200

Stainless Steel Box Joint Pliers with PVC Coated Handles



SS410

250 mm	1 SS410-250
300 mm	1 SS410-300

Stainless Steel Locking Pliers



SS415

255 mm	1 SS415-225

HAMMERS

Stainless Steel Ball Pein Hammers with Fibreglass Handle



SS506

200 g	1 SS506-200-FB
300 g	1 SS506-300-FB
450 g	1 SS506-500-FB
680 g	1 SS506-700-FB
900 g	1 SS506-900-FB
1100 g	1 SS506-1100-FB

Stainless Steel Sledge Hammers with Fibreglass Handle



SS502

1000 g	1 SS502-1000-FB
1500 g	1 SS502-1500-FB
2000 g	1 SS502-2000-FB
2500 g	1 SS502-2500-FB
3000 g	1 SS502-3000-FB
3600 g	1 SS502-3600-FB

PUNCHES & COLD CHISELS

Stainless Steel Tapered Pry Bars



SS603

500 mm	1 SS603-15-500
500 mm	1 SS603-19-500
500 mm	1 SS603-20-500
500 mm	1 SS603-23-500
800 mm	1 SS603-23-800
600 mm	1 SS603-25-600
1000 mm	1 SS603-30-1000

Stainless Steel 55° Flat Chisel with Oval Form



SS610

160 mm	1 SS610-16-160
200 mm	1 SS610-18-200
300 mm	1 SS610-24-300
400 mm	1 SS610-25-400
500 mm	1 SS610-30-500

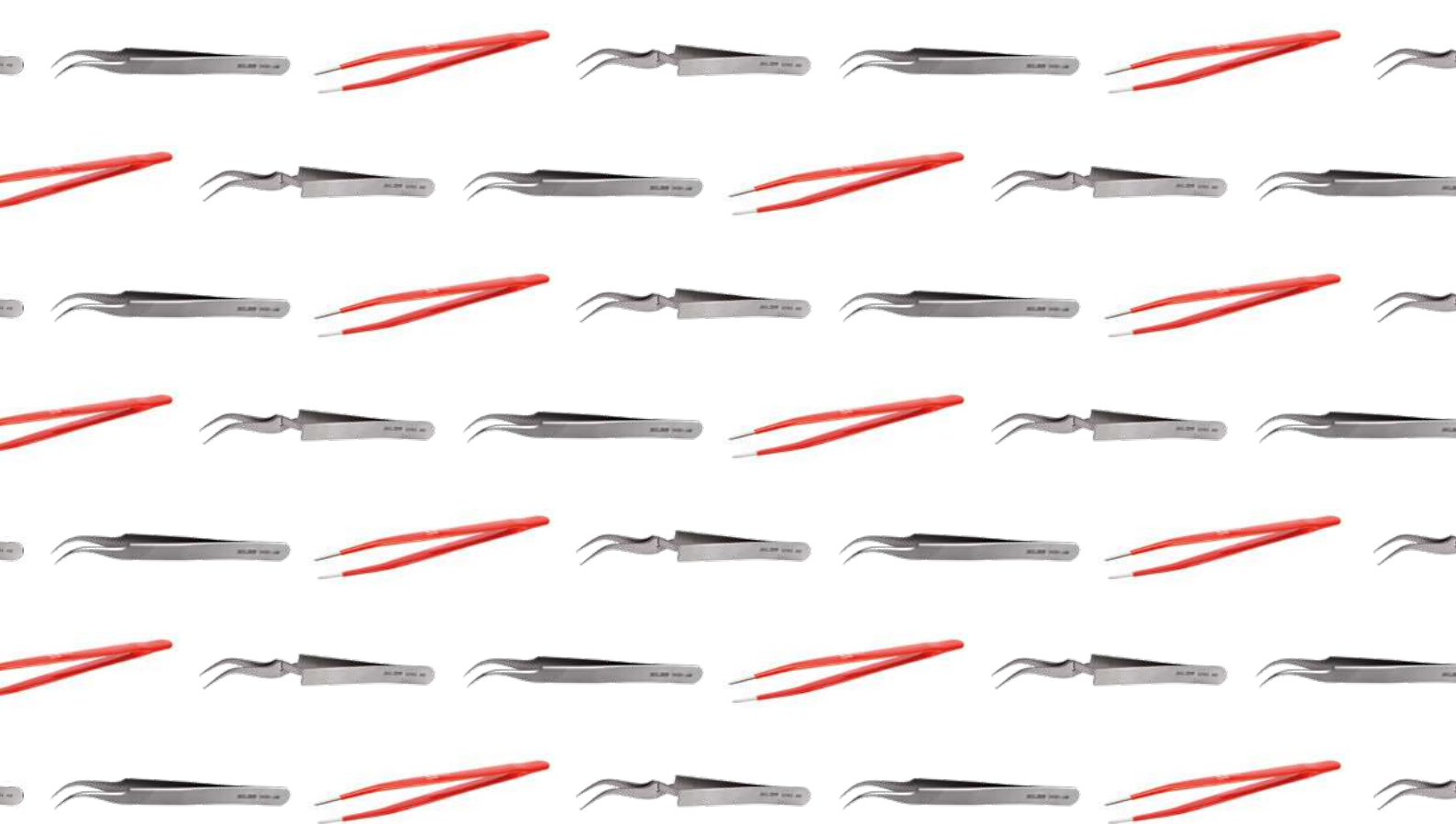

Tweezers & Electronics Specialty Tools



TWEEZERS

General Purpose Tweezers with Serrated Tips



5468



112 mm



5 5468-112

General Purpose Tweezers with Polished/
PVC Coated Finish 127 mm



5469



127 mm
127 mm
127 mm



5 5469-127
5 5469 R
5 5469 I

General Purpose Tweezers with Polished/
PVC Coated Finish 120 mm



5469B



120 mm
120 mm



5 5469 B
5 5469 BI

General Pointed Tweezers with Polished
and Nickel Plated Finish



5479



130 mm



5 5479-130

General Purpose Tweezers with Polished
and Nickel Plated/Polished/PVC Coated
Finish



5471F



120 mm
145 mm
200 mm
250 mm
300 mm
120 mm
200 mm
120 mm
145 mm



5 5471 F-120
5 5471 F-145
5 5471 F-200
5 5471 F-250
5 5471 F-300
5 5471 FI-120
5 5471 FI-200
5 5471 FR-120
5 5471 FR-145

General Purpose Tweezers with Polished
and Nickel Plated/Polished Finish



5475R/5475K



150 mm
100 mm



5 5475 R
5 5475 K

General Purpose Tweezers with Polished
and Nickel Plated/PVC Coated Finish



5516



150 mm
150 mm



5 5516
5 5516 I

Non-Magnetic Titanium General Tweezers
for Fine and Ultra-Fine Assembly Work
110 mm



5465AMT



110 mm



5 5465 AMT

General Pointed Tweezers with Polished
and Nickel Plated/PVC Coated Finish



5517



155 mm
155 mm



5 5517
5 5517 I

General Reverse Action Tweezers with
Polished and Nickel Plated Finish



5518



155 mm



5 5518

SMD Tweezers for Handling and
Positioning SOT Packages



5540AM



120 mm



5 5540 AM

SMD Tweezers for Positioning All SOT Packages Vertically



5541AM



120 mm



5 5541 AM

SMD Tweezers for Positioning and Soldering 1 mm Components at 45° Angle



5547AM



120 mm



5 5547 AM

Electronics Tweezers for Easy Manipulation of Components in Confined Areas



5490AM



115 mm



5 5490 AM

SMD Tweezers for Handling and Positioning 2/3 Lead SOT Packages at 45° Angle



5544AM



115 mm



5 5544 AM

SMD Tweezers for Positioning 5 mm Monolithic Chip Capacitors



5549AM



120 mm



5 5549 AM

Assembly Tweezers for Diagonal Inserting and Desoldering Circuit Board Levels with 6 mm Jaw



5573



145 mm



5 5573-145

SMD Tweezers for Positioning Flat Devices at 60° Angle



5545AM



120 mm



5 5545 AM

Electronics Tweezers for Holding Smallest Components



5488AM



115 mm



5 5488 AM

Assembly Tweezers for Inserting and Desoldering Horizontal Components with 4 mm Jaw



5578



122 mm



5 5578-115

SMD Tweezers for Positioning and Soldering 1 mm Components



5546AM



120 mm



5 5546 AM

Electronics Tweezers for Picking Up Flat Lying Components



5489AM



115 mm



5 5489 AM

Assembly Tweezers for Inserting and Desoldering Horizontal Components



5579



115 mm



5 5579-115



SMD Tweezers for Positioning 5 mm Monolithic Chip at 60° Angle



5588AM

120 mm 5 5588 AM

SMD Tweezers with Grooved Tips and 30° Bent Angle



5589AM

120 mm 5 5589 AM

SMD Tweezers for Vertical Positioning of Cylindrical Devices Ø1 mm or More



5590AM

120 mm 5 5590 AM

Stainless Steel SMD Tweezers Set - 5 Pcs



5568/5

100 g 1 5568/5

- 5489 AM
- 5583 AM
- 5589 AM
- 5584 AM
- 5546 AM

Watchmaker's Straight Tweezers with Polished Finish 120 mm



5463

120 mm 5 5463-120
120 mm 5 5463 R

Jeweller's Tweezers with Polished and Nickel Plated/PVC Coated Finish



5470

120 mm 5 5470-120

Heat Absorbing Tweezers for Soldering on Semiconductors



5577

145 mm 5 5577-145

Watchmaker's Straight Tweezers with Polished Finish 105 mm



5465

105 mm 5 5465 R

Cutting Tweezers for Copper Wires



5493

115 mm 5 5493-115

Soldering Tweezers with Vulcanised Fibre Hand Protection



5476H

160 mm 5 5476 H

SOLDERING TOOLS

Instant Heat Double Insulated Soldering Guns



3250



100 W	400 °C	1	325001000
		1	3250010SH

3250010SH: Spare tip

Heavy-Duty Soldering Irons with Euro Plug and Soldering Stand 30 W/40 W/80 W



322500



30 W	370 °C	1	322500300
40 W	375 °C	1	322500500
80 W	380 °C	1	322500800

Electronic Soldering Irons with Euro Plug and Earth Connection 18 W/25 W



32600



18 W	390 °C	1	326000200
25 W	420 °C	1	326000300

Temperature Controlled Soldering Irons with Euro Plug and Soldering Stand



3270



50 W	200-500 °C	1	327020500
------	------------	---	-----------

Spare Tips for Heavy-Duty Soldering Iron with Straight and Angled Version



3225



1.5 x 2.5 mm	1	322510300
1.5 x 2.5 mm	1	322510400
2 x 3 mm	1	322510500
2 x 3 mm	1	322510600
2.5 x 5 mm	1	322510700
2.5 x 5 mm	1	322510800

Spare Tips for Electronic Soldering Guns



326010



5 g	1	326010200
5 g	1	326020200
5 g	1	326030200

Spare Tips for 3270 Temperature Controlled Soldering Irons



327020500-SH



0,5mm	1	327020500-SH1
2mm	1	327020500-SH2
3mm	1	327020500-SH3
4mm	1	327020500-SH4

Lead-Free Solders 0.8 mm



3290



2000 mm	1	329000330
4000 mm	1	329000500

FINE MECHANICAL

Miniature Awls/Hooks/Picks Tool Set 150 mm-250 mm



2633/



17 x 80 x 150 mm	12	2633/S4
12 x 12 x 275 mm	12	2633L/S4



Double End Wires and Spring Hooks with Knurled Hexagon Handle



5418



145 mm



1 5418

Adjusting Screwdrivers with Guide Sleeve and Plastic Handle



5550



140 mm
140 mm



10 5550-3.2
10 5550-4.5

Lacquer Stripping Tweezers with Plastic Grips



2530-32/2530-40



130 mm



5 2530-40

Hook Set 105 mm - 6 Pcs



5419/6T



5 x 78 x 110 mm



1 5419/6T

Tuning and Trimming Tools



5551-5554



220 mm
205 mm
195 mm
180 mm



1 5551
1 5552
1 5553
1 5554

Carbon Scrapers with Plastic Handle



2487



210 mm



12 2487

3-Square Scrapers with Nickel Plated Handle



3524



24 g
5 g



1 3524
5 3524L-K

ERGO™ O-Ring Levers for Desoldering



ergo



BE-3529



197 mm



5 BE-3529

Tuning and Trimming Tools Set



5600/4



75 g



1 5600/4

3-Square Machinist's Scrapers with Plastic Handle



3525HB



168 mm



5 3525HB

5551, 5552, 5553, 5554



Measuring & Layout



MEASURING TAPES

Double-Sided Measuring Tapes with Rubber Grip



MTS

Length	Blade Width	Quantity	Model
5 m	25 mm	6	MTS-5-25
5 m	25 mm	6	MTS-5-25-E
8 m	25 mm	6	MTS-8-25
8 m	25 mm	6	MTS-8-25-E

Short Measuring Tapes with Positive Locking Button



MTG

Length	Blade Width	Quantity	Model
3 m	16 mm	12	MTG-3-16
3 m	16 mm	12	MTG-3-16-E
5 m	19 mm	12	MTG-5-19
5 m	19 mm	12	MTG-5-19-E
8 m	25 mm	4	MTG-8-25
8 m	25 mm	4	MTG-8-25-E

COMPACT 3 M x 13 mm METRIC MEASURING TAPE



MT-TS-3

Length	Blade Width	Quantity	Model
3 m	13 mm	12	MT-TS-3

Short Measuring Tapes with Rubber Grip



MTB

Length	Blade Width	Quantity	Model
3 m	16 mm	6	MTB-3-16
3 m	16 mm	6	MTB-3-16-M
3 m	16 mm	6	MTB-3-16-M-E
5 m	25 mm	6	MTB-5-25
5 m	25 mm	6	MTB-5-25-M
5 m	25 mm	6	MTB-5-25-M-E
8 m	25 mm	6	MTB-8-25
8 m	25 mm	6	MTB-8-25-M
8 m	25 mm	6	MTB-8-25-M-E

Short Measuring Tapes with ABS Grip Compact Class-I



MTC_C1

Length	Blade Width	Quantity	Model
3 m	13 mm	6	MTC-3-13-C1
5 m	16 mm	6	MTC-5-16-C1

Short Measuring Tapes with Steel Blade



1162N

Length	Blade Width	Quantity	Model
3 m	13 mm	1	1162N-1/2

Short Measuring Tapes with Rubber Grip Class-I



MTB_C1

Length	Blade Width	Quantity	Model
5 m	25 mm	6	MTB-5-25-C1

Short Measuring Tapes with ABS Grip Compact Class-II



MTC_C2

Length	Blade Width	Quantity	Model
3 m	13 mm	6	MTC-3-13
5 m	16 mm	6	MTC-5-16

Adhesive Steel Bench Measuring Tapes



BT

Length	Blade Width	Quantity	Model
3 m	13 mm	12	BTR-3-13
6 m	13 mm	12	BTR-6-13
3 m	13 mm	12	BTL-3-13
6 m	13 mm	12	BTL-6-13

Long Measuring Tapes with Steel Blade



LTG

L	Blade Width	Quantity	Model
10 m	10 mm	6	LTG-10
20 m	10 mm	6	LTG-20
30 m	10 mm	6	LTG-30

Long Measuring Tapes with Nylon Coated Blade and Open Case



LTS

L	Blade Width	Quantity	Model
30 m	13 mm	5	LTS-30
30 m	13 mm	5	LTS-30-E
50 m	13 mm	5	LTS-50
50 m	13 mm	5	LTS-50-E
100 m	13 mm	5	LTS-100
100 m	13 mm	5	LTS-100-E

Long Measuring Tapes with Nylon Coated Blade



LTB

L	Blade Width	Quantity	Model
10 m	13 mm	6	LTB-10
20 m	13 mm	6	LTB-20
30 m	13 mm	6	LTB-30

Long Measuring Tapes with Steel Blade and Open Case



LT-STEEL

L	Blade Width	Quantity	Model
30 m	13 mm	5	LT-STEEL-30
50 m	13 mm	5	LT-STEEL-50

MEASURING WHEELS

Metric Rubber Coated Measuring Wheels 150 mm



MW-150

L	Quantity	Model
150 mm	2	MW-150

Metric Rubber Coated Measuring Wheels 250 mm



MW-250

L	Quantity	Model
250 mm	2	MW-250

SPIRIT LEVELS

Thick Shaped Aluminium Profile Spirit Levels



466

L	Quantity	Model
400 mm	4	466-400
400 mm	4	466-400-M
600 mm	4	466-600
600 mm	4	466-600-M
800 mm	4	466-800
800 mm	4	466-800-M
1000 mm	4	466-1000
1000 mm	4	466-1000-M
1200 mm	4	466-1200
1200 mm	4	466-1200-M
1800 mm	4	466-1800
2000 mm	4	466-2000

Rectangular Aluminium Profile Spirit Levels



426

L	Blade Width	Quantity	Model
400 mm	49x22 mm	1	426-400
600 mm	49x22 mm	1	426-600
800 mm	49x22 mm	1	426-800
1000 mm	49x22 mm	1	426-1000
1200 mm	49x22 mm	1	426-1200

400 mm and 600 mm with 2 vials. 600 mm to 1200 mm with 3 vials



Light Aluminium Spirit Levels



416

Length	Quantity	Product Code
400 mm	10	416-400
600 mm	10	416-600
800 mm	10	416-800
1000 mm	10	416-1000
1200 mm	10	416-1200
1500 mm	10	416-1500
1800 mm	10	416-1800
2000 mm	10	416-2000

Level made from solid injected aluminium



405

Length	Quantity	Product Code
400 mm	5	405-400
600 mm	5	405-600
800 mm	10	405-800
1000 mm	5	405-1000

Magnetic Level, Solid Injected Aluminium



405_M

Length	Quantity	Product Code
400 mm	5	405-400-M
600 mm	5	405-600-M
800 mm	5	405-800-M
1000 mm	5	405-1000-M

Lightweight Level made from solid injected aluminium



405L

Length	Quantity	Product Code
400 mm	10	405L-400
600 mm	10	405L-600

Lightweight Magnetic Level made from solid injected aluminium



405L_M

Length	Quantity	Product Code
400 mm	5	405L-400-M
600 mm	5	405L-600-M

Solid Injected Aluminium Spirit Levels



406

Length	Quantity	Product Code
300 mm	1	406-300
400 mm	5	406-400
500 mm	5	406-500
600 mm	5	406-600
800 mm	5	406-800

Solid Injected Aluminium Magnetic Spirit Levels



406_M

Length	Quantity	Product Code
300 mm	1	406-300-M
400 mm	1	406-400-M
500 mm	1	406-500-M
600 mm	1	406-600-M

Polystyrene Spirit Levels



406P

Length	Quantity	Product Code
400 mm	10	406P-400
600 mm	10	406P-600

Spirit Level Set 600/1200/1800 mm - 3 Pcs/Carry Bag



416-SET+BAG

Quantity	Product Code
3	416-SET+BAG

416-SET-1

4750-LV-1

BAHCO



Spirit Level Set 600/1200/1800 mm - 3 Pcs



416-SET-1



3 5 416-SET-1

416-600, 416-1200, 416-1800



Spirit Level Set 600/1200/2000 mm - 3 Pcs



416-SET-2



3 5 416-SET-2

416-600, 416-1200, 416-2000



Magnetic Plastic Spirit Torpedo Levels



406T-225



228 mm 10 406T-225

DISP is a counter display with 12 units

Aluminium Spirit Torpedo Levels



426TOR9



230 mm 10 426TOR9

Aluminium Spirit Scaffold Levels



466-250



250 mm 10 466-250

Aluminium Spirit Line Levels 75 mm



466-LINE



75 mm 12 466-LINE

Flat Surface 2-Way Spirit Levels



466-BE1



20 g 12 466-BE1

Magnetic Spirit Levels for Fence Post



466-POST



120 x 75 x 80 mm 6 466-POST

Aluminium Straight Edge Spirit Levels



486



1800 mm 5 486-1800
2000 mm 5 486-2000
2400 mm 5 486-2400

Aluminium Straight Edge Spirit Levels Unhandled



486-xxxWH



1800 mm 5 486-1800WH
2000 mm 5 486-2000WH
2400 mm 5 486-2400WH

Double T-Profile Spirit Precision Levels



496

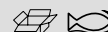

1500 mm 5 496-1500
1800 mm 5 496-1800



Spare Vial for 496 Levels



496-SPARE

496-1500, 496-1800	1	496-SPARE

MARKING

Chalk Lines 5x Rewind



CL-1441

185 mm	36	CL-1441

Chalk Lines 1x Rewind



CL-1331

185 mm	48	CL-1331

Chalk Lines 3x Rewind



CL-1221

130 mm	6	CL-1221

Marking Chalk 227 g/Pour Bottle



CHALK

227 g	6	CHALK-BLUE
227 g	6	CHALK-WHITE
227 g	6	CHALK-RED
227 g	6	CHALK-YELLOW

Chalk Line Set 3x Rewind - 3 Pcs



CL-1221-SET

180 g	4	CL-1221-SET

CHALK-BLUE

466-LINE

CL-1221

Plumb Bobs with 5 m Cord



PBS

5 m	6	PBS-700

Plumb Bobs with Hardened Steel Tip



PBB

185 mm	227 g	8	PBB-8

HB Grade Pencils - 25 Pcs/Box



P-HB

175 mm	25	25	P-HB

FSC Certificate Code: QMI-COC-001417 File No.: 1627439

HB Grade Pencils - 200 Pcs/Display



PENCIL-200

180 mm	200	1 PENCIL-200-DISP

HB Grade Pencils



P-MEC

150 mm	1	24 P-MEC
100 mm	5	12 P-MEC-LEAD

Scribers with Interchangeable Carbide Point



1179-SCRIBE

150 mm	5	1179-SCRIBE
	1	1179-TIPS

Tungsten Carbide Scribers



1178-SCRIBE

150 mm	5	1178-SCRIBE

High Performance Alloy Steel Offset Scribers



1177-SCRIBE

230 mm	5	1177-SCRIBE

RULES

5-Section Wooden Folding Rules 1 m



WR1

1 m	17 mm	50 WR1
1 m	17 mm	50 WR1-MM

10-Section Wooden Folding Rules 2 m



WR2

2 m	17 mm	25 WR2
2 m	17 mm	25 WR2-MM

Wooden Folding Rules with 12 Section 2 m



WR2-12

2 m	17 mm	25 WR2-12

Metric and Imperial Flexible Stainless Steel Rulers



1179-FLX

160 mm	12 mm	25 1179-FLX

Metric Stainless Steel Rulers



SR MM

150 mm	19 mm	12 SR150-MM
200 mm	19 mm	12 SR200-MM
300 mm	25 mm	12 SR300-MM
600 mm	30 mm	20 SR600-MM
1000 mm	35 mm	20 SR1000-MM



Imperial Stainless Steel Rulers



SR IN

Length	Blade Width	Quantity	Model
6 in	6 in	12	SR150-E
8 in	8 in	12	SR200-E
12 in	12 in	12	SR300-E
24 in	24 in	20	SR600-E
39 in	40 in	20	SR1000-E

Construction Squares for Layout and Setting Up

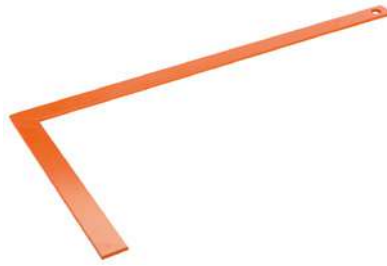

3085

Length	Blade Width	Quantity	Model
400 mm	200 mm	1	308504000
500 mm	250 mm	1	308505000
600 mm	300 mm	1	308506000
800 mm	400 mm	1	308508000
1000 mm	500 mm	1	308510000

Sliding Bevel Squares with Cold-Rolled Steel Blade



9572

Length	Blade Width	Quantity	Model
235 mm	115 mm	20	9572-200
250 mm	150 mm	20	9572-250

SQUARES

Carpenter Squares with Steel Blade



9045-B

Length	Blade Width	Quantity	Model
220 mm	170 mm	6	9045-B-200
250 mm	170 mm	6	9045-B-250
300 mm	170 mm	6	9045-B-300
400 mm	170 mm	1	9045-B-400

Sliding Combination Squares with Metal Scriber



CS

Length	Blade Width	Quantity	Model
152 mm	90 mm	12	CS150
305 mm	125 mm	12	CS300
407 mm	125 mm	12	CS400

Spare parts, 4 pcs set.

Spare parts Kit for CS Model Sliding Squares - 4 Pcs



CS-SPARE

Quantity	Model
1	CS-SPARE

Bevel Squares with Steel Blade



9574

Length	Blade Width	Quantity	Model
215 mm	165 mm	10	9574-200
285 mm	170 mm	10	9574-250
300 mm	170 mm	10	9574-300

Carpenter Squares with Stainless Steel Blade and Sliding Marker



9048

Length	Blade Width	Quantity	Model
200 mm	165 mm	10	9048-200
250 mm	165 mm	10	9048-250
300 mm	180 mm	10	9048-300
350 mm	180 mm	10	9048-350
400 mm	180 mm	10	9048-400

Fixed Bevel Squares with Stainless Steel Blade



9575

Length	Blade Width	Quantity	Model
250 mm	110 mm	6	9575-250

Flat Carpenter Squares with Steel Blade



FCS-600/FCS-1000

600 mm	300 mm	6	FCS-600
800 mm	300 mm	6	FCS-800
1000 mm	360 mm	6	FCS-1000

Mechanical Callipers



1150

150 mm	9 x 75 x 235 mm	1	1150-1/2H/P

Professional Feeler Gauges with 20 Blades



1547

20	100 mm	20	1547

0,05 mm steps Carbon steel

Adjustable Precision Squares



AS-1200

1265 mm	560 mm	3	AS-1200

Professional Feeler Gauges with 26 Blades

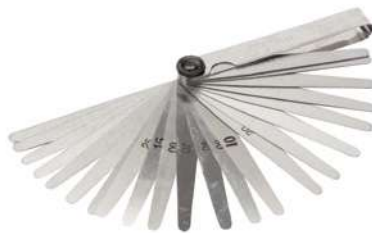

1544

26	100 mm	1	1544

0,03 mm to 0,1 mm in 0,01 mm increments / 0,10 mm to 1,0 mm in 0,05 mm increments

Screw Pitch Gauges with Metric 60°



1535

24	67 mm	1	1535

Stainless steel

PRECISION MEASURING

Precision Measuring Digital Callipers with LCD Screen



1150D

150 mm	25 x 90 x 245 mm	1	1150D

Professional Feeler Gauges with 13 Blades



1546

100 mm		1	1546

(0,05-0,30) x 0,05mm (0,30-1,00) x 0,10 mm Carbon steel

Screw Pitch Gauges with Metric 60° and Whitworth 55°



1537

0.25-6.0 / 4-62	70 mm	1	1537

0,25-6,00 mm, 4 to 62 TPI Stainless steel





BAHCO



Wall Tools



SCRAPERS

ERGO™ Precision Paint Scrapers with Dual-Component Handle



ergo



625



25 mm



5 625

Replacement Blades for 625 ERGO™ Scrapers



449



25 mm



10 449

Replacement Blades for 625 ERGO™ Scrapers



625-



3 g

3 g

3 g



10 625-DROP

10 625-PEAR

10 625-ROUND

ERGO™ Universal Paint Scrapers with Dual-Component Handle



ergo



650



50 mm



5 650

Replacement Blades for 650 ERGO™ Scrapers



442



50 mm

50 mm



10 442-3P

10 442

442-3P: set of 3 blades of 442

Replacement Blades for 650 and 665 ERGO™ Scrapers



850 / 865



50 mm

65 mm



10 850-1

10 865-1

ERGO™ Heavy Duty Paint Scrapers with Dual-Component Handle



ergo



665



65 mm



5 665

Replacement Blades for 665 ERGO™ Scrapers



451



65 mm



10 451

ERGO™ Paint Scrapers Set with Dual-Component Handle



ergo



SCRAPER-SET2



50 x 145 x 265 mm



1 SCRAPER-SET2

625

625-DROP, 625-PEAR, 625-ROUND

650



Cabinet Scrapers with Plastic Edge Protector



474

Blade Width	Blade Length	Blade Thickness	Quantity	Product Code
130 mm	10	474-125-0.60	10	474-125-0.60
130 mm	10	474-125-0.80	10	474-125-0.80
150 mm	10	474-150-0.60	10	474-150-0.60
150 mm	10	474-150-0.80	10	474-150-0.80

Paint Scrapers with Carbon Steel Blade and Wooden Handle



2155

Blade Width	Blade Length	Blade Thickness	Quantity	Product Code
30 mm	195 mm	12	215500300	
40 mm	195 mm	12	215500400	
50 mm	195 mm	12	215500500	
60 mm	215 mm	12	215500600	
70 mm	220 mm	12	215500700	
80 mm	225 mm	12	215500800	
90 mm	230 mm	12	215500900	
100 mm	234 mm	12	215501000	

Paint Scrapers with Carbon Steel Blade and Plastic Handle



216

Blade Width	Blade Length	Blade Thickness	Quantity	Product Code
30 mm	210 mm	12	216000300	
40 mm	210 mm	12	216000400	
50 mm	210 mm	12	216000500	
60 mm	210 mm	12	216000600	
70 mm	210 mm	12	216000700	
80 mm	210 mm	12	216000800	
90 mm	228 mm	12	216000900	
100 mm	230 mm	12	216001000	
120 mm	230 mm	12	216001200	

Paint Scrapers with Carbon Steel Blade and Dual-Component Handle



2150

Blade Width	Blade Length	Blade Thickness	Quantity	Product Code
30 mm	225 mm	12	215000030	
40 mm	225 mm	12	215000040	
50 mm	225 mm	12	215000050	
60 mm	225 mm	12	215000060	
70 mm	225 mm	12	215000070	
80 mm	225 mm	12	215000080	
90 mm	220 mm	12	215000090	
100 mm	220 mm	12	215000100	
120 mm	220 mm	12	215000120	

Paint Scrapers with Stainless Steel Blade and Dual-Component Handle



2161

Blade Width	Blade Length	Blade Thickness	Quantity	Product Code
40 mm	215 mm	12	216100040	
60 mm	215 mm	12	216100060	
80 mm	215 mm	12	216100080	
100 mm	235 mm	12	216100100	
120 mm	235 mm	12	216100120	

Paint Scrapers with Rigid Blade and Plastic Handle



2165

Blade Width	Blade Length	Blade Thickness	Quantity	Product Code
30 mm	180 mm	12	216500300	
50 mm	180 mm	12	216500500	
75 mm	200 mm	12	216500750	
100 mm	200 mm	12	216501000	

Filling Scrapers with Carbon Steel Blade and Wooden Handle



2190

Blade Width	Blade Length	Blade Thickness	Quantity	Product Code
100 mm	235 mm	5	219001000	
120 mm	230 mm	5	219001200	
140 mm	245 mm	5	219001400	
160 mm	235 mm	5	219001600	
200 mm	245 mm	5	219002000	

Filling Scrapers with Stainless Steel Blade and Wooden Handle



2192

Blade Width	Blade Length	Blade Thickness	Quantity	Product Code
100 mm	235 mm	5	219201000	
120 mm	230 mm	5	219201200	
140 mm	235 mm	5	219201400	
160 mm	245 mm	5	219201600	
200 mm	235 mm	5	219202000	

Filling Scrapers with Reinforced Stainless Steel Blade and Wooden Handle



2193

Blade Width	Blade Length	Blade Thickness	Quantity	Product Code
250 mm		10	219302500	
300 mm		10	219303000	
350 mm		10	219303500	



Glue Comb Scrapers with Triangular Teeth



2212

Blade Width	Blade Length	Quantity	Product Code
130 mm	120 mm	5	221201200
130 mm	200 mm	5	221202000
130 mm	300 mm	5	221203000

Putty Knives with Stainless Steel Blade and Dual-Component Handle



2489

Quantity	Product Code
12	2489

Masonry Trowels with Sharp Tipped Blade and Wooden Handle



2308

Blade Width	Blade Length	Quantity	Product Code
120 mm	70 mm	6	2308A0000
150 mm	100 mm	6	2308B0000

Glue Comb Scrapers with Square Teeth



2213

Blade Width	Blade Length	Quantity	Product Code
130 mm	120 mm	5	221301200
130 mm	200 mm	5	221302000
130 mm	300 mm	5	221303000

Madrid Model Masonry Trowels with Wooden Handle



2303

Blade Width	Blade Length	Quantity	Product Code
70 mm	110 mm	6	2303B0000
80 mm	135 mm	6	2303D0000

Plastering Trowels with Carbon Steel Blade and Wooden Handle



204

Blade Width	Blade Length	Quantity	Product Code
300 mm	150 mm	12	204030150
300 mm	160 mm	12	204030160
300 mm	180 mm	12	204030180
500 mm	130 mm	6	204050130

Hook Knives with Stainless Steel Blade and Dual-Component Handle



2488

Quantity	Product Code
12	2488

Sevilla Model Masonry Trowels with Wooden Handle



2304

Blade Width	Blade Length	Quantity	Product Code
115 mm	200 mm	6	2304C0000

Plastering Trowels with Triangle Serrated Teeth Carbon Steel Blade and Wooden Handle



209

Blade Width	Blade Length	Quantity	Product Code
270 mm	115 mm	12	209027040

Plastering Trowels with Square Serrated Teeth Carbon Steel Blade and Wooden Handle



2092



275 mm	115 mm	12	209227060
280 mm	130 mm	12	209228100
500 mm	130 mm	6	209250100

Plastering Trowels with Plastic Blade and Polystyrene Handle



211



350 mm	180 mm	5	211035180
420 mm	210 mm	5	211042210

Aluminium Plastering Scribes with Long Handle



2127



90 mm	435 mm	6	212704350
-------	--------	---	-----------

Plastering Trowels with Stainless Steel Blade and Long Poplar Wooden Handle



2045



300 mm	140 mm	12	204530140
500 mm	130 mm	6	204550130

Plastering Trowels with Notched Base and Polystyrene Handle



2120

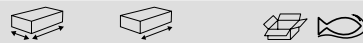

270 mm	180 mm	5	212027180
330 mm	220 mm	8	212033220

Flat and Serrated Plasterer's Rails with Wooden Handle



2145xxxD



45 x 20 x 275 mm	1	2145020D0
45 x 25 x 275 mm	1	2145025D0
45 x 30 x 275 mm	1	2145030D0
45 x 35 x 275 mm	1	2145035D0

Plastering Trowels with Stainless Steel Blade and Light Poplar Wooden Handle



2045A

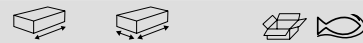

140 mm	300 mm	12	2045A3000
--------	--------	----	-----------

Notched Base Plastering Trowels with Polystyrene Handle



213



265 mm	140 mm	5	213026140
--------	--------	---	-----------

Flat Plasterer's Rails with Wooden Handle



2145xxxL



45 x 20 x 275 mm	1	2145020L0
45 x 25 x 275 mm	1	2145025L0
45 x 30 x 275 mm	1	2145030L0
45 x 35 x 275 mm	1	2145035L0



Curved Plasterer's Rails with Wooden Handle



2145xxxC

45 x 25 x 225 mm	1	2145025C0	
45 x 35 x 210 mm	1	2145039C0	

Hard Rubber Grout Float Plastering Trowels with Anti-Shock Polystyrene Handle



2125

220 mm	135 mm	10	212502150



Board Filter Cable



250400020

180 g	1 250400020

Joints Plastering Trowels with Anti-Shock Polystyrene Handle



2122

250 mm	100 mm	10	212202500



Soft Rubber Grout Float Plastering Trowels with Anti-Shock Polystyrene Handle



2126

140 mm	220 mm	10	212602150
140 mm	280 mm	1	212602800



Board Filter Parts Set



250400030

80 g	1 250400030

Sponge Base Plastering Trowels with Anti-Shock Polystyrene Handle and Hanging Clip



2123

140 mm	280 mm	10	212302900



DRYWALL TOOLS

Lift Spare Set with 2 Springs and Brakes



250400010

80 g	1 250400010

Setting Tools for Metal Anchors



250501800

185 mm	50 250501800



Setting Tools for Metal Anchors with Sprung Handle



250502450



245 mm



1 250502450



Spare Mitres for 864 Trim Cutter



864000020



20 g



1 864000020

Punching Tools for Dry Lining Walls



671002600



260 mm



50 671002600



Trim Cutters with Variable Angle



8640



230 mm



50 864002450



Adjustable Trim Cutters



8641



245 mm



1 864102400



Punching Tools with Articulated Head for Dry Lining Walls



671002850



295 mm



1 671002850



Spare Blades for 8640 Trim Cutter



864000010



20 g



1 864000010

Spare Blades for 8641 Trim Cutter



864100010



5 g



1 864100010





BAHCO



Hand Hacksaws



HAND HACKSAW FRAMES

ERGO™ Professional Hand Hacksaw Frames 300 mm



ergo



325

300 mm	5	325

Professional Hand Hacksaw Frames with Aluminium Handle 300 mm



225-PLUS

300 mm	5	225-PLUS

Professional Hand Hacksaw Frames with Soft Grip Handle 300 mm



319

300 mm	5	319

Hand Hacksaw Frames 432 mm



317

432 mm	10	317

Compact Hand Hacksaw Frames 470 mm



306

440 mm	10	306

Traditional Hand Hacksaw Frames 504 mm



320

504 mm	10	320

Traditional Hand Hacksaw Frames 517 mm



304

517 mm	10	304

Mini Hacksaws with Sandflex® Bi-Metal Blade



208

330 mm	5	208

Compass Saws 8 Blade Positions



321

330 g	5	321

Compass Saws 4 Blade Positions



210

360 g	10	210

Junior Hacksaws with Steel Frame and Fibreglass Handle 150 mm



268

150 mm	5	268

Junior Hacksaws with Steel Wire Frame and Handle 290 mm



239

260 mm	150	239

Junior High-Arch Hacksaws with Steel Profile Frame and Wooden Handle 150 mm



238

150 mm	60	238

Junior Hacksaws with Steel Profile Frame and Wooden Handle 150 mm



228

150 mm	80	228
150 mm	5	228-BULK

Junior Hacksaws with Steel Wire Frame and Wooden Handle 291 mm



219

291 mm	120	219

Junior Hacksaws with Steel Wire Frame and Handle 235 mm



218

235 mm	10	218
235 mm	150	218-BULK

HAND HACKSAW BLADES

Sandflex® Bi-Metal Spiro Hand Hacksaw Blades



3806-SPIRO

600 mm	32	10 3806-600-32

Sandflex® Bi-Metal Hand Hacksaw Blades



3906

250 mm	18	100 3906-250-18-100
250 mm	24	100 3906-250-24-100
250 mm	32	100 3906-250-32-100
300 mm	14	100 3906-300-14-100
300 mm	18	100 3906-300-18-100
300 mm	24	100 3906-300-24-100
300 mm	32	100 3906-300-32-100
300 mm	18-28	100 3818-300-PROG-100
300 mm	14	10 3906-300-14-10P
300 mm	18	10 3906-300-18-10P
300 mm	24	10 3906-300-24-10P
300 mm	32	10 3906-300-32-10P
250 mm	18	10 3906-250-18-5P
250 mm	24	10 3906-250-24-5P
250 mm	32	10 3906-250-32-5P
300 mm	14	10 3906-300-14-5P
300 mm	18	10 3906-300-18-5P
300 mm	24	10 3906-300-24-5P
300 mm	32	10 3906-300-32-5P
300 mm	18-28	10 3818-300-PROG-5P
300 mm	18/24/32	10 3906-300-3P
300 mm	18	10 3906-300-18-2P
300 mm	24	10 3906-300-24-2P
300 mm	32	10 3906-300-32-2P



Sandcut® High Speed Steel Hand Hacksaw Blades



3905

L	Teeth	Quantity	Part Number
250 mm	24	100	3905-250-24-100
300 mm	14	100	3905-300-14-100
300 mm	18	100	3905-300-18-100
300 mm	24	100	3905-300-24-100
300 mm	32	100	3905-300-32-100
300 mm	24	10	3905-300-24-2P

Junior Hacksaw Spare Blades



228-P

L	Teeth	Quantity	Part Number
150 mm	15	10	228-15-5P
150 mm	32	10	228-32-5P
150 mm	32	10	228-32-10P
150 mm	32	1	228-32-100P

Tungsten Carbide Grit Hand Hacksaw Blade



3816

L	Teeth	Quantity	Part Number
300 mm	12	50	3816-300

Junior Hacksaw Rod Blades 150-300 mm



216-R

L	Teeth	Quantity	Part Number
150 mm	20	1	216-150-R
300 mm	20	1	216-300-R

Junior Hacksaw Rod Blades 150 mm



215

L	Teeth	Quantity	Part Number
150 mm	110	1	215-150

Sandflex® Interchangeable Compass Hand Hacksaw Blades



321-SB

L	Teeth	Quantity	Part Number
310 mm	7	10	321-7-SB
310 mm	18	10	321-18-SB
310 mm	24	10	321-24-SB



Handsaws



HANDSAWS FOR CONSTRUCTION MATERIAL

ProfCut™ Toolbox General Purpose Handsaws



PC-GNP

375 mm	15/16	4	PC-15-GNP



PrizeCut™ Compass Saws for Wood/Plastic



NP-COM

300 mm	7/8	4	NP-12-COM



ProfCut™ Handsaws for Plaster/Boards of Wood Based Materials



PC-PLS

600 mm	7/8	4	PC-24-PLS



Superior™ General Purpose Sawblades, Used with ERGO™ EX Handles



EX-16-GNP-C

400 mm	15/16	10	EX-16-GNP-C



ProfCut™ Compass Saws for Wood/Plastic



PC-COM

300 mm	9/10	4	PC-12-COM



Superior™ Sawblades for Plaster and Boards, Used with ERGO™ EX Handles



EX-22-PLS-C

550 mm	7/8	10	EX-22-PLS-C



Superior™ Compass Saws for Wood/Plastic



3150

300 mm	9/10	4	3150-12-XT9-HP



Compass Saws for Plaster/Drywall/Boards of Wood Based Materials



PC-6-DRY

160 mm	8	6	PC-6-DRY



ProfCut™ Handsaws for Hard Plastic Tubes/Profiles



PC-22-PLC

550 mm	11/12	4	PC-22-PLC



ProfCut™ Handsaws for Polystyrene/
Stucco Profiles/Foams



PC-DECO

400 mm	18/19	4	PC-16-DECO



ProfCut™ Handsaws for Lightweight
Concrete/Leca®/Bricks



256

650 mm	2	4	256-26



General Purpose Handsaws for Plastics/
Laminates/Wood/Soft Metals



300

350 mm	15/16	4	300-14-F15/16-HP



ProfCut™ Handsaws for Lightweight
Concrete/Leca®/Bricks 1.3 TPI



255-34

620 mm	1,3	2	255-34



Insulation Saws for Mineral Wool/Stone
Wool/Eco Wool/Styrex®



PC-22-INS

550 mm	WT	4	PC-22-INS



General Purpose Spare Sawblades



369

360 mm	13/14	20	369-BLADE



ProfCut™ Handsaws for Lightweight
Concrete/Leca®/Bricks 0.6 TPI



255-17/34

620 mm	0.6	2	255-17/34



Folding Saw Specifically for Cutting
Insulation Wool Material



396-INS

190 mm	WT	10	396-INS



PrizeCut™ Universal Handsaws for
Plastics/Laminates/Wood/Soft Metals



NP

400 mm	7/8	4	NP-16-U7/8-HP
475 mm	7/8	10	NP-19-U7/8-HP
550 mm	7/8	10	NP-22-U7/8-HP



HANDSAWS FOR WOOD



PrizeCut™ Sawblades for Fine to Medium Thick Materials, Used with ERGO™ EX Handles



EX-NPP-22

550 mm	7/8	10	EX-NPP-22



PrizeCut™ Sawblades for All Types of Wood, Used with ERGO™ EX Handles



EX-22-U7

550 mm	7/8	10	EX-22-U7



ERGO™ Superior™ Toolbox Saws for Plaster/Boards of Wood Based Materials



ergo



2600-16

400 mm	11/12	4	2600-16-XT11-HP



Superior™ Sawblades for Medium to Thick Material, Used with ERGO™ EX Handles



EX-XT9

475 mm	9/10	10	EX-19-XT9-C
550 mm	9/10	10	EX-22-XT9-C



ProfCut™ Hardpoint Handsaws for Plaster/Boards of Wood Based Materials



PC-GT7

475 mm	7/8	4	PC-19-GT7
550 mm	7/8	4	PC-22-GT7



ERGO™ Superior Tenon Saws for Plastics/Laminates/Wood/Soft Metals



ergo



3180

350 mm	11/12	4	3180-14-XT11-HP



PrizeCut™ Crosscut Handsaws for Coarse/Medium Thick Wood Materials



NP-FLEEM

550 mm	7	10	NP-22-F7/8-HP



Fileable Universal Handsaws for Plastics/Laminates/Wood/Soft Metals



PC-FILE

400 mm	7/8	4	PC-16-FILE-U7
475 mm	7/8	4	PC-19-FILE-U7
550 mm	7/8	4	PC-22-FILE-U7
600 mm	7/8	4	PC-24-FILE-U7



ERGO™ Superior™ Veneer Handsaws for Plywood and Plastic



ergo



3240

350 mm	11/12	4	3240-14-XT11-HP



ERGO™ Superior™ Saws for Plaster/
Boards of Wood Based Materials



2600

475 mm	9/10	4	2600-19-XT-HP
550 mm	9/10	4	2600-22-XT-HP



Handsaws for Plastics/Laminates/Wood/
Soft Metals



244

500 mm	7/8	10	244-20-U7/8-HP
550 mm	7/8	10	244-22-U7/8-HP



Superior™ Sawblades for Fine to Medium
Thick Materials, Used with ERGO™ EX
Handles



EX-20-XT11-C

500 mm	11/12	10	EX-20-XT11-C



Hardpoint Handsaws for Plastics/
Laminates/Wood/Soft Metals



2500 XT

400 mm	11/12	4	2500-16-XT-HP
475 mm	9/10	4	2500-19-XT-HP
550 mm	9/10	4	2500-22-XT-HP
600 mm	7/8	4	2500-24-XT7-HP



Superior™ Sawblades for Laminates and
Wooden Floors, Used with ERGO™ EX
Handles



EX-20-LAM-C

500 mm	11/12	10	EX-20-LAM-C



Superior™ Tenon Sawblades for Plastics,
Laminates, Wood and Soft Metals, Used
with ERGO™ EX Handles



EX-14-TEN-C

350 mm	11/12	5	EX-14-TEN-C



ProfCut™ Laminator Saws for Laminate/
Wooden Floors



PC-LAM

500 mm	11/12	4	PC-20-LAM



ERGO™ Superior™ Saws for Plastics/
Laminates/Wood/Soft Metals



3090

500 mm	11/12	4	3090-20-XT11-HP



ERGO™ Superior™ Laminator Saws for
Laminate/Wooden Floors



SUP-LAM

500 mm	11/12	4	SUP-20-LAM



Superior™ Veneer Sawblades for
Plywood/Plastic, Used with ERGO™ EX
Handles



EX-14-VEN-C

350 mm	11/12	10	EX-14-VEN-C



ProfCut™ Hardpoint Handsaws for Hard Wood/Plywood/Thin Profile



PC-GT9

475 mm	9/10	4	PC-19-GT9
550 mm	9/10	4	PC-22-GT9

PrizeCut™ Hardpoint Sawblades for Fine/Medium Thick Material



PC-VEN

300 mm	11/12	4	PC-12-VEN

PrizeCut™ Veneer Saws for Fine/Medium Thick Material



NP-VEN

300 mm	13/14	10	NP-12-VEN

ProfCut™ Toolbox Handsaws for Fine to Medium Thick Materials



PC-TBX

375 mm	11/12	4	PC-15-TBX

ProfCut™ Sawblades for Fine/Medium Thick Material



PC-PRC

500 mm	9/10	4	PC-20-PRC

Superior™ Sawblades for Coarse/Thick Material, Used with ERGO™ EX Handles



EX-XT7

550 mm	7/8	10	EX-22-XT7-C
600 mm	7/8	10	EX-24-XT7-C

ProfCut™ Tenon Handsaws for Medium Thick Materials



PC-TEN

300 mm	11/12	4	PC-12-TEN

PrizeCut™ Tenon Saws for Fine/Medium Thick Material



NP-TEN

300 mm	13/14	10	NP-12-TEN

Barracuda Sawblades for Medium to Thick Materials, Used with ERGO™ EX Handles



EX-244P-22

550 mm	7/8	10	EX-244P-22

Handsaws with Dual-Component for Medium to Thick Wood



244P

500 mm	7/8	4	244P-20-U7-HP
550 mm	7/8	10	244P-22-U7-HP



Wooden Mitre Boxes with Optional Side Wall



233

65 x 135 x 300 mm	5 233-300
75 x 135 x 300 mm	5 233-300-A
65 x 135 x 400 mm	5 233-400



PRECISION HANDSAWS

ProfCut™ General Carpentry Pull-Saws for Wood and Plastic



PC-12-PS

305 mm	13.5	4	PC-12-14-PS
305 mm	13.5	10	PC-12-14-PS-B



ERGO™ Superior Handsaws for Timber/Wet/Tanalised Wood



2700

550 mm	7/8	4	2700-22-XT7-HP
600 mm	7/8	4	2700-24-XT7-HP



Laminated Wood Mitre Boxes



234-W

53 x 77 x 245 mm	10 234-W1
63 x 95 x 300 mm	10 234-W2
80 x 100 x 300 mm	10 234-W3



ProfCut™ Tenon Pull-Saws for Wood and Plastic



PC-11-PS

270 mm	18.5	4	PC-11-19-PS
270 mm	18.5	10	PC-11-19-PS-B



ProfCut™ Timber Saws for Timber/Wet/Tanalised Wood



PC-TIM

600 mm	3.5/4.5	4	PC-24-TIM



Aluminium Mitre Boxes



234-A

55 x 65 x 245 mm	1 234-A1
40 x 106 x 245 mm	1 234-A2



ProfCut™ Double Edge Pull-Saws for Wood and Plastic



PC-9-PS

240 mm	6-8.5 / 17	4	PC-9-9/17-PS
240 mm	6-8.5 / 17	10	PC-9-9/17-PS-B



ProfCut™ Dovetail Saws with Angled Swinging Wooden Handle



PC-DTF

250 mm	15/16	10 PC-10-DTF



ProfCut™ Dovetail Saws with Straight Wooden Handle



PC-DTR

250 mm	15/16	10 PC-10-DTR



ProfCut™ Dovetail Saws with Angled Wooden Handle



PC-DTL

250 mm	15/16	10 PC-10-DTL



HANDLES & SHARPENERS

ERGO™ BHS Handle for EX Sawblade Large



EX-

120 x 330 x 60 mm	4 EX-LL	
120 x 330 x 60 mm	4 EX-RM	
120 x 330 x 60 mm	4 EX-RL	



Fret Saws with Frame and Wooden Handle



502

130 mm	25 502



Professional High Speed Steel Sharpeners



SHARP-INS

206 mm	100 SHARP-INS



Fret Saw Sets, 2 pieces



502-SET2

2	130 g	35 502-SET2



FRET SAWS & SAWBLADES

Fret Saws with Wooden Handle



302

130 mm	30 302



Fret Saw Sets, 6 pieces



502-SET6

6	500 g	10 502-SET6

Assortment of Spare Blades for 302 and 502 Fret Saws



302-6X4P



130 mm



1 302-6X4P

Fret Saw Spare Blades for Wood and Plastic



302W



1	130 mm	1	302-51W-12P
3	130 mm	1	302-53W-12P
5	130 mm	1	302-55W-12P
7	130 mm	1	302-57W-12P
9	130 mm	1	302-59W-12P
11	130 mm	1	302-511W-12P

MUSICAL SAW

Musical Handsaws with Wooden Handle



296



750 mm



1 296

Fret Saw Spare Blades for Metal



302M



1	130 mm	1	302-71M-12P
3	130 mm	1	302-73M-12P
5	130 mm	1	302-75M-12P
7	130 mm	1	302-77M-12P

COPING SAWS & SAWBLADES

Coping Saws with Wooden Handle



301



165 mm



50 301

Fret Saw Spiral Spare Blades for Wood and Plastic



302S



1	130 mm	1	302-81S-12P
3	130 mm	1	302-83S-12P
5	130 mm	1	302-85S-12P

Coping Sawblades for 301 Saw

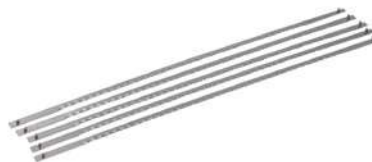

303



165 mm



10 303-5P



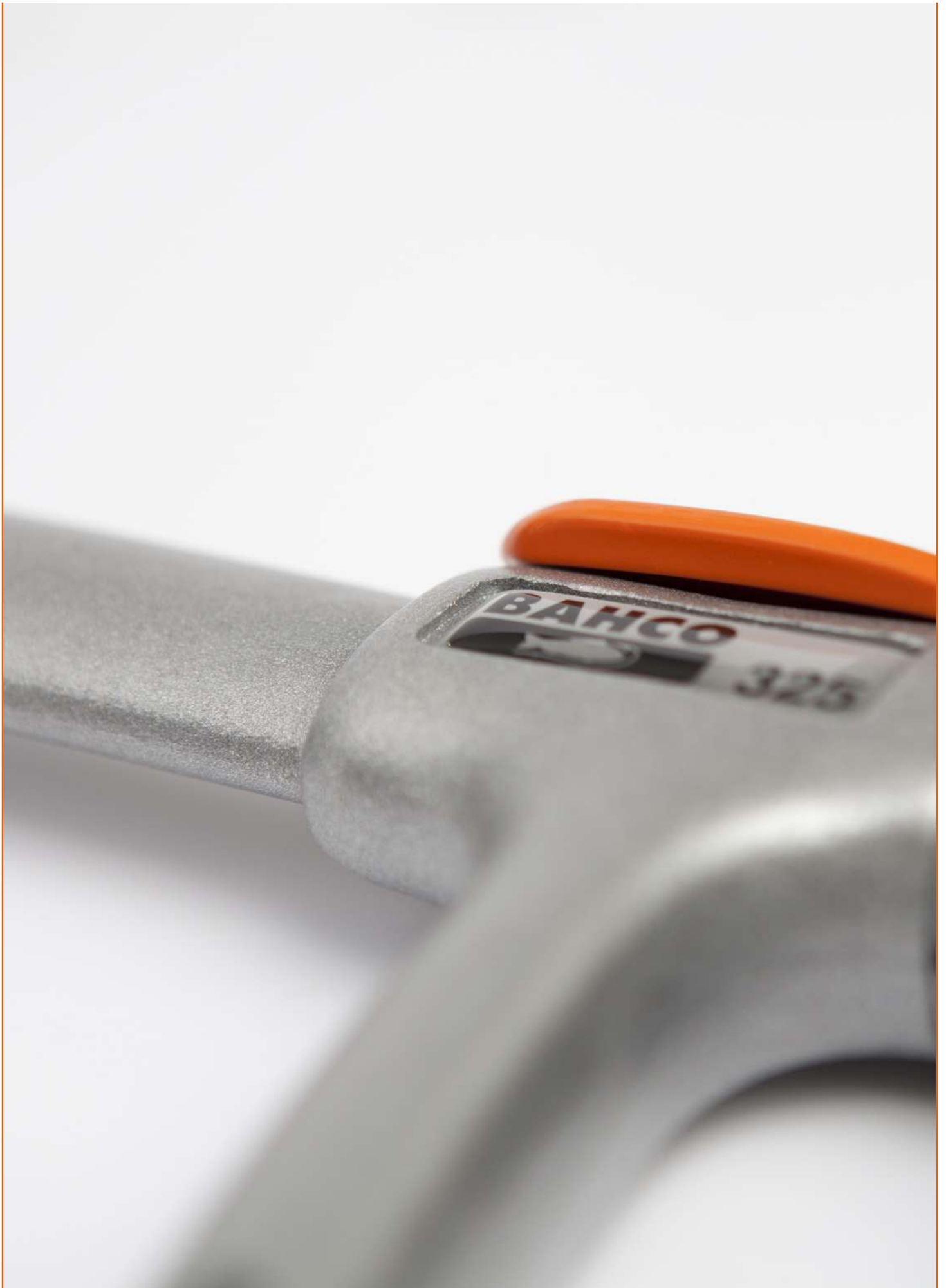

BAHCO



Wood Chisels



WOODWORKING CHISELS

ERGO™ Splitproof Woodworking Chisels



ergo



434

Icon	Icon	Icon
6 mm	4	434-6
8 mm	4	434-8
10 mm	4	434-10
12 mm	4	434-12
14 mm	4	434-14
15 mm	4	434-15
16 mm	4	434-16
18 mm	4	434-18
20 mm	4	434-20
22 mm	4	434-22
25 mm	4	434-25
28 mm	4	434-28
30 mm	4	434-30
32 mm	4	434-32
35 mm	4	434-35
38 mm	4	434-38
50 mm	4	434-50

Suitable for an intensive use with a metallic hammer

ERGO™ Splitproof Chisel Set - 3 Pcs/ Cardboard Box



ergo



434-S3-EUR

Icon	Icon	Icon
3	1	434-S3-EUR

Suitable for an intensive use with a metallic hammer

434-12, 434-18, 434-25

6 pcs ERGO™ Splitproof chisel set in leather roll pouch.



ergo



434-S6-LR

Icon	Icon	Icon
6	1	434-S6-LR

Suitable for an intensive use with a metallic hammer

434-6, 434-10, 434-12, 434-18, 434-25, 434-32

ERGO™ Splitproof Chisel Set - 6 Pcs/ Wooden Box



ergo



434-S6-EUR

Icon	Icon	Icon
6	1	434-S6-EUR

Suitable for an intensive use with a metallic hammer

434-6, 434-10, 434-12, 434-18, 434-25, 434-32

ERGO™ Splitproof Chisel Set - 8 Pcs/ Wooden Box



ergo



434-S8-EUR

Icon	Icon	Icon
8	1	434-S8-EUR

Suitable for an intensive use with a metallic hammer

434-6, 434-10, 434-12, 434-16, 434-18, 434-25, 434-32, 434-38

ERGO™ Splitproof Chisel Set - 6 Pcs/ Polyester Pouch



ergo



434-S6-PP

Icon	Icon	Icon
6	1	434-S6-PP

Suitable for an intensive use with a metallic hammer

434-6, 434-10, 434-12, 434-18, 434-25, 434-32

Woodworking Chisels with Rubberised Handle



424P

Icon	Icon	Icon
4 mm	4	424P-4
6 mm	4	424P-6
8 mm	4	424P-8
10 mm	4	424P-10
12 mm	4	424P-12
14 mm	4	424P-14
15 mm	4	424P-15
16 mm	4	424P-16
18 mm	4	424P-18
20 mm	4	424P-20
22 mm	4	424P-22
24 mm	4	424P-24
25 mm	4	424P-25
26 mm	4	424P-26
28 mm	4	424P-28
30 mm	4	424P-30
32 mm	4	424P-32
35 mm	4	424P-35
38 mm	4	424P-38
40 mm	4	424P-40

Chisel Set with Rubberised Handle - 3 Pcs/Cardboard Box



424P-S3-EUR

Icon	Icon	Icon
3	1	424P-S3-EUR

424P-12, 424P-18, 424P-25

Chisel Set with Rubberised Handle 6-32 mm - 6 Pcs/Leather Roll Pouch



424P-S6-LR

Icon	Icon	Icon
6	1	424P-S6-LR

424P-6, 424P-10, 424P-12, 424P-18, 424P-25, 424P-32

Chisel Set with Rubberised Handle - 6 Pcs/Wooden Box



424P-S6-EUR



6 1 424P-S6-EUR

424P-6, 424P-10, 424P-12, 424P-18, 424P-25, 424P-32



Chisel Set with Rubberised Handle - 6 Pcs/Wooden Box



424P-S6-GER



6 1 424P-S6-GER

424P-6, 424P-10, 424P-12, 424P-16, 424P-20, 424P-26



Chisel Set with Rubberised Handle - 8 Pcs/Wooden Box



424P-S8-EUR



8 1 424P-S8-EUR

424P-6, 424P-10, 424P-12, 424P-16, 424P-18, 424P-25, 424P-32, 424P-38



Chisel Set with Rubberised Handle - 6 Pcs/Polyester Pouch



424P-S6-PP



6 1 424P-S6-PP

424P-6, 424P-10, 424P-12, 424P-18, 424P-25, 424P-32



Woodworking Chisels with Orange Polypropylene Handle



414



6 mm	4	414-6
8 mm	4	414-8
10 mm	4	414-10
12 mm	4	414-12
14 mm	4	414-14
15 mm	4	414-15
16 mm	4	414-16
18 mm	4	414-18
20 mm	4	414-20
22 mm	4	414-22
25 mm	4	414-25
28 mm	4	414-28
30 mm	4	414-30
32 mm	4	414-32
35 mm	4	414-35
38 mm	4	414-38

10 mm	5 1031-10
12 mm	5 1031-12
14 mm	5 1031-14
16 mm	5 1031-16
18 mm	5 1031-18
20 mm	5 1031-20
22 mm	5 1031-22
25 mm	5 1031-25
28 mm	5 1031-28
30 mm	5 1031-30
32 mm	5 1031-32
40 mm	5 1031-40

Chisel Set with Polypropylene Handle - 3 Pcs/Cardboard Box



414-S3-EUR



3 1 414-S3-EUR

414-12, 414-18, 414-25



Chisel Set with Polypropylene Handle - 5 Pcs/Blister



9883



5 1 9883

1031-6, 1031-12, 1031-16, 1031-20, 1031-25



Woodworking Chisels with Red Polypropylene Handle



1031



4 mm	5	1031-4
6 mm	5	1031-6
8 mm	5	1031-8



Woodworking Chisels with Wooden Handle



425

Icon	Icon
4 mm	4 425-4
6 mm	4 425-6
8 mm	4 425-8
10 mm	4 425-10
12 mm	4 425-12
14 mm	4 425-14
15 mm	4 425-15
16 mm	4 425-16
18 mm	4 425-18
20 mm	4 425-20
22 mm	4 425-22
24 mm	4 425-24
25 mm	4 425-25
26 mm	4 425-26
28 mm	4 425-28
30 mm	4 425-30
32 mm	4 425-32
35 mm	4 425-35
38 mm	4 425-38
40 mm	4 425-40

Chisel Set with Wooden Handle - 5 Pcs/
Cardboard Box



425-082

Icon	Icon
5	1 425-082

425-6, 425-10, 425-12, 425-18, 425-25

Chisel Set with Wooden Handle - 6 Pcs/
Wooden Box



425-083

Icon	Icon
6	1 425-083

425-6, 425-10, 425-12, 425-18, 425-25, 425-32

3 pcs wooden-handle chisel set in
cardboard box



425-081

Icon	Icon
3	1 425-081

425-12, 425-18, 425-25

GOUGE CHISELS

Gouge Chisels with Rubberised Handle



422P

Icon	Icon
6 mm	4 422P-6
10 mm	4 422P-10
12 mm	4 422P-12
16 mm	4 422P-16
20 mm	4 422P-20
25 mm	4 422P-25

DEMOLITION CHISELS

Heavy Duty Wrecking Knives with
Rubberised Handle



2448

Icon	Icon	Icon
25 mm	231 mm	12 2448
25 mm	240 mm	12 SB-2448

Heavy Duty Wrecking Knives with Curved
Blade and Rubberised Handle



2449

Icon	Icon	Icon
25 mm	235 mm	12 2449
25 mm	235 mm	10 SB-2449

Spare Handles for 1031 Chisels



956

Icon	Icon	Icon
108 mm	50 g	1 956

WOOD CHISEL ACCESSORIES

Natural Grinding Stones



528-700



150 mm



1 528-700

Sharpening block



SBC110



30 x 65 x 110 mm



67 g



1 SBC110-65

Grinding Stones with Two Grains



528-COM



150 mm



1 528-COM

Block Plane Spare Blade



BP-40-95



112 mm



55 g



12 BP-40-95

Grinding Plain



BP-40



160 mm



1 BP-40

Protective Plastic Holsters



WC-HOL



292 mm



1 WC-HOL





BAHCO



Scissors & Knives



METAL SHEARS

Straight Cut Aviation Shears with Increased Power by Lever Action and Yellow Colour Coded Handle up to 1.5 mm



MA421



250 mm



10 MA421

Multipurpose Long Straight Cut Aviation/Compound Shears with Orange Handle



MA431



290 mm



1 MA431

8698M0250: Spare parts set

Right Cut Aviation Shears with Increased Power by Lever Action and Green Colour Coded Handle up to 1.5 mm



MA411



250 mm



10 MA411

8698M0250: Spare parts set

Right Cut Aviation Shears with Increased Power by Lever Action and Green Colour Coded Handle up to 1.8 mm



MA321



260 mm



10 MA321

8697M0260: Spare parts set

Left Cut Aviation Shears with Increased Power by Lever Action and Red Colour Coded Handle up to 1.5 mm



MA401



250 mm



10 MA401

8698M0250: Spare parts set

Left Cut Aviation Shears with Increased Power by Lever Action and Red Colour Coded Handle up to 1.8 mm



MA311



260 mm



1 MA311

8697M0260: Spare parts set

Straight Cut Aviation Shears with Increased Power by Lever Action



MA225



250 mm



4 MA225

Right Cut Aviation Shears with Increased Power by Lever Action



MA225R



250 mm



4 MA225R

Left Cut Aviation Shears with Increased Power by Lever Action



MA225L



250 mm



4 MA225L

Right Cut Pass-Through Shears with Increased Power by Lever Action and Green Colour Coded Handle



MA361

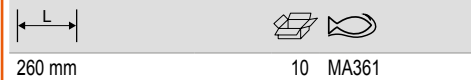

260 mm 10 MA361

8697M0260: Spare parts set

Long Straight Cut Pass-Through Metal Shears



MR340



340 mm 2 MR340

Right and Straight Cut Offset Pass-Through Metal Shears for Soft/Medium Materials



585D

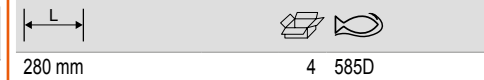

280 mm 4 585D

Left Cut Pass-Through Shears with Increased Power by Lever Action and Red Colour Coded Handle



MA351



250 mm 10 MA351

8697M0260: Spare parts set

Right and Straight Cut Offset Pass-Through Metal Shears for Medium/Hard Materials



583D



280 mm 4 583D

Left and Straight Cut Offset Pass-Through Metal Shears for Soft/Medium Materials



586D



280 mm 4 586D

Straight Cut Pass-Through Metal Shears with Increased Power by Lever Action



MA325



250 mm 4 MA325

Left and Straight Cut Offset Pass-Through Metal Shears for Medium/Hard Materials



584D



280 mm 4 584D

Left and Straight Cut Traditional/Industrial Metal Shears with Two Thin Blades



M227L



270 mm 4 M227L



Right and Straight Cut Traditional/Industrial Metal Shears with Two Thin Blades



M227R



270 mm



4 M227R

Right Cut Madrid Traditional/Industrial Metal Shears



8691



255 mm
300 mm



6 869102500
6 869103000

Right and Straight Cut Traditional/Industrial Metal Shears with Two Thin Blades and Return Spring



MR227R



270 mm



4 MR227R

Long Straight Cut Pass-Through Traditional/Industrial Shears



M330



11 3/4 mm



4 M330

Catalonian Traditional/Industrial Metal Shears



8692



300 mm



6 869203000

Straight Cut Pass-Through Two Hand Compound Shears



M6376



760 mm



1 M6376
1 M6376-SH

Straight Cut Traditional/Industrial Metal Shears with Two Thick Blades



M526



260 mm



4 M526

Left and Straight Cut Traditional/Industrial Metal Shears with Two Thin Blades and Return Spring



MR227L



270 mm



4 MR227L

Straight Cut Two Hand Compound Shears



M676



760 mm



1 M676
1 M676-SH

Metal Shears Nibblers with Eye Protecting Screen



M926

250 mm	1 M926 1 M926-SH

Heavy Duty Electrician Scissors with Groove



SCB140G

43 mm	140 mm	10 SCB140G

Electrician Scissors with Longer Handle



SC150NG

38 mm	155 mm	10 SC150NG

Multipurpose Heavy Duty Universal Snips



2744

190 mm	6 2744

Electrician Scissors with Optional Serrated Blade



SC127/SC127S

45 mm	130 mm	10 SC127
45 mm	127 mm	10 SC127S

Special Tin Snips with Curved Cutting Jaws



2704

110 mm	1 2704A

SCISSORS

Heavy Duty Electrician Scissors



SCB140

43 mm	140 mm	10 SCB140

Electrician Scissors with Optional Curved Blade



SC140/SC140C

50 mm	145 mm	10 SC140
50 mm	145 mm	10 SC140C

Special Tin Forceps with Finely Serrated Jaws



2705R

160 mm	1 2705R



KNIVES

ERGO™ Retractable Utility Knives



ergo



KERU01

170 mm	26 mm	5 KERU-01

ERGO™ Fixed Utility Knives



ergo



KEFU01

170 mm	26 mm	5 KEFU-01

ERGO™ Snap Off Utility Knives with 18 mm Blades



ergo



KE18-01

161 mm	26 mm	5 KE18-01

Retractable Utility Knives with TPR Grip



KBRU-01

170 mm	26 mm	5 KBRU-01

Retractable Utility Knives



KGRU-01

160 mm	26 mm	5 KGRU-01

Retractable Twist Utility Knives



KGRU-02

145 mm	26 mm	5 KGRU-02

Mini Retractable Utility Knives



KMU-01

90 mm	26 mm	5 KMU-01

Squeeze Retractable Utility Knives with Rubber Grip



SQZ150003

170 mm	60 mm	6 SQZ150003

Fixed Utility Knives with TPR grip



KBFU-01

170 mm	26 mm	5 KBFU-01

Fixed Utility Knives



KGFU-01

160 mm	26 mm	5 KGFU-01

Trapezoidal Blades for Utility Knives - 100 Pcs



KBGU



0.635 x 19 x 60 mm



1 KBGU-100P

Hook Trapezoidal Blades for Utility Knives - 5 Pcs/Dispenser



KBGH-5P-DISPEN



0.635 x 19 x 51 mm



20 KBGH-5P-DISPEN

Snap Off Utility Knives with TPR Grip and 9 mm Blades



KB09-01



140 mm



5 KB09-01

Trapezoidal Blades for Utility Knives - 5 Pcs/Dispenser



KBGU-5P-DISPEN



0.635 x 19 x 60 mm



20 KBGU-5P-DISPEN

Safety Trapezoidal Blades for Utility Knives - 5 Pcs/Dispenser



KBGR-5P-DISPEN



0.635 x 19 x 55 mm



20 KBGR-5P-DISPEN

Snap Off Utility Knives with TPR Grip and 18 mm Blades



KB18-01



160 mm



5 KB18-01

Trapezoidal Blades for Utility Knives - 10 Pcs/Dispenser



KBGU-10P-DISPEN



0.635 x 19 x 60 mm



20 KBGU-10P-DISPEN

Trapezoidal Hook Blades for SQZ150003 Utility Knives



SQZ150003-HSBL



51 mm



6 SQZ150003-HSBL

Snap Off Utility Knives with 9 mm Blades



KG09-01



140 mm

140 mm



5 KG09-01

10 KG09-01-3P



Snap Off Utility Knives with 18 mm Blades



KG18-01



160 mm



5 KG18-01

Blades for Utility Knives 18 mm - 5 Pcs/
Dispenser



KUBG18-5DISPEN



15 x 30 x 130 mm



20 KUBG18-5DISPEN

Holsters for Fixed Utility Knives



KHU-01



90 g



4 KHU-01

Snap Off Blades for Utility Knives 9 mm -
10 Pcs/Dispenser



KSBG09-10DISPEN



1 x 9 x 85 mm



20 KSBG09-10DISPEN

Snap Off Blades for Utility Knives 18 mm -
10 Pcs/Dispenser



KSBG18-10DISPEN



15 x 30 x 130 mm



20 KSBG18-10DISPEN

Mini Squeeze Retractable Utility Knives
with Rubber Grip



SQZ-MINI



160 mm



24 SQZ-MINI

Blades for Utility Knives - 5 Pcs/Retail
Pack

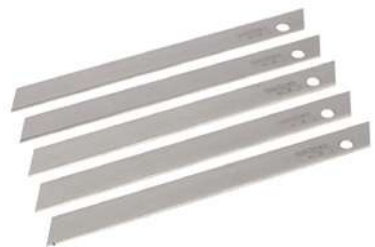

KUBG



0.7 x 85 x 9 mm



20 KUBG09-5P

Auto Retractable Safety Utility Knives



KGAU-01



160 mm



5 KGAU-01

Trapezoidal Mini Squeeze Blades for SQZ-
MINI Utility Knife



SQZ-MINI-BLADE



28 mm



1 SQZ-MINI-BLADE

BAHCO

Sports Foldable Utility Knives with Aluminium Handle and Twin Blades



KBTU-01



5 KBTU-01

Sports Foldable Utility Knives with Polyamide Handle



KGSU-01



5 KGSU-01

Multipurpose Tradesman Stainless-Steel Knives with Dual-Component Handle -15 Pcs/Counter Display



2446-BL

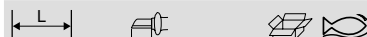

218 mm 102 mm 15 2446-BL

Sports Foldable Knives for Rope Cutting



KBSK-01



5 KBSK-01

Tradesman Laplander Knives with Dual-Component Green Handle



2446-LAP



218 mm 102 mm 15 2446-LAP
218 mm 102 mm 10 SB2446-LAP

SB: Retail packed

Multipurpose Tradesman Knives with Dual-Component Handle and Safety Blunt Tip



2446-SAFE

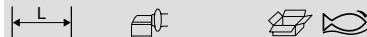

215 mm 95 mm 15 2446-SAFE

Sports Foldable Utility Knives with Aluminium Handle



KBSU-01



5 KBSU-01

Multipurpose Tradesman Knives with Dual-Component Handle and Double Button Holster



2446



225 mm 100 mm 15 2446

Tradesman Knives for Lino Carpets - 12 Pcs/Counter Display



2446-LINO

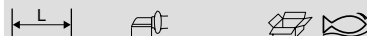

180 mm 55 mm 12 2446-LINO



Electrician Stripping Knives for Both Hands Use



2446-EL

32 mm	150 mm	12	2446-EL

Tradesman Electrician's Stripping Knives for Right Hand Use



2446-ELR

34 mm	145 mm	12	2446-ELR

Multipurpose Tradesman Knives with 1-Component Handle - 15 Pcs/Counter Display



1446

220 mm	100 mm	15	1446

Electrician Stripping Knives for Both Hands Use Retail Pack



SB2446-EL

150 mm	32 mm	10	SB2446-EL

Multipurpose Tradesman Knives with Dual-Component Handle and Special Holster



2446-OV

220 mm	100 mm	15	2446-OV

Multipurpose Tradesman Carbon Steel Knives with Single Component Handle - 15 Pcs/Counter Display



1446-CS

218 mm	102 mm	15	1446-CS

Tradesman Electrician's Stripping Knives for Left Hand Use



2446-ELL

34 mm	145 mm	12	2446-ELL

Tradesman Electrician's Knives with Guide



2446-EL-HELP

43 mm		12	2446-EL-HELP

Rescue floating knife with fluorescent handle with holster



1446-FLOAT

226 mm	102 mm	15	1446-FLOAT

Floating Knife with fluorescent handle



1446-FLOAT-B



225 mm 100 mm 12 1446-FLOAT-B

Without holster

Bucket for 1446 Knives



BUCKET 1446



25 l 75 BUCKET 1446

BUCKET - EMPTY

1446x 75

Empty bucket



BUCKET-EMPTY



25 l 6 BUCKET - EMPTY

Bucket for 1446-CS Knives



BUCKET-1446-CS

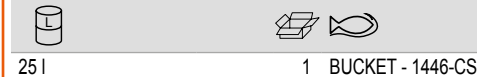

25 l 1 BUCKET - 1446-CS

BUCKET - EMPTY

1446-CSx 75

Bucket for 1446-FLOAT Knives



BUCKET-1446-FLOAT



25 l 1 BUCKET-1446-FLOAT

BUCKET - EMPTY

1446-FLOATx 75

Multipurpose Tradesman Knives with 1-Component Handle and Special Holster



1446-OV



225 mm 100 mm 15 1446-OV

Electricians Pinch Knives with Wooden Handle



2820EK-01



25 mm 130 mm 12 2820EK-01

Electricians Knives with 70 mm Serrated Blades



2820EK



95 mm 205 mm 6 2820EK

Electricians Folding Knives with 60 mm Blades



2820EF1



90 mm 200 mm 12 2820EF1



Electricians Folding Knives with 65 mm Blades



2820EF2

85 mm	195 mm	8	2820EF2

18-in-1 Aluminium Foldable Multitools



MTT151

150 mm	6	MTT151

Windows Scraper with Interchangeable Blade



KRSS-01

80 g	10	KRSS-01

Electricians Folding Knives with 70 mm Blades



2820EF3

80 mm	170 mm	1	2820EF3

18-in-1 Aluminium Mini Foldable Multitools



MTT121

110 mm	8	MTT121

Windows Scrapers with Dual-Component Plastic Body



KBWS-01

70 g	10	KBWS-01

Electricians Folding Knives with 70/85 mm Double Blades



2820EF4

75-85 mm	170 mm	1	2820EF4

12-in-1 Aluminium Foldable Multitools



MTT051

165 mm	6	MTT051



Clamps & Vices



CLAMPS

Quick Clamps with 200 kg Force



QCB

L	QCB
456 mm	6 QCB-150
606 mm	6 QCB-300
756 mm	6 QCB-450
906 mm	4 QCB-600
1206 mm	4 QCB-900
1556 mm	8 QCB-1250

Quick Clamps with 125 kg Force



QCG

L	QCG
380 mm	6 QCG-150
530 mm	6 QCG-300

High Resistance Quick Clamps with 70 kg Maximum Force



QC

X	L	QC
1	230 mm	12 QC-115A
2	230 mm	6 QC-115A-2P
1	305 mm	6 QC-150A
2	305 mm	6 QC-150A-2P
1	475 mm	6 QC-300A
2	475 mm	4 QC-300A-2P

-2P: Twin Pack

F-Clamps with Steel T-Handle 90 mm



3066

L	T-Handle	3066
250 mm	90 mm	5 306601500
300 mm	90 mm	5 306602000
400 mm	90 mm	5 306603000
510 mm	90 mm	5 306604000

F-Clamps with Steel T-Handle 120 mm



3067

L	T-Handle	3067
415 mm	125 mm	5 306703000
510 mm	125 mm	5 306704000
610 mm	125 mm	5 306705000
710 mm	125 mm	5 306706000
910 mm	125 mm	5 306708000
1115 mm	125 mm	5 306710000
1310 mm	125 mm	2 306712000
1610 mm	125 mm	2 306715000

F-Clamps with Steel T-Handle 150 mm



3068

L	T-Handle	3068
430 mm	155 mm	5 306803000
535 mm	155 mm	5 306804000
640 mm	155 mm	2 306805000
730 mm	155 mm	2 306806000
820 mm	155 mm	2 306808000
1135 mm	155 mm	2 306810000
1335 mm	155 mm	2 306812000
1630 mm	155 mm	1 306815000
2130 mm	155 mm	1 306820000

F-Clamps with Steel T-Handle 220 mm



3069

L	T-Handle	3069
430 mm	225 mm	2 306903000
540 mm	225 mm	2 306904000
638 mm	225 mm	2 306905000
730 mm	225 mm	2 306906000
932 mm	225 mm	2 306908000
1130 mm	225 mm	2 306910000

F-Clamps with Rubberised Handle



420SH

L	T-Handle	420SH
100 mm	50 mm	10 420SH-50-100
200 mm	50 mm	10 420SH-50-200
120 mm	60 mm	12 420SH-60-120
300 mm	60 mm	12 420SH-60-300
160 mm	80 mm	12 420SH-80-160
200 mm	100 mm	10 420SH-100-200
250 mm	120 mm	8 420SH-120-250
300 mm	120 mm	8 420SH-120-300
400 mm	120 mm	6 420SH-120-400
500 mm	120 mm	6 420SH-120-500
600 mm	120 mm	6 420SH-120-600
800 mm	120 mm	6 420SH-120-800
1000 mm	120 mm	6 420SH-120-1000
1250 mm	120 mm	6 420SH-120-1250
1500 mm	120 mm	6 420SH-120-1500
400 mm	140 mm	6 420SH-140-400
400 mm	175 mm	6 420SH-175-400

Handy Spring Clamps with Movable Gripping Surface



420SC

	g		
25 mm	60 g	10	420SC-25
50 mm	120 g	5	420SC-50

Heavy Duty Round Guide Bench Vices with Interchangeable Jaws, Suitable for Swivel Base



6010

80 mm		1	601000800
100 mm		1	601001000
125 mm		1	601001250
150 mm		1	601001500

Pair of Spare Pipe Jaw Set for 834V-4, 834V-7 & 6072 Bench Vices



833P

100 mm		1	833PJ-4
125 mm		1	833PJ-5
150 / 175 mm		1	833PJ-67

BENCH VICES

Heavy Duty Square Guide Bench Vices with Interchangeable Jaws



834V

100 mm		1	834V-4
125 mm		1	834V-5
150 mm		1	834V-6
175 mm		1	834V-7

Slide adjustment screw to regulate the looseness with pipe holding jaws

Round Guide Portable Bench Vices with Interchangeable Jaws



834V-2

63 mm		1	834V-2

Spare Spindles and Nuts for 6072 and 834V Bench Vices



6070H

100 mm		1	6070H1000
125 mm		1	6070H1250
150 mm		1	6070H1500
175 mm		1	6070H1750

Heavy Duty Square Guide Bench Vices with Interchangeable Jaws, Suitable for Swivel Base



6072

100 mm		1	607201000
125 mm		1	607201250
150 mm		1	607201500
175 mm		1	607201750

Pair of Spare Jaws and Screws for 6072 and 834V Bench Vices



6072M

100 mm	834V-4, 607201000	1	6072M1000
150 mm	834V-6, 607201500	1	6072M1500
175 mm	834V-7, 607201750	1	6072M1750

125 mm size jaw common for round & square models

Pair of Spare Jaws and Screws for 6010 Bench Vice



6010M

80 mm	601000800	1	6010M0800
100 mm	601001000	1	6010M1000
125 mm	834V-5, 607201250, 601001250	1	6010M1250
150 mm	601001500	1	6010M1500



125 mm size jaw common for round & square models



Spare Spindles and Bolts for 6010 Bench Vice





6010H

		
80 mm	1	6010H0800
100 mm	1	6010H1000
125 mm	1	6010H1250
150 mm	1	6010H1500

Pair of Spare Aluminium Jaws with magnetic strip



833AJ

		
100 mm	1	833AJ-4
125 mm	1	833AJ-5
150 mm	1	833AJ-6

Pair of Spare Jaws for 834V-2 Table Vice





6040M/H

		
63 mm	1	6040M0630

Pair of Spare Polyurethane Jaws with magnetic strip



833FJ



		
100 mm	1	833FJ-4
125 mm	1	833FJ-5
150 mm	1	833FJ-6

BENCH VICE ACCESSORIES

Swivel Bases for 6010/6072 and 834V Bench Vices



833SB

			
80 mm	100 mm	1	833SB-4
100 mm	125 mm	1	833SB-5
125 mm	150 mm	1	833SB-6
150 mm	175 mm	1	833SB-7



Hammers



CLAW HAMMERS

ERGO™ Claw Hammers with Rubber Grip



ergo



529

450 g	4	529-16-L
450 g	4	529-16-XL
570 g	4	529-20-L
570 g	4	529-20-XL

ERGO™ Straight Claw Hammers with Bi-Material Rubber Grip



ergo



529S

450 g	4	529S-16-XL
570 g	4	529S-20-XL

Claw Hammers with Rubber Grip Steel Tube Handle



429

230 g	4	429-8
370 g	4	429-13
450 g	4	429-16
570 g	4	429-20

Claw Hammers with Rubber Grip Fibreglass Handle



428

450 g	4	428-16

Claw Hammer rubber grip with curved nails



428F

230 g	4	428F-8
370 g	4	428F-13
454 g	4	428F-16
567 g	4	428F-20
680 g	4	428F-24

Claw Hammer rubber grip with RIP nails



428S

454 g	4	428S-16
567 g	4	428S-20

Claw Hammers with Anti-Slip Surface Wooden Handle



427

370 g	4	427-13
680 g	4	427-24
230 g	4	427-8
450 g	4	427-16
570 g	4	427-20

Claw Hammer with RIP nails and polish head



427S

454 g	4	427S-16
567 g	4	427S-20

Spanish Style Claw Hammers with Dotted Grip Hickory Handle



427

700 g	6	427-700

Spanish Style Claw Hammers with Rubber Grip Tri-Material Handle



428

700 g	6	428-700

NAIL PULLERS

Compact Nail Pullers with Thermoplastic Handle



36

220 mm	5	36

ENGINEERING HAMMERS

Ball Pein Hammers with Hickory Handle



479

230 g	6	479-08
340 g	6	479-12
450 g	6	479-16
570 g	6	479-20
800 g	6	479-24
900 g	6	479-32

Ball Pein hammer with fiberglass Handle



479F

230 g	6	479F-08
340 g	6	479F-12
450 g	6	479F-16
570 g	6	479F-20
680 g	6	479F-24
900 g	6	479F-32

German DIN Locksmith's Hammers



481

100 g	6	481-100
200 g	6	481-200
300 g	6	481-300
400 g	6	481-400
500 g	6	481-500
800 g	6	481-800
1000 g	6	481-1000
1500 g	6	481-1500
2000 g	6	481-2000

German DIN Hammer Fiberglass Handle



481F

100 g	6	481F-100
200 g	4	481F-200

300 g	6	481F-300
400 g	6	481F-400
500 g	6	481F-500
800 g	6	481F-800
1000 g	6	481F-1000
1500 g	4	481F-1500
2000 g	4	481F-2000

Rivoir Hammers French Pattern with Anti-Sliding Handle



482

300 g	6	482-25
400 g	6	482-28
500 g	6	482-30
800 g	6	482-35
1000 g	6	482-40
1500 g	6	482-45

Rivoir Hammer Fiberglass Handle



482F

300 g	4	482F-25
400 g	4	482F-28
470 g	6	482F-30
800 g	4	482F-35
1000 g	2	482F-40
1500 g	4	482F-45



Warrington Hammers English Joiner's with Cross Pein



480

230 g	4	480-08
280 g	6	480-10
340 g	6	480-12
400 g	4	480-14
570 g	4	480-20

Carpenter Hammers Spike Claw with Forged Head



485W

650 g	6	485W-650
750 g	6	485W-750
	1	SH-485W
	1	SH-485W-PLATES

Cross Pein Pin Hammers with Hickory Handle



490

100 g	4	490-3.5

Pattern Makers Hammers with Ball Pein and Hickory Handle



492

100 g	6	492-3.5

Joiner's Hammers French Pattern



483

100 g	6	483-16
160 g	6	483-20
200 g	6	483-22
300 g	6	483-25
400 g	6	483-28

Club Hammers with Hickory Handle



484

1000 g	6	484-1000
1250 g	6	484-1250
1500 g	6	484-1500
2000 g	4	484-2000

CONSTRUCTION HAMMERS

Carpenter Hammers Spike Claw with Tubular Steel Shaft



485

600 g	6	485

Joiner Hammer Fiberglass Handle



483F

100 g	6	483F-16
160 g	6	483F-20
200 g	6	483F-22
300 g	6	483F-25
400 g	6	483F-28
500 g	4	483F-30

Club Hammer Fiberglass Handle



484F

1000 g	6	484F-1000
1250 g	6	484F-1250
1500 g	6	484F-1500
2000 g	4	484F-2000

Club Hammers Spanish Type with Oval Eye



407

700 g	5	407-700
1000 g	6	407-1000
1400 g	6	407-1400

Square Head Sledge Hammers with Tri-Material Handle



488F

2000 g	2	488F-2000
3000 g	2	488F-3000
4000 g	2	488F-4000
5000 g	4	488F-5000
6000 g	2	488F-6000

Spanish Type Bricklayer's Hammers with Fibreglass Handle



486F

700 g	6	486F-700

Club Hammers with Fibreglass Handle



407F

700 g	6	407F-700
1000 g	6	407F-1000
1400 g	6	407F-1400

Bricklayer's Hammers with Hickory Handle



486W

500 g	4	486W-500
600 g	4	486W-600
	1	SH-486W

Bricklayer's Hammers with Rubber Grip



486

600 g	4	486

Square Head Sledge Hammers with Hickory Handle



488

2000 g	2	488-2000
3000 g	2	488-3000
4000 g	2	488-4000
5000 g	2	488-5000
6000 g	1	488-6000

Spanish Type Bricklayer's Hammers with Hickory Handle



486-700

700 g	6	486-700

Mason's Pin with Pointed Tip



4401

255 mm	10	440102500
300 mm	10	440103000



Spare Wooden Handles for Hammers



WSH



407	1	SH-407
491-3000 & 491-4000	12	SH-491-34
491-5000 & 491-6000	12	SH-491-56
488-2000	10	SH-488-2000
488-3000, 488-4000	10	SH-488-34
488-5000, 488-6000	10	SH-488-56
427-700	10	SH-427-700
486-700, 495-500, 495-600, 493-500, 493-600	10	SH-486-493-495

Spanish Type Shovel-Hatchets with Fibreglass Handle



493F



500 g	6	493F-500
600 g	1	493F-600

Plasterer's Hatchets with Tubular Steel Shaft



494



600 g	4	494-600
-------	---	---------

Fibreglass Spare Handles



FSH



488f-2000	10	SH-488F-2000
488F-3000 & 488F-4000	1	SH-488F-34
488F-5000 & 488F-6000	1	SH-488F-56
428-700	10	SH-428-700
486F-700, 495F-500, 495F-600, 493F-500, 493F-600	10	SH-486F493F495F

Spanish Type Shovel-Picks with Hickory Handle



495



500 g	6	495-500
600 g	6	495-600

Anti Rebound Hammers with Wooden Handle



3625AR



550 g	34	3625AR-35
1430 g	18	3625AR-50
1550 g	12	3625AR-60

SPECIALTY HAMMERS

Spanish Type Shovel-Hatchets with Wooden Handle



493



500 g	6	493-500
600 g	6	493-600

Spanish Type Shovel-Picks with Fibreglass Handle



495F



500 g	6	495F-500
600 g	1	495F-600

Spare Tips for 3625AR Hammers



3625ARL



35 mm	3625AR-35	6	3625ARL-35
50 mm	3625AR-50	6	3625ARL-50
60 mm	3625AR-60	6	3625ARL-60

Spare Handle for 3625AR Hammers



3625ARLH

3625AR-35	290 mm	80	3625ARLH-35	
3625AR-60	300 mm	50	3625ARLH-50	
3625AR-60	390 mm	16	3625ARLH-60	

Pein Sledge Hammers with Hickory Handle



491

3000 g	4	491-3000	
4000 g	4	491-4000	
5000 g	4	491-5000	
6000 g	4	491-6000	

SOFT FACE HAMMERS & MALLETS

Thermoplastic Polyurithane Hammers



3625Y

120 g	6	3625Y-22
225 g	6	3625Y-32
372 g	6	3625Y-40
484 g	6	3625Y-50

Dead Blow Sledge Hammers with Anti-Sliding Handle



3625PU

300 g	12	3625PU-30
790 g	6	3625PU-50
1080 g	6	3625PU-60

99/105 mm Safety Sledge Hammers with Rubber Handle



489-1100/489-1800

1100 g	8	489-1100
1800 g	8	489-1800

Polyflex Plastic Hammers



3625YL

3625Y-22	22 mm	20	3625YL-22
3625Y-32	32 mm	20	3625YL-32
3625Y-40	40 mm	20	3625YL-40
3625Y-50	50 mm	20	3625YL-50

Dead Blow Sledge Hammers with Anti-Sliding Handle 105 mm



3625PU-105

5000 g	5600 g	4	3625PU-105

150/190 mm Safety Sledge Hammers with Rubber Handle



489-2700/489-5400

2700 g	4	489-2700
3600 g	4	489-3600
4500 g	4	489-4500
5400 g	4	489-5400

Superflex Plastic Hammers with Wooden Handle



3625N

120 g	6	3625N-22
225 g	6	3625N-32
372 g	6	3625N-40
484 g	6	3625N-50



Pairs of Poll for 3625N Superflex Plastic Hammers



3625NL

3625N-22	22 mm	20	3625NL-22	
3625N-32	32 mm	20	3625NL-32	
3625N-40	40 mm	20	3625NL-40	
3625N-50	50 mm	20	3625NL-50	

Spare Handle for 3625W Hammers



3625WLH

3625W-22	50	3625WLH-22	
3625W-28	50	3625WLH-28	
3625W-35	80	3625WLH-35	
3625W-44	50	3625WLH-44	
3625W-55	16	3625WLH-55	

Rubber Mallets with Wooden Handle



3625RM

290 g	50	3625RM-55
460 g	40	3625RM-65
660 g	30	3625RM-75
850 g	20	3625RM-90

Nylon Tip Mallets with Wooden Handle



3625W

150 g	120	3625W-22
250 g	1	3625W-28
490 g	1	3625W-35
1050 g	1	3625W-44
1470 g	12	3625W-55

Nylon Tip Mallets with Rubber Grip



3625S

350 g	50	3625S-28
610 g	30	3625S-35
1100 g	18	3625S-44

Copper Sledge Hammers with Soft Face



4130

500 g	12	413005000
1000 g	12	413010000
1500 g	12	413015000
2000 g	6	413020000
3000 g	1	413030000
4000 g	1	413040000

Pairs of Poll for 3625W and 3625S Nylon Tipped Mallets



3625WL

3625W-22	22 mm	10	3625WL-22	
3625W-28, 3625S-28	28 mm	10	3625WL-28	
3625W-35, 3625S-35	35 mm	10	3625WL-35	
3625W-44, 3625S-44	44 mm	10	3625WL-44	
3625W-55	55 mm	6	3625WL-55	



Tree Felling & Forestry Tools



AXES, HATCHETS & MAULS

Camping Axes with Curved Ash Wood Handle and Yankee Pattern 380 mm-500 mm



HUS

Length	Weight (g)	Quantity	Model
380 mm	770 g	4	HUS-0.6-380
500 mm	1080 g	4	HUS-0.8-500

Camping Axes with Curved Ash Wood Handle



HGPS

Length	Weight (g)	Quantity	Model
380 mm	944 g	4	HGPS-0.8-380-WB
400 mm	1130 g	4	HGPS-1.0-400-WB
360 mm	790 g	10	HGPS-0.6-360
380 mm	1020 g	4	HGPS-0.8-380
400 mm	1260 g	4	HGPS-1.0-400

Camping Axes with Curved Ash Wood Handle and Yankee Pattern 650 mm



HUS-1.0-650

Length	Weight (g)	Quantity	Model
650 mm	1380 g	4	HUS-1.0-650

Camping Axes with Fibreglass Handle and French Pattern Blade



HFGPS

Length	Weight (g)	Quantity	Model
380 mm	1010 g	4	HFGPS-0,7-400FG

Felling Axes with Curved Ash Wood Handle 800 mm



FGS-810

Length	Weight (g)	Quantity	Model
800 mm	2260 g	4	FGS-1.6-810
800 mm	2460 g	4	FGS-1.8-810

Felling Axes with Hickory Wood Handle and Canadian Style



FCP

Length	Weight (g)	Quantity	Model
800 mm	2500 g	4	FCP-1.8-810
850 mm	3000 g	2	FCP-2.3-860

Felling Axes with Curved Ash Wood Handle 600 mm-700 mm



FGS

Length	Weight (g)	Quantity	Model
700 mm	1730 g	4	FGS-1.25-700-WB
810 mm	2210 g	4	FGS-1.6-810-WB
600 mm	1400 g	4	FGS-1.0-600
700 mm	1850 g	4	FGS-1.25-700

Felling Axes with Fibreglass Handle and French Style



FFSS

Length	Weight (g)	Quantity	Model
900 mm	2400 g	4	FFSS-1.5-900FG

Splitting Axes with Curved Ash Wood Handle



SUS

Length	Weight (g)	Quantity	Model
800 mm	2600 g	4	SUS-2.0-800

Splitting Axes with Hickory Wood Handle



MCP

Length	Weight (g)	Quantity	Model
800 mm	3280 g	2	MCP-2.5-810

Mauls/Sledges with Ash Wood/3-Component Handle and Two Flat Face



LS-MASSE

Length	Weight (g)	Quantity	Model
900 mm	4800 g	2	LS-MASSE-4FG
900 mm	4640 g	2	LS-MASSE-4

Mauls/Sledges with 3-Component Handle and One Flat Face



LS-MASSE-TR

Length	Weight (g)	Quantity	Product Code
900 mm	4840 g	2	LS-MASSE-TR-4FG

Splitting Axes with Ash Wood/3-Component Handle



MES

Length	Weight (g)	Quantity	Product Code
900 mm	4250 g	2	MES-3.5-900
900 mm	4310 g	2	MES-3.5-900FG

Spare Ash Wood Handles for Pick Axes



SH

Length	Quantity	Product Code
800 mm	1	SH-FCS-810
900 mm	1	SH-FCS-860
600 mm	1	SH-FGS-600
700 mm	12	SH-FGS-700
800 mm	1	SH-FGS-800
900 mm	1	SH-FGS-1.8-810
375 mm	1	SH-HFGPS-400FG
400 mm	1	SH-HGPS-400
900 mm	12	SH-MES-F-900
360 mm	12	SH-HGPS-360
380 mm	1	SH-HGPS-380
380 mm	1	SH-HUS-380
500 mm	1	SH-HUS-500
650 mm	1	SH-HUS-650
900 mm	12	SH-MES-900
915 mm	12	SH-MES-900FG
800 mm	12	SH-SUS-800
800 mm	1	SH-MCS-800
905 mm	1	SH-FCP-860

Pick Axes with Fibreglass Handle for Construction Work



PAGS-2.0-900FG

Length	Weight (g)	Quantity	Product Code
900 mm	3000 g	1	PAGS-2.0-900FG

Pick Axes Heads with Round Eye for Construction Work



PAGS

Length	Weight (g)	Quantity	Product Code
450 mm	2000 g	1	PAGS-2.0

Splitting Axes with Ash Wood/3-Component Handle and One Flat Face



LS/MES

Length	Weight (g)	Quantity	Product Code
900 mm	3390 g	2	LS-MERLIN-2.5
900 mm	3330 g	2	LS-MERLIN-2.5FG
900 mm	3580 g	2	MES-3.0-900

Ash Wood/Fibreglass Spare Handles for Pick Axes with Round Eye



SH-PAGS

Length	Weight (g)	Quantity	Product Code
900 mm	690 g	1	SH-PAGS-900
920 mm	1030 g	1	SH-PAGS-900FG

WEDGES

Synthetic Felling Wedges



LS-COIN

Length	Weight (g)	Quantity	Product Code
260 mm	295 g	2	LS-COIN 26 CM
190 mm	170 g	4	LS-COIN 19 CM

Twisted Steel Splitting Wedges



WT

Length	Weight (g)	Quantity	Product Code
220 mm	2000 g	4	W-T-2.0

Traditional Steel Splitting Wedges



WS

Length	Weight (g)	Quantity	Product Code
220 mm	1500 g	4	W-S-1.5
250 mm	2000 g	4	W-S-2.0
260 mm	2500 g	4	W-S-2.5





BAHCO



Cold Chisels & Punches



COLD CHISELS

Flat Cold Chisels with Octagonal Shank, Plastic Covered



3656

L	W	Q	Part No.
129 mm	12 mm	50	3656-125
155 mm	16 mm	50	3656-150
178 mm	19.5 mm	1	3656-175

Cold Chisels with Flat Oval Shank and Phosphate Finish



3640

L	W	Q	Part No.
150 mm	18 mm	25	3640-150-C
200 mm	22 mm	25	3640-200-C
250 mm	28 mm	20	3640-250-C
300 mm	26 mm	25	3640-300-C

Cold Cape Chisels with Flat Oval Shank and Lacquered Copper Finish



3745

L	W	Q	Part No.
150 mm	6 mm	50	3745-150
175 mm	7 mm	25	3745-175
200 mm	8 mm	20	3745-200
250 mm	9 mm	10	3745-250

Cold Chisels with Flat Oval Shank and Lacquered Copper Finish



3740

L	Q	Part No.
100 mm	50	3740-100
125 mm	50	3740-125
150 mm	50	3740-150
175 mm	25	3740-175
200 mm	25	3740-200
250 mm	10	3740-250
300 mm	10	3740-300

Flat Cold Chisels with Octagonal Shank and Lacquered Copper Finish



3756

L	W	Q	Part No.
125 mm	10 mm	50	3756-125
150 mm	12 mm	50	3756-150

Cold Cape Chisel with Octagonal Shank and Lacquered Copper Finish



3749

L	W	Q	Part No.
125 mm	10 mm	50	3749-125

Cold Chisels with Flat Oval Shank and Lacquered Copper Finish Retail Pack



SB-3740

L	Q	Part No.
125 mm	87	SB-3740-125
150 mm	25	SB-3740-150
175 mm	25	SB-3740-175
200 mm	25	SB-3740-200
250 mm	25	SB-3740-250
300 mm	25	SB-3740-300

Cold Cape Chisels with Flat Octagonal Shank, Plastic Covered



3649

L	W	Q	Part No.
128 mm	12 mm	50	3649-125

Slitting Chisels with Flat Oval Shank and Lacquered Copper Finish



3750

L	W	Q	Part No.
240 mm	26 mm	25	3750

Mason's Chisels with Octagonal Shank and Lacquered Copper Finish



3736M

L		Icons	
200 mm	30	3736M-200	
250 mm	25	3736M-250	
300 mm	10	3736M-300	
400 mm	10	3736M-400	

Pointed Chisels with Octagonal Shank and Lacquered Copper Finish



3739-250 / -400

L		Ø	Icons	
250 mm	16 mm	25	3739-250	
300 mm	18 mm	10	3739-300	
400 mm	18 mm	10	3739-400	

Pointed Chisels with Octagonal Shank and Guard



3739H

L		Ø	Icons	
250 mm	16 mm	15	3739H-250	
300 mm	18 mm	10	3739H-300	
400 mm	18 mm	10	3739H-400	

Mason's Chisels with Long Flat Shank



8740

L		Icons	
200 mm	5	874002000	
250 mm	5	874002500	
300 mm	5	874003000	
350 mm	5	874003500	
400 mm	5	874004000	
500 mm	5	874005000	

COLD CHISELS WITH GUARD

Slitting Chisels with Flat Oval Shank and Guard



3750H

L		Icons	
240 mm	25	3750H	

COLD CHISELS, REGRINDABLE

Regrindable Cold Chisels with Flat Shank and Guard



8741

L		Icons	
200 mm	6	874102000	
250 mm	5	874102500	
300 mm	5	874103000	
350 mm	4	874103500	
400 mm	5	874104000	

Mixed Chisel Set with Lacquered Copper Finish - 6 Pcs/Box



3736S/6

g	Icons	
840 g	5	3736S/6

3735-4-120, 3735-5-150

3733-3

3749-125

3756-125, 3756-150

Mason's Chisels with Octagonal Shank and Guard



3736MH

L		Icons	
250 mm	10	3736MH-250	
300 mm	10	3736MH-300	
400 mm	5	3736MH-400	

Regrindable Pointed Chisels with Octagonal Shank



8746

L		Ø	Icons	
200 mm	14 mm	5	874602000	
250 mm	14 mm	5	874602500	
300 mm	16 mm	5	874603000	
350 mm	16 mm	5	874603500	
400 mm	18 mm	5	874604000	



Electrician Regrindable Chisels with Octagonal Shank



8760

L	Icon	Icon
200 mm	10	876002000
250 mm	5	876002500

Regrindable Cold Chisels with Extra Flat Shank



8770

L	Icon	Icon
240 mm	25	877002400

COLD CHISELS ACCESSORIES

Handles for Cold Chisels



8749

Icon	Icon	Icon
16x16 mm	1	874916X16
18x18 mm	1	874918X18
23x13 mm	1	874923X13
26x7 mm	1	874926X7

PUNCHES

Centre Punches with Octagonal Shank and Hand Protection



3643

Icon	L	Icon	Icon
3 mm	100 mm	50	3643-100
4 mm	120 mm	50	3643-120
5 mm	120 mm	50	3643-150

Centre Punches with Octagonal Shank and Lacquered Copper Finish



3735

Icon	L	Icon	Icon
4 mm	120 mm	50	3735-4-120
5 mm	120 mm	50	3735-5-120
5 mm	150 mm	50	3735-5-150

Centre Punches with Hexagonal Shank and Chrome Finish



3735N

Icon	L	Icon	Icon
2 mm	100 mm	10	3735N-2-100
4 mm	120 mm	10	3735N-4-120
5 mm	120 mm	10	3735N-5-120
6 mm	150 mm	10	3735N-6-150
8 mm	150 mm	10	3735N-8-150
2 mm	100 mm	1	SB-3735N-2-100
4 mm	120 mm	60	SB-3735N-4-120
5 mm	120 mm	1	SB-3735N-5-120
6 mm	150 mm	1	SB-3735N-6-150
8 mm	150 mm	1	SB-3735N-8-150

SB: With hanging clip

Centre Punch Set with Chrome Finish - 4 Pcs/Wallet



3735NS/4

g	Icon	Icon
340 g	25	3735NS/4

3735N-6-150, 3735N-8-150, 3735N-2-100, 3735N-4-120

Automatic Centre Punches with Hardened Steel Point



1157

Icon	L	Icon	Icon
2 mm	130 mm	60	1157

Drift Punches with Octagonal Shank and Hand Protection



3644

Icon	L	Icon	Icon
2 mm	120 mm	50	3644-120
3 mm	125 mm	50	3644-125
4 mm	130 mm	50	3644-130
4 mm	150 mm	50	3644-150
5 mm	165 mm	50	3644-165
6 mm	180 mm	50	3644-180
8 mm	200 mm	50	3644-200

Cylindrical Drift Punches with Knurled Guide Sleeve



3659

Ø	L	Icons	Part No.
0.9 mm	70 mm	5	3659-0.9
1.4 mm	81 mm	5	3659-1.4
1.8 mm	84 mm	5	3659-1.8
2.4 mm	92 mm	5	3659-2.4
2.8 mm	95 mm	5	3659-2.8
3.4 mm	97 mm	5	3659-3.4
3.9 mm	100 mm	5	3659-3.9
5.9 mm	100 mm	5	3659-6.0

Cylindrical Drift Punches with Octagonal Shank and Hand Protection



3658A

Ø	L	Icons	Part No.
2 mm	150 mm	125	3658A-2
3 mm	150 mm	125	3658A-3
4 mm	150 mm	125	3658A-4
5 mm	150 mm	125	3658A-5
6 mm	150 mm	125	3658A-6
8 mm	150 mm	50	3658A-8

Ø	L	Icons	Part No.
8 mm	150 mm	10	3734N-8-150
9 mm	150 mm	10	3734N-9-150
10 mm	150 mm	10	3734N-10-150
2 mm	150 mm	1	SB-3734N-2-150
3 mm	150 mm	1	SB-3734N-3-150
4 mm	150 mm	60	SB-3734N-4-150
5 mm	150 mm	1	SB-3734N-5-150
6 mm	150 mm	60	SB-3734N-6-150
7 mm	150 mm	1	SB-3734N-7-150
8 mm	150 mm	1	SB-3734N-8-150
10 mm	150 mm	1	SB-3734N-10-150

Conical Drift Punches with Octagonal Shank and Lacquered Copper Finish



3733

Ø	L	Icons	Part No.
2 mm	120 mm	50	3733-2
3 mm	120 mm	50	3733-3
4 mm	120 mm	50	3733-4
5 mm	120 mm	50	3733-5
6 mm	120 mm	50	3733-6

Cylindrical Drift Punches with Octagonal Shank and Lacquered Copper Finish



3734

Ø	L	Icons	Part No.
2 mm	150 mm	50	3734-2
3 mm	150 mm	50	3734-3
4 mm	150 mm	50	3734-4
5 mm	150 mm	50	3734-5
6 mm	150 mm	50	3734-6
8 mm	150 mm	50	3734-8

Fine Grounded Pin Drift Punch Set with Hand Protection - 6 Pcs/Wooden Stand



3646/6

g	Icons	Part No.
730 g	25	3646/6

3646-115, 3646-125, 3646-150, 3646-165, 3646-180, 3646-200

Fine Grounded Pin Cylindrical Drift Punches with Octagonal Shank and Hand Protection



3646

Ø	L	Icons	Part No.
2 mm	115 mm	250	3646-115
3 mm	125 mm	250	3646-125
4 mm	150 mm	125	3646-150
5 mm	165 mm	125	3646-165
6 mm	180 mm	50	3646-180
8 mm	200 mm	50	3646-200

Cylindrical Drift Punches with Hexagonal Shank



3734N

Ø	L	Icons	Part No.
2 mm	150 mm	10	3734N-2-150
3 mm	150 mm	10	3734N-3-150
4 mm	150 mm	10	3734N-4-150
5 mm	150 mm	10	3734N-5-150
6 mm	150 mm	10	3734N-6-150
7 mm	150 mm	10	3734N-7-150

Chisel and Drift Punch Set - 6 Pcs/Plastic Wallet



3654R

g	Icons	Part No.
870 g	1	3654R

2 x 3656, 1 x 3649, 2 x 3644, 1 x 3643



Drift Punch Set with Knurled Guide Sleeve - 8 Pcs/Plastic Stand



3659/8

270 g	1	3659/8

3659-0.9, 3659-1.4, 3659-1.8, 3659-2.4, 3659-2.8, 3659-3.4, 3659-3.9, 3659-6.0

Cylindrical Drift Punch Set with Hand Protection - 6 Pcs/Wooden Stand



3658A/6

560 g	30	3658A/6

3658A-2, 3658A-3, 3658A-4, 3658A-5, 3658A-6, 3658A-8

Cylindrical Drift Punch Set with Hexagonal Shank - 9 Pcs/Wallet



3734NS/9

750 g	10	3734NS/9

3734N-10-150, 3734N-9-150, 3734N-8-150, 3734N-7-150, 3734N-6-150, 3734N-5-150, 3734N-4-150, 3734N-3-150, 3734N-2-150

Cylindrical Drift Punch Set with Octagonal Shank - 6 Pcs/Box



3734S/6

720 g	5	3734S/6

3734-2, 3734-3, 3734-4, 3734-5, 3734-6, 3734-8

Drift Punch Set with Knurled Guide Sleeve - 8 Pcs/Plastic Wallet



3659/8T

170 g	1	3659/8T

3659-0.9, 3659-2.8, 3659-2.4, 3659-1.8, 3659-6.0, 3659-3.9, 3659-3.4, 3659-1.4

Nail Drift Punches with Plastic Handle Retail Pack



3732

2 mm	125 mm	60	SB-3732-2-125
2.5 mm	125 mm	60	SB-3732-2.5-125
3.2 mm	125 mm	60	SB-3732-3.2-125
4 mm	125 mm	1	SB-3732-4-125

Chisel and Drift Punch Set - 10 Pcs/Plastic Wallet



3656/10

1260 g	1	3656/10

3 x 3656, 1 x 3644, 1 x 3649, 1 x 3643 en 3 x 3646

Conical Drift Punch Set with Octagonal Shank - 5 Pcs/Wallet



3733S/5

410 g	25	3733S/5

3733-4, 3733-2, 3733-6
3733-8, 3733-10

Wad Punch Noses



B400

2 mm	1	B400.002
3 mm	1	B400.003
4 mm	1	B400.004
5 mm	1	B400.005
6 mm	1	B400.006
7 mm	1	B400.007

		
8 mm	1	B400.008
9 mm	1	B400.009
10 mm	1	B400.010
11 mm	1	B400.011
12 mm	1	B400.012
13 mm	1	B400.013
14 mm	1	B400.014
15 mm	1	B400.015
16 mm	1	B400.016
17 mm	1	B400.017
18 mm	1	B400.018
19 mm	1	B400.019
20 mm	1	B400.020
21 mm	1	B400.021
22 mm	1	B400.022
23 mm	1	B400.023
24 mm	1	B400.024
25 mm	1	B400.025
26 mm	1	B400.026
27 mm	1	B400.027
28 mm	1	B400.028
29 mm	1	B400.029
30 mm	1	B400.030
31 mm	1	B400.031
32 mm	1	B400.032
33 mm	1	B400.033
34 mm	1	B400.034
35 mm	1	B400.035
36 mm	1	B400.036
37 mm	1	B400.037
38 mm	1	B400.038
39 mm	1	B400.039
40 mm	1	B400.040
41 mm	1	B400.041
42 mm	1	B400.042
43 mm	1	B400.043
44 mm	1	B400.044
45 mm	1	B400.045
46 mm	1	B400.046
47 mm	1	B400.047
48 mm	1	B400.048
49 mm	1	B400.049
50 mm	1	B400.050

Handles for 2 mm-30 mm Wad Punches



WPH3-30

		
185 mm	500 g	1 WPH 3-30

Interchangeable Wad Punch Set - 16 Pcs/ Plastic Case



400.003.030

	
3-30 mm	1 400.003.030

Handles for 2 mm-50 mm Wad Punches



WPH2-50

		
180 mm	761 g	1 WPH 2-50

Interchangeable Wad Punch Set - 32 Pcs/ Plastic Case



400.002.050

	
2-50 mm	1 400.002.050

Handles for 2 mm-20 mm Wad Punches



WPH3-20

		
95 mm	290 g	1 WPH 3-20

Interchangeable Wad Punch Set - 11 Pcs/ Plastic Case



400.003.020

	
3-20 mm	1 400.003.020

Revolving Wad Punches with Plastic Handle for 2 mm-4.5 mm



2635

	
245 mm	1 2635



Revolving Wad Punches for 2 mm-4.5 mm



4630



220 mm



1 4630

Knockout Screw Hole Punches



6900



16 mm
20 mm
22 mm
25 mm
30 mm
32 mm
35 mm
40 mm
50 mm
63 mm



1 690000160
1 690000200
1 690000220
1 690000250
1 690000300
1 690000320
1 690000350
1 690000400
1 690000500
1 690000630

Screw Punch Set - 7 Pcs/Plastic Box



6907



4080 g



1 69079019P

690000160, 690000250, 690000200, 690000320,
690000500, 690000400, 690000630

690900120, 690900080, 690900100, 690900200,
690900140

Spare Screws for 6900 Series Screw Punchers



6909



16 mm
20-25 mm
30-35 mm
40-50 mm
63 mm



4 690900080
4 690900100
2 690900120
2 690900140
1 690900200

PUNCHES WITH 2-COMPONENT HANDLE

Centre Punch with 2-Component Handle and Guard



SB3755BM



4 mm 165 mm 1 SB3755BM-4
6 mm 185 mm 5 SB3755BM-6

SB: Retail pack

Cylindrical Parallel Pin Punch with 2-Component Handle



SB3734BM



10 mm 180 mm 5 SB3734BM-10
3 mm 155 mm 5 SB3734BM-3
4 mm 165 mm 5 SB3734BM-4
5 mm 165 mm 5 SB3734BM-5
6 mm 185 mm 5 SB3734BM-6
8 mm 185 mm 5 SB3734BM-8

SB: Retail pack

Cylindrical Pin Punch Set with Dual-Component Handle - 7 Pcs/Plastic Tray



3734BMS/7



900 g



1 3734BMS/7

3734BM-2, 3734BM-3, 3734BM-4, 3734BM-5, 3734BM-6, 3734BM-8, 3734BM-10

COLD CHISELS WITH 2-COMPONENT HANDLE

Mason's Chisels with 2-component handle



SB3654BM



155 mm
185 mm



5 SB3654BM-15
5 SB3654BM-20

SB: Retail pack

Mixed Mason's Chisel Set with Dual-Component Handle - 7 Pcs/Plastic Tray



3654BMS/7



920 g



1 3654BMS/7

3734BM-2, 3734BM-4, 3734BM-5, 3734BM-6, 3654BM-15, 3654BM-20, 3755BM-6



Pry Bars



WRECKING BARS

Adjustable Pry Bars with V-Claw 260 mm



APB260

260 mm	410 g	10	APB260

Adjustable Pry Bars with V-Claw 360 mm



APB360

360 mm	543 g	10	APB360

Pry Bar Crowfoots with Precise End



CFP250

250 mm	6	CFP250

Premium Wrecking Bars with Bent and Flat End



WBP

14 mm	346 mm	20	WBP300
16 mm	487 mm	12	WBP500
17 mm	625 mm	12	WBP625
17 mm	704 mm	10	WBP710
20 mm	890 mm	6	WBP900

Wrecking Bars with Bent and Flat End



WBB

391 mm	14 mm	10	WBB400
500 mm	16 mm	10	WBB500
595 mm	18 mm	10	WBB600
680 mm	18 mm	6	WBB700
810 mm	18 mm	6	WBB800
1000 mm	20 mm	4	WBB1000
1200 mm	20 mm	4	WBB1200
1500 mm	22 mm	4	WBB1500

Flat Wrecking Bars with Bent and Flat End



WBF380

374 mm	35 mm	12	WBF380

Mini Flat Wrecking Bars with Bent and Flat End



WBMF190

18 mm	188 mm	24	WBMF190

Mini Flat Wrecking Bars with Bent and Flat End - 15 Pcs/Display



WBMF190IP

39 g	15	WBMF190IP

WBMF190x 15

Wrecking Bar Set - Flat, Mini & Premium with End 346 mm



WBP-3P-3FMF

1600 g	1	WBP-3P-3FMF

WBP300

WBF380

WBMF190

Wrecking Bar Set - Flat, Mini & Premium
with End 621 mm



WBP-3P-6FMF

3000 g	1	WBP-3P-6FMF

WBP625	
WBF380	
WBMF190	

Premium Wrecking Bar Set



WBP-3P-963

4740 g	1	WBP-3P-963

WBP900, WBP625, WBP300	
------------------------	--

Flat & Premium Wrecking Bar Set



WBP-3P-96F

6000 g	1	WBP-3P-96F

WBP900, WBP625	
WBF380	





BAHCO



Planting & Cultivating Tools



SMALL GARDEN TOOLS

Hoes with Dual-Component Handle



P262



315 mm



10 P262

One Point Hoes with Dual-Component Handle and Long Metal Rod



P278



455 mm



5 P278

Trowels with Dual-Component Handle



P263



370 mm



10 P263

Border Hoes with Dual-Component Handle



P272



450 mm



5 P272

Two Point Hoes with Dual-Component Handle



P267



320 mm



10 P267

Cultivators with Dual-Component Handle



P264



315 mm



10 P264

One Point Hoes with Dual-Component Handle



P268



320 mm



10 P268

Two Point Hoes with Dual-Component Handle and Long Metal Rod



P277



455 mm



5 P277

Border Cultivators with Dual-Component Handle



P274



470 mm



5 P274

Border Rakes with Dual-Component Handle



P276



450 mm



5 P276

Weeding Forks with Dual-Component Handle



P270



305 mm



10 P270

Rakes with Dual-Component Handle



P266



335 mm



10 P266

Bulb Planters with Solid Wooden Handle



P241



340 g



5 P241

Daisy Grubbers with Dual-Component Handle



P269



315 mm



10 P269



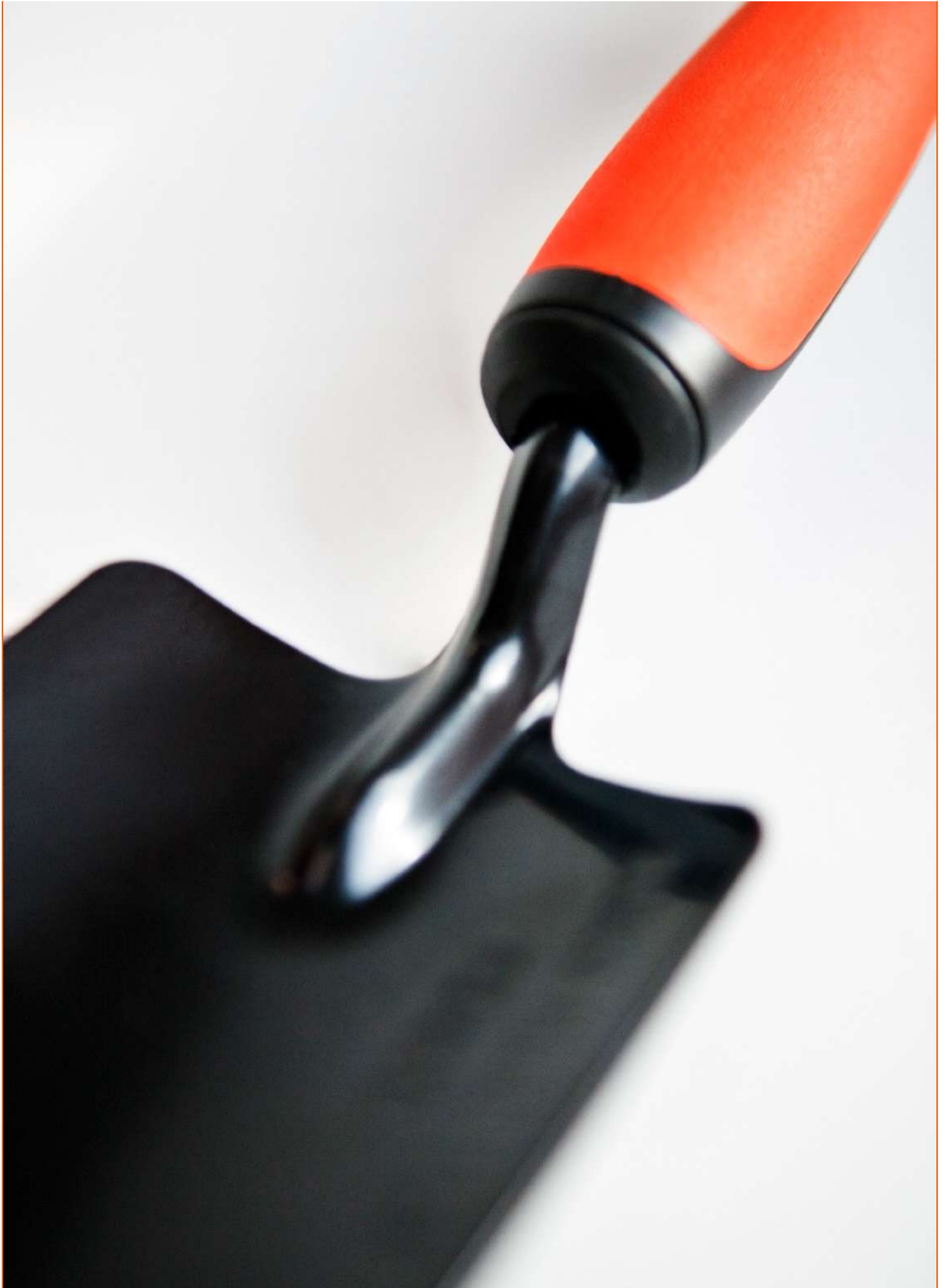

BAHCO



Pruning Tools



SECATEURS

ERGO™ Bypass Secateurs with Elastomer Coated Fixed Handle



PX

Icon	Icon
15 mm	2 PX-S1
20 mm	2 PX-S2
15 mm	2 PX-M1
20 mm	2 PX-M2
20 mm	2 PX-M2-L
30 mm	2 PX-M3
20 mm	2 PX-L2
30 mm	2 PX-L3

ERGO™ Bypass Secateurs with Elastomer Coated Rotating Handle



PXR

Icon	Icon
20 mm	2 PXR-S2-L
15 mm	2 PXR-S1
20 mm	2 PXR-S2
15 mm	2 PXR-M1
20 mm	2 PXR-M2
20 mm	2 PXR-M2-L
30 mm	2 PXR-M3
20 mm	2 PXR-L2

Spare Pre-assembled Cutting Heads for PX and PXR ERGO™ Bypass Secateurs



R801P-R804P

Icon	Icon
1	1 R801P
2	1 R802P
3	1 R803P
2	1 R804P

Spare Cutting Blades for ERGO™ Bypass Secateurs



R211P/R300P/R500P/R600P

Icon	Icon
Px/ Pxr N° 2, P1-20, P2-20	1 R211P
Px/ Pxr N° 2, P1-20, P2-20	80 R211P-BULK80
Px/ Pxr N° 1	1 R300P
Px/ Pxr N° 3	40 R500P
Px-M2-L & Pxr-M2-L	1 R600P

Spare Counter Blades for PX and PXR ERGO™ Bypass Secateurs



R303P-R603P

Icon	Icon
Px-S1, Px-M1, Px-L1, Pxr-M1, Pxr-L1	1 R303P
Px-S2, Px-M2, Px-L2, Pxr-M2, Pxr-L2	1 R403P
Px-S3, Px-M3, Px-L3, Pxr-M3, Pxr-L3	1 R503P
Px-M2-L, Pxr-M2-L	1 R603P

Spare Pair of Handles for PX and PXR ERGO™ Bypass Secateurs



R811P-RT825P

Icon	Icon
Px-S	1 R811P
Px-M	1 R812P
Px-L	1 R813P
Px-M2-L	1 R815P
PxR-S	1 RT821P
PxR-M	1 RT822P
PxR-L	6 RT823P
PxR-M2-L	1 RT824P
PXR-S2-L	6 RT825P

Spare Centre Bolts for ERGO™ Bypass Secateurs



R900P

Icon	g	Icon
PX & PXR	20 g	1 R900P

Spare Centre Bolt Locking Systems for ERGO™ Bypass Secateurs



R901P

Icon	g	Icon
PX & PXR	10 g	30 R901P

Spare Four Handle Screws with Inserts for PX and PXR ERGO™ Bypass Secateurs



R902P

PX & PXR	20 g	24	R902P

Spare Springs for P64 and ERGO™ Bypass Secateurs



R905P-R907P

PX & PXR, P64	10 g	1	R905P
PX & PXR, P64	164 g	50	R905P-BULK50
PX & PXR	10 g	1	R906P
PX & PXR	220 g	50	R906P-BULK50
PX & PXR	10 g	1	R907P

Bypass Secateurs with Composite Handle and Angled Head



P1

20 mm	200 mm	5	P1-20
30 mm	230 mm	5	P1-23

Spare Two Buffers for PX/PXR, P1/P2, P64 ERGO™ Bypass Secateurs



R903P/R1269P

PX & PXR, P1 & P2, P64	10 g	1	R903P
PX & PXR, P1 & P2, P64	486 g	50	R1269P-BULK50

Bypass Secateurs with Forged Steel Handle and Large Cutting Head



P3

20 mm	200 mm	2	P3-20-F
25 mm	230 mm	2	P3-23-F

Bypass Secateurs with Soft Grip Composite Handle and Narrow Cutting Head



P108

20 mm	200 mm	2	P108-20-F
25 mm	230 mm	2	P108-23-F

Spare Locking Devices for PX and PXR ERGO™ Bypass Secateurs



R904P

PX & PXR	10 g	1	R904P

Bypass Secateurs with Stamped/Pressed Steel Handle and Narrow Cutting Head



P110

20 mm	200 mm	2	P110-20-F
25 mm	230 mm	2	P110-23-F

Bypass Secateurs with Forged Steel Handle and Narrow Cutting Head



P5

25 mm	230 mm	2	P5-23-F



Anvil Secateurs with Stamped/Pressed Steel Handle



P138

Blade Width	Length (L)	Quantity	Part Number
20 mm	220 mm	6	P138-22-BULK6
20 mm	220 mm	6	P138-22-F

Cut and Hold Secateurs with Composite Handle



P64

Blade Width	Length (L)	Quantity	Part Number
12 mm	210 mm	12	P64-20-BULK12

Left and Right Handed Bypass Secateurs with Fibreglass Handle



PG-01-F/PG-03-L

Blade Width	Length (L)	Quantity	Part Number
12-20 mm	210 mm	6	PG-01-F
12-20 mm	210 mm	2	PG-03-L

Bypass Secateurs with Stamped/Pressed Steel Handle and Angled Cutting Head



P121

Blade Width	Length (L)	Quantity	Part Number
15 mm	180 mm	6	P121-18-F
20 mm	200 mm	6	P121-20-F
25 mm	230 mm	6	P121-23-F

Bypass Secateurs with Stamped/Pressed Steel Handle and Straight Cutting Head



P126

Blade Width	Length (L)	Quantity	Part Number
15 mm	190 mm	6	P126-19-F
20 mm	220 mm	6	P126-22-F

Left and Right Handed Bypass Secateurs with Composite Handle



PG-12-F

Blade Width	Length (L)	Quantity	Part Number
20 mm	210 mm	10	PG-12-F
20 mm	210 mm	15	PG-12-BULK15

Spare Anvils and Rivets



R221P/R222P

Part Number	Quantity	Part Number
P138-22	1	R221P
P138-22	50	R221P-BULK50

Spare Cutting Blades for P1-22, P2-22, P6 Bypass Pruners/P7 Left-Handed Pruners



R201P/R171P

Part Number	Quantity	Part Number
P1-22, P2-22	1	R201P
P1-22, P2-22	80	R201P-BULK80

Spare Cutting Blades for Hand and Top-Pruners



R112PG-R124PG/R224P

Part Number	Quantity	Part Number
P3-20, P5-20	1	R112PG
P108-20, P110-20	1	R114PG
P3-23, P5-23	30	R122PG
P108-23, P110-23, P34-27A	30	R124PG
P138-22	1	R223P
P138-22	80	R223P-BULK80

Spare Counter Blades for P1-22, P2-22 Bypass Pruners/P6 and P7 Left-Handed Pruners



R202P/R271P



P1-22, P2-22 1 R202P

Spare Centre Bolt/Nut/Washer Set for Pruners



R239P/R141P/R142P/R157H

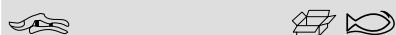

P34-27A, P3-20, P3-23, P5-20, P5-23, P108-20, P108-23, P110-20, P110-23 24 R142P
P121-23 1 R148V
P1-20, P1-22, P2-20, P2-22, P6-20, P7-20 1 R239P

Spare Counter Blades and Pins for Hand-Pruners



R113PG/R123PG

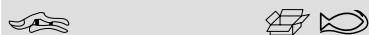

P108-20, P110-20 30 R113PG
P108-23, P110-23 30 R123PG

Spare Closing Springs



R341P/R474P

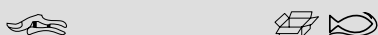

P3-20, P3-23 12 R341P
P5-20, P5-23, P108-20, P108-23, P110-20, P110-23 1 R474P

Spare Springs for One-Hand Pruners



R438P/R463P



P121-20 1 R434P
P121-20 50 R434P-BULK50
P121-23 1 R463P
P138-22 1 R438P
P138-22 50 R438P-BULK50

Spare Spring and Buffer Set for One-Hand Pruners



R1069P

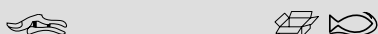

P1-20, P2-20, P6-20, P7-20 12 R1069P

Spare Springs, Buffers and Buffer Cup Set for One-Hand Pruners



R1068

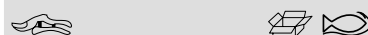

P3-20, P3-23, P5-20, P5-23, P108-20, P108-23, P110-20, P110-23 1 R1068

Spare Part Kit for P5-20 and P5-23 Re-Designed Secateurs



R1080P

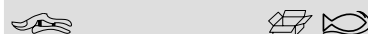

P5-20, P5-23 1 R1080P

Spare Handle Screws/Nuts/Closing Button Set with Flat Spring for Pruners



R1601



P1-20, P1-22, P2-20, P6-20, P7-20 1 R1601



Spare Locking Device with Screws and Nuts for P108 and P5 Bypass Secateurs



R478P/R480P

P108	1	R478P
P5	1	R480P

Straight Short Snips with Fibreglass Handle



P128

6 mm	6	P128-19
6 mm	30	P128-19-BULK30

LOPPERS

30 mm Professional Lightweight Bypass Loppers with Aluminium Handle



P114-SL

30 mm	400 mm	2	P114-SL-40
30 mm	500 mm	2	P114-SL-50
30 mm	600 mm	2	P114-SL-60

FRUIT PICKING TOOLS

Bypass Snips with Fibreglass Handle



P123

10 mm	30	P123-19-BULK30

11° Angled Snips with Fibreglass Handle



P129

6 mm	30	P129-19-BULK30

30 mm Professional Bypass Loppers with Steel Handle and Forged Counter Blade



P16

30 mm	400 mm	2	P16-40
30 mm	500 mm	2	P16-50-F
30 mm	600 mm	2	P16-60-F

Straight Long Snips with Fibreglass Handle



P127

6 mm	30	P127-19-BULK30

Spare Springs with Buffers for Snips



R1071/R1075

P123, P127, P128, P129	20 g	14	R1071
P123, P127, P128, P129	130 g	50	R1075-BULK50

30 mm Professional Bypass Loppers with Wooden Handle and Forged Counter Blade



P16-40W

30 mm	400 mm	2	P16-40W

35 mm Professional Lightweight Bypass Loppers with Aluminium Handle



P116-SL

Blade Width	Length (L)	Quantity	Part Number
35 mm	400 mm	2	P116-SL-40
35 mm	500 mm	2	P116-SL-50
35 mm	600 mm	2	P116-SL-60
35 mm	700 mm	2	P116-SL-70

45 mm Professional Lightweight Long Bypass Loppers with Aluminium Handle and Forged Counter Blade



P160-SL

Blade Width	Length (L)	Quantity	Part Number
45 mm	600 mm	2	P160-SL-60
45 mm	750 mm	1	P160-SL-75
45 mm	900 mm	1	P160-SL-90

50 mm Professional Bypass Loppers with Aluminium Handle



P19

Blade Width	Length (L)	Quantity	Part Number
50 mm	800 mm	1	P19-80-F

55 mm Professional Lightweight Long Bypass Loppers with Aluminium Handle



P280-SL

Blade Width	Length (L)	Quantity	Part Number
55 mm	600 mm	2	P280-SL-60
55 mm	800 mm	2	P280-SL-80

Professional Anvil Loppers with Lever Action and Aluminium Handle



P173-SL

Blade Width	Length (L)	Quantity	Part Number
45 mm	850 mm	1	P173-SL-85

35 mm Bypass Loppers with Steel Handle



P130-P140

Blade Width	Length (L)	Quantity	Part Number
40 mm	450 mm	6	P130-F
40 mm	660 mm	6	P140-F

40 mm Expert Bypass Loppers with Dual-Component Handle



PG-18

Blade Width	Length (L)	Quantity	Part Number
40 mm	450 mm	2	PG-18-45-F
40 mm	610 mm	2	PG-18-60-F

40 mm Expert Bypass Telescopic Loppers with Dual-Component Handle



PG-19

Blade Width	Length (L)	Quantity	Part Number
40 mm	700 - 900 mm	2	PG-19-F

Spare Cutting Blades for Loppers



R114V/R373A

Blade Width	Quantity	Part Number
P160-SL	28	R160A-BULK28
P280-SL-80	25	R185V
P14	25	R114V
P14	28	R114V-BULK28
P280	1	R181P
P-SL2, P116-SL	1	R16V
P-SL2, P116-SL	14	R16V-BULK14
P-SL, P114-SL	8	R115V
P-SL, P114-SL	14	R115V-BULK14
P16	1	R116V
P16	36	R116V-BULK36
P19-80	1	R119V
P160	1	R160A
P173-SL-85	25	R373A



Spare Counter Blades for Loppers



R214V/R26V/R260A/...

Icon	Icon	Icon
P14	1	R214V
P14	28	R214V-BULK28
P116-SL	8	R216SL
P-SL-40/45/60	1	R215V
P114-SL	1	R214SL
P160	16	R260A
P16*	40	R716VCB
P180-70	1	R680V
P19-80	1	R619V

Spare Buffers for Loppers and Hedge Shears



R430V-R516V

Icon	Icon	Icon
P-SL, P-SL2, P114, P116, P52-SL, P54-SL	22	R440V

Spare Anvils with Screws for Loppers



R372H

Icon	Icon	Icon
P172-65 /-85, P172-SL	1	R372H

Spare Central Bolt and Nut Set for Loppers



R312V-R318V/R143PV/R144PV/R146

Icon	Icon	Icon
P280-SL	12	R335V
P16	1	R143PV
P16*	1	R143PVCB
P160	24	R144PV
P14, P174, P176-75	24	R146VS
P14, P174, P176-75	50	R146VS-BULK50
P114-SL, P116-SL	22	R166V
P172-65 /-85	1	R312V
P-SL-40 /-45 /-60	1	R315V
P280-(SL)	22	R328V
P180-70, P19-80, P172	1	R318V

Spare Handle Bolt and Nut Set for Loppers



R415V-R775V

Icon	Icon	Icon
P280-SL	1	R775V
P173-SL-85	1	R776V
P-SL, P-SL2, P114, P116	1	R415V
P19-80	1	R519V
P14, P16	1	R615V
P160	24	R660V
P172-SL	14	R772V
P280-SL-80	1	R773V

Hexagonal Screws for Adjusting Blade to Anvil



R272H

Icon	Icon	Icon
P173-SL-85	30	R472H
P172-65/-85, P172-SL-85	1	R272H

POLE SAWS & TOP PRUNERS

Telescopic aluminium poles



ATP-200

Icon	Icon	Icon
2000-3520 mm	1	ATP-200-350
2070-5040 mm	1	ATP-200-500

Aluminium or Fibreglass Telescopic Poles



AP-/FP-

Icon	Icon	Icon
2000 - 5000 mm	1	AP-5M
2000 - 3500 mm	1	AP-3M
1800 - 3200 mm	1	FP-3M

Aluminium Compact Telescopic Poles



ATP-110-210

Icon	Icon	Icon
1100 - 2100 mm	1	ATP-110-210

Aluminium Base Section Poles



ASP-1850G



1870 mm



1 ASP-1850G



Adaptors for P34-37/P134/P34-27A-F Top Pruner



ASP-ATP



160 mm



100 g



6 ASP-ATP

Top Pruners with Triple Pulley Action



P34-37



40 mm



2 P34-37



Aluminium Extension Poles



ASP-1850



1870 mm



1 ASP-1850



Adaptor for section and telescopic poles



RAUNI



ATP-110-210



82 g



6 RAUNI

Top Pruners with Single Pulley Action



P34-27A



30 mm



2 P34-27A-F



Adaptors for Pole Saws



ASP-AS



135 mm



6 ASP-AS

Pole Hooks with Adaptor for ASP and ATP Poles



ASP-AS-HOOK



325 g



4 ASP-AS-HOOK



Top Pruners on Telescopic Pole



ATP-230-410



32 mm



2370 - 4110 mm



2 ATP-230-410



Top Pruners with Pull Cord



AP-234

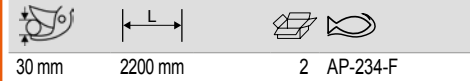

30 mm 2200 mm 2 AP-234-F

Spare Blade Kit for ATP-230-410 Telescopic Top Pruner



R230P

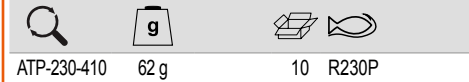

ATP-230-410 62 g 10 R230P

Spare Rubber Bumper & Inner Handle for Telescopic Top Pruner



RBCP230



ATP-230-410 66 g 12 RBCP230

Top Pruner Set



ASP3740-P

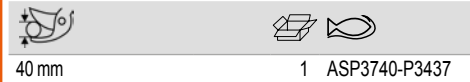

40 mm 1 ASP3740-P3437

ASP-1850G

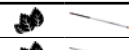

ASP-1850



P34-37



ASP-ATP



4750-PSTB-1



Spare Spring for ATP-230-410 Telescopic Top Pruner



R4230

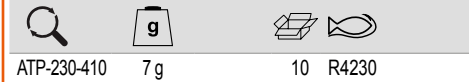

ATP-230-410 7 g 10 R4230

Spare Cam for ATP Telescopic Poles



RCAM

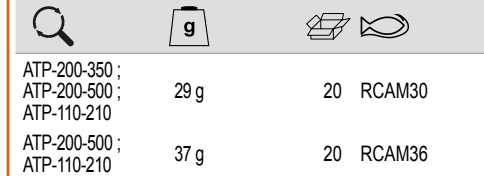

ATP-200-350 ;
ATP-200-500 ;
ATP-110-210 29 g 20 RCAM30

ATP-200-500 ;
ATP-110-210 37 g 20 RCAM36

Spare cutting blades for top-pruners P34-37



R137E



P34-37 30 R137E

Spare Rubber Bumper for Short Telescopic Pole



RBCP



ATP-110-210 30 g 10 RBCP

Spare Rope for Cutting Head



RD1M



ATP-230-410 5 g 15 RD1M

Spare Centre Bolt and Nut Set for P34-37 Top Pruners



R142P/R337E

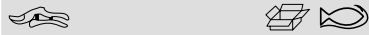

P34-37 1 R337E

Spare Lever for Cutting Head for ATP-230-410 Telescopic Top Pruner



RPL230G

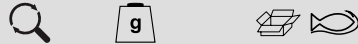

ATP-230-410 72 g 8 RPL230G

Medium Cut Pole Pruning Saws



ASP-AS-C_M

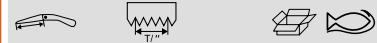

360 mm 6.2 5 ASP-AS-C36-JT-M

Spare Rope for Cutting Head for ATP-230-410 Telescopic Top Pruner



RD7M

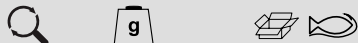

ATP-230-410 19 g 20 RD7M

Spare Springs for P34-27A Top Pruner



R427AE/R427E/R437E

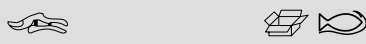

P134, P34-27A 18 R427AE
P34-37 18 R437E

Coarse Cut Pole Pruning Saws



ASP-AS-C_C

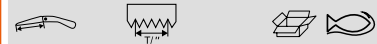

390 mm 5.4 5 ASP-AS-C39-JT-C
450 mm 5.4 2 ASP-AS-C45-JT-C

Spare Counter Blades for Top-Pruners



R133PG



P34-27A 1 R133PG

Fine Cut Pole Pruning Saws



ASP-AS-C_F

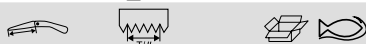

330 mm 7 5 ASP-AS-C33-JT-F

Hardpoint and Fileable Teeth Pole Pruning Saws with Plastic Handle



339-/340-



360 mm 6 4 339-6T
360 mm 6 4 340-6T



Hardpoint and Fileable Teeth Pole Pruning Saws with Steel Tube Handle



383-/384-

Length	Teeth	Quantity	Model
360 mm	6	4	383-6T
360 mm	6	4	384-6T
360 mm	5	4	384-5T

Pole Saws Set with 390 mm Coarse Cut Blade



ASP3740-C39JTC

Length	Weight	Quantity	Model
1950 mm	2838 g	1	ASP3740-C39JTC

ASP-1850G		
ASP-1850		
ASP-AS-C39-JT-C		
4750-PSTB-1		

Heavy Duty Lightweight Hedge Shears with Aluminium Handle



P51-SL

Length	Weight	Quantity	Model
570 mm	25 cm	2	P51-SL

Hardpoint and Fileable Teeth Pole Pruning Saws with Steel Tube Handle and Extended Hook Tip



385-/386-

Length	Teeth	Quantity	Model
360 mm	6	4	385-6T
360 mm	6	4	386-6T

Pole Saws Set with 450 mm Coarse Cut Blade



ASP3740-C45JTC

Length	Weight	Quantity	Model
1950 mm	2863 g	1	ASP3740-C45JTC

ASP-1850G		
ASP-1850		
ASP-AS-C45-JT-C		
4750-PSTB-1		

Heavy Duty Extra Long Lightweight Hedge Shears with Aluminium Handle



P51H-SL

Length	Weight	Quantity	Model
730 mm	25 cm	2	P51H-SL

Pole Saws Set with 360 mm Medium Cut Blade



ASP3740-C36JTM

Length	Weight	Quantity	Model
1950 mm	2819 g	1	ASP3740-C36JTM

ASP-1850G		
ASP-1850		
ASP-AS-C36-JT-M		
4750-PSTB-1		

HEDGE SHEARS

Heavy Duty Lightweight Hedge Shears with Steel Handle



P51

Length	Weight	Quantity	Model
570 mm	25 cm	2	P51-F

Heavy Duty Hedge Shears with Wooden Handle



P57-25

Length	Weight	Quantity	Model
540 mm	23 cm	4	P57-25-F

Lightweight Precision Hedge Shears with Aluminium Handle



P54-SL

550 mm	22.5 cm	2	P54-SL-25

Precision Hedge Shears with Aluminium Handle



PG-56

540 mm	23 cm	2	PG-56-F

Spare Buffers for Hedge Shears



R440V-R516V

P14, P16, P180-70, P19-80, P160-60, P51	22	R515VS
P160, P160-SL, P280-SL	22	R516V
P53-SL, P54H-SL, P52-SL-20	22	R444V

Long Lightweight Precision Hedge Shears with Aluminium Handle



P54H-SL

650 mm	22.5 cm	2	P54H-SL-25

Expert Telescopic Hedge Shears with Aluminium Handle



PG-57-F

800-1050 mm	20 cm	2	PG-57-F

Centre Bolt/Nut/Locking Ring Set for Hedge Shears



R146VC/R147V

P51, P51H, P52, P53, P54, P52-SL-20	22	R146VC
P55, P57	24	R147V

Lightweight Extra Precision Hedge Shears with Aluminium Handle



P52-SL-20

590 mm	18 cm	2	P52-SL-20

Universal Hedge Shears with Steel Handle



P59

580 mm	21 cm	6	P59-25-F

GRASS SHEARS

3-Positions Grass Shears with Plastic Sleeve Handle



GS-76

355 mm	435 g	8	GS-76



Multi-Angle Grass Shear



GS-180

375 mm	317 g	6	GS-180-F

Duck's Foot Grass Shears with Plastic Sleeve Handle 1100 mm



P74

1100 mm	2000 g	1	P74

Grass Shears with Plastic Sleeve Handle 1000 mm



P75

1000 mm	1900 g	1	P75

PRUNING KNIVES

Foldable Grafting Knives with Plastic Handle



P11

180 mm	70 g	6	P11

Foldable Pruning Knives with Plastic Handle



P20

190 mm	100 g	6	P20

Bow-Shaped Foldable Pruning Knives with Stainless Steel Handle



K-AP-1

90 g	10	K-AP-1

Hook-Shaped Foldable Pruning Knives with Stainless Steel Handle



K-GP-1

90 g	10	K-GP-1

SCISSORS

Floral Scissor with Soft Touch Finger Loop - Small



FS-5

10	FS-5

Floral Scissor with Soft Touch Finger Loop - Medium



FS-8

10	FS-8

Floral Scissor with Soft Touch Finger Loop - Large



FS-7.5



10 FS-7.5

BOW SAWS

ERGO™ Heavy Duty Professional Bow Saws 21"-30"



ergo



10



530 mm	21 in	5	10-21-51
607 mm	24 in	5	10-24-23
607 mm	24 in	5	10-24-51
759 mm	30 in	5	10-30-23
759 mm	30 in	5	10-30-51

ERGO™ Pointed Heavy Duty Professional Bow Saws 21"



ergo



332



530 mm	21 in	5	332-21-51
--------	-------	---	-----------

General Purpose Bow Saws 21" to 36"



SE -15-16



530 mm	21 in	5	SE-16-21
530 mm	21 in	5	SE-16-21-23
607 mm	24 in	5	SE-15-24
759 mm	30 in	5	SE-15-30
759 mm	30 in	5	SE-15-30-23
810 mm	32 in	5	SE-15-32
912 mm	36 in	5	SE-15-36
912 mm	36 in	5	SE-15-36-23

General Purpose Bow Saws with Reversible Blade 24"



3-24-51



607 mm	24 in	5	3-24-51
--------	-------	---	---------

General Purpose Bow Saws with Reversible Blade 21"



2-21-51



530 mm	21 in	5	2-21-51
--------	-------	---	---------

Pointed Bow Saws for Dry Wood 21"



331-21



530 mm	21 in	5	331-21-51-KP
--------	-------	---	--------------

General Purpose Bow Saws with Reversible Blade 14"



333



350 mm	14 in	5	333
--------	-------	---	-----

Pointed Bow Saws for Green Wood 15"



331-15



378 mm	15 in	5	331-15-23
--------	-------	---	-----------



Bow Saws for Ventilation Tubes 24"



14-24

607 mm	24 in	5	14-24-3810

Green Wood Spare Blades for Bow Saw 15"-36"



23

378 mm	13.33 in	10	23-15
530 mm	20.75 in	10	23-21
607 mm	24 in	10	23-24
759 mm	30 in	10	23-30
810 mm	28.57 in	10	23-32
912 mm	36 in	10	23-36

Foldable Pruning Saws with Low Friction Blade



PG-72

190 mm	7	4	PG-72

Toolbox-Sized Mini Bow Saw 12"



9-12

320 mm	12 in	5	9-12-51/3806-KP

Fine Peg Toothed Spare Blades for Bow Saw 14"



333-5

350 mm	13-3/4 in	10	333-5

Foldable Pruning Saws with Dual-Component Handle for Dry Wood/Plastic/Bone Cutting



396-LAP

190 mm	200 g	10	396-LAP
190 mm	44 g	100	396-BLADE
190 mm	44 g	1	396-BLADE-1P

Dry Wood Spare Blades for Bow Saw 12"-36"



51

320 mm	12-1/2 in	10	51-12
530 mm	20.75 in	10	51-21
607 mm	24 in	10	51-24
759 mm	30 in	10	51-30
810 mm	28.57 in	10	51-32
912 mm	36 in	10	51-36

PRUNING SAWS

Toothed Handheld Pruning Saws with Low Friction Blade



349

300 mm	7	4	349

Foldable Pruning Saws with Dual-Component Handle for Green Branches Cutting



396-JS

190 mm	5	4	396-JS

Foldable Pruning Saws with Dual-Component Handle for Winter Pruning



396-JT



190 mm	7	4	396-JT

Handheld Pruning Saws with Dual-Component Handle and Holster for Green Branches Cutting



51-JS



240 mm	5	4	5124-JS-H
280 mm	5	4	5128-JS-H

Spare Blades for 51-JS Pruning Saws



5724-JS/5728-JS

240 mm	5	1	5724-JS
280 mm	5	1	5728-JS

Foldable Pruning Saws with Dual-Component Handle for Hard/Dry Wood Cutting



396-HP



190 mm	7	4	396-HP

Pruning Saws with Dual-Component Handle and Holster for Winter Pruning



41-JT



240 mm	7	4	4124-JT-H
280 mm	7	4	4128-JT-H

Spare Blades for 41-JT Pruning Saws



4724-JT/4728-JT

240 mm	7	1	4724-JT
280 mm	7	1	4728-JT

4211 Hardpoint and 4212 Fileable Toothed Pruning Saws with Wooden Handle



4211-4212-



280 mm	6	4	4211-11-6T
360 mm	6	4	4211-14-6T
280 mm	6	4	4212-11-6T
360 mm	6	4	4212-14-6T

Foldable Saw and Knife Laplander Set with Dual-Component Handle



LAP-KNIFE



329 g	10	LAP-KNIFE

396-LAP
2444-LAP



Spare Blades for 396-JS Pruning Saws



396-JS-BLADE

190 mm	5	300	396-JS-BLADE



Spare Blades for 396-JT Pruning Saws



396-JT-BLADE

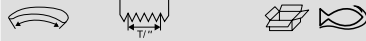

190 mm 7 300 396-JT-BLADE

Spare Blades for 396-HP Pruning Saws



396-HP-BLADE



190 mm 7 300 396-HP-BLADE

Spare Blades for 4211/4212/339/340 Pruning Saws



4400-/4420-



280 mm	6	10	4400-11
360 mm	6	10	4400-14
280 mm	6	10	4420-11
360 mm	6	10	4420-14
280 mm	6	10	4400-11-BULK
360 mm	6	10	4400-14-BULK
280 mm	6	10	4420-11-BULK
360 mm	6	10	4420-14-BULK

SPARE PARTS & ACCESSORIES

Spare Fine Cut Curved Blades for Pole Saws



AS-F-BLADE



330 mm 7 15 AS-C33-JT-F

Spare Medium Cut Curved Blades for Pole Saws



AS-M-BLADE

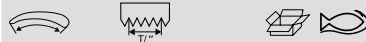

360 mm 6.2 15 AS-C36-JT-M

Spare Coarse Cut Curved Blades for Pole Saws



AS-C-C-BLADE



390 mm 5.4 15 AS-C39-JT-C
450 mm 5.4 15 AS-C45-JT-C

ACCESSORIES & MAINTENANCE

Synthetic Grinding Stones 180/400 Grain



LS-COMBINESS

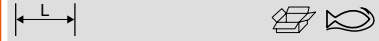

100 mm 1 LS-COMBINESS

Synthetic Grinding Stones 320 Grain



LS-CORINDON

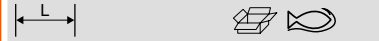

100 mm 1 LS-PIERRE CORINDON

Grinding Stones and Carbide Sharpener with Dual-Component Handle



SHARP-X

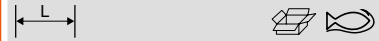

100 mm 10 SHARP-X
100 mm 1 SHARP-X-DISP

Synthetic Grinding Stones 180 Grain



LS-PIERRE-FAUX



230 mm



1 LS-PIERRE-FAUX

Carbor Type Synthetic Grinding Stones
220 Grain



LS-6160-23



230 mm



1 LS-6160-23

Lubricants 50 ml Spray Bottle



LUB-2015



60 g



6 LUB-2015





BAHCO



Air Tools Outdoor



SECATEURS

Professional Air Secateurs with Single Cutting Blade



9210



30 mm 1 9210

Cutting Blades and Rivets for 9210 Air Secateurs



9210-1



9210 82 g 1 9210-1

Complete Pre-Assembled Cutting Heads for 9210 Air Secateurs



9210-10



9210 212 g 1 9210-10

Pack of Assorted O-Rings for 9210 Air Secateurs



9210-20



9210 28 g 1 9210-20

Brass Sleeves for 9210 Air Secateurs - 10 Pcs



9210-1720100



9210 55.3 g 1 9210-1720100

Piston Discs for 9210 Air Secateurs



9210-1690148



9210 22 g 1 9210-1690148

Shock Absorbers for 9210 Air Secateurs



9210-1730107



9210 176 g 10 9210-1730107

Piston Seals for 9210 Air Secateurs



9210-1230235



9210 6.7 g 1 9210-1230235

Return Springs for 9210 Air Secateurs



9210-1640142



9210 26.6 g 1 9210-1640142

Connecting Rods for 9210 Air Secateurs



9210-1700118



9210 41 g 1 9210-1700118

TSP 2.2 mm x 6.5 mm Self Tapping Screws for 9210 Air Secateurs



9210-1060238

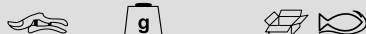

9210 10 g 20 9210-1060238

TCCE M6 x 20 mm Screws for 9210 Air Secateurs



9210-1060177



9210 7 g 1 9210-1060177

Special Rivets for 9210 Air Secateurs



9210-1770106

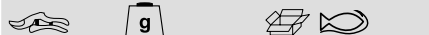

9210 1000 g 10 9210-1770106

Front Covers for 9210 Air Secateurs



9210-1830137

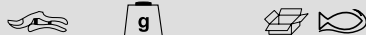

9210 9.5 g 1 9210-1830137

Hand Guards for 9210 Air Secateurs



9210-1320281



9210 35 g 10 9210-1320281

Dust Protection Seals for 9210 Air Secateurs



9210-1230219

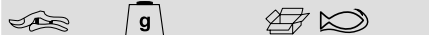

9210 8.6 g 20 9210-1230219

Secateurs Body with Brass Cylinder for 9210 Air Secateurs



9210-1710266

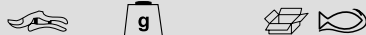

9210 193 g 1 9210-1710266





BAHCO



Lindström

PRECISION CUTTERS

DIAGONAL CUTTERS

ERGO™ Precision Diagonal Cutters with Oval Head



ergo®



RX 8130-RX 8162

Capacity	Head Type	Quantity	Part No.
0.00-0.04 / 0.2-1.0	Micro-Bevel®	10	RX 8130
0.00-0.04 / 0.1-1.0	Flush	10	RX 8131
0.00-0.03 / 0.1-0.8	Ultra-Flush®	10	RX 8132
0.00-0.05 / 0.2-1.25	Micro-Bevel®	10	RX 8140
0.00-0.05 / 0.1-1.25	Flush	10	RX 8141
0.00-0.04 / 0.1-1.0	Ultra-Flush®	10	RX 8142
0.01-0.06 / 0.3-1.6	Micro-Bevel®	10	RX 8150
0.00-0.06 / 0.2-1.6	Flush	10	RX 8151
0.00-0.05 / 0.2-1.25	Ultra-Flush®	10	RX 8152
0.02-0.08 / 0.4-2.0	Micro-Bevel®	10	RX 8160
0.01-0.08 / 0.3-2.0	Flush	10	RX 8161
0.01-0.06 / 0.3-1.6	Ultra-Flush®	10	RX 8162

Precision Diagonal Cutters with Oval Head & ESD Safe Handle



8130-8162

Capacity	Head Type	Quantity	Part No.
0.01-0.04 / 0.2-1.0	Micro-Bevel®	10	8130
0.00-0.04 / 0.1-1.0	Flush	10	8131
0.00-0.03 / 0.1-0.8	Ultra-Flush®	10	8132
0.01-0.05 / 0.2-1.25	Micro-Bevel®	10	8140
0.00-0.05 / 0.1-1.25	Flush	10	8141
0.00-0.04 / 0.1-1.0	Ultra-Flush®	10	8142
0.01-0.06 / 0.3-1.6	Micro-Bevel®	10	8150
0.01-0.06 / 0.2-1.6	Flush	10	8151
0.00-0.05 / 0.1-1.25	Ultra-Flush®	10	8152
0.02-0.08 / 0.4-2.0	Micro-Bevel®	10	8160
0.01-0.08 / 0.3-2.0	Flush	10	8161
0.01-0.06 / 0.3-1.6	Ultra-Flush®	10	8162
0.00-0.04 / 0.1-1.0	Flush	10	8131 CO
0.01-0.05 / 0.2-1.25	Micro-Bevel®	10	8140 CO
0.00-0.05 / 0.1-1.25	Flush	10	8141 CO
0.00-0.04 / 0.1-1.0	Ultra-Flush®	10	8142 CO
0.01-0.06 / 0.3-1.6	Micro-Bevel®	10	8150 CO
0.01-0.06 / 0.2-1.6	Flush	10	8151 CO
0.02-0.08 / 0.4-2.0	Micro-Bevel®	10	8160 CO
0.01-0.08 / 0.3-2.0	Flush	10	8161 CO

Long Precision Diagonal Cutters with Oval Head & ESD Safe Handle



HS 8130-HS 8162

Capacity	Head Type	Quantity	Part No.
0.2-1.25 mm	Micro-Bevel®	1	HS 8130
0.1-1.25 mm	Flush	1	HS 8131
0.1-1.0 mm	Ultra-Flush®	1	HS 8132
0.2-1.25 mm	Micro-Bevel®	10	HS 8140
0.1-1.25 mm	Flush	10	HS 8141
0.1-1.0 mm	Ultra-Flush®	10	HS 8142
0.3-1.6 mm	Micro-Bevel®	1	HS 8150
0.2-1.6 mm	Flush	10	HS8151
0.1-1.25 mm	Ultra-Flush®	10	HS8152
0.4-2.0 mm	Micro-Bevel®	10	HS 8160
0.3-2.0 mm	Flush	10	HS 8161
0.3-2.0 mm	Ultra-Flush®	10	HS 8162

ERGO™ Precision Diagonal Cutters with Tapered Head



ergo®



RX 8133-RX 8165

Capacity	Head Type	Quantity	Part No.
0.008-0.04 / 0.2-1.0	Micro-Bevel®	10	RX8133
0.004-0.03 / 0.1-0.8	Flush	10	RX8134
0.004-0.02 / 0.1-0.5	Ultra-Flush®	10	RX8135
0.01-0.05 / 0.2-1.25	Micro-Bevel®	10	RX 8143
0.00-0.05 / 0.1-1.25	Flush	10	RX 8144
0.00-0.04 / 0.1-1.0	Ultra-Flush®	10	RX 8145
0.01-0.06 / 0.3-1.6	Micro-Bevel®	10	RX 8153
0.01-0.06 / 0.2-1.6	Flush	10	RX 8154
0.01-0.05 / 0.2-1.25	Ultra-Flush®	10	RX8155
0.02-0.08 / 0.4-2.0	Micro-Bevel®	10	RX8163
0.01-0.08 / 0.3-2.0	Flush	10	RX 8164
0.01-0.06 / 0.3-1.6	Ultra-Flush®	10	RX 8165

Precision Diagonal Cutters with Tapered Head



8133-8165

Capacity	Head Type	Quantity	Part No.
0.008-0.04 / 0.2-1.0	Micro-Bevel®	10	8133
0.004-0.03 / 0.1-0.8	Flush	10	8134
0.004-0.02 / 0.1-0.5	Ultra-Flush®	10	8135
0.01-0.05 / 0.2-1.25	Micro-Bevel®	10	8143
0.01-0.05 / 0.2-1.25	Flush	10	8144
0.00-0.04 / 0.1-1.0	Ultra-Flush®	10	8145
0.01-0.06 / 0.3-1.6	Micro-Bevel®	10	8153
0.01-0.06 / 0.2-1.6	Flush	10	8154
0.01-0.05 / 0.2-1.25	Ultra-Flush®	10	8155
0.02-0.08 / 0.4-2.0	Micro-Bevel®	10	8163
0.01-0.08 / 0.3-2.0	Flush	10	8164
0.01-0.06 / 0.3-1.6	Ultra-Flush®	10	8165
0.01-0.05 / 0.2-1.25	Flush	10	8144 CO
0.01-0.06 / 0.2-1.6	Flush	10	8154 CO
0.02-0.08 / 0.4-2.0	Micro-Bevel®	10	8163 CO
0.01-0.06 / 0.3-1.6	Ultra-Flush®	10	8165 CO

Diagonal Cutters with Tapered Head & ESD Safe Handle



7190-7191

Capacity	Head Type	Quantity	Part No.
0.00-0.04 / 0.2-1.0	Micro-Bevel®	10	7190
0.00-0.04 / 0.1-1.0	Flush	10	7191
0.00-0.04 / 0.2-1.0	Micro-Bevel®	10	7190 CO
0.00-0.04 / 0.1-1.0	Flush	10	7191 CO

Long Precision Diagonal Cutters with Tapered Head & ESD Safe Handle



HS 8133-HS 8165

Head Type	Handle Type	Quantity	Model
Micro-Bevel®	ESD Safe	1	HS8133
Flush	ESD Safe	1	HS8134
Ultra-Flush®	ESD Safe	1	HS8135
Micro-Bevel®	ESD Safe	10	HS 8143
Flush	ESD Safe	10	HS 8144
Ultra-Flush®	ESD Safe	10	HS 8145
Micro-Bevel®	ESD Safe	10	HS8153
Flush	ESD Safe	10	HS8154
Ultra-Flush®	ESD Safe	1	HS8155
Micro-Bevel®	ESD Safe	10	HS 8163
Flush	ESD Safe	10	HS 8164
Ultra-Flush®	ESD Safe	10	HS8165

Long Diagonal Cutters with Tapered Head & ESD Safe Handle



HS 7190-HS 7191

Head Type	Handle Type	Quantity	Model
Micro-Bevel®	ESD Safe	1	HS7190
Flush	ESD Safe	1	HS7191

ERGO™ Precision Diagonal Cutters with Tapered & Relieved Head



RX 8136-RX 8168

Head Type	Handle Type	Quantity	Model
Micro-Bevel®	ESD Safe	10	RX8136
Flush	ESD Safe	10	RX 8137
Ultra-Flush®	ESD Safe	10	RX8138
Micro-Bevel®	ESD Safe	10	RX 8146
Flush	ESD Safe	10	RX 8147

Precision Diagonal Cutters with Tapered Head & Relieved & ESD Safe Handle



8136-8168

Head Type	Handle Type	Quantity	Model
Micro-Bevel®	ESD Safe	10	8136
Flush	ESD Safe	10	8137
Ultra-Flush®	ESD Safe	10	8138
Micro-Bevel®	ESD Safe	10	8146
Flush	ESD Safe	10	8147
Ultra-Flush®	ESD Safe	10	8148
Micro-Bevel®	ESD Safe	10	8156
Flush	ESD Safe	10	8157
Ultra-Flush®	ESD Safe	10	8158
Micro-Bevel®	ESD Safe	10	8166L
Flush	ESD Safe	10	8167L
Ultra-Flush®	ESD Safe	10	8168L
Ultra-Flush®	ESD Safe	10	8148 CO

Long Precision Diagonal Cutters with Tapered & Relieved Head & ESD Safe Handle



HS 8136-HS 8168

Head Type	Handle Type	Quantity	Model
Micro-Bevel®	ESD Safe	1	HS8136
Flush	ESD Safe	1	HS8137
Ultra-Flush®	ESD Safe	1	HS8138
Micro-Bevel®	ESD Safe	10	HS8146
Flush	ESD Safe	10	HS8147

Head Type	Handle Type	Quantity	Model
Ultra-Flush®	ESD Safe	10	HS 8148
Micro-Bevel®	ESD Safe	1	HS8156
Flush	ESD Safe	1	HS8157
Ultra-Flush®	ESD Safe	1	HS8158
Micro-Bevel®	ESD Safe	1	HS8166
Flush	ESD Safe	1	HS8167
Ultra-Flush®	ESD Safe	1	HS8168

DIAGONAL CUTTERS, UNIQUE HEAD

ERGO™ Precision Diagonal Cutters with Tapered & Relieved Head



RX8137MX-RX8138MX

Head Type	Handle Type	Quantity	Model
Flush	ESD Safe	10	RX8137MX
Ultra-Flush®	ESD Safe	10	RX8138MX

OBLIQUE - END CUTTERS

Precision 11° Oblique End Cutters 0.35 mm-1.25 mm



7290-7291

Head Type	Handle Type	Quantity	Model
Micro-Bevel®	ESD Safe	10	7290
Flush	ESD Safe	10	7291

Long Precision 11° Angled Oblique End Cutters 0.35 mm-1.25 mm



HS 7290-HS 7291

0.01-0.03 / 0.35-0.8	Micro-Bevel®	1	HS7290
0.01-0.03 / 0.35-0.8	Flush	1	HS7291

Precision Oblique End Cutters with Miniature Head



7292

0.01-0.03 / 0.35	Flush	10	7292

Long Precision Oblique End Cutters with Miniature Head



HS 7292

0.01-0.03 / 0.35-0.8	Flush	10	HS7292

Precision 11° Angled Oblique End Cutters 0.35 mm-1 mm



7293

0.01-0.03 / 0.35-0.8	Flush	10	7293

Long Precision 11° Angled Oblique End Cutters 0.35 mm-1 mm



HS 7293

0.01-0.04 / 0.35-1.0	Flush	1	HS7293

Long Precision 20° Short Head Oblique Cutters 0.2 mm-1.2 mm



HS 8211

0.01-0.05 / 0.2-1.2	Flush	10	HS8211

ANGLE

ERGO™ Short Precision 20° Head Oblique Cutters 0.2 mm-1.2 mm



RX 8211

0.01-0.05 / 0.2-1.2	Flush	10	RX 8211

ERGO™ Long Precision 45° Tapered Head Oblique Cutters 0.2 mm-1 mm



RX 8247

0.01-0.04 / 0.2-1.0	Flush	10	RX 8247

Short Precision 20° Head Oblique Cutters 0.2 mm-1.2 mm



8211

0.01-0.05 / 0.2-1.2	Flush	10	8211

Precision 45° Head Oblique Cutters 0.2 mm-1 mm



8247

0.01-0.04 / 0.2-1.0	Flush	10	8247
0.01-0.04 / 0.2-1.0	Flush	10	8247 CO

Long Precision 45° Tapered Head Oblique Cutters 0.2 mm-1 mm



HS 8247



0.01-0.04 / 0.2-1.0 Flush 1 HS 8247

ERGO™ Long Precision 45° Tapered & Relieved Head Oblique Cutters 0.2 mm-0.8 mm



ergo



RX 8248



0.01-0.03 / 0.2-0.8 Flush 10 RX 8248

Precision 45° Oblique Cutters 0.2 mm-1 mm



7285

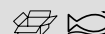

0.2-1.0 mm Flush 10 7285

Long Precision 45° Tapered & Relieved Head Oblique Cutters 0.2 mm-0.8 mm



HS 8248



0.01-0.03 / 0.2-0.8 Flush 10 HS 8248

Precision 45° Oblique Cutters 0.2 mm-0.8 mm



7280



0.01-0.03 / 0.2-0.8 Flush 10 7280

Long Precision 45° Oblique Cutters 0.2 mm-1 mm



HS 7285



0.01-0.04 / 0.2-1.0 Flush 1 HS7285

Long Precision 45° Tapered & Relieved Head Oblique Cutters 0.2 mm-0.8 mm



8248



0.01-0.03 / 0.2-0.8 Flush 10 8248
0.00-0.03 / 0.2-0.8 Flush 10 8249
0.01-0.03 / 0.2-0.8 Flush 10 8248 CO

Long Precision Reverse Oblique Cutters 0.2 mm-0.8 mm



HS 7280

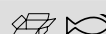

0.01-0.03 / 0.2-0.8 Flush 1 HS7280

PLASTIC CUTTERS

ERGO™ Precision Diagonal Plastic Cutters



ergo



P6160

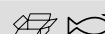

1.5 mm Flush 10 P6160

TIP CUTTER

ERGO™ Precision Diagonal Tip Cutters



ergo



RX 8149

0.01-0.02 / 0.1-0.6	Flush	10	RX 8149

Precision Diagonal Tip Cutters with ESD Safe Handle



8149

0.00-0.02 / 0.1-0.6	Flush	10	8149

Long Precision Diagonal Tip Cutters with ESD Safe Handle



HS 8149

0.01-0.02 / 0.1-0.6	Flush	1	HS8149

OBLIQUE CUTTERS, UNIQUE HEAD

Long Precision 45° Tapered & Relieved Head Oblique Cutters 0.2 mm-0.8 mm



8248Q

0.00-0.03 / 0.2-0.8	Ultra-Flush®	10	8248Q

Precision Oblique End Cutters with Miniature Head



7292G

0.01-0.03 / 0.35	Flush	10	7292G

MICRO TIP CUTTERS

ERGO™ Precision Micro Tip Cutters 149 mm



ergo



RX 8233

0.004-0.024 / 0.1-0.6	Flush	10	RX8233A

ERGO™ Precision Micro Tip Cutters 141 mm



ergo



RX 8234

0.002-0.018 / 0.05-0.4	Flush	10	RX8234A

ERGO™ Precision Micro Tip Cutters 144 mm



ergo



RX 8237

0.004-0.02 / 0.1-0.5	Flush	10	RX8237A

MULTIPURPOSE SHEARS

Multipurpose Shear with Non-Slip Grips



HS6000

Kevlar	Flush	10	HS6000
Kevlar	Flush	10	HS6001

ACCESSORIES & SPARE PARTS

Lead Catchers for 8130 & 8140 Series Diagonal Cutters



813/814/816

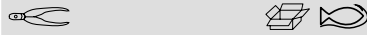

8130-8132, Rx 8130-8132	1	813
8140-8148, Rx 8140-8148	1	814
8130-8132, 8140-8148	1	816

Return Springs for RX Series



RX 01



5g	1	RX 01
----	---	-------

Return Springs for 80, Supreme and HS Series



8130-50/8160

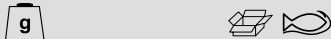

1g	1	8130-50/SUPR SPRING
1g	1	8160/SPRING

PRECISION CUTTERS FOR HARD MATERIALS

CARBIDE CUTTERS

Precision Carbide Diagonal Cutters with Tapered Head for Hard Materials



7154 TC



0.1-0.9 mm	0.1-0.4 mm	10	7154TC
------------	------------	----	--------

PERFORMANCE SPECIFIC DIAGONAL CUTTERS

ERGO™ Precision Performance Specific Diagonal Cutters with Oval Head



ergo



RX 8140PS-RX 8161PS



0.01-0.04 / 0.1-1.0	Micro-Bevel®	10	RX8140PS
0.01-0.04 / 0.1-1.0	Flush	10	RX8141PS
0.01-0.04 / 0.1-1.0	Micro-Bevel®	10	RX 8142PS
0.01-0.04 / 0.1-1.0	Micro-Bevel®	10	RX8150PS
0.01-0.06 / 0.3-1.6	Flush	10	RX 8161PS

EXTRA HARDENED DIAGONAL CUTTERS

ERGO™ Precision Extra Hardened Diagonal Cutters with Oval Head



ergo



RX 8140M2-8160M2



0.01-0.05 / 0.4-2.0	Micro-Bevel®	10	RX8140M2
0.01-0.06 / 0.4-2.0	Micro-Bevel®	10	RX8150M2
0.02-0.08 / 0.4-2.0	Micro-Bevel®	10	RX8160M2

Precision Performance Specific Diagonal Cutters with Oval Head & ESD Safe Handle for hard materials



8140PS-8161PS



0.01-0.04 / 0.1-1.0	Micro-Bevel®	10	8140PS
0.01-0.04 / 0.1-1.0	Flush	10	8141PS
0.00-0.05 / 0.1-1.25	Micro-Bevel®	10	8150PS
0.01-0.06 / 0.3-1.6	Micro-Bevel®	10	8160PS
0.01-0.06 / 0.3-1.6	Flush	10	8161PS

Precision Extra Hardened Diagonal Cutters with Oval Head & ESD Safe Handle for hard materials



8140M2-8160M2



0.01-0.05 / 0.4-2.0	Micro-Bevel®	10	8140M2
0.01-0.06 / 0.4-2.0	Micro-Bevel®	10	8150M2
0.02-0.08 / 0.4-2.0	Micro-Bevel®	10	8160 M2

ERGO™ Precision Diagonal Cutters with Tapered Head & ESD Safe Handle for hard materials



ergo



RX8143PS-RX 8147PS



0.01-0.04 / 0.1-1.0	Flush	10	RX8143PS
0.004-0.03 / 0.1-0.8	Flush	10	RX 8147PS

PERFORMANCE SPECIFIC DIAGONAL CUTTERS, UNIQUE HEAD

ERGO™ Precision Performance Specific Diagonal Cutters with Oval Head



RX8140PSF-RX8160BPS

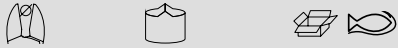

0.01-0.04 / 0.1-1.0 Micro-Bevel® 10 RX8160BPS

Precision Performance Specific Diagonal Cutters with Oval Head



8154PSP

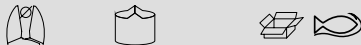

0.00-0.05 in Micro-Bevel® 10 8154PSP

PRECISION HOLDING PLIERS

FLAT NOSE

Flat Nose Pliers with Dual-Component Synthetic Handle



7490

20 mm	S	10	7490
20 mm	S	10	7490 CO

ERGO™ Precision Flat Nose Pliers with Dual-Component Synthetic Handle



RX 7490

20 mm	S	10	RX 7490

Long Flat Nose Pliers with Dual-Component Synthetic Handle



HS 7490

S	10	HS7490

ROUND NOSE

ERGO™ Precision Round Nose Pliers with Dual-Component Synthetic Handle



RX 7590

20 mm	S	10	RX 7590

Round Nose Tipped Pliers with Synthetic Handle



7590-7591

20 mm	S	10	7590
20 mm	S	10	7590 CO
38.5 mm	M	1	7591

Long Round Nose Pliers with Synthetic Handle



HS 7590

S	1	HS 7590

CHAIN NOSE

ERGO™ 60° Bent Tip Snipe Nose Pliers with Dual-Component Synthetic Handle



RX 7892

29 mm	M	10	RX 7892

Long Snipe Nose Pliers with Dual-Component Synthetic Handle



HS 7890-HS 7891

M	1	HS 7890
M	10	HS 7891

BENT NOSE

60° Bent Tip Snipe Nose Pliers with Synthetic Handle



7892

20 mm	M	10	7892
20 mm	M	10	7892 CO

ERGO™ Snipe Nose Pliers with Dual-Component Synthetic Handle



RX 7890-RX 7891

32 mm	S	10	RX 7890
32 mm	S	10	RX 7891

CHAINMAILLE PLIER

ERGO™ Precision Chainmaille Flat Straight Nose Stubby Pliers with Synthetic Handle



RX 7390

11 mm	S	10	RX 7390

Long 60° Bent Tip Snipe Nose Pliers with Synthetic Handle



HS 7892

M	1	HS 7892

Snipe Nose Pliers with Dual-Component Synthetic Handle



7890-7891

32.5 mm	M	10	7890
32.5 mm	M	10	7891
32.5 mm	M	10	7890 CO
32.5 mm	M	10	7891 CO

ERGO™ Precision Chainmaille Flat Oblique Nose Stubby Pliers with Synthetic Handle



RX 7392

12 mm	S	10	RX 7392

SHOULDER NOSE

ERGO™ Short Snipe Nose Pliers with Dual-Component Synthetic Handle



RX 7893

20 mm	S	10	RX 7893

Short Snipe Nose Pliers with Synthetic Handle



7893

20 mm	S	10	7893

Long Short Snipe Nose Pliers with Synthetic Handle



HS 7893

S	1	HS 7893

SNIPE NOSE, UNIQUE HEAD

Short Snipe Nose Pliers with Synthetic Handle



7893K

20 mm	S	10	7893K

NEEDLE NOSE

ERGO™ Precision Needle Nose Holding Pliers with smooth Jaws



ergo



RX 7894

L	10	RX 7894

Long Needle Nose Pliers with Synthetic Handle



HS 7894

L	1	HS 7894

Precision Needle Nose Holding Pliers with smooth Jaws & ESD Safe Handle



7894

L	10	7894

SHEAR CUTTERS

TAPERED HEAD

Micro Edge Shear Cutter with Tapered Head



6151

Micro Edge	0.2-1.6	0.01-0.06	10	6151

Flush Edge Shear Cutter with Tapered Head



6152

Flush Edge	0.2-1.6	0.01-0.06	10	6152

Stainless Steel Flush Edge Shear Cutter with Tapered Head



6152SS

Flush Edge	0.2-1.6	0.01-0.06	10	6152SS

POINTY HEAD

Flush Edge Shear Cutter with Pointy Head



6159



Flush Edge 0.2-1.0/0.01-0.039 10 6159

OBLIQUE HEAD

Flush Edge Shear Cutter with Oblique Head



6258



Flush Edge 0.2-1.0/0.01-0.039 10 6258

PRECISION SCREWDRIVERS

ESD SAFE

Slotted ESD Safe Precision Screwdrivers 1.5-3.0 mm



800ESD



1.5 mm	50 mm	10	800-1.5-50ESD
2.0 mm	50 mm	10	800-2-50ESD
2.5 mm	50 mm	10	800-2.5-50ESD
3.0 mm	50 mm	10	800-3-50ESD

Phillips ESD Safe Precision Screwdrivers PH00-PH1



801ESD



PH00	50 mm	10	801-00-50ESD
PH0	50 mm	10	801-0-50ESD
PH1	75 mm	10	801-1-75ESD

TORX® ESD Safe Precision Screwdrivers T6-T20



803ESD



T6	50 mm	10	803-6-50ESD
T7	50 mm	10	803-7-50ESD
T8	50 mm	10	803-8-50ESD
T9	50 mm	10	803-9-50ESD
T10	50 mm	10	803-10-50ESD
T15	75 mm	10	803-15-75ESD
T20	75 mm	10	803-20-75ESD

Pentalobe ESD Safe Precision Screwdrivers TS1-TS5



805ESD



TS1	50 mm	10	805-TS1-50ESD
TS4	50 mm	10	805-TS4-50ESD
TS5	50 mm	10	805-TS5-50ESD

Slotted/Phillips ESD Safe Precision Screwdriver Set 1.5-3.0mm/PH00-PH1 - 7 Pcs



801-7ESD

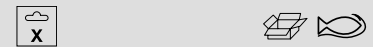

7 1 801-7ESD

800-1.5-50ESD, 800-2-50ESD, 800-2.5-50ESD, 800-3-50ESD

801-00-50ESD, 801-0-50ESD, 801-1-75ESD

TORX® ESD Safe Precision Screwdriver Set T6-T20 - 7 Pcs



803-7ESD



7 1 803-7ESD

803-6-50ESD, 803-7-50ESD, 803-8-50ESD, 803-9-50ESD, 803-10-50ESD, 803-15-75ESD, 803-20-75ESD

▶ WIRE STRIPPERS

DIAGONAL CUTTERS

Precision Diagonal Cutters with Oval Head - Stripping Accessory & ESD Safe Handle



8150SK

0.01-0.06 / 0.3-1.6	Micro-Bevel®	10	8150 SK

Precision Diagonal Wire Strippers & Cutters with Oval Head & ESD Safe Handle



8150J-8160J

0.02 / 0.5	Micro-Bevel®	10	8150 J
Max0.02 / Max	Micro-Bevel®	10	8160 J

▶ HEAVY DUTY CUTTERS

DIAGONAL CUTTER

Heavy Duty Diagonal Cutters with Dual-Component Handle



TRX 8180

4.5 mm	2.5 mm	5	TRX 8180



▶ TORQUE TOOLS

TORQUE SCREWDRIVERS

Adjustable Torque Screwdrivers with Window Scale and ESD Safe



MA500-1A - MA500-3A

16-80 cNM	1/4 in	1	MA500-1A
40-200 cNM	1/4 in	1	MA500-2A
90-450 cNM	1/4 in	1	MA500-3A

Pre-Set Torque Screwdrivers with Window Scale and ESD Safe



PS501

4-22 cNM	1/4 in	1	PS501-1
7-70 cNM	1/4 in	1	PS501-2
15-170 cNM	1/4 in	1	PS501-3
45-450 cNM	1/4 in	1	PS501-4

TWEEZERS

TWEEZER SETS

Set of 5 Tweezers Tip Style SS-SA, 2A-SA, 7A-SA, AA-SA



9855



10 x 200 x 110 mm



1 9855

9855W

TL SS-SA-SL

TL AA-SA-SL

TL 2A-SA-SL

TL 7A-SA-SL

TL 4-SA-SL

Set of 5 Tweezers Tip Style 00-SA, 1-SA, 3C-SA, 5-SA, 7-SA



9857



10 x 200 x 110 mm



1 9857

TL 00-SA-SL

TL 1-SA-SL

TL 5-SA-SL

TL 7-SA-SL

TL 3C-SA-SL

9855W

Set of 2 Tweezers Tip Style AA-SA, SS-SA



9858



8 x 200 x 65 mm



1 9858

9858W

TL AA-SA-SL

TL SS-SA-SL

Set of 2 Tweezers Tip Style 00B-SA, 2A-SA



9859



8 x 200 x 65 mm



1 9859

9858W

TL 00B-SA

TL 2A-SA-SL

Set of 5 High Precision Tweezers Tip Style 00-SA, 2A-SA, 3C-SA, 5-SA, 7-SA



9860



12 x 105 x 185 mm



1 9860

Set of 5 Economy Tweezers Tip Style 00-SA, 2A-SA, 3C-SA, 5-SA, 7-SA



9861



10 x 70 x 165 mm



1 9861

Set of 4 Economy Tweezers Tip Style 2A-SA, 3C-SA, 7A-SA, AA-SA



9862



10 x 70 x 165 mm



1 9862

Set of 5 SMD and Economy Tweezers Tip Style SM103-SA, SM108-SA, 3-SA, 5-SA, 7A-SA



9863



10 x 70 x 165 mm



1 9863

CUTTING TWEEZERS

Carbon Steel Cutting Tweezers Style 15A with Angled Blades



TL 15A



15A 120 mm 1 TL 15A

Carbon Steel Cutting Tweezers Style 15AGW with Predominantly Angled Blades



TL 15AGW



15AGW 115 mm 1 TL 15AGW

Stainless Steel Cutting Tweezers Style 15AGWHM with Tungsten Carbide Inserts and Predominantly Angled Blades



TL 15AGWHM-SA



15AGWHM 115 mm 1 TL 15AGWHM-SA

HIGH PRECISION TWEEZERS

Stainless Steel High Precision Tweezers Style 00B with Serrated Handles and Thick, Strong tips



TL 00B-SA

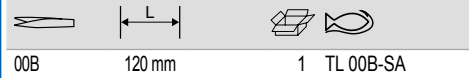

00B 120 mm 1 TL 00B-SA

Stainless steel, anti-magnetic, anti-acid

Stainless Steel High Precision Tweezers Style 00D with Serrated Handles and Thick, Strong, Linearly Serrated Tips



TL 00D-SA

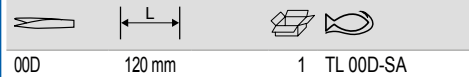

00D 120 mm 1 TL 00D-SA

Stainless steel, anti-magnetic, anti-acid

Stainless Steel High Precision Tweezers Style 00 with Thick and Strong Tips



TL 00-SA

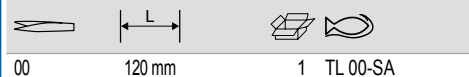

00 120 mm 1 TL 00-SA

Stainless steel, anti-magnetic, anti-acid

Stainless Steel High Precision Tweezers Style 000 with Fine Tips



TL 000-SA

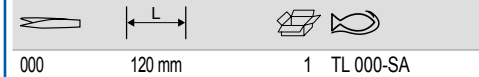

000 120 mm 1 TL 000-SA

Stainless Steel High Precision Tweezers Style 009 with Fine and Sharp Tips



TL 009-SA

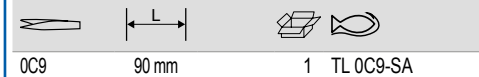

009 90 mm 1 TL 009-SA

Stainless steel, anti-magnetic, anti-acid

Stainless Steel High Precision Tweezers Style 1 with Fine and Sharp Tips



TL 1-SA



1 120 mm 1 TL 1-SA

Stainless steel, anti-magnetic, anti-acid

Stainless Steel High Precision Tweezers Style 2A with Very Fine, Round and Flat Tips



TL 2A-SA

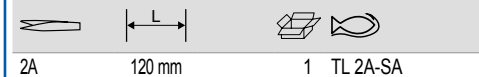

2A 120 mm 1 TL 2A-SA

Stainless steel, anti-magnetic, anti-acid

Stainless Steel High Precision Tweezers
Style 3C with Fine and Pointed Tips



TL 3C-SA

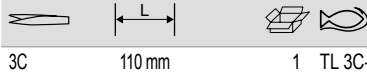

3C 110 mm 1 TL 3C-SA

Stainless steel, anti-magnetic, anti-acid

Stainless Steel High Precision Tweezers
Style 3 with Fine and Pointed Tips



TL 3-SA

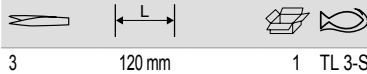

3 120 mm 1 TL 3-SA

Stainless steel, anti-magnetic, anti-acid

Stainless Steel High Precision Tweezers
Style 51S with Bent and Very Fine Tips



TL 51S-SA

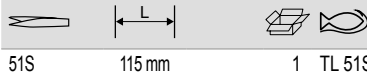

51S 115 mm 1 TL 51S-SA

Stainless steel, anti-magnetic, anti-acid

Stainless Steel High Precision Tweezers
Style 5 with Very Fine Sharp Tips



TL 5-SA

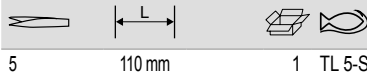

5 110 mm 1 TL 5-SA

Stainless steel, anti-magnetic, anti-acid

Stainless Steel High Precision Tweezers
Style SS with Very Fine and Very Sharp
Tips



TL SS-SA

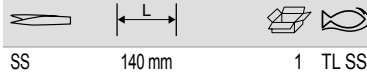

SS 140 mm 1 TL SS-SA

Stainless steel, anti-magnetic, anti-acid

Stainless Steel High Precision Tweezers
Style 7A with Very Fine and Curved Tips



TL 7A-SA

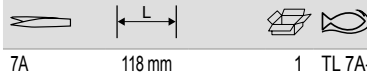

7A 118 mm 1 TL 7A-SA

Stainless steel, anti-magnetic, anti-acid

Stainless Steel High Precision Tweezers
Style 7 with Very Fine and Curved Tips



TL 7-SA

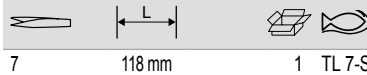

7 118 mm 1 TL 7-SA

Stainless steel, anti-magnetic, anti-acid

Stainless Steel High Precision Tweezers
Style 5B with Bent, Very Fine Sharp Tips



TL 5B-SA

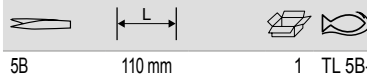

5B 110 mm 1 TL 5B-SA

Stainless steel, anti-magnetic, anti-acid

Stainless Steel High Precision Tweezers
Style 65A with Bent, Very Fine and Very
Sharp Tips



TL 65A-SA

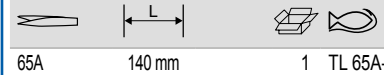

65A 140 mm 1 TL 65A-SA

Stainless steel, anti-magnetic, anti-acid

Stainless Steel High Precision Tweezers
Style 34A with Serrated Handles and
Smooth, Thin, Squared, Flat Tips



TL 34A-SA

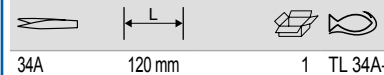

34A 120 mm 1 TL 34A-SA

Stainless Steel High Precision Tweezers
Style 6 with Angled and Very Fine Tips



TL 6-SA

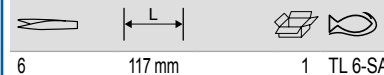

6 117 mm 1 TL 6-SA

PLASTIC REPLACEABLE TIP TWEEZERS

Carbon Fibre Plastic Replaceable Tip ESD Safe Tweezers Style 242CFR with Fine Tips



TL 242CFR-SA

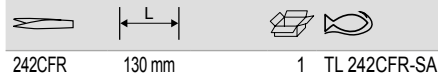

242CFR 130 mm 1 TL 242CFR-SA

Carbon Fibre Plastic Replaceable Tip ESD Safe Tweezers Style 249CFR with Thick, Beveled and Strong Tips



TL 249CFR-SA

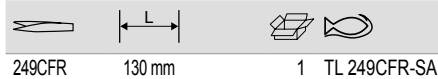

249CFR 130 mm 1 TL 249CFR-SA

Stainless steel body and carbon fibre tips

Carbon Fibre Plastic Replaceable Tip ESD Safe Tweezers Style 259CFR with Fine, Pointed and Strong Tips



TL 259CFR-SA



259CFR 130 mm 1 TL 259 CFR-SA

Stainless steel body and carbon fibre tips

Carbon PEEK Plastic Replaceable Tip ESD Safe Tweezers Style 259CPR with Fine, Pointed and Strong Tips



TL 259CPR-SA



259CPR 130 mm 1 TL 259CPR-SA

Carbon PEEK Plastic Replaceable Tip ESD Safe Tweezers Style 259CPR with Fine, Pointed and Strong Tips



TL 259CPR-SA



259CPR 130 mm 1 TL 259CPR-SA

Carbon Fibre Plastic Replaceable Tip ESD Safe Tweezers Style 00CFR with Thick and Squared Tips



TL 00CFR-SA



00CFR 130 mm 1 TL 00CFR-SA

Stainless steel body and carbon fibre tips

PVDF Plastic Replaceable Tip ESD Safe Tweezers Style 259SVR with Fine, Pointed and Strong Tips



TL 259SVR-SA



259SVR 130 mm 1 TL 259SVR-SA

Carbon Fibre Plastic Replaceable Tip ESD Safe Tweezers Style 2ACFR with Very Fine and Round Flat Tips



TL 2ACFR-SA



2ACFR 130 mm 1 TL 2ACFR-SA

Stainless steel body and carbon fibre tips

Carbon Fibre Plastic Replaceable Tip ESD Safe Tweezers Style 5CF with Very Fine and Sharp Tips



TL 5CF-SA

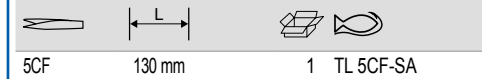

5CF 130 mm 1 TL 5CF-SA

Carbon Fibre Plastic Replaceable Tip ESD Safe Tweezers Style 5CFR with Very Fine and Sharp Tips



TL 5CFR-SA

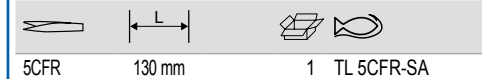

5CFR 130 mm 1 TL 5CFR-SA

Stainless steel body and carbon fibre tips

Carbon PEEK Plastic Replaceable Tip ESD Safe Tweezers Style 5CPR with Very Fine and Sharp Tips



TL 5CPR-SA



5CPR 130 mm 1 TL 5CPR-SA

PVDF Plastic Replaceable Tip ESD Safe Tweezers Style 5SVR with Very Fine and Sharp Tips



TL 5SVR-SA



5SVR 130 mm 1 TL 5SVR-SA

Carbon PEEK Plastic Replaceable Tip ESD Safe Tweezers Style 7CPR with Very Fine and Curved Tips



TL 7CPR-SA

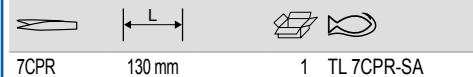

7CPR 130 mm 1 TL 7CPR-SA

PVDF Plastic Replaceable Tip ESD Safe Tweezers Style 7SVR with Very Fine and Curved Tips



TL 7SVR-SA



7SVR 130 mm 1 TL 7SVR-SA

Carbon Fibre Plastic Replaceable Tip ESD Safe Tweezers Style 7CFR with Very Fine and Curved Tips



TL 7CFR-SA



7CFR 130 mm 1 TL 7CFR-SA

Stainless steel body and carbon fibre tips

ESD SAFE ERGONOMIC TOUCH TWEEZERS

Stainless Steel ESD Safe Ergonomic Tweezers Style 00 with Thick and Strong Tips



TL 00-SA-ET

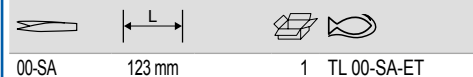

00-SA 123 mm 1 TL 00-SA-ET

Stainless Steel ESD Safe Ergonomic Tweezers Style 2A with Round, Flat and Very Fine Tips



TL 2A-SA-ET

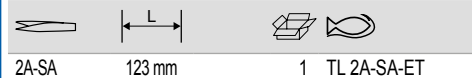

2A-SA 123 mm 1 TL 2A-SA-ET

Stainless Steel ESD Safe Ergonomic Tweezers Style 3 with Pointed and Fine Tips



TL 3-SA-ET

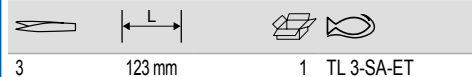

3 123 mm 1 TL 3-SA-ET

Stainless Steel ESD Safe Ergonomic Tweezers Style 3C with Pointed and Fine Tips



TL 3C-SA-ET



3C-SA 112 mm 1 TL 3C-SA-ET

Stainless Steel ESD Safe Ergonomic Tweezers Style 5 with Sharp and Fine Tips



TL 5-SA-ET



5-SA 112 mm 1 TL 5-SA-ET

Stainless Steel ESD Safe Ergonomic Tweezers Style AA with Sharp, Fine Tips



TL AA-SA-ET



AA-SA 130 mm 1 TL AA-SA-ET

Stainless Steel ESD Ergonomic Tweezers Style SM116 with Grooved Tips for Positioning Vertical Cylindrical Devices



TL SM116-SA-ET



SM116 115 mm 1 TL SM116-SA-ET

Stainless Steel ESD Safe Ergonomic Tweezers Style 7A with Curved and Fine Tips



TL 7A-SA-ET



7A 122 mm 1 TL 7A-SA-ET

Stainless Steel ESD Safe Ergonomic Tweezers Style 7 with Curved, Very Fine Tips



TL 7-SA-ET



7-SA 122 mm 1 TL 7-SA-ET

ECONOMY TWEEZERS

Stainless Steel Economy Tweezers Style 00 with Thick and Strong Tips



TL 00-SA-SL



00 120 mm 5 TL 00-SA-SL

Stainless Steel Economy Tweezers Style 1 with Sharp and Fine Tips



TL 1-SA-SL



1 120 mm 5 TL 1-SA-SL

Stainless Steel Economy Tweezers Style 2A with Flat and Fine Round Tips



TL 2A-SA-SL



2A 118 mm 5 TL 2A-SA-SL

Stainless Steel Economy Tweezers Style 2 with Pointed and Very Fine Tips



TL 2-SA-SL



2 120 mm 5 TL 2-SA-SL

Stainless Steel Economy Tweezers Style 3C with Pointed and Fine Tips



TL 3C-SA-SL

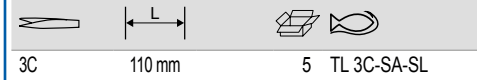

3C 110 mm 5 TL 3C-SA-SL

Stainless Steel Economy Tweezers Style 3 with Pointed and Fine Tips



TL 3-SA-SL



3 125 mm 5 TL 3-SA-SL

Stainless Steel Economy Tweezers Style 4 with Sharp and Fine Tips



TL 4-SA-SL

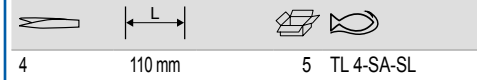

4 110 mm 5 TL 4-SA-SL

Stainless Steel Economy Tweezers Style 5A with Sharp and Fine Tips



TL 5A-SA-SL



5A 110 mm 5 TL 5A-SA-SL

Stainless Steel Economy Tweezers Style 5A with Sharp and Fine Tips



TL 5-SA-SL



5 110 mm 5 TL 5-SA-SL

Stainless Steel Economy Tweezers Style AC with Serrated Handles and Strong Tips



TL AC-SA-SL



AC 110 mm 5 TL AC-SA-SL

Stainless Steel Economy Tweezers Style SS with Very Sharp and Fine Tips



TL SS-SA-SL



SS 140 mm 5 TL SS-SA-SL

Stainless Steel Economy Tweezers Style AA with Sharp and Fine Tips



TL AA-SA-SL



AA 128 mm 5 TL AA-SA-SL

Stainless Steel Economy Tweezers Style MM with Pointed, Strong and Fine Tips



TL MM-SA-SL



MM 125 mm 5 TL MM-SA-SL

Stainless Steel Economy Tweezers Style 7A with Curved and Fine Tips



TL 7A-SA-SL



7A 120 mm 5 TL 7A-SA-SL

Stainless Steel Economy Tweezers Style 7 with Curved and Fine Tips



TL 7-SA-SL



7 120 mm 5 TL 7-SA-SL

SMD TWEEZERS

Stainless Steel SMD Tweezers Style SMD 104 for Positioning SOT Packages and Monolithic Chip Capacitors



TL SM104-SA



SM104 120 mm 1 TL SM 104-SA

Stainless steel, anti-magnetic, anti-acid

Stainless Steel SMD Tweezers Style SMD 105 with Hammer Shaped Tips for Positioning Vertical SOT Packages



TL SM105-SA



SM105 120 mm 1 TL SM 105-SA

Stainless steel, anti-magnetic, anti-acid

Stainless Steel SMD Tweezers Style SMD 106 with Fine Shaped Tips for Positioning Horizontal SOT Packages



TL SM106-SA



SM106 120 mm 1 TL SM106-SA

Stainless Steel SMD Tweezers Style SMD 108 for Soldering 1mm Wide Components



TL SM108-SA



SM108 120 mm 1 TL SM 108-SA

Stainless steel, anti-magnetic, anti-acid

Stainless Steel SMD Tweezers Style SMD 109 for Soldering 1mm Wide Components at 45° Angle



TL SM109-SA



SM109 120 mm 1 TL SM 109-SA

Stainless steel, anti-magnetic, anti-acid

Stainless Steel SMD Tweezers Style SMD 110 with Grooved Tips for Positioning Cylindrical Devices



TL SM110-SA



SM110 120 mm 1 TL SM 110-SA

Stainless steel, anti-magnetic, anti-acid

Stainless Steel SMD Tweezers Style SMD 111 with Grooved Tips for Positioning 0.5mm Cylindrical Devices



TL SM111-SA



SM111 115 mm 1 TL SM 111-SA

Stainless steel, anti-magnetic, anti-acid

Stainless Steel SMD Tweezers Style SMD 116 with Grooved Tips for Positioning Vertical Cylindrical Devices



TL SM116-SA



SM116 115 mm 1 TL SM116-SA

Stainless Steel SMD Tweezers Style SMD 107 with Double Bent Tips for Positioning Flat Devices



TL SM107-SA



SM107 120 mm 1 TL SM 107-SA

Stainless steel, anti-magnetic, anti-acid



Stainless Steel SMD Tweezers Style SMD 103 for Handling and Positioning at a 45° Angle



TL SM103-SA

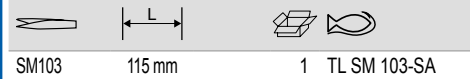

SM103 115 mm 1 TL SM 103-SA

Stainless steel, anti-magnetic, anti-acid

Stainless Steel SMD Tweezers Style SMD 115 with 45° Angled Grooved Tips for Positioning 0.6mm Cylindrical Devices



TL SM115-SA



SM115 115 mm 1 TL SM 115-SA

Stainless steel, anti-magnetic, anti-acid

Stainless Steel SMD Tweezers Style SMD 117 with 20° Angled Squared Tips for Positioning SOT Packages



TL SM117-SA



SM117 120 mm 1 TL SM 117-SA

Stainless steel, anti-magnetic, anti-acid

COMPONENTS POSITIONING TWEEZERS

Stainless Steel Component Positioning Tweezers Style 578 with Serrated Handles and Grooved Tips for 2 mm Cylindrical Devices



TL 578-SA

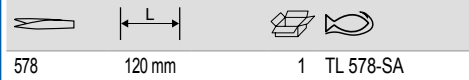

578 120 mm 1 TL 578-SA

Stainless steel, anti-magnetic, anti-acid

Stainless Steel Component Positioning Tweezers Style 582 with Serrated Handles and Grooved Tips for 1 mm Cylindrical Devices



TL 582-SA

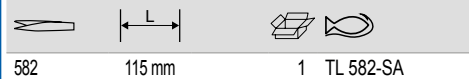

582 115 mm 1 TL 582-SA

Stainless steel, anti-magnetic, anti-acid

GENERAL PURPOSE TWEEZERS

Stainless Steel General Purpose Tweezers Style 475 with Serrated Handles and Beveled, Strong, Linearly Serrated Tips



TL 475-SA



475 136 mm 1 TL 475-SA

Stainless steel, anti-magnetic, anti-acid

Stainless Steel General Purpose Tweezers Style 648 with Serrated Handles and Beveled, Thick, Strong, Sharp, Linearly Serrated Tips



TL 648-SA



648 155 mm 1 TL 648-SA

Stainless steel, anti-magnetic, anti-acid

Stainless Steel General Purpose Tweezers Style 124 with Serrated Handles and Bent, Rhombic Serrated, Fine Tips



TL 124-SA

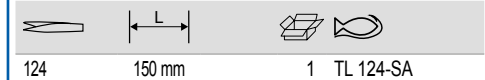

124 150 mm 1 TL 124-SA

Stainless steel, anti-magnetic, anti-acid

Stainless Steel General Purpose Tweezers Style 649 with Serrated Handles and Bent, Beveled, Thick, Strong, Linearly Serrated Tips



TL 649-SA



649 154 mm 1 TL 649-SA

Stainless steel, anti-magnetic, anti-acid

SPARE PARTS & ACCESSORIES

Set of 2 Carbon Fibre Tips and 3 Screws with Straight, Thick and Strong Tips TL 00CFR-SA



TL 00ACF



Set of 2 Carbon Fibre Tips and 3 Screws with Straight, Thick, Beveled and Strong Tips for TL 249CFR-SA



TL 249ACF



Set of 2 Carbon Fibre Tips and 3 Screws with Straight, Fine, Pointed and Strong Tips for TL 259CFR-SA



TL 259ACF



Set of 2 Carbon Fibre Tips and 3 Screws with Straight, Very Fine, Round and Flat Tips for TL 2ACFR-SA-TL 2AXCFR-SA



TL 2AACF



Set of 2 Carbon PEEK Tips and 3 Screws with Straight, Fine, Pointed and Strong Tips for TL 259CPR-SA



TL 259ACP

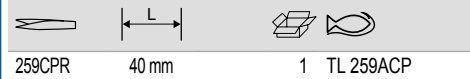

Set of 2 PVDF Tips and 3 Screws and Straight, Very Fine and Sharp Tips for TL 5SVR-SA-TL 5XSVR-SA



TL 5ASV



Set of 2 Carbon Fibre Tips and 3 Screws with Straight and Fine Tips for TL 242CFR-SA



TL 242ACF



Set of 2 PVDF Tips and 3 Screws with Straight, Fine, Pointed and Strong Tips for TL 259SVR-SA



TL 259ASV



Set of 2 Carbon Fibre Tips and 3 Screws with Straight, Very Fine and Sharp Tips for TL 5CFR-SA-TL 5XCFR-SA



TL 5ACF



Set of 2 Carbon Fibre Tips and 3 Screws with Curved and Very Fine Tips for TL 7CFR-SA



TL 7ACF



7CFR 40 mm 1 TL 7ACF

Set of 2 Carbon PEEK Tips and 3 Screws with Straight, Very Fine and Sharp Tips for TL 5CPR-SA-TL 5XCPR-SA



TL 5ACP

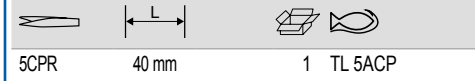

5CPR 40 mm 1 TL 5ACP

Set of 2 PVDF Tips and 3 Screws with Curved and Very Fine Tips for TL 7SVR-SA



TL 7ASV



7SVR 40 mm 1 TL 7ASV

Set of 2 Carbon PEEK tips and 3 Screws with Curved and Very Fine Tips for TL 7CPR-SA



TL 7ACP

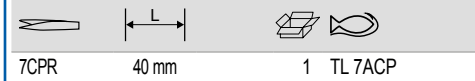

7CPR 40 mm 1 TL 7ACP



1-100-04-1-0	7311518019006	10	22
1-100-04-1-2	7311518244125	5	22
1-100-04-2-0	7311518019013	10	22
1-100-04-2-2	7311518244132	5	22
1-100-04-3-0	7311518019020	10	22
1-100-06-1-0	7311518019037	10	22
1-100-06-1-2	7311518000233	5	22
1-100-06-2-0	7311518019044	10	22
1-100-06-2-2	7311518003593	5	22
1-100-06-3-0	7311518019051	10	22
1-100-06-3-2	7311518293581	5	22
1-100-08-1-0	7311518019068	10	22
1-100-08-1-2	7311518000264	5	22
1-100-08-2-0	7311518019075	10	22
1-100-08-2-2	7311518003609	5	22
1-100-08-3-0	7311518019082	10	22
1-100-08-3-2	7311518295585	5	22
1-100-10-1-0	7311518019099	10	22
1-100-10-1-2	7311518000295	5	22
1-100-10-2-0	7311518019105	10	22
1-100-10-2-2	7311518003616	5	22
1-100-10-3-0	7311518019112	10	22
1-100-10-3-2	7311518295592	5	22
1-100-12-1-0	7311518019129	5	22
1-100-12-1-2	7311518028053	5	22
1-100-12-2-0	7311518019136	5	22
1-100-12-2-2	7311518244118	5	22
1-100-12-3-0	7311518019143	5	22
1-100-12-3-2	7311518295608	5	22
1-100-14-1-0	7311518019150	5	22
1-100-14-2-0	7311518019167	5	22
1-102-06-2-0	7311518019198	10	22
1-102-06-3-0	7311518019204	10	22
1-102-08-1-0	7311518019211	10	22
1-102-08-2-0	7311518019228	10	22
1-102-08-3-0	7311518019235	10	22
1-104-10-2-0	7311518019242	10	22
1-104-10-3-0	7311518019259	10	22
1-104-12-2-0	7311518019266	5	22
1-104-12-3-0	7311518019273	5	22
1-104-14-3-0	7311518019297	5	22
1-106-08-1-0	7311518019303	10	22
1-106-08-1-2	7311518000301	5	22
1-106-10-1-0	7311518019310	10	22
1-106-10-1-2	7311518000325	5	22
1-106-12-1-0	7311518019327	5	22
1-106-12-1-2	7311518295615	5	22
1-110-04-1-0	7311518019334	10	22
1-110-04-2-0	7311518019341	10	22
1-110-04-3-0	7311518044046	10	22
1-110-06-1-0	7311518019358	10	22
1-110-06-1-2	7311518295622	5	23
1-110-06-2-0	7311518019365	10	22
1-110-06-2-2	7311518003623	5	23
1-110-06-3-0	7311518019372	10	22
1-110-06-3-2	7311518295639	5	23
1-110-08-1-0	7311518019389	10	22
1-110-08-1-2	7311518000332	5	23
1-110-08-2-0	7311518019396	10	22
1-110-08-2-2	7311518003630	5	23
1-110-08-3-0	7311518019402	10	22
1-110-08-3-2	7311518295646	5	23
1-110-10-1-0	7311518019419	10	22
1-110-10-1-2	7311518000349	5	23
1-110-10-2-0	7311518019426	10	22
1-110-10-2-2	7311518003647	5	23
1-110-10-3-0	7311518019433	10	22
1-110-10-3-2	7311518295653	5	23
1-110-12-1-0	7311518019440	5	22
1-110-12-1-2	7311518295660	5	23
1-110-12-2-0	7311518019457	5	22
1-110-12-2-2	7311518295677	5	23
1-110-12-3-0	7311518019464	5	22
1-110-12-3-2	7311518295684	5	23
1-110-14-1-0	7311518019488	5	22
1-111-04-1-0	7311518044053	10	23
1-111-04-2-0	7311518019518	10	23
1-111-04-3-0	7311518019525	10	23
1-111-06-1-0	7311518019549	10	23
1-111-06-2-0	7311518019556	10	23
1-111-06-2-2	7311518000363	5	23
1-111-06-3-0	7311518019563	10	23
1-111-08-1-0	7311518019570	10	23
1-111-08-2-0	7311518019587	10	23
1-115-11-3-1	7311518003791	10	23
1-143-04-1-0	7311518105983	10	23
1-143-06-1-0	7311518019631	10	23
1-143-06-1-2	7311518022341	5	23
1-143-08-1-0	7311518019662	10	23
1-143-08-1-2	7311518028077	5	23
1-143-10-1-0	7311518019693	10	23
1-143-10-1-2	7311518022358	5	23
1-143-12-1-0	7311518019723	5	23
1-143-12-1-2	7311518295691	5	23
1-160-04-1-0	7311518019785	10	25
1-160-04-1-2	7311518244057	5	25



1-160-04-2-0	7311518019792	10	25
1-160-04-2-2	7311518244095	5	25
1-160-04-3-0	7311518019808	10	25
1-160-06-1-0	7311518019815	10	25
1-160-06-1-2	7311518000370	5	25
1-160-06-2-0	7311518019822	10	25
1-160-06-2-2	7311518003685	5	25
1-160-06-3-0	7311518019839	10	25
1-160-06-3-2	7311518295707	5	25
1-160-08-1-0	7311518019846	10	25
1-160-08-1-2	7311518000394	5	25
1-160-08-2-0	7311518019853	10	25
1-160-08-2-2	7311518003692	5	25
1-160-08-3-0	7311518019860	10	25
1-160-08-3-2	7311518295714	5	25
1-160-10-1-0	7311518019877	10	25
1-160-10-1-2	7311518000400	5	25
1-160-10-2-0	7311518019884	10	25
1-160-10-2-2	7311518295721	5	25
1-160-10-3-0	7311518019891	10	25
1-160-10-3-2	7311518295738	5	25
1-160-12-1-0	7311518019907	5	25
1-160-12-1-2	7311518295745	5	25
1-160-12-2-0	7311518019914	5	25
1-160-12-2-2	7311518295752	5	25
1-160-12-3-0	7314150292059	5	25
1-160-12-3-2	7311518298005	5	25
1-170-04-1-0	7311518044060	10	24
1-170-04-2-0	7311518019945	10	24
1-170-04-2-2	7311518244088	5	24
1-170-04-3-0	7311518019952	10	24
1-170-06-1-0	7311518019969	10	24
1-170-06-1-2	7311518244071	5	24
1-170-06-2-0	7311518019976	10	24
1-170-06-2-2	7311518003715	5	24
1-170-06-3-0	7311518019983	10	24
1-170-06-3-2	7311518295769	5	24
1-170-08-1-0	7311518019990	10	24
1-170-08-1-2	7311518000417	5	24
1-170-08-2-0	7311518020002	10	24
1-170-08-2-2	7311518003722	5	24
1-170-08-3-0	7311518020019	10	24
1-170-08-3-2	7311518295783	5	24
1-170-10-1-0	7311518020026	10	24
1-170-10-1-2	7311518028107	5	24
1-170-10-2-0	7311518020033	10	24
1-170-10-2-2	7311518244064	5	24
1-170-10-3-0	7311518020040	10	24
1-170-10-3-2	7311518295806	5	24
1-170-12-1-0	7311518020057	5	24
1-170-12-2-0	7311518020064	5	24
1-210-04-1-0	7311518020071	10	24
1-210-04-1-2	7311518243944	5	24
1-210-04-2-0	7311518020088	10	24
1-210-04-2-2	7311518244040	5	24
1-210-04-3-0	7311518020095	10	24
1-210-06-1-0	7311518020101	10	24
1-210-06-1-2	7311518000424	5	24
1-210-06-2-0	7311518020118	10	24
1-210-06-2-2	7311518003654	5	24
1-210-06-3-0	7311518020125	10	24
1-210-06-3-2	7311518293574	5	24
1-210-08-1-0	7311518020132	10	24
1-210-08-1-2	7311518000455	5	24
1-210-08-2-0	7311518020149	10	24
1-210-08-2-2	7311518000479	5	24
1-210-08-3-0	7311518020156	10	24
1-210-08-3-2	7311518295837	5	24
1-210-10-1-0	7311518020163	10	24
1-210-10-1-2	7311518000493	5	24
1-210-10-2-0	7311518020170	10	24
1-210-10-2-2	7311518003661	5	24
1-210-10-3-0	7311518020187	10	24
1-210-10-3-2	7311518295844	5	24
1-210-12-1-0	7311518020194	5	24
1-210-12-1-2	7311518028121	5	24
1-210-12-2-0	7311518020200	5	24
1-210-12-2-2	7311518244149	5	24
1-210-12-3-0	7311518020217	5	24
1-210-12-3-2	7311518295851	5	24
1-210-14-1-0	7311518020224	5	24
1-230-04-1-0	7311518020248	10	24
1-230-04-1-2	7311518244163	5	24
1-230-04-2-0	7311518020255	10	24
1-230-04-2-2	7311518244156	5	24
1-230-04-3-0	7311518020262	10	24
1-230-06-1-0	7311518020279	10	24
1-230-06-1-2	7311518000509	5	24
1-230-06-2-0	7311518020286	10	24
1-230-06-2-2	7311518000523	5	24
1-230-06-3-0	7311518020293	10	24
1-230-06-3-2	7311518293567	5	24
1-230-08-1-0	7311518020309	10	24
1-230-08-1-2	7311518000547	5	24
1-230-08-2-0	7311518020316	10	24
1-230-08-2-2	7311518000554	5	24













1-230-08-3-0	7311518020323	10	24
1-230-08-3-2	7311518295882	5	24
1-230-10-1-0	7311518020330	10	24
1-230-10-1-2	7311518000578	5	24
1-230-10-2-0	7311518020347	10	24
1-230-10-2-2	7311518003678	5	24
1-230-10-3-0	7311518020354	10	24
1-230-10-3-2	7311518295899	5	24
1-230-12-1-0	7311518020361	5	24
1-230-12-1-2	7311518295912	5	24
1-230-12-2-0	7311518020378	5	24
1-230-12-2-2	7311518295929	5	24
1-230-12-3-0	7311518020385	5	24
1-230-12-3-2	7311518295905	5	24
1-320-08-2-0	7311518191276	10	23
1-320-08-2-2	7311518270865	5	23
1-320-10-2-0	7311518020477	10	23
1-320-10-2-2	7311518270872	5	23
1-320-12-2-0	7311518020484	5	23
1-473-06-2-2	7311518201098	5	25
1-473-08-2-2	7311518201104	5	25
1-473-10-2-2	7311518201111	5	25
1-476-04-3-2	7311518010928	1	25
1-477-08-2-2	7311518037994	5	25
1-477-10-2-2	7311518201074	5	26
1-478-08-1-2	7311518141127	5	26
1-478-10-1-2	7311518241995	5	26
1-479-08-1-2	7311518176747	5	26
1-479-08-2-2	7311518180607	5	26
10-21-51	7311518229344	5	633
10-24-23	7311518229368	5	633
10-24-51	7311518229351	5	633
10-30-23	7311518229382	5	633
10-30-51	7311518229375	5	633
1016	7314150218189	10	218
1019	8412814010199	10	218
1031-10	7314150025442	5	571
1031-12	7314150025459	5	571
1031-14	7314150025466	5	571
1031-16	7314150025473	5	571
1031-18	7314150025480	5	571
1031-20	7314150025497	5	571
1031-22	7314150025503	5	571
1031-25	7314150025510	5	571
1031-28	7314150025527	5	571
1031-30	7314150025534	5	571
1031-32	7314150025541	5	571
1031-4	7314150025411	5	571
1031-40	7314150025558	5	571
1031-6	7314150025428	5	571
1031-8	7314150025435	5	571
1067	8412814010670	10	218
1084	7311518277291	5	270
10RM-10	7314153014351	1	45
10RM-13	7314153014368	1	45
10RM-14	7314150221677	1	45
10RM-17	7314153014375	1	45
10RM-19	7314153014382	1	45
10RM-8	7314153014344	1	45
10RM/SH6	7314150222971	1	46
10RZ-1/2	7314150358786	1	45
10RZ-11/16	7314150358816	1	45
10RZ-3/4	7314150358823	1	45
10RZ-3/8	7314150358762	1	45
10RZ-5/16	7314150358748	1	45
10RZ-5/8	7314150358809	1	45
10RZ-7/16	7314150358779	1	45
10RZ-9/16	7314150358793	1	45
111A	7314150476183	5	653
111M-10	7314151828653	10	40
111M-100	7314150401499	1	40
111M-11	7314151828660	10	40
111M-12	7314151828677	10	40
111M-13	7314151828684	10	40
111M-14	7314151828691	10	40
111M-15	7314151828707	10	40
111M-16	7314151828714	10	40
111M-17	7314151828721	10	40
111M-18	7314151828738	10	40
111M-19	7314151828745	10	40
111M-20	7314151828752	10	40
111M-21	7314151828769	10	40
111M-22	7314151828776	5	40
111M-23	7314151828783	5	40
111M-24	7314151828790	5	40
111M-25	7314151828806	5	40
111M-26	7314151828813	5	40
111M-27	7314151828820	5	40
111M-28	7314151828837	5	40
111M-29	7314151828844	5	40
111M-30	7314151828851	5	40
111M-32	7314151828868	5	40
111M-33	7314150222223	5	40
111M-34	7314151828875	5	40
111M-36	7314150135516	1	40
111M-38	7314150222230	1	40



111M-41	7314150135523	1	40
111M-46	7314150135530	1	40
111M-5.5	7314151828608	10	40
111M-50	7314150135547	1	40
111M-55	7314150135554	1	40
111M-6	7314151828615	10	40
111M-60	7314150135561	1	40
111M-65	7314150135578	1	40
111M-7	7314151828622	10	40
111M-70	7314150135585	1	40
111M-75	7314150135592	1	40
111M-8	7314151828639	10	40
111M-80	7314150135608	1	40
111M-85	7314150352999	1	40
111M-9	7314151828646	10	40
111M-90	7314150401475	1	40
111M-95	7314150401482	1	40
111M/11T	7314151828899	1	42
111M/14T	7314151828905	1	42
111M/17T	7314151828912	1	42
111M/17TL	7314150197859	1	42
111M/24T	7314150197866	1	42
111M/26T	7314151828929	1	42
111M/S10	7314150212965	1	42
111M/SH12	7314153013347	1	41
111M/SH5	7314150325252	1	41
111M/SH8	7314150197873	1	41
111Z-1	7314151829063	3	41
111Z-1.1/16	7314151829070	5	41
111Z-1.1/2	7314150135752	1	41
111Z-1.1/4	7314151829094	5	41
111Z-1.1/8	7314151829087	5	41
111Z-1.11/16	7314150135615	1	41
111Z-1.13/16	7314150135639	1	41
111Z-1.3/4	7314150135622	1	41
111Z-1.3/8	7314150135738	1	41
111Z-1.5/16	7314151829100	5	41
111Z-1.5/8	7314150135769	1	41
111Z-1.7/16	7314150135745	1	41
111Z-1.7/8	7314150135646	1	41
111Z-1/2	7314151828981	5	41
111Z-1/4	7314151828943	5	41
111Z-11/16	7314151829018	5	41
111Z-13/16	7314151829032	5	41
111Z-15/16	7314151829056	3	41
111Z-2	7314150135653	1	41
111Z-2.1/2	7314150135721	1	41
111Z-2.1/4	7314150135691	1	41
111Z-2.1/8	7314150135677	1	41
111Z-2.3/4	7314150135783	1	41
111Z-2.3/8	7314150135707	1	41
111Z-2.5/8	7314150135776	1	41
111Z-2.7/8	7314150135790	1	41
111Z-3	7314150135806	1	41
111Z-3/4	7314151829025	5	41
111Z-3/8	7314151828967	5	41
111Z-5/16	7314151828950	5	41
111Z-5/8	7314151829001	5	41
111Z-7/16	7314151828974	5	41
111Z-7/8	7314151829049	5	41
111Z-9/16	7314151828998	5	41
111Z/11T	7314151829124	1	43
111Z/8T	7314151829117	1	42
1150-1/2H/P	7314150129263	1	545
1150D	7311518276614	1	545
1154	7314150249831	1	326
1154-DG	7314150249800	1	326
1154-MB	7314150249817	1	326
1157	7311518277031	60	606
1162N-1/2	7314151847241	1	538
1177-SCRIBE	7314150120550	5	543
1178-SCRIBE	7314150120567	5	543
1179-FLX	7311518276997	25	543
1179-SCRIBE	7314150120574	5	543
1179-TIPS	7314150120581	1	543
11M-10	7314151829155	5	43
11M-11	7314151829162	5	43
11M-12	7314151829179	5	43
11M-13	7314151829186	5	43
11M-14	7314151829193	5	43
11M-15	7314151829209	5	43
11M-16	7314151829216	5	43
11M-17	7314151829223	5	43
11M-18	7314151829230	5	43
11M-19	7314151829247	5	43
11M-21	7314151829254	5	43
11M-22	7314151829261	5	43
11M-24	7314151829278	5	43
11M-27	7314151829285	1	43
11M-30	7314151829292	1	43
11M-32	7314151829308	1	43
11M-36	7314151829315	1	43
11M-38	7314151829322	1	43
11M-8	7314151829131	5	43
11M-9	7314151829148	5	43
11Z-1	7314150355303	5	43

11Z-1/2	7314150355235	5	43
11Z-11/16	7314150355266	5	43
11Z-13/16	7314150355280	5	43
11Z-3/4	7314150355273	5	43
11Z-3/8	7314150355211	5	43
11Z-5/8	7314150355259	5	43
11Z-7/16	7314150355228	5	43
11Z-9/16	7314150355242	5	43
121A	7314150476206	5	653
1300Z-1-1.1/8	7314153000989	1	52
1300Z-1/2-9/16	7314151039998	1	52
1300Z-1/4-5/16	7314153000965	1	52
1300Z-15/16-1	7314153005656	1	52
1300Z-19/32-11/16	7314151040000	1	52
1300Z-25/32-13/16	7314153000972	1	52
1300Z-3/8-7/16	7314151039981	1	52
1300Z-5/8-3/4	7314151040017	1	52
1300Z-7/8-15/16	7314153005649	1	52
1320RM-10-11	7314153014511	1	47
1320RM-12-13	7314153014528	1	47
1320RM-14-15	7314153014535	1	47
1320RM-16-17	7314153014542	1	47
1320RM-17-19	73141530359196	1	47
1320RM-18-19	7314153014559	1	47
1320RM-22-24	7314150221646	1	47
1320RM-6-7	7314153014498	1	47
1320RM-8-9	7314153014504	1	47
1320RM/SH8	7314150222988	1	47
1320RZ-1/2-9/16	7314153014580	1	47
1320RZ-1/4-5/16	7314153014566	1	47
1320RZ-3/4-13/16	7314150359264	1	47
1320RZ-3/4-7/8	7314150359271	1	47
1320RZ-3/8-7/16	7314153014573	1	47
1320RZ-5/16-11/32	7314153015235	60	47
1320RZ-5/8-11/16	7314150359257	1	47
1320RZ-7/8-15/16	7314150359288	1	47
1320SRM-14-19	7314150190355	1	47
1320SRM/S29	7314150188673	1	47
1321RZ-1/2-9/16	7314150359349	1	47
1321RZ-3/4-7/8	7314150359363	1	47
1321RZ-3/8-7/16	7314150359332	1	47
1321RZ-5/8-11/16	7314150359356	1	47
133SGM-100	7314151828523	1	55
133SGM-105	7314151828530	1	55
133SGM-110	7314151828547	1	55
133SGM-115	7314151828554	1	55
133SGM-120	7314151828561	1	55
133SGM-27	7314151828363	1	55
133SGM-30	7314151828370	1	55
133SGM-32	7314151828387	1	55
133SGM-36	7314151828394	1	55
133SGM-41	7314151828400	1	55
133SGM-46	7314151828417	1	55
133SGM-50	7314151828424	1	55
133SGM-55	7314151828431	1	55
133SGM-60	7314151828448	1	55
133SGM-65	7314151828455	1	55
133SGM-70	7314151828462	1	55
133SGM-75	7314151828479	1	55
133SGM-80	7314151828486	1	55
133SGM-85	7314151828493	1	55
133SGM-90	7314151828509	1	55
133SGM-95	7314151828516	1	55
14-24-3810	7311518002879	5	634
140	7314150008797	1	266
141	7314150008827	1	266
1410	7314150106332	1	266
1410D	7314150452842	1	266
1418-4	7314150510863	1	370
1418-5	7314150510870	1	370
1418-6	7314150510887	1	370
1418-7.5	7314150510894	1	370
1418-8.5	7314150510900	1	370
1418S	7314151040604	1	369
1419-M12	7314150257423	1	369
1419-M16	7314150358045	1	369
1419-M5	7314150257409	1	369
1419-M8	7314150257416	1	369
1419-MD	7311518277352	1	342
1419/4	7314150125036	1	369
142	7314150008841	1	266
1420	7314150103744	1	266
1420-1.4	7314151696337	1	369
1420D	7314150452859	1	266
1421-2.1	7314151696412	1	369
1422-3.1	7314151696689	1	369
1423-4.8	7314151696764	1	369
1424-6.2	7314151696849	1	369
143	7314150008872	1	266
1430FT120	7314150342006	1	384
1435/5	7314151040734	1	369
1435/8	7314151040741	1	369
144	7314150008902	1	266
1446	7314150128631	15	584
1446-CS	7314150508266	15	584
1446-FLOAT	7314150438464	15	584

1446-FLOAT-B	7314150524310	12	585
1446-OV	7314150313679	15	585
1450D-ISO	7314151040970	1	372
1450D-VWV	7314151040987	1	372
1450D/2	7314151040963	1	372
1460M/1	7314151041090	1	371
1460M/2	7314151041106	1	371
1460Z/2	7314151041120	1	372
1467-250	7314150124268	1	263
1467-320-850	7314150178636	1	263
1467-520	7314150124275	1	263
1467-LJ	7314150209033	1	264
1467-SJ	7314150208982	1	264
1468-10M10	7314150243457	1	349
1468-10M4	7314150243419	1	349
1468-10M5	7314150243426	1	349
1468-10M6	7314150243433	1	349
1468-10M8	7314150243440	1	349
1468-6M3	7314150243372	1	349
1468-6M4	7314150243389	1	349
1468-6M5	7314150243396	1	349
1468-6M6	7314150243402	1	349
1468-M10	7314150243228	6	348
1468-M6	7314150243211	1	348
147	7314150008933	1	266
147-1	7314150367047	1	117
147-1.1/4	7314150367061	1	117
147-1.1/8	7314150367054	1	117
147-1/2	7314150366965	1	117
147-11/16	7314150366996	1	117
147-13	7314150366644	1	117
147-13/16	7314150367016	1	117
147-14	7314150366651	1	117
147-15	7314150366668	1	117
147-15/16	7314150367030	1	117
147-16	7314150366675	1	117
147-17	7314150366682	1	117
147-18	7314150366699	1	117
147-19	7314150366705	1	117
147-21	7314150366712	1	117
147-22	7314150366729	1	117
147-24	7314150366736	1	117
147-25	7314150366743	1	117
147-27	7314150366750	1	117
147-3/4	7314150367009	1	117
147-30	7314150366767	1	117
147-32	7314150366774	1	117
147-33	7314150366781	1	117
147-34	7314150366798	1	117
147-35	7314150366804	1	117
147-36	7314150366811	1	117
147-37	7314150366828	1	117
147-38	7314150366835	1	117
147-39	7314150366842	1	117
147-41	7314150366859	1	117
147-45	7314150366866	1	117
147-46	7314150366873	1	117
147-5/8	7314150366989	1	117
147-50	7314150366880	1	117
147-55	7314150366897	1	117
147-60	7314150366903	1	117
147-65	7314150537860	1	117
147-68	7314150366910	1	117
147-7/16	7314150366958	1	117
147-7/8	7314150367023	1	117
147-70	7314150366927	1	117
147-75	7314150366934	1	117
147-9/16	7314150366972	1	117
147-90	7314150366941	1	117
1470K-AC1	7314150226498	1	382
1470K-AC2	7314150226504	1	382
1470K-AC3	7314150226511	1	382
1470K-AC4	7314150226528	1	382
1470K-AC7	7314150271320	1	383
1470K-AC8	7314150328581	1	383
1470K-AC8GR	7314150328598	1	383
1470K-ACSIDE	7314150226535	1	383
1470K-ACTD	7314150297269	1	382
1470K-ACTSS	7314150297283	1	382
1470K-ACTW	7314150297276	1	382
1470K7LH	7314150360444	1	381
1470K7LHBLUE	7314150407491	1	381
1470K7LHGREY	7314150407767	1	381
1470K7LHRED	7314150407507	1	381
1470K2	7314150226696	1	383
1470K3A	7314150506354	1	383
1470K5	7314150226665	1	383
1470K5PC	7314150226672	1	383
1470KCTRAY	7314150226702	1	383
1470KXL-ACTD	7314150297290	1	382
1470KXL-ACTSS	7314150297313	1	382
1470KXL-ACTW	7314150297306	1	382
1470KXLC-TRAY	7314150285549	1	383
1471KXXL12BKTS5	7314150365432	1	380
1472K-ACTD	7314150399345	1	380
1472K-ACTSS	7314150399338	1	380



1472K-ACTW



1472K-ACTW	7314150393152	1	380
1472K5	7314150349463	1	377
1472K5BLACK	7314150349500	1	377
1472K5BLUE	7314150349616	1	377
1472K5GREY	7314150403813	1	377
1472K5RED	7314150349562	1	377
1472K5WHITE	7314150403707	1	377
1472K6	7314150349470	1	377
1472K6BLACK	7314150349531	1	377
1472K6BLUE	7314150349623	1	377
1472K6GREY	7314150403820	1	377
1472K6RED	7314150349579	1	377
1472K6WHITE	7314150399888	1	377
1472K7	7314150349487	1	377
1472K7BLACK	7314150349548	1	377
1472K7BLUE	7314150349630	1	377
1472K7GREY	7314150403837	1	377
1472K7RED	7314150349586	1	377
1472K7WHITE	7314150403714	1	377
1472K8	7314150349494	1	376
1472K8BLACK	7314150349555	1	376
1472K8BLUE	7314150349647	1	376
1472K8GREY	7314150404018	1	376
1472K8RED	7314150349593	1	376
1472K8WHITE	7314150403721	1	376
1475K-ACSIDE	7314150419968	1	383
1475K6	7314150349654	1	381
1475K6BLACK	7314150349685	1	381
1475K6BLUE	7314150349760	1	381
1475K6RED	7314150349715	1	381
1475K7	7314150349661	1	381
1475K7BLACK	7314150349692	1	381
1475K7BLUE	7314150349814	1	381
1475K7RED	7314150349746	1	381
1475K8	7314150349678	1	381
1475K8BLACK	7314150349708	1	381
1475K8BLUE	7314150349821	1	381
1475K8RED	7314150349753	1	381
1475KXL-AC20BK	7314150353903	1	382
1475KXL12	7314150350223	1	380
1475KXL12BLACK	7314150350230	1	380
1475KXL12RED	7314150402731	1	380
1475KXL6	7314150349968	1	381
1475KXL6BLACK	7314150349999	1	381
1475KXL6BLUE	7314150350162	1	381
1475KXL6C	7314150350193	1	381
1475KXL6CCKB-FF5	7314150437467	1	376
1475KXL6CCKB-FF6	7314150437474	1	375
1475KXL6CBLACK	7314150350209	1	381
1475KXL6RED	7314150350124	1	381
1475KXL7	7314150349975	1	380
1475KXL7BLACK	7314150350070	1	380
1475KXL7BLUE	7314150350179	1	380
1475KXL7RED	7314150350148	1	380
1475KXL8	7314150349982	1	380
1475KXL8BLACK	7314150350094	1	380
1475KXL8BLUE	7314150350186	1	380
1475KXL8RED	7314150350155	1	380
1475KXXL-ACTSS	7314150459896	1	381
1475KXXL-ACTW	7314150465330	1	382
1475KXXL8CWTSS	7314150400157	1	380
1476KXXL7BK	7314150439935	1	380
1477K-AC10	7314150353163	1	379
1477K-AC12	7314150369195	1	377
1477K-AC13	7314150369218	1	377
1477K-AC14	7314150369225	1	378
1477K-AC15	7314150369249	1	378
1477K-AC16	7314150369256	1	378
1477K-AC17	7314150369270	1	378
1477K-AC18	7314150369287	1	378
1477K-AC19	7314150369676	1	378
1477K-AC20	7314150369683	1	378
1477K-AC21	7314150370412	1	378
1477K-AC22	7314150369706	1	378
1477K-AC24	7314150370429	1	379
1477K-AC25	7314150370436	1	379
1477K-AC26	7314150414864	1	379
1477K-AC30	7314150469949	1	379
1477K-ACTD	7314150370474	1	379
1477K-ACTP	7314150383764	1	379
1477K-ACTSS	7314150370450	1	379
1477K-ACTW	7314150370467	1	379
1477K6	7314150350391	1	376
1477K6BLACK	7314150351091	1	376
1477K6GREY	7314150351138	1	376
1477K6RED	7314150403653	1	376
1477K6WHITE	7314150358137	1	376
1477K7	7314150350407	1	376
1477K7BLACK	7314150351107	1	376
1477K7GREY	7314150351145	1	376
1477K7RED	7314150403660	1	376
1477K7WHITE	7314150358144	1	376
1477K8	7314150350414	1	376
1477K8BLACK	7314150351114	1	376
1477K8GREY	7314150351183	1	376
1477K8RED	7314150403677	1	376



1477K8WHITE	7314150358151	1	376
1477K9	7314150350940	1	376
1477K9BLACK	7314150351121	1	376
1477K9GREY	7314150351190	1	376
1477K9RED	7314150403684	1	376
1477K9WHITE	7314150403691	1	376
148-1	7314150367801	1	118
148-1/2	7314150367726	1	118
148-11/16	7314150367757	1	118
148-13	7314150367559	1	118
148-13/16	7314150367771	1	118
148-14	7314150367566	1	118
148-15	7314150367573	1	118
148-15/16	7314150367795	1	118
148-16	7314150367580	1	118
148-17	7314150367597	1	118
148-18	7314150367603	1	118
148-19	7314150367610	1	118
148-21	7314150367627	1	118
148-22	7314150367634	1	118
148-24	7314150367641	1	118
148-27	7314150367658	1	118
148-28	7314150367665	1	118
148-3/4	7314150367764	1	118
148-30	7314150367672	1	118
148-32	7314150367689	1	118
148-34	7314150367696	1	118
148-36	7314150367702	1	118
148-41	7314150367719	1	118
148-5/8	7314150367740	1	118
148-7/8	7314150367788	1	118
148-9/16	7314150367733	1	118
1482K4	7314150415779	1	377
1482K4BKW	7314150426126	1	377
1482K4BLACK	7314150415786	1	377
1482K4BLUE	7314150415793	1	377
1482K4GREY	7314150415809	1	377
1482K4RED	7314150415816	1	377
1482K4W	7314150425174	1	377
1482K4WHITE	7314150415823	1	377
1482K5W	7314150431274	1	377
1483CART	7314150273256	1	458
1483K2RB	7314150230013	1	458
1483K3RB	7314150230037	1	458
1483KHD3RB	7314150230099	1	458
1483KHD3RB-FF1	7314150233564	1	456
1483KHD3RB-FF2	7314150233571	1	456
1483KHD3RB-FF3	7314150233588	1	457
1483KHD3RB-FF4	7314150233595	1	457
1483KHD3RB-FF5	7314150233601	1	457
1483KHD3RB-FF7	7314150336050	1	457
1483KHD4RB	7314150230105	1	458
1484THD3RB	7314150265435	1	458
1485K4	7314150349838	1	381
1485K4BLACK	7314150349920	1	381
1485K4BLUE	7314150349944	1	381
1485K4RED	7314150349937	1	381
1485KXL4	7314150350247	1	381
1485KXL4BLACK	7314150350346	1	381
1485KXL4BLUE	7314150350360	1	381
1485KXL4RED	7314150350353	1	381
1487K4	7314150351206	1	376
1487K4BKW	7314150426133	1	376
1487K4BLACK	7314150351213	1	376
1487K4GREY	7314150351237	1	376
1487K4W	7314150425181	1	376
1495CD-AC1	7314150296965	1	453
1495CD60	7314150296927	1	450
1495CD60TS1	7314150325627	1	448
1495CD60W	7314150303656	1	451
1495CS-AC1	7314150296910	1	453
1495CS15	7314150296934	1	450
1495CS15BL	7314150326860	1	450
1495CS15TS1	7314150325610	1	448
1495CS18	7314150296941	1	450
1495CS18BL	7314150326891	1	450
1495CS18BLHK	7314150407620	1	450
1495CS18HK	7314150407613	1	450
1495CS18TS1	7314150325603	1	448
1495FWB097TD	7314150296675	1	456
1495FWB120TD	7314150296682	1	456
1495FWB120TS	7314150296668	1	456
1495K6CBKWB15TS	7314150368990	1	455
1495K6CBKWB15TW	7314150369034	1	455
1495K6CBKWB18TS	7314150369591	1	454
1495K6CBKWB18TW	7314150369638	1	455
1495K6CBLWB15TS	7314150369119	1	455
1495K6CBLWB15TW	7314150369232	1	455
1495K6CBLWB18TS	7314150369744	1	454
1495K6CBLWB18TW	7314150369782	1	455
1495K6CRDWB15TS	7314150368600	1	455
1495K6CRDWB15TW	7314150368655	1	455
1495K6CRDWB18TS	7314150369478	1	454
1495K6CRDWB18TW	7314150369515	1	455
1495K6CWB15TS	7314150368440	1	455
1495K6CWB15TW	7314150368501	1	455



1495K6CWB18TS	7314150369355	1	454
1495K6CWB18TW	7314150369393	1	455
1495K7CBKW15TS	7314150369003	1	455
1495K7CBKW15TW	7314150369041	1	455
1495K7CBKW18TS	7314150369607	1	454
1495K7CBKW18TW	7314150369645	1	455
1495K7CBLWB15TS	7314150369164	1	455
1495K7CBLWB15TW	7314150369263	1	455
1495K7CBLWB18TS	7314150369751	1	454
1495K7CBLWB18TW	7314150369799	1	455
1495K7CRDWB15TS	7314150368624	1	455
1495K7CRDWB15TW	7314150368662	1	455
1495K7CRDWB18TS	7314150369485	1	454
1495K7CRDWB18TW	7314150369522	1	455
1495K7CWB15TS	7314150368464	1	455
1495K7CWB15TW	7314150368518	1	455
1495K7CWB18TS	7314150369362	1	454
1495K7CWB18TW	7314150369409	1	455
1495K8CBKW15TS	7314150369010	1	455
1495K8CBKW15TW	7314150369058	1	455
1495K8CBKW18TS	7314150369614	1	454
1495K8CBKW18TW	7314150369652	1	455
1495K8CBLWB15TS	7314150369188	1	455
1495K8CBLWB15TW	7314150369294	1	455
1495K8CBLWB18TS	7314150369768	1	454
1495K8CBLWB18TW	7314150369805	1	455
1495K8CRDWB15TS	7314150368631	1	455
1495K8CRDWB15TW	7314150368693	1	455
1495K8CRDWB18TS	7314150369492	1	454
1495K8CRDWB18TW	7314150369539	1	455
1495K8CWB15TS	7314150368471	1	455
1495K8CWB15TW	7314150368525	1	455
1495K8CWB18TS	7314150370061	1	454
1495K8CWB18TW	7314150369416	1	455
1495KWB15TS	7314150338115	1	455
1495KWB15TW	7314150296613	1	455
1495KWB18TS	7314150338122	1	455
1495KWB18TW	7314150296620	1	455
1495TP-AC1	7314150297030	1	453
1495TP-AC10	7314150297207	1	453
1495TP-AC11	7314150297214	1	453
1495TP-AC12	7314150297221	1	453
1495TP-AC13	7314150297238	1	453
1495TP-AC2	7314150297122	1	453
1495TP-AC3	7314150297139	1	454
1495TP-AC4	7314150297146	1	454
1495TP-AC5	7314150297153	1	454
1495TP-AC6	7314150297160	1	454
1495TP-AC7	7314150297177	1	454
1495TP-AC8	7314150297184	1	454
1495TP-AC9	7314150297191	1	454
1495TP-ACHL20	7314150297047	1	454
1495TP-ACHL40	7314150297054	1	454
1495TP-ACHL65	7314150297061	1	454
1495TP-ACHL90	7314150297078	1	454
1495TP-ACHU20	7314150297085	1	454
1495TP-ACHU40	7314150297092	1	454
1495TP-ACHU65	7314150297108	1	454
1495TP-ACHU90	7314150297115	1	454
1495TP-AUTO-M1	7314150438266	1	451
1495TP-AUTO-M2	7314150438273	1	451
1495TP-AUTO-M3	7314150438280	1	451
1495TP-AUTO-M4	7314150438297	1	452
1495TP-AUTO-M5	7314150438303	1	452
1495TP-AUTO-M6	7314150438310	1	452
1495TP06	7314150296989	1	452
1495TP06GR	7314150326914	1	452
1495TP09	7314150438624	1	452
1495TP09-RAIL	7314150465705	1	453
1495TP12	7314150296996	1	452
1495TP12GR	7314150326921	1	452
1495TP15	7314150297009	1	452
1495TP18	7314150297016	1	452
1495TP18GR	7314150326945	1	452
1495WB-AC1	7314150296576	1	456
1495WB15-AC1	7314150296590	1	456
1495WB15TS	7314150296514	1	456
1495WB15TSBL	7314150326990	1	456
1495WB15TSBT	7314150407651	1	455
1495WB15TSRED	7314150327003	1	456
1495WB15TW	7314150296538	1	456
1495WB15TWGR	7314150327140	1	456
1495WB18-AC1	7314150296606	1	456
1495WB18TS	7314150296545	1	456
1495WB18TSBK	7314150327010	1	456
1495WB18TSBL	7314150327027	1	456
1495WB18TSBLBT	7314150407644	1	455
1495WB18TSBT	7314150407637	1	455
1495WB18TSRED	7314150327034	1	456
1495WB18TW	7314150296569	1	456
1495WB18TWGR	7314150327164	1	456
1496MB2	7314150273478	1	462
1496MB3	7314150273485	1	462
1496MB4	7314150273492	1	462
1496MB5	7314150273508	1	462
1497MBF350	7314150321391	1	461



1497MBF550	7314150321407	1	461
1497MBF750	7314150321414	1	461
1497MBW	7314150330164	1	461
14A-32	7314150368228	1	119
14A-9	7314150368211	1	119
14F-1/2	7314150366200	1	116
14F-3/4	7314150366217	1	116
14P-1/2	7314150366064	1	116
14Q-1/2	7314150366026	1	116
14R-1/2	7314150365920	1	115
14R-3/4	7314150365937	1	115
14T-1/2	7314150366125	1	116
14T-3/4	7314150366132	1	116
14W	7314150357031	1	119
1519 D	7314150032747	3	237
1519-9	7314150026074	1	237
1520 D	7311518278922	5	233
1520 G	7311518266516	5	233
1520 G IP	7314150437740	5	233
1535	7314150214808	1	545
1537	7314150214822	1	545
1544	7311518276560	1	545
1546	7314150214792	1	545
1547	7311518276577	20	545
158-N	7311518277239	12	242
158-NB	7311518277246	12	244
1610	7314150404186	1	266
1610-NUT	7314150409594	1	266
1620	7314150404193	1	266
1620-NUT	7314150409754	1	266
166-6-16-2.5-12	7311518021979	12	26
166-6-16-2.5-2	7311518209698	5	26
167-1	7314150419067	1	120
167-1.1/16	7314150419074	1	120
167-1.1/4	7314150419104	1	120
167-1.1/8	7314150419081	1	120
167-1.3/16	7314150419098	1	120
167-1/2	7314150418930	1	120
167-10	7314150418657	1	120
167-11	7314150418664	1	120
167-11/16	7314150419364	1	120
167-12	7314150418671	1	120
167-13	7314150418688	1	120
167-13/16	7314150419036	1	120
167-14	7314150418695	1	120
167-15	7314150418701	1	120
167-15/16	7314150419050	1	120
167-16	7314150418718	1	120
167-17	7314150418725	1	120
167-18	7314150418732	1	120
167-19	7314150418749	1	120
167-20	7314150418763	1	120
167-21	7314150418770	1	120
167-22	7314150418787	1	120
167-23	7314150418794	1	120
167-24	7314150418800	1	120
167-25	7314150418817	1	120
167-26	7314150418824	1	120
167-27	7314150418831	1	120
167-28	7314150418848	1	120
167-3/4	7314150419029	1	120
167-3/8	7314150418909	1	120
167-30	7314150418855	1	120
167-32	7314150418862	1	120
167-36	7314150418886	1	120
167-5/16	7314150418893	1	120
167-5/8	7314150419012	1	120
167-7	7314150418619	1	120
167-7/16	7314150418916	1	120
167-7/8	7314150419043	1	120
167-8	7314150418626	1	120
167-8-21-3.2-12	7311518021986	12	26
167-9	7314150418640	1	120
167-9/16	7314150419005	1	120
168-1	7314150419562	1	121
168-1.1/16	7314150419579	1	121
168-1.3/16	7314150419586	1	121
168-1/2	7314150419487	1	121
168-10	7314150419272	1	121
168-11	7314150419289	1	121
168-11/16	7314150419517	1	121
168-12	7314150419296	1	120
168-13	7314150419302	1	121
168-13/16	7314150419531	1	121
168-14	7314150419319	1	121
168-15	7314150419326	1	121
168-15/16	7314150419555	1	121
168-16	7314150419333	1	121
168-17	7314150419340	1	121
168-18	7314150419357	1	121
168-19	7314150419371	1	121
168-20	7314150419388	1	121
168-21	7314150419395	1	121
168-22	7314150419401	1	121
168-23	7314150419418	1	121
168-24	7314150419425	1	121





168-26	7314150419432	1	121
168-27	7314150419449	1	121
168-3/4	7314150419524	1	121
168-3/8	7314150419463	1	121
168-5/16	7314150419456	1	121
168-5/8	7314150419500	1	121
168-6-3.2-1P	7311518152338	12	26
168-6-3.2-3P	7311518152413	12	27
168-6-3.5-1P	7311518152345	12	26
168-6-3.5-3P	7311518152420	12	27
168-7	7314150419241	1	120
168-7/16	7314150419470	1	121
168-7/8	7314150419548	1	121
168-8	7314150419258	1	120
168-8-4.0-1P	7311518152352	12	26
168-8-4.0-3P	7311518152437	12	27
168-8-4.0-6	7311518217419	6	27
168-8-4.5-1P	7311518152369	12	26
168-8-4.5-3P	7311518152444	12	27
168-8-4.5-6	7311518217426	6	27
168-8-4.8-1P	7311518152376	12	26
168-8-4.8-3P	7311518152451	12	27
168-8-4.8-6	7311518217433	6	27
168-8-5.2-1P	7311518152383	12	26
168-8-5.2-3P	7311518152468	12	27
168-8-5.2-6	7311518217440	6	27
168-8-5.5-1P	7311518152390	12	26
168-8-5.5-3P	7311518152475	12	27
168-8-5.5-6	7311518217457	6	27
168-8-6.3-1P	7311518152406	12	26
168-8-6.3-3P	7311518152482	12	27
168-9	7314150419265	1	120
168-9/16	7314150419494	1	121
168-COMBI-4.0	7311518209667	10	27
168-COMBI-4.0-6922	7311518209612	10	27
168-COMBI-4.5	7314150272860	10	27
168-COMBI-4.8	7311518209674	10	27
168-COMBI-4.8-6920	7311518209643	10	27
168-COMBI-5.5	7311518209681	10	27
168-COMBI-5.5-6924	7311518209650	10	27
169-10	7314150419630	1	121
169-11	7314150419647	1	121
169-12	7314150419654	1	121
169-13	7314150419661	1	121
169-14	7314150419678	1	121
169-15	7314150419715	1	121
169-16	7314150419722	1	121
169-17	7314150419739	1	121
169-18	7314150419746	1	121
169-19	7314150419753	1	121
169-20	7314150419760	1	121
169-21	7314150419777	1	121
169-22	7314150419784	1	121
169-23	7314150419791	1	121
169-24	7314150419807	1	121
169-27	7314150419814	1	121
169-7	7314150419609	1	121
169-8	7314150419616	1	121
169-9	7314150419623	1	121
16F-1/2	7314150418565	1	119
16F-1/4	7314150418541	1	119
16F-3/8	7314150418558	1	119
16R-1/2	7314150418602	1	119
16R-1/4	7314150418589	1	119
16R-3/8	7314150418596	1	119
1931M-10	7314151049256	5	49
1931M-11	7314151049263	5	49
1931M-12	7314151049270	5	49
1931M-13	7314151049287	5	49
1931M-14	7314151049294	5	49
1931M-17	7314151049324	5	49
1931M-4	7314151049171	5	49
1931M-4.5	7314151049188	5	49
1931M-5	7314151049195	5	49
1931M-5.5	7314151049201	5	49
1931M-6	7314151049218	5	49
1931M-7	7314151049225	5	49
1931M-8	7314151049232	5	49
1931M-9	7314151049249	5	49
1931M/10T	7314151049409	1	50
1931Z-1/2	7314151049775	5	49
1931Z-1/4	7314151049713	5	49
1931Z-1/8	7314150371563	5	49
1931Z-11/32	7314151049744	5	49
1931Z-11/32-3/8	7314150371624	5	49
1931Z-13/64	7314151049683	5	49
1931Z-15/64-1/4	7314150371570	5	49
1931Z-3/16	7314151049676	5	49
1931Z-3/8	7314151049751	5	49
1931Z-5/16	7314151049737	5	49
1931Z-5/32	7314151049669	5	49
1931Z-5/8	7314151049799	5	49
1931Z-7/16	7314151049768	5	49
1931Z-7/32	7314151049690	5	49
1931Z-9/16	7314151049782	5	49
1931Z-9/32	7314151049720	5	49



1931Z-9/32-5/16	7314150371600	5	49
1931Z/12T	7314150107674	1	50
1933M/6T	7314151821654	1	50
1936M-10-11	7314151051402	25	58
1936M-10-13	7314151344146	25	58
1936M-12-13	7314151051419	25	58
1936M-13-17	7314151830144	20	58
1936M-14-15	7314151051426	20	58
1936M-14-17	7314151051129	15	58
1936M-16-17	7314151051433	15	58
1936M-17-19	7314151051136	10	58
1936M-18-19	7314151051440	10	58
1936M-19-22	7314151051150	8	58
1936M-20-22	7314151830151	8	58
1936M-21-23	7314151830168	8	58
1936M-22-24	7314151830175	5	58
1936M-24-26	7314151830182	5	58
1936M-24-27	7314151051181	5	58
1936M-25-28	7314151830199	5	58
1936M-30-32	7314151051501	1	58
1936M-30-34	7314151838577	4	58
1936M-36-41	7314151830205	4	58
1936M-46-50	7314151830212	2	58
1936M-6-7	7314151051389	50	58
1936M-8-10	7314151830137	30	58
1936M-8-9	7314151051396	5	58
1936M/12	7314151830250	1	58
1936M/7	7314151830243	1	58
1943M-11-13	7314151052829	1	53
1943M-13-15	7314151804732	1	53
1943M-13-17	7314151804749	1	53
1943M-14-17	7314151052843	1	53
1943M-15-17	7314151052850	1	53
1943M-19-22	7314151052867	1	53
1943Z-11/16-13/16	7314150355174	1	53
1943Z-5/16-3/8	7314150355136	1	53
1943Z-5/8-3/4	7314150355167	1	53
1943Z-7/16-1/2	7314150355143	1	53
1943Z-9/16-5/8	7314150355150	1	53
1945W/12	7314150352289	6	316
1945W/14	7314150352265	8	316
1945W/38	7314150352272	6	316
1949M-10-11	7314151055394	1	54
1949M-10-12	7314151055400	1	54
1949M-12-13	7314151055417	1	54
1949M-12-14	7314151055424	1	54
1949M-14-15	7314151304546	1	54
1949M-14-17	7314151055448	1	54
1949M-17-19	7314151055455	1	54
1949M-19-22	7314151055462	1	54
1949M-22-24	7314151304553	1	54
1949M-24-27	7314151055479	1	54
1949M-30-32	7314151304577	1	54
1949M-8-9	7314151304539	1	54
1949Z-1-1.1/8	7314151055547	1	54
1949Z-1/2-9/16	7314151055509	1	54
1949Z-3/4-7/8	7314151055530	1	54
1949Z-3/8-7/16	7314151055486	1	54
1949Z-5/8-3/4	7314151055523	1	54
1950MZ-3/8	7314150130207	1	55
1952M-10	7314151057213	10	43
1952M-11	7314151057220	10	43
1952M-12	7314151057237	10	43
1952M-13	7314151057244	10	43
1952M-14	7314151057251	10	43
1952M-15	7314151057268	10	43
1952M-16	7314151057275	10	43
1952M-17	7314151057282	10	43
1952M-18	7314151057299	10	43
1952M-19	7314151057305	10	43
1952M-20	7314151057312	10	43
1952M-21	7314151057329	10	43
1952M-22	7314151057336	5	43
1952M-23	7314151057343	5	43
1952M-24	7314151057350	5	43
1952M-25	7314151057367	5	43
1952M-26	7314151057374	5	43
1952M-27	7314151057381	5	43
1952M-28	7314151057398	1	43
1952M-29	7314151325763	1	43
1952M-30	7314151057404	1	43
1952M-32	7314151057411	1	43
1952M-34	7314151838553	1	43
1952M-36	7314151057428	1	43
1952M-41	7314151057435	1	43
1952M-46	7314151840105	1	43
1952M-50	7314151840112	1	43
1952M-55	7314151840129	1	43
1952M-6	7314151057176	10	43
1952M-60	7314151840136	1	43
1952M-65	7314150135226	1	43
1952M-7	7314151057183	10	43
1952M-70	7314150135301	1	43
1952M-75	7314150135325	1	43
1952M-8	7314151057190	10	43
1952M-80	7314150135509	1	43



1952M-9	7314151057206	10	43
1952M/10	7314151057688	1	44
1952M/14T	7314151057695	1	44
1952M/17T	7314151057473	1	44
1952M/26T	7314151057701	1	44
1952M/7T	7314151806637	1	44
1952M/SH12	7314153013330	1	44
1952M/SH6	7314153013286	1	44
1952Z-1	7314151057602	1	43
1952Z-1.1/16	7314151057619	1	43
1952Z-1.1/2	7314151057756	1	43
1952Z-1.1/4	7314151057633	1	43
1952Z-1.1/8	7314151057626	1	43
1952Z-1.3/8	7314151057732	1	43
1952Z-1.5/16	7314151057718	1	43
1952Z-1.5/8	7314151057763	1	43
1952Z-1.7/16	7314151057749	1	43
1952Z-1/2	7314151057527	5	43
1952Z-1/4	7314151057480	5	43
1952Z-11/16	7314151057558	5	43
1952Z-11/32	7314150111046	5	43
1952Z-13/16	7314151057572	5	43
1952Z-15/16	7314151057596	5	43
1952Z-3/4	7314151057565	5	43
1952Z-3/8	7314151057503	5	43
1952Z-5/16	7314151057497	5	43
1952Z-5/8	7314151057541	5	43
1952Z-7/16	7314151057510	5	43
1952Z-7/8	7314151057589	5	43
1952Z-9/16	7314151057534	5	43
1952Z/11T	7314151057725	1	45
1976TORX-T10	7314150123438	5	228
1976TORX-T15	7314150123452	5	228
1976TORX-T20	7314150123469	5	228
1976TORX-T25	7314150123476	5	228
1976TORX-T27	7314150123490	5	228
1976TORX-T30	7314150123506	5	228
1976TORX-T40	7314150123513	5	228
1976TORX-T6	7314150122240	5	228
1976TORX-T7	7314150123384	5	228
1976TORX-T8	7314150123391	5	228
1976TORX-T9	7314150123414	5	228
1976TORX/5T	7314150126927	1	228
1986TORX-T10	7314150123537	5	228
1986TORX-T15	7314150123544	5	228
1986TORX-T20	7314150123551	5	228
1986TORX-T25	7314150123568	5	228
1986TORX-T27	7314150123575	5	228
1986TORX-T30	7314150123582	5	228
1986TORX-T40	7314150123599	5	228
1986TORX-T9	7314150122233	5	228
1986TORX/7T	7314150123735	1	228
1995LM-1.5	7314150122172	10	224
1995LM-10	7314150123254	10	224
1995LM-12	7314150123261	10	224
1995LM-14	7314150123278	10	224
1995LM-2	7314150122189	10	224
1995LM-2.5	7314150123162	10	224
1995LM-3	7314150123179	10	224
1995LM-4	7314150123186	10	224
1995LM-5	7314150123209	10	224
1995LM-6	7314150123216	10	224
1995LM-7	7314150123223	10	224
1995LM-8	7314150123230	10	224
1995LM-9	7314150123247	10	224
1995M-0.9	7314150216291	10	223
1995M-1.5	7314150122158	10	223
1995M-10	7314150122912	10	223
1995M-12	7314150122943	10	223
1995M-14	7314150122967	10	223
1995M-17	7314150122974	10	223
1995M-19	7314150122981	10	223
1995M-2	7314150122745	10	223
1995M-2.5	7314150122752	10	223
1995M-22	7314150122998	10	223
1995M-3	7314150122769	10	223
1995M-4	7314150122776	10	223
1995M-5	7314150122790	10	223
1995M-6	7314150122813	10	223
1995M-7	7314150122837	10	223
1995M-8	7314150122851	10	223
1995M-9	7314150122875	10	223
1995M/10T	7314150123643	1	223
1995M/11T	7314150123650	1	223
1995M/15T	7314150123667	1	223
1995M/6T	7314150123629	1	223
1995M/8T	7314150123636	1	223
1995TORX-T10	7314150123308	5	226
1995TORX-T15	7314150123322	5	226
1995TORX-T20	7314150123339	5	226
1995TORX-T25	7314150123346	5	226
1995TORX-T27	7314150123353	5	226
1995TORX-T30	7314150123360	5	226
1995TORX-T40	7314150123377	5	226
1995TORX-T45	7314150123407	5	226
1995TORX-T50	7314150123421	5	226



1995TORX-T55	7314150216963	5	226
1995TORX-T6	7314150122196	5	226
1995TORX-T60	7314150216970	5	226
1995TORX-T7	7314150123285	5	226
1995TORX-T8	7314150123292	5	226
1995TORX-T9	7314150122219	5	226
1995TORX/11T	7314150123742	1	227
1995TORX/13T	7314150123759	1	227
1995TORX/4T	7314150123674	1	226
1995TORX/7T	7314150123711	1	226
1995Z-1/16	7314150122165	10	223
1995Z-1/2	7314150123117	10	223
1995Z-1/4	7314150123070	10	223
1995Z-1/8	7314150123025	10	223
1995Z-3/16	7314150123056	10	223
1995Z-3/32	7314150123018	10	223
1995Z-3/4	7314150123155	10	223
1995Z-3/8	7314150123094	10	223
1995Z-5/16	7314150123087	10	223
1995Z-5/32	7314150123049	10	223
1995Z-5/64	7314150123001	10	223
1995Z-5/8	7314150123131	10	223
1995Z-7/16	7314150123100	10	223
1995Z-7/32	7314150123063	10	223
1995Z/10T	7314150215980	1	224
1995Z/12T	7314150215997	1	224
1996M-1.5	7314150122202	10	225
1996M-10	7314150122721	10	225
1996M-12	7314150122738	5	225
1996M-2	7314150122653	10	225
1996M-2.5	7314150122660	10	225
1996M-3	7314150122677	10	225
1996M-4	7314150122684	10	225
1996M-5	7314150122691	10	225
1996M-6	7314150122707	10	225
1996M-8	7314150122714	10	225
1996TORX-T10	7314150122783	5	227
1996TORX-T15	7314150122806	5	227
1996TORX-T20	7314150122820	5	227
1996TORX-T25	7314150122844	5	227
1996TORX-T27	7314150122868	5	227
1996TORX-T30	7314150122882	5	227
1996TORX-T40	7314150122899	5	227
1996TORX-T45	7314150122905	5	227
1996TORX-T50	7314150122929	5	227
1996TORX-T9	7314150122226	5	227
1996TORX/5T	7314150123698	1	227
1998M-1.5	7314150185719	10	222
1998M-10	7314150185801	10	222
1998M-12	7314150185818	5	222
1998M-14	7314150185825	1	222
1998M-17	7314150185832	1	222
1998M-19	7314150185849	1	222
1998M-2	7314150185726	10	222
1998M-2.5	7314150185733	10	222
1998M-22	7314150185856	1	222
1998M-3	7314150185740	10	222
1998M-4	7314150185757	10	222
1998M-5	7314150185764	10	222
1998M-6	7314150185863	10	222
1998M-7	7314150185771	10	222
1998M-8	7314150185788	10	222
1998M-9	7314150185795	5	222
1998M/10T	7314150186228	1	222
1998M/11T	7314150186235	1	222
1998M/15T	7314150186242	1	222
1998M/6T	7314150186204	1	222
1998M/8R	7314150186266	1	222
1998M/8T	7314150186211	1	222
1999M/7H	7314151801076	1	222
1999MV-10	7314150121496	3	502
1999MV-12	7314150121502	3	502
1999MV-3	7314150121427	5	502
1999MV-4	7314150121434	5	502
1999MV-5	7314150121441	5	502
1999MV-6	7314150121458	5	502
1999MV-7	7314150121465	5	502
1999MV-8	7314150121472	5	502
1999MV-9	7314150121489	5	502
1RM-10	7314153000576	1	45
1RM-11	7314153000583	1	45
1RM-12	7314153000590	1	45
1RM-13	7314153000606	1	45
1RM-14	7314153000613	1	45
1RM-15	7314153000620	1	45
1RM-16	7314153000637	1	45
1RM-17	7314153000644	1	45
1RM-18	7314153000651	1	45
1RM-19	7314153000668	1	45
1RM-21	7314150214495	1	45
1RM-22	73141530005915	1	45
1RM-24	73141530005922	1	45
1RM-27	7314153014177	1	45
1RM-30	7314153014184	1	45
1RM-32	7314153014191	1	45
1RM-6	7314153014146	1	45





2629G-200	7314150446957	5	240
2629G-200IP	7314150446988	5	240
2630DC-160IP	7314150446896	5	240
2630DC-180IP	7314150446902	5	240
2630DC-200IP	7314150446919	5	240
2630GC-160IP	7314150180165	5	240
2630GC-180IP	7314150180172	5	240
2630GC-200IP	7314150180189	5	240
2630SC-180	7314150446926	3	499
2632	7314151065706	1	370
2633/S4	7311518276942	12	535
2633HD/S6	7314150205783	1	315
2633HD1	7314150230464	1	315
2633HD2	7314150230471	1	315
2633HD3	7314150230488	1	315
2633HD4	7314150230495	1	315
2633HD5	7314150230501	1	315
2633HD6	7314150230518	1	315
2633L/S4	7311518276959	12	535
2635	7311518276348	1	609
2640D-160	7314150123766	10	240
2640D-180	7314150123773	5	240
2640D-200	7314150123797	5	240
2646	7314151304638	1	235
2646 A	7314151304645	1	235
2646 AK	7314151396619	1	235
2646 K	7314151495862	1	235
2646 M	7314151487928	1	235
2646 MF	7314151573683	1	245
2646 MS	7314151573768	1	246
2646 R	7314151304706	1	235
2646 RA	7314151834838	1	235
2646 RK	7314151496678	1	235
2648	7314151304713	1	235
2648 A	7314151304720	1	235
2649	7314150058013	1	235
2650	7314151065829	1	248
2650 B	7314151065843	1	248
2656	7314151304737	1	237
2656 R	7314151473976	1	244
2656 S	7314150058044	1	242
2666	7314150058006	1	235
2666 FK	7314151066079	1	235
2674 NB	7314151066321	1	234
2674 NVDE	7314151498535	1	499
2676 B	7314151066390	1	235
2678 B	7314151066468	1	235
2678 G-160	7314150116157	5	241
2678 G-180	7314150116164	5	241
2678 G-200	7314150116171	5	241
2678V-160	7314150126835	2	499
2678V-180	7314150126842	2	499
2678V-200	7314150126859	2	499
268	7311518017538	5	557
2681	7311518276706	12	263
2681-1	7314150116980	1	264
2688D-250	7314150123520	3	240
2690	7314150411108	10	263
26S-1216	7314151830236	8	59
26S-16	7314150345588	5	59
26S-610	7314151830229	10	59
2700-22-XT7-HP	7311518191672	4	565
2700-24-XT7-HP	7311518191665	4	565
2704A	7314151066963	1	579
2705R	7314151821470	1	579
2720	7314150179701	1	238
2720-SH	7314150179718	1	238
2744	7314151809096	6	579
277-30	7314150367184	1	117
277-32	7314150367191	1	117
277-34	7314150367207	1	117
277-36	7314150367214	1	117
277-41	7314150367221	1	117
277-46	7314150367238	1	117
277-50	7314150367245	1	117
277-55	7314150367252	1	117
277-60	7314150367269	1	117
278-30	7314150367924	1	118
278-32	7314150367931	1	118
278-34	7314150367948	1	118
278-36	7314150367955	1	118
278-41	7314150367962	1	118
278-46	7314150367979	1	118
278-50	7314150367986	1	118
278-55	7314150367993	1	118
278-60	7314150368006	1	118
2784-2.5	7314150215607	1	214
2784-3.5	7314150215614	1	214
2784-4.5	7314150215621	1	214
2787 F	7314151474270	1	236
2787 G	7314150058020	1	236
27A-24	7314150368259	1	119
27F-1	7314150366248	1	116
27M-10-11	7314150180523	10	58
27M-12-13	7314150180547	10	58
27M-13-17	7314150180790	10	58



27M-14-15	7314150180554	10	58
27M-16-17	7314150180561	10	58
27M-16-18	7314150180806	10	58
27M-18-19	7314150180578	10	58
27M-20-22	7314150180585	10	58
27M-21-23	7314150180592	5	58
27M-21-24	7314150180813	5	58
27M-24-26	7314150180608	5	58
27M-24-27	7314150180820	5	58
27M-25-28	7314150180622	5	58
27M-27-29	7314150180639	5	58
27M-30-32	7314150180646	5	58
27M-6-7	7314150180509	10	58
27M-8-9	7314150180516	10	58
27M/10	7314150180677	1	59
27M/12	7314150180684	1	59
27M/12T	7314150180783	1	58
27M/6	7314150180653	1	58
27M/8	7314150180660	1	59
27M/8T	7314150180776	1	58
27R-1	7314150365968	1	115
27T-1	7314150366163	1	116
28-29/S4	7314150179688	1	251
2800 N	7314151318338	1	239
2800-140	7314150121632	3	249
2800-150	7314150034567	3	249
2800-180	7314150034581	3	249
2800-225	7314150034604	3	249
2800-300	7314150122622	1	249
2801 N	7314151318352	1	239
2804	7314151692698	1	238
2805-280	7314151826123	1	238
2820EF1	7314150122042	12	585
2820EF2	7314150122059	8	586
2820EF3	7314150122066	1	586
2820EF4	7314150122073	1	586
2820EK	7314150122035	6	585
2820EK-01	7314150270743	12	585
2820VBC	7314150121917	1	499
2820VDE	7314151605476	10	503
2820VFP	7314150121922	1	503
2820VG05	7314150121953	1	503
2820VG10	7314150121960	1	503
2820VGCOT	7314150121977	1	503
2820VHELP	7314150121908	1	503
2820VM	7314150121946	1	503
2820VMP	7314150121885	2	502
2820VPC	7314150121892	2	503
2820VTEE	7314150121939	1	503
2855	7314151825805	1	264
2855 D	7314151822569	1	264
2856-10	7314150437214	1	264
2856-8	7314150437207	1	264
2890-125	7314150122639	3	249
2890-140	7314150034550	3	249
2890-180	7314150034574	3	249
2890-210	7314150034598	3	249
2890-300	7314150122646	1	249
28M-10	7314151834678	5	56
28M-11	7314151834685	5	56
28M-12	7314151834692	5	56
28M-13	7314151834708	5	56
28M-14	7314151834715	5	56
28M-15	7314151834722	5	56
28M-16	7314151834739	5	56
28M-17	7314151834746	5	56
28M-18	7314151834753	3	56
28M-19	7314151834760	3	56
28M-20	7314150122561	3	56
28M-21	7314151834777	3	56
28M-22	7314151834784	3	56
28M-23	7314150122578	3	56
28M-24	7314151834791	3	56
28M-25	7314150122585	3	56
28M-26	7314150122592	3	56
28M-27	7314151834807	3	56
28M-28	7314150122608	1	56
28M-29	7314150122615	1	56
28M-30	7314151834814	1	56
28M-32	7314151834821	1	56
28M-6	7314151834630	5	56
28M-7	7314151834647	5	56
28M-8	7314151834654	5	56
28M-9	7314151834661	5	56
28M/11	7314151838126	1	57
28M/12	7314151838133	1	57
28M/15	7314151838140	1	57
28M/8	7314151838119	1	57
28MV-10	7314150121298	2	501
28MV-11	7314150121304	2	501
28MV-12	7314150121311	2	501
28MV-13	7314150121328	2	501
28MV-14	7314150121335	2	501
28MV-15	7314150121342	2	501
28MV-16	7314150121359	2	501
28MV-17	7314150121366	2	501



28MV-18



28MV-18	7314150121373	2	501
28MV-19	7314150121380	2	501
28MV-20	7314150121397	2	501
28MV-21	7314150121403	2	501
28MV-22	7314150121410	2	501
28MV-8	7314150121274	2	501
28MV-9	7314150121281	2	501
29-B	7311518277703	1	328
2900-140	7314150121045	3	250
2900-150	7314150034499	3	250
2900-180	7314150034512	3	250
2900-215	7314150034536	3	250
2900-300	7314150121076	1	250
2928-1	7314150056583	1	250
2928-160	7314150056514	1	250
2928-2	7314150056590	1	250
2928-200	7314150056521	1	250
2928-250	7314150056538	1	250
2928-3	7314150056606	1	250
2928-4	7314150056613	1	250
2949-190IP	7314150123926	1	262
2949-200IP	7314150123940	1	262
2949-240IP	7314150123957	1	262
2949-250IP	7314150123971	1	262
2949-L075	7314150440559	1	263
2949-L120	7314150440566	1	263
2949-L200	7314150440573	1	263
2950-250	7314150124039	1	261
2951-140	7314150124084	1	259
2951-180	7314150102204	1	259
2951-250	7314150102211	1	259
2951-300	7314150102228	1	259
2951-S05	7314150447299	1	262
2951-S07	7314150447305	1	262
2951-S10	7314150447312	1	262
2951-S12	7314150447329	1	262
2952-165	7314150103836	1	260
2952-235	7314150103843	1	260
2953-140	7314150124046	1	259
2953-200	7314150124053	1	259
2953-250	7314150124060	1	259
2953-300	7314150124077	1	259
2955-250	7314150102235	1	260
2956-290	7314150413690	1	261
2957-250	7314150102259	1	260
2958-140	7314150124107	1	259
2958-200	7314150124114	1	259
2958-250	7314150102242	1	259
296	7311518034146	1	567
2960-280	7314150412808	1	261
2962-8-150	7314150412815	1	261
2962-8-230	7314150413706	1	261
2962-8-300	7314150413713	1	261
2963-280	7314150102280	1	261
2963-450	7314150124138	1	261
2963-630	7314150124145	1	261
2964-160	7314150124183	1	261
2964-280	7314150102297	1	261
2964-450	7314150124190	1	261
2964-600	7314150124206	1	261
2965-200	7314150124152	1	262
2965-280	7314150102266	1	262
2966-280	7314150102273	1	262
2967-180	7314150102396	1	260
2968-190	7314150124091	1	259
2968-235	7314150103850	1	259
2970G-200	7314150134946	5	241
2971G-250	7314150117154	5	248
2979 D-180	7314150034246	5	246
2990-125	7314150121250	3	250
2990-140	7314150034482	3	250
2990-180	7314150034505	3	250
2990-200	7314150034529	3	250
2990-300	7314150121267	1	250
2997-250	7314150124237	1	262
2997-300	7314150124244	5	262
2998-250	7314150124213	1	260
2998-SHN	7314150447275	1	260
2999-250	7314150124169	1	260
2999-SHN	7314150447282	1	260
29M-10	7314150122318	5	57
29M-11	7314150122325	5	57
29M-12	7314150122332	5	57
29M-13	7314150122349	5	57
29M-14	7314150122356	5	57
29M-15	7314150122363	5	57
29M-16	7314150122370	5	57
29M-17	7314150122387	5	57
29M-18	7314150122394	3	57
29M-19	7314150122400	3	57
29M-20	7314150122417	3	57
29M-21	7314150122424	3	57
29M-22	7314150122431	3	57
29M-23	7314150122448	3	57
29M-24	7314150122455	3	57
29M-25	7314150122462	3	57



29M-26	7314150122479	3	57
29M-27	7314150122486	3	57
29M-28	7314150122493	1	57
29M-29	7314150122509	1	57
29M-30	7314150122516	1	57
29M-32	7314150122523	1	57
29M-6	7314150122271	5	57
29M-7	7314150122288	5	57
29M-8	7314150122295	5	57
29M-9	7314150122301	5	57
29M/10	7314150122547	1	57
29M/14	7314150122554	1	57
29M/8	7314150122530	1	57
2M-10-11	7314151001223	5	52
2M-10-13	7314151001513	5	52
2M-12-13	7314151001230	5	52
2M-13-17	7314151343972	5	52
2M-14-15	7314151001247	5	52
2M-16-17	7314151001254	5	52
2M-16-18	7314151001575	5	52
2M-17-19	7314151000844	5	52
2M-18-19	7314151001261	5	52
2M-19-22	7314151000868	5	52
2M-20-22	7314151001278	5	52
2M-21-23	7314151001285	5	52
2M-22-24	7314151001612	5	52
2M-24-26	7314151001292	5	52
2M-24-27	7314151000899	5	52
2M-25-28	7314151001308	5	52
2M-27-29	7314150205332	5	52
2M-27-30	7314151001636	5	52
2M-27-32	7314151001322	5	52
2M-30-32	7314151000929	5	52
2M-32-36	7314151001667	1	52
2M-36-41	7314151001681	1	52
2M-41-46	7314151001704	1	52
2M-46-50	7314151001711	1	52
2M-6-7	7314151001209	5	52
2M-8-10	7314151001506	5	52
2M-8-9	7314151001216	5	52
2M/10T	7314150212996	1	52
2M/12T	7314151001414	1	53
2M/8T	7314151001391	1	52
2M/S8	7314151827335	1	52
2MV-10	7314150121113	5	501
2MV-11	7314150121120	5	501
2MV-12	7314150121137	5	501
2MV-13	7314150121144	5	501
2MV-14	7314150121151	5	501
2MV-15	7314150121168	5	501
2MV-16	7314150121175	5	501
2MV-17	7314150121182	3	501
2MV-18	7314150121199	3	501
2MV-19	7314150121205	3	501
2MV-21	7314150121212	3	501
2MV-22	7314150121229	3	501
2MV-23	7314150121236	3	501
2MV-24	7314150121243	3	501
2MV-6	7314150121069	5	501
2MV-7	7314150121083	5	501
2MV-8	7314150121090	5	501
2MV-9	7314150121106	5	501
2Z-1-1.1/8	7314151001827	1	52
2Z-1.1/16-1.1/4	7314151001834	1	52
2Z-1/2-9/16	7314151001445	1	52
2Z-1/4-5/16	7314151001421	1	52
2Z-13/16-7/8	7314151001797	1	52
2Z-15/16-1	7314151001810	1	52
2Z-3/4-7/8	7314151001773	1	52
2Z-3/8-7/16	7314151001438	1	52
2Z-5/16-3/8	7314151001728	1	52
2Z-5/8-11/16	7314151001452	1	52
2Z-9/16-5/8	7314151001735	1	52
2Z/7T	7314150217373	1	53
3-24-51	7315962500028	5	633
3-330-12-1-0	7311518020712	5	31
3-330-12-2-0	7311518020729	5	31
3-330-14-1-0	7311518020736	5	31
3-330-14-2-0	7311518020743	5	31
3-331-14-1-0	7311518020750	5	31
300-14-F15/16-HP	7311518005955	4	561
301	7311518001384	50	567
301-16	7314150456048	12	269
301-22	7311518293673	12	269
302	7311518013349	30	566
302-15-95	7314150486632	100	269
302-35	7311518293680	6	269
302-511W-12P	7311518207786	1	567
302-51W-12P	7311518013356	1	567
302-53W-12P	7311518013363	1	567
302-55W-12P	7311518013370	1	567
302-57W-12P	7311518013387	1	567
302-59W-12P	7311518207779	1	567
302-6X4P	7311518017590	1	567
302-71M-12P	7311518013394	1	567
302-73M-12P	7311518013400	1	567

302-75M-12P	7311518013417	1	567
302-76-95	7314150188345	1	269
302-76N	7314150456307	6	269
302-77M-12P	7311518207793	1	567
302-81S-12P	7311518013677	1	567
302-83S-12P	7311518013684	1	567
302-85S-12P	7311518207809	1	567
302-95-SET	7314150456321	1	269
303-5P	7311518031435	10	567
304	7311518265533	10	556
3045/1VDE	7314151783815	1	504
3045V-1	7314150128785	1	504
3045V-2	7314150128792	1	504
3046-OP	7311518276980	12	361
3046-REF	7311518276966	1	309
3049-2	7314151848118	1	464
306	7311518265540	10	556
306-10	7314150120246	1	268
306-12	7314150120253	1	268
306-15	7311518297107	12	268
306-15-95	7311518297329	1	269
306-22	7311518297114	12	268
306601500	8413345098700	5	588
306602000	8413345098717	5	588
306603000	8413345217033	5	588
306604000	8413345217095	5	588
306703000	8413345217194	5	588
306704000	8413345098755	5	588
306705000	8413345098762	5	588
306706000	8413345098779	5	588
306708000	8413345098786	5	588
306710000	8413345098793	5	588
306712000	8413345123334	2	588
306715000	8413345123341	2	588
306803000	8413345098809	5	588
306804000	8413345098816	5	588
306805000	8413345098823	2	588
306806000	8413345098830	2	588
306808000	8413345098847	2	588
306810000	8413345098854	2	588
306812000	8413345098861	2	588
306815000	8413345098878	1	588
306820000	8413345098885	1	588
306903000	8413345123402	2	588
306904000	8413345123419	2	588
306905000	8413345123426	2	588
306906000	8413345123433	2	588
306908000	8413345123457	2	588
306910000	8413345123471	2	588
307401B	7314150254958	1	268
307411B	7314150254965	1	268
307421B	7314150254972	1	268
307431B	7314150254989	1	268
307441	7314150235933	1	268
307451	7314150235940	1	268
308504000	8413345035156	1	544
308505000	8413345035194	1	544
308506000	8413345035163	1	544
308508000	8413345035170	1	544
308510000	8413345035187	1	544
3090-20-XT11-HP	7311518181369	4	563
31	7314150004942	5	40
31 IP	7314150004959	50	40
31-T	7314150483709	5	40
31-T IP	7314150483723	50	40
3100TB	7314150125364	1	466
310M-24	7314151829612	1	56
310M-27	7314151829629	1	56
310M-30	7314151829636	1	56
310M-32	7314151829643	1	56
310M-36	7314151829650	1	56
310M-38	7314151829667	1	56
310M-41	7314151829674	1	56
310M-46	7314151829681	1	56
310M-50	7314151829698	1	56
310M-55	7314151829704	1	56
310M-60	7314151829711	1	56
310M-65	7314151829728	1	56
310M-70	7314151829735	1	56
310M-75	7314151829742	1	56
310M-80	7314151829759	1	56
310M-85	7314151829766	1	56
310M-90	7314151829773	1	56
310M-95	7314151829780	1	56
311-32	7314150120215	6	270
3115	7314150055326	1	364
3149-OR	7311518292249	1	461
3149-ORFF1	7314150292479	1	460
3149-ORTS1	7314150292066	1	461
3150-12-XT9-HP	7311518181406	4	560
315M-27	7314150133291	1	56
315M-30	7314150133307	1	56
315M-32	7314150133314	1	56
315M-36	7314150133321	1	56
315M-41	7314150133345	1	56
315M-46	7314150133352	1	56

315M-50	7314150133369	1	56
315M-55	7314150133376	1	56
315M-60	7314150133383	1	56
315M-65	7314150133390	1	56
315M-70	7314150133406	1	56
315M-75	7314150133413	1	56
315M-80	7314150133420	1	56
315Z-1.1/16	7314150133437	1	56
315Z-1.1/2	7314150133505	1	56
315Z-1.1/4	7314150133468	1	56
315Z-1.1/8	7314150133444	1	56
315Z-1.1.11/16	7314150133529	1	56
315Z-1.13/16	7314150133543	1	56
315Z-1.15/16	7314150133567	1	56
315Z-1.3/16	7314150133451	1	56
315Z-1.3/4	7314150133536	1	56
315Z-1.3/8	7314150133482	1	56
315Z-1.5/16	7314150133475	1	56
315Z-1.5/8	7314150133512	1	56
315Z-1.7/16	7314150133499	1	56
315Z-1.7/8	7314150133550	1	56
315Z-2	7314150133574	1	56
315Z-2.1/16	7314150133581	1	56
315Z-2.1/2	7314150133642	1	56
315Z-2.1/4	7314150133611	1	56
315Z-2.1/8	7314150133598	1	56
315Z-2.15/16	7314150133697	1	56
315Z-2.3/16	7314150133604	1	56
315Z-2.3/4	7314150133673	1	56
315Z-2.3/8	7314150133635	1	56
315Z-2.5/16	7314150133628	1	56
315Z-2.5/8	7314150133666	1	56
315Z-2.7/8	7314150133680	1	56
315Z-2.9/16	7314150133659	1	56
315Z-3	7314150133703	1	56
315Z-3.1/8	7314150133840	1	56
316-1	7311518296216	12	271
316-2	7311518296223	12	271
316-2-95	7311518296278	1	271
317	7311518240936	10	556
317-40	7311518296230	12	271
318-38	7311518296247	1	271
318-54	7311518296254	1	271
3180-14-XT11-HP	7311518181390	4	562
319	7311518240943	5	556
320	7311518265557	10	556
321	7311518001841	5	556
321-18-SB	7311518129125	10	558
321-24-SB	7311518129132	10	558
321-7-SB	7311518129149	10	558
322500300	8413345012829	1	535
322500500	8413345012836	1	535
322500800	8413345012843	1	535
322510300	8413345015899	1	535
322510400	8413345137386	1	535
322510500	8413345015905	1	535
322510600	8413345137393	1	535
322510700	8413345137409	1	535
322510800	8413345015912	1	535
3240-14-XT11-HP	7311518243005	4	562
325	7311518214852	5	556
325001000	8413345000505	1	535
3250010SH	8413345137492	1	535
326000200	8413345000529	1	535
326000300	8413345012881	1	535
326010200	8413345016100	1	535
326020200	8413345016117	1	535
326030200	8413345016124	1	535
327020500	7314150330584	1	535
327020500-SH1	7314150361021	1	535
327020500-SH2	7314150361038	1	535
327020500-SH3	7314150361045	1	535
327020500-SH4	7314150361052	1	535
3280M	7314151071318	1	50
329000330	8413345000741	1	535
329000500	8413345000758	1	535
331-15-23	7311518274658	5	633
331-21-51-KP	7311518003814	5	633
332-21-51	7311518229337	5	633
333	7311518005832	5	633
333-5	7311518005849	10	634
339-6T	7311518128371	4	629
33H	7314150266791	5	40
340-6T	7311518002008	4	629
341	7314150113729	1	266
3416 A	7314150216260	6	252
3416 A SH	7314150410941	1	252
3416 B	7314150411160	10	252
3416 B SH	7314150411191	10	252
3417 A	7314150216277	12	253
3418 A	7314150216284	1	252
3419 B	7314151812416	1	254
3419 B SH	7314150504381	1	254
341A	7314150476268	5	653
342	7314150113736	1	266
343	7314150113743	1	266





Table with 3 columns: Item number, EAN, and Quantity. Items range from 3740-250 to 3802-700-50-2.50-4.



Table with 3 columns: Item number, EAN, and Quantity. Items range from 3802-700-50-2.50-4-KA to 3809-650-50-2.50-4-KA.





420SH-60-300	7314150359677	12	588
420SH-80-160	7314150359684	12	588
4211-11-6T	7311518152000	4	635
4211-14-6T	7311518128883	4	635
4212-11-6T	7311518002060	4	635
4212-14-6T	7311518002077	4	635
422P-10	7311518248369	4	572
422P-12	7311518248376	4	572
422P-16	7311518248383	4	572
422P-20	7311518248390	4	572
422P-25	7311518248406	4	572
422P-6	7311518248352	4	572
4231	7314150100033	3	235
4239	7314150100088	3	235
424P-10	7311518238315	4	570
424P-12	7311518238322	4	570
424P-14	7311518238339	4	570
424P-15	7311518238346	4	570
424P-16	7311518238353	4	570
424P-18	7311518238360	4	570
424P-20	7311518238377	4	570
424P-22	7311518238384	4	570
424P-24	7311518238391	4	570
424P-25	7311518238407	4	570
424P-26	7311518238414	4	570
424P-28	7311518238421	4	570
424P-30	7311518238438	4	570
424P-32	7311518238445	4	570
424P-35	7311518238452	4	570
424P-38	7311518238469	4	570
424P-4	7311518238285	4	570
424P-40	7311518238476	4	570
424P-6	7311518238292	4	570
424P-8	7311518238308	4	570
424P-S3-EUR	7311518249199	1	570
424P-S6-EUR	7311518269968	1	571
424P-S6-GER	7311518280086	1	571
424P-S6-LR	7314150423804	1	570
424P-S6-PP	7314150326662	1	571
424P-S8-EUR	7311518276393	1	571
425-081	7311518010669	1	572
425-082	7311518010676	1	572
425-083	7311518010683	1	572
425-10	7311518004613	4	572
425-12	7311518004620	4	572
425-14	7311518004637	4	572
425-15	7311518017767	4	572
425-16	7311518004644	4	572
425-18	7311518004651	4	572
425-20	7311518004668	4	572
425-22	7311518004675	4	572
425-24	7311518005993	4	572
425-25	7311518004682	4	572
425-26	7311518006006	4	572
425-28	7311518004699	4	572
425-30	7311518004705	4	572
425-32	7311518004712	4	572
425-35	7311518017774	4	572
425-38	7311518004729	4	572
425-4	7311518030810	4	572
425-40	7311518017781	4	572
425-6	7311518004590	4	572
425-8	7311518004606	4	572
426-1000	7311518004309	1	539
426-1200	7311518004316	1	539
426-400	7311518004255	1	539
426-600	7311518004279	1	539
426-800	7311518004293	1	539
426TOR9	7314150125319	10	541
427-13	7314150403578	4	592
427-16	7311518025410	4	592
427-20	7311518025427	4	592
427-24	7314150402878	4	592
427-700	7314150338092	6	592
427-8	7314150402854	4	592
427S-16	7314150404247	4	592
427S-20	7314150404261	4	592
428-16	7311518012380	4	592
428-700	7314150338108	6	593
428F-13	7314150436392	4	592
428F-16	7314150436408	4	592
428F-20	7314150436422	4	592
428F-24	7314150436439	4	592
428F-8	7314150436378	4	592
428S-16	7314150424030	4	592
428S-20	7314150424047	4	592
429-13	7311518012250	4	592
429-16	7311518012403	4	592
429-20	7311518012410	4	592
429-8	7311518040703	4	592
42RM/S12	7314150384785	1	46
4307	7314151079444	1	60
4310	7314151079451	1	60
434-10	7311518238506	4	570
434-12	7311518238513	4	570
434-14	7311518238520	4	570



434-15	7311518238537	4	570
434-16	7311518238544	4	570
434-18	7311518238551	4	570
434-20	7311518238568	4	570
434-22	7311518238575	4	570
434-25	7311518238582	4	570
434-28	7311518238599	4	570
434-30	7311518238605	4	570
434-32	7311518238612	4	570
434-35	7311518238629	4	570
434-38	7311518238636	4	570
434-50	7311518285388	4	570
434-6	7311518238483	4	570
434-8	7311518238490	4	570
434-S3-EUR	7311518249212	1	570
434-S6-EUR	7311518267544	1	570
434-S6-LR	7314150423811	1	570
434-S6-PP	7314150326655	1	570
434-S8-EUR	7311518295110	1	570
439000000	8413345129282	1	473
439000001	7314150268788	1	473
439000002	7314150309702	1	473
439000003	7314150309719	1	473
439000004	7314150427666	1	473
4400-11	7311518200596	10	636
4400-11-BULK	7311518200633	10	636
4400-14	7311518200602	10	636
4400-14-BULK	7311518200640	10	636
440102500	8413345098977	10	595
440103000	8413345098991	10	595
4411-1.00	7314150372744	1	151
4411-1.50	7314150372768	1	151
4411-10.00	7314150372973	1	151
4411-10.20	7314150372980	1	151
4411-10.50	7314150470488	1	151
4411-11.00	7314150372997	1	151
4411-11.50	7314150470495	1	151
4411-12.00	7314150373000	1	151
4411-12.50	7314150470501	1	151
4411-13.00	7314150373017	1	151
4411-2.00	7314150372775	1	151
4411-2.50	7314150372782	1	151
4411-3.00	7314150372799	1	151
4411-3.25	7314150372805	1	151
4411-3.30	7314150372812	1	151
4411-3.50	7314150372829	1	151
4411-4.00	7314150372836	1	151
4411-4.20	7314150372843	1	151
4411-4.25	7314150372850	1	151
4411-4.50	7314150372867	1	151
4411-5.00	7314150372874	1	151
4411-5.50	7314150372881	1	151
4411-6.00	7314150372898	1	151
4411-6.50	7314150372904	1	151
4411-6.80	7314150372911	1	151
4411-7.00	7314150372928	1	151
4411-7.50	7314150372935	1	151
4411-8.00	7314150372942	1	151
4411-8.50	7314150372959	1	151
4411-9.00	7314150372966	1	151
4411-9.50	7314150394463	1	151
4413-1.00	7314150371754	1	152
4413-1.50	7314150371761	1	152
4413-10.00	7314150372034	1	152
4413-10.20	7314150372041	1	152
4413-10.50	7314150470556	25	152
4413-11.00	7314150372058	1	152
4413-11.50	7314150470563	25	152
4413-12.00	7314150372065	1	152
4413-12.50	7314150470570	25	152
4413-13.00	7314150372072	1	152
4413-2.00	7314150371785	1	152
4413-2.50	7314150371792	1	152
4413-3.00	7314150371815	1	152
4413-3.25	7314150371822	1	152
4413-3.30	7314150371877	1	152
4413-3.50	7314150371884	1	152
4413-4.00	7314150371891	1	152
4413-4.20	7314150371907	1	152
4413-4.25	7314150371914	1	152
4413-4.50	7314150371921	1	152
4413-5.00	7314150371938	1	152
4413-5.50	7314150371945	1	152
4413-6.00	7314150371952	1	152
4413-6.50	7314150371969	1	152
4413-6.80	7314150371976	1	152
4413-7.00	7314150371983	1	152
4413-7.50	7314150371990	1	152
4413-8.00	7314150372003	1	152
4413-8.50	7314150372010	1	152
4413-9.00	7314150372027	1	152
4413-9.50	7314150394456	1	152
4415-1.00	7314150394210	1	153
4415-1.50	7314150394227	1	153
4415-10.00	7314150394401	1	153
4415-10.50	7314150470525	1	153





4415-11.00	7314150394418	1	153
4415-11.50	7314150470532	1	153
4415-12.00	7314150394425	1	153
4415-12.50	7314150470549	1	153
4415-13.00	7314150394432	1	153
4415-13.50	7314150441495	1	153
4415-14.00	7314150441501	1	153
4415-14.50	7314150441518	1	153
4415-15.00	7314150441525	1	153
4415-15.50	7314150441532	1	153
4415-16.00	7314150441549	1	153
4415-16.50	7314150441556	1	153
4415-17.00	7314150441563	1	153
4415-17.50	7314150441570	1	153
4415-18.00	7314150441587	1	153
4415-18.50	7314150441594	1	153
4415-19.00	7314150441600	1	153
4415-19.50	7314150441617	1	153
4415-2.00	7314150394234	1	153
4415-2.50	7314150394241	1	153
4415-20.00	7314150441624	1	153
4415-3.00	7314150394258	1	153
4415-3.25	7314150394265	1	153
4415-3.50	7314150394272	1	153
4415-4.00	7314150394289	1	153
4415-4.25	7314150394296	1	153
4415-4.50	7314150394302	1	153
4415-5.00	7314150394319	1	153
4415-5.50	7314150394326	1	153
4415-6.00	7314150394333	1	153
4415-6.50	7314150394340	1	153
4415-7.00	7314150394357	1	153
4415-7.50	7314150394364	1	153
4415-8.00	7314150394371	1	153
4415-8.50	7314150394388	1	153
4415-9.00	7314150394395	1	153
442	7311518002848	10	548
442 B	7314150008957	1	266
442-3P	7314150309610	10	548
4420-11	7311518200619	10	636
4420-11-BULK	7311518200657	10	636
4420-14	7311518200626	10	636
4420-14-BULK	7311518200664	10	636
443 B	7314150008971	1	266
4430	7314150100040	3	245
4435-12.4	7314150465163	1	154
444 B	7314150009008	1	266
4480/2-ZD	7311518276911	1	271
4480IM	7314150263165	1	271
4480MM	7314150263158	1	271
449	7311518005337	10	548
44Z-1/2-9/16	7314150375233	10	53
44Z-1/4-5/16	7314150375196	10	53
44Z-11/16-13/16	7314150375264	5	53
44Z-11/16-3/4	7314150375257	5	53
44Z-3/8-7/16	7314150375219	10	53
44Z-5/16-3/8	7314150375202	10	53
44Z-5/8-3/4	7314150375240	5	53
44Z-7/16-1/2	7314150375226	10	53
451	7311518014506	10	548
4511-0.50-10P	7314150373079	1	151
4511-0.75-10P	7314150373062	1	151
4511-1.00-10P	7314150373055	1	151
4511-1.50-10P	7314150373086	1	151
4511-1.75-10P	7314150373093	1	151
4511-10.00-5P	7314150373444	1	151
4511-10.20-5P	7314150373468	1	151
4511-10.30-5P	7314150373475	1	151
4511-10.50-5P	7314150373482	1	151
4511-10.80-5P	7314150373499	1	151
4511-11.00-5P	7314150373505	1	151
4511-11.50-5P	7314150373512	1	151
4511-12.00-5P	7314150373529	1	151
4511-12.50-5P	7314150373536	1	151
4511-12.80-5P	7314150373543	1	151
4511-13.00-5P	7314150373550	1	151
4511-13.50-1P	7314150373567	1	151
4511-14.00-1P	7314150373574	1	151
4511-14.50-1P	7314150373581	1	151
4511-15.00-1P	7314150373598	1	151
4511-15.50-1P	7314150373604	1	151
4511-16.00-1P	7314150373611	1	151
4511-16.50-1P	7314150373628	1	151
4511-17.00-1P	7314150373635	1	151
4511-17.50-1P	7314150373642	1	151
4511-18.00-1P	7314150373659	1	151
4511-18.50-1P	7314150373673	1	151
4511-19.00-1P	7314150373680	1	151
4511-19.50-1P	7314150373697	1	151
4511-2.00-10P	7314150373109	1	151
4511-2.50-10P	7314150373116	1	151
4511-2.70-10P	7314150373123	1	151
4511-2.90-10P	7314150373130	1	151
4511-20.00-1P	7314150373666	1	151
4511-3.00-10P	7314150373147	1	151
4511-3.10-10P	7314150373185	1	151



4511-3.25-10P	7314150373192	1	151
4511-3.30-10P	7314150373208	1	151
4511-3.50-10P	7314150373215	1	151
4511-3.80-10P	7314150373222	1	151
4511-4.00-10P	7314150373239	1	151
4511-4.20-10P	7314150373246	1	151
4511-4.50-10P	7314150373253	1	151
4511-4.80-10P	7314150373260	1	151
4511-5.00-10P	7314150373277	1	151
4511-5.20-10P	7314150373284	1	151
4511-5.50-10P	7314150373291	1	151
4511-6.00-10P	7314150373307	1	151
4511-6.20-10P	7314150373314	1	151
4511-6.50-10P	7314150373321	1	151
4511-6.80-10P	7314150373338	1	151
4511-7.00-10P	7314150373345	1	151
4511-7.20-10P	7314150373352	1	151
4511-7.50-10P	7314150373369	1	151
4511-7.80-10P	7314150373376	1	151
4511-8.00-10P	7314150373383	1	151
4511-8.50-10P	7314150373390	1	151
4511-8.60-10P	7314150373406	1	151
4511-8.80-10P	7314150373413	1	151
4511-9.00-10P	7314150373420	1	151
4511-9.20-10P	7314150373437	1	151
4511-9.50-10P	7311518339081	1	151
4511-9.60-10P	7314150373451	1	151
4511-SET-19	7314150373031	1	151
4511-SET-25	7314150373048	1	152
4511-SET-6	7314150373024	1	151
4513-1.00-10P	7314150372119	1	152
4513-1.50-10P	7314150372126	1	152
4513-1.75-10P	7314150372133	1	152
4513-10.00-5P	7314150391998	1	152
4513-10.20-5P	7314150392001	1	152
4513-10.30-5P	7314150392018	1	152
4513-10.50-5P	7314150392025	1	152
4513-10.80-5P	7314150392032	1	152
4513-11.00-5P	7314150392049	1	152
4513-11.50-5P	7314150392056	1	152
4513-12.00-5P	7314150392063	1	152
4513-12.50-5P	7314150392070	1	152
4513-12.80-5P	7314150392087	1	152
4513-13.00-5P	7314150392094	1	152
4513-13.50-1P	7314150392100	1	152
4513-14.00-1P	7314150392117	1	152
4513-14.50-1P	7314150392124	1	152
4513-15.00-1P	7314150392131	1	152
4513-15.50-1P	7314150392148	1	152
4513-16.00-1P	7314150392155	1	152
4513-16.50-1P	7314150392162	1	152
4513-17.00-1P	7314150392179	1	152
4513-17.50-1P	7314150392186	1	152
4513-18.00-1P	7314150392193	1	152
4513-18.50-1P	7314150392200	1	152
4513-19.00-1P	7314150392216	1	152
4513-19.50-1P	7314150392223	1	152
4513-2.00-10P	7314150372140	1	152
4513-2.50-10P	7314150372157	1	152
4513-2.70-10P	7314150372164	1	152
4513-2.90-10P	7314150372171	1	152
4513-20.00-1P	7314150392230	1	152
4513-3.00-10P	7314150372188	1	152
4513-3.10-10P	7314150372195	1	152
4513-3.25-10P	7314150372201	1	152
4513-3.30-10P	7314150372218	1	152
4513-3.50-10P	7314150372225	1	152
4513-3.80-10P	7314150372232	1	152
4513-4.00-10P	7314150372249	1	152
4513-4.20-10P	7314150372256	1	152
4513-4.50-10P	7314150372263	1	152
4513-4.80-10P	7314150372270	1	152
4513-5.00-10P	7314150372287	1	152
4513-5.20-10P	7314150372294	1	152
4513-5.50-10P	7314150372300	1	152
4513-6.00-10P	7314150372317	1	152
4513-6.20-10P	7314150372324	1	152
4513-6.50-10P	7314150372331	1	152
4513-6.80-10P	7314150372348	1	152
4513-7.00-10P	7314150372355	1	152
4513-7.20-10P	7314150372362	1	152
4513-7.50-10P	7314150372379	1	152
4513-7.80-10P	7314150372386	1	152
4513-8.00-10P	7314150372393	1	152
4513-8.50-10P	7314150372409	1	152
4513-8.60-10P	7314150372416	1	152
4513-8.80-10P	7314150372423	1	152
4513-9.00-10P	7314150372430	1	152
4513-9.20-10P	7314150372447	1	152
4513-9.50-10P	7314150372454	1	152
4513-9.60-10P	7314150372461	1	152
4513-SET-19	7314150372096	1	152
4513-SET-25	7314150372102	1	153
4513-SET-6	7314150372089	1	152
4515-1.00-10P	7314150441228	1	153
4515-1.50-10P	7314150441235	1	153

Part Number	Quantity	Price
4515-10.00-10P	1	153
4515-10.50-5P	1	153
4515-11.00-5P	1	153
4515-11.50-5P	1	153
4515-12.00-5P	1	153
4515-12.50-5P	1	153
4515-13.00-5P	1	153
4515-2.00-10P	1	153
4515-2.50-10P	1	153
4515-3.00-10P	1	153
4515-3.25-10P	1	153
4515-3.50-10P	1	153
4515-4.00-10P	1	153
4515-4.25-10P	1	153
4515-4.50-10P	1	153
4515-5.00-10P	1	153
4515-5.50-10P	1	153
4515-6.00-10P	1	153
4515-6.50-10P	1	153
4515-7.00-10P	1	153
4515-7.50-10P	1	153
4515-8.00-10P	1	153
4515-8.50-10P	1	153
4515-9.00-10P	1	153
4515-9.50-10P	1	153
4515-SET-19	1	153
4515-SET-25	1	153
4518-3	1	367
4518-4	1	367
4518-5	1	367
4519-1	1	366
4519-1/S	1	365
4519-2	1	366
4519-3	1	366
4521N-0	1	367
4521N-00	1	367
4521N-A	1	367
4521N-B	1	367
4521N-C	1	367
4521N-D	1	367
4521N-E	1	367
4521N-F	1	367
4521N-G	1	367
4521N-H	1	367
4521N-I	1	367
4521N-K	1	367
4521N-L	1	367
4521N-M	1	367
4521N-S	1	367
4521N-T	1	367
4521N/7	1	367
4522-1	1	367
4522-2	1	367
4523G	1	367
4524G	1	367
4528-1	1	365
4528M1	1	365
4528M2	1	365
4528M3	1	365
4528M4	1	365
4528M5	1	365
4529-15	1	364
4529-8	1	364
4530	3	246
4532-0	1	364
4532-A	1	364
4532-AL	1	364
4532-B	1	364
4532-BL	1	364
4532-C	1	364
4532-CD/S	1	364
4532-CL	1	364
4532-D	1	364
4532-E	1	364
4532-EFG/S	1	364
4532-F	1	364
4532-G	1	364
4532-G-SO	1	364
4532-H	1	364
4532-H/S	1	364
4532-OAB/S	1	364
4532K1	1	364
4532K2	1	364
4532K3	1	364
4532K4	1	364
4532LK1	1	364
4532LK2	1	364
4532LK3	1	364
4532LK4	1	364
4532LK5	1	364
4532ST/5	1	364
4533HP	1	364
4533HP/S	1	364
4533HPK	1	364
4533M	1	364
4533M/S	1	364

Part Number	Quantity	Price
4533MK	1	364
4537-1	1	365
4537-2	1	365
4537-3	1	365
4537-4	1	365
4540-17	1	366
4540-17/S	1	366
4540-25	1	366
4540-25/S	1	366
4541-A	1	365
4541-B	1	365
4542-A	1	365
4542-B	1	365
4543-1	1	365
4543-1/S	1	365
4543-10	1	365
4543-2	1	365
4543-2/S	1	365
4543-20	1	365
4543-3	1	365
4543-3/S	1	365
4543-30	1	365
4544-1	1	365
4544-10	1	365
4544-110/S	1	365
4544-2	1	365
4544-20	1	365
4544-220/S	1	365
4544-3	1	365
4544-30	1	365
4544-4	1	365
4544-440/S	1	365
4545-1	1	368
4545-2	1	368
4545-3	1	368
4545-4	1	368
4545-5	1	368
4545-N1	1	367
4545-N11	1	367
4545-N2	1	367
4545-N21	1	367
4551-A	1	366
4551-B	1	366
4551-C	1	366
4551-D	1	366
4552-1	1	366
4552-2	1	366
4552-3	1	366
4553	1	368
4559-12	1	239
4559-12A JC	1	239
4559-18	8	239
4559-18B JC	1	239
4559-24	6	239
4559-24B JC	1	239
4559-30	5	239
4559-30B JC	1	239
4559-36	3	239
4559-36B JC	1	239
4559-42	2	239
4559-42A JC	1	239
4560-210	1	239
4574	1	366
4577	1	368
4578	1	367
4579	1	368
4580N/7	1	366
4581N-1	1	366
4581NA	1	366
4581NB	1	366
4581NB2	1	366
4581NC	1	366
4582N-1	1	366
4582N-2	1	366
4582NA	1	366
4582NB	1	366
4583N-1	1	366
4583N-2	1	366
4583NA	1	366
4583NB	1	366
4590SHS5	4	368
4591	1	368
4592	1	368
4593	1	368
4594VWT4	5	335
45S/H1.5	1	165
45S/H1.5-2P	1	165
45S/H2	1	165
45S/H2-2P	1	165
45S/H2.5	1	165
45S/H2.5-2P	1	165
45S/H3	1	165
45S/H3-2P	1	165
45S/PH1	1	165
45S/PH1-2P	1	165
45S/PH2	1	165



45S/PH2-2P



45S/PH2-2P	7314150261499	1	165
4610-1	7314151724993	1	368
4611-2	7314151725372	1	368
4611-3	7314150125043	1	368
4614-1	7314151725457	1	366
4614-2	7314151725532	1	366
4626-10.0	7314150457670	1	156
4626-4.0	7314150457632	1	156
4626-5.0	7314150457649	1	156
4626-6.0	7314150457656	1	156
4626-8.0	7314150457663	1	156
4629-10.0	7314150465385	1	156
4629-4.0	7314150465347	1	156
4629-5.0	7314150465354	1	156
4629-6.0	7314150465361	1	156
4629-8.0	7314150465378	1	156
4629-SET-5	7314150467204	10	156
4630	7314150216154	1	610
4641-10-120	7314150383085	1	150
4641-10-200	7314150383115	1	150
4641-10-400	7314150383207	1	150
4641-10-600	7314150383221	1	150
4641-11-150	7314150383122	1	150
4641-12-150	7314150383139	1	150
4641-12-200	7314150383146	1	150
4641-12-400	7314150383238	1	150
4641-12-600	7314150383245	1	150
4641-13-150	7314150383153	1	150
4641-14-150	7314150383160	1	150
4641-14-400	7314150383252	1	150
4641-14-600	7314150383269	1	150
4641-16-150	7314150383177	1	150
4641-16-400	7314150383276	1	150
4641-16-600	7314150383283	1	150
4641-18-400	7314150383290	1	150
4641-18-600	7314150383306	1	150
4641-20-400	7314150383313	1	150
4641-20-600	7314150383320	1	150
4641-22-400	7314150383337	1	150
4641-24-400	7314150383344	1	150
4641-25-400	7314150383351	1	150
4641-3-60	7314150382859	1	150
4641-4-75	7314150382866	1	150
4641-5-150	7314150382880	1	150
4641-5-85	7314150382873	1	150
4641-5,5-85	7314150382897	1	150
4641-6-100	7314150383016	1	150
4641-6-150	7314150383023	1	150
4641-6-400	7314150383184	1	150
4641-6,5-100	7314150383030	1	150
4641-7-100	7314150383047	1	150
4641-8-120	7314150383054	1	150
4641-8-200	7314150383061	1	150
4641-8-400	7314150383191	1	150
4641-9-120	7314150383078	1	150
4641-PB	7314150383368	1	150
4643-PB	7314150441679	1	150
4651-10-1000	7314150386413	1	149
4651-10-110	7314150386345	1	149
4651-10-160	7314150386352	1	149
4651-10-160-10P	7314150475483	1	149
4651-10-210	7314150386369	1	149
4651-10-210-10P	7314150475513	1	149
4651-10-260	7314150386376	1	149
4651-10-310	7314150386383	1	149
4651-10-450	7314150386390	1	149
4651-10-600	7314150386406	1	149
4651-12-1000	7314150386581	1	149
4651-12-160	7314150386529	1	149
4651-12-160-10P	7314150475490	1	149
4651-12-210	7314150386536	1	149
4651-12-210-10P	7314150475520	1	149
4651-12-260	7314150386543	1	149
4651-12-310	7314150386550	1	149
4651-12-450	7314150386567	1	149
4651-12-600	7314150386574	1	149
4651-14-1000	7314150386659	1	149
4651-14-160	7314150386598	1	149
4651-14-210	7314150386604	1	149
4651-14-260	7314150386611	1	149
4651-14-310	7314150386628	1	149
4651-14-450	7314150386635	1	149
4651-14-600	7314150386642	1	149
4651-15-160	7314150386666	1	149
4651-15-260	7314150386673	1	149
4651-15-450	7314150386680	1	149
4651-16-1000	7314150386765	1	149
4651-16-160	7314150386697	1	149
4651-16-210	7314150386710	1	149
4651-16-260	7314150386727	1	149
4651-16-310	7314150386734	1	149
4651-16-450	7314150386741	1	149
4651-16-600	7314150386758	1	149
4651-18-250	7314150386789	1	149
4651-18-450	7314150386796	1	149
4651-20-250	7314150386802	1	149



4651-20-450	7314150386819	1	149
4651-22-250	7314150386826	1	149
4651-22-450	7314150386833	1	149
4651-24-250	7314150386840	1	149
4651-24-450	7314150386857	1	149
4651-25-250	7314150386864	1	149
4651-25-450	7314150386871	1	149
4651-28-250	7314150386888	1	149
4651-28-450	7314150386895	1	149
4651-30-250	7314150386901	1	149
4651-30-450	7314150386918	1	149
4651-32-450	7314150386925	1	149
4651-5-110	7314150385683	1	149
4651-5-110-10P	7314150475407	1	149
4651-5-160	7314150385690	1	149
4651-5-160-10P	7314150475438	1	149
4651-5-260	7314150385713	1	149
4651-5,5-110	7314150385720	1	149
4651-5,5-110-10P	7314150475414	10	149
4651-5,5-160	7314150385737	1	149
4651-5,5-160-10P	7314150475445	1	149
4651-6-110	7314150385744	1	149
4651-6-110-10P	7314150475421	1	149
4651-6-160	7314150385751	1	149
4651-6-160-10P	7314150475452	1	149
4651-6-210	7314150385768	1	149
4651-6-260	7314150385775	1	149
4651-6-310	7314150385782	1	149
4651-6,5-110	7314150475391	50	149
4651-6,5-160	7314150385799	1	149
4651-6,5-160-10P	7314150475469	1	149
4651-6,5-210	7314150385805	1	149
4651-6,5-260	7314150385812	1	149
4651-6,5-310	7314150385829	1	149
4651-7-110	7314150385836	1	149
4651-7-160	7314150386253	1	149
4651-8-110	7314150386277	1	149
4651-8-160	7314150386284	1	149
4651-8-160-10P	7314150475476	1	149
4651-8-210	7314150386291	1	149
4651-8-210-10P	7314150475506	1	149
4651-8-260	7314150386307	1	149
4651-8-310	7314150386314	1	149
4651-8-460	7314150386321	1	149
4651-SET-5	7314150475537	1	149
4651-SET-7	7314150475544	1	149
4652-10-110	7314150385119	1	149
4652-10-160	7314150385126	1	149
4652-10-160-10P	7314150475322	1	149
4652-10-210	7314150385133	1	149
4652-10-210-10P	7314150475353	1	149
4652-10-260	7314150385140	1	149
4652-10-310	7314150385164	1	149
4652-10-450	7314150385171	1	149
4652-10-600	7314150385188	1	149
4652-11-160	7314150385195	1	149
4652-11-260	7314150385218	1	149
4652-12-1000	7314150385287	1	150
4652-12-160	7314150385225	1	149
4652-12-160-10P	7314150475339	1	149
4652-12-210	7314150385232	1	149
4652-12-210-10P	7314150475360	1	149
4652-12-260	7314150385249	1	149
4652-12-310	7314150385256	1	149
4652-12-450	7314150385263	1	150
4652-12-600	7314150385270	1	150
4652-13-310	7314150385300	1	150
4652-14-1000	7314150385379	1	150
4652-14-160	7314150385317	1	150
4652-14-210	7314150385324	1	150
4652-14-260	7314150385331	1	150
4652-14-310	7314150385348	1	150
4652-14-450	7314150385355	1	150
4652-14-600	7314150385362	1	150
4652-15-260	7314150385393	1	150
4652-16-1000	7314150385478	1	150
4652-16-210	7314150385416	1	150
4652-16-260	7314150385423	1	150
4652-16-310	7314150385430	1	150
4652-16-450	7314150385447	1	150
4652-16-600	7314150385454	1	150
4652-18-1000	7314150385515	1	150
4652-18-200	7314150385485	1	150
4652-18-300	7314150385492	1	150
4652-18-450	7314150385508	1	150
4652-20-1000	7314150385560	1	150
4652-20-200	7314150385522	1	150
4652-20-300	7314150385539	1	150
4652-20-450	7314150385546	1	150
4652-20-600	7314150385553	1	150
4652-22-1000	7314150385607	1	150
4652-22-250	7314150385577	1	150
4652-22-450	7314150385584	1	150
4652-22-600	7314150385591	1	150
4652-24-250	7314150385614	1	150
4652-24-450	7314150385621	1	150



4652-25-1000	7314150385652	1	150
4652-25-250	7314150385638	1	150
4652-25-450	7314150385645	1	150
4652-26-250	7314150385669	1	150
4652-26-450	7314150385676	1	150
4652-3-110	7314150475216	50	149
4652-3.5-110	7314150475223	50	149
4652-4-110	7314150384365	1	149
4652-4-160	7314150384372	1	149
4652-5-110	7314150384815	1	149
4652-5-110-10P	7314150475247	1	149
4652-5-160	7314150384839	1	149
4652-5-160-10P	7314150475278	1	149
4652-5-210	7314150384846	1	149
4652-5.5-110	7314150384853	1	149
4652-5.5-110-10P	7314150475254	10	149
4652-5.5-160	7314150384860	1	149
4652-5.5-160-10P	7314150475285	1	149
4652-5.5-210	7314150475230	50	149
4652-6-110	7314150384877	1	149
4652-6-110-10P	7314150475261	1	149
4652-6-160	7314150384891	50	149
4652-6-160-10P	7314150475292	1	149
4652-6-210	7314150384907	1	149
4652-6-260	7314150384969	1	149
4652-6.5-110	7314150384976	1	149
4652-6.5-160	7314150384990	1	149
4652-6.5-160-10P	7314150475308	1	149
4652-7-110	7314150385003	1	149
4652-7-160	7314150391981	1	149
4652-8-110	7314150385034	1	149
4652-8-160	7314150385058	1	149
4652-8-160-10P	7314150475315	1	149
4652-8-210	7314150385065	1	149
4652-8-210-10P	7314150475346	1	149
4652-8-260	7314150385072	1	149
4652-8-460	7314150385089	1	149
4652-9-160	7314150385096	1	149
4652-9-210	7314150385102	1	149
4652-SET-5	7314150475377	1	150
4652-SET-7	7314150475384	1	150
4655-FLAT-250	7314150387823	1	151
4655-HOLLOW-240	7314150387847	1	151
4655-POINT-250	7314150387816	1	151
4655-SLOT-25032	7314150387885	1	151
4655-TILE-20040	7314150387861	1	151
4655-WIDE-20040	7314150387830	1	151
4655-WING-C-250	7314150387854	1	151
4656-12-340	7314150386932	1	148
4656-12-540	7314150387021	1	148
4656-14-340	7314150387069	1	148
4656-14-540	7314150387076	1	148
4656-15-340	7314150387083	1	148
4656-16-1320	7314150387137	1	148
4656-16-340	7314150387106	1	148
4656-16-540	7314150387113	1	148
4656-16-940	7314150387120	1	148
4656-18-1320	7314150387175	1	148
4656-18-340	7314150387144	1	148
4656-18-540	7314150387151	1	148
4656-18-940	7314150387168	1	148
4656-20-1320	7314150387212	1	148
4656-20-320	7314150387182	1	148
4656-20-520	7314150387199	1	148
4656-20-920	7314150387205	1	148
4656-22-1320	7314150387250	1	148
4656-22-320	7314150387229	1	148
4656-22-520	7314150387236	1	148
4656-22-920	7314150387243	1	148
4656-24-320	7314150387267	1	148
4656-24-520	7314150387274	1	148
4656-25-1320	7314150387311	1	148
4656-25-320	7314150387281	1	148
4656-25-520	7314150387298	1	148
4656-25-920	7314150387304	1	148
4656-26-520	7314150387328	1	148
4656-28-370	7314150387434	1	148
4656-28-570	7314150387458	1	148
4656-28-670	7314150387489	1	148
4656-28-920	7314150387526	1	148
4656-30-370	7314150387540	1	148
4656-30-570	7314150387571	1	148
4656-32-1320	7314150387649	1	148
4656-32-370	7314150387595	1	148
4656-32-570	7314150387618	1	148
4656-32-920	7314150387632	1	148
4656-35-370	7314150387656	1	148
4656-35-570	7314150387663	1	148
4656-35-670	7314150387670	1	148
4656-37-370	7314150387687	1	148
4656-37-570	7314150387694	1	148
4656-37-920	7314150387700	1	148
4656-38-370	7314150387717	1	148
4656-38-570	7314150387724	1	148
4656-40-1320	7314150387762	1	148
4656-40-370	7314150387731	1	148



4656-40-570	7314150387748	1	148
4656-40-920	7314150387755	1	148
4656-45-570	7314150387779	1	148
4656-45-920	7314150387786	1	148
4656-50-570	7314150387793	1	148
4656-52-570	7314150387809	1	148
4659-FLAT -28	7314150387922	1	151
4659-FLAT -40	7314150387939	1	151
4659-FLAT -60	7314150387946	1	151
4659-POINT-28	7314150387892	1	151
4659-POINT-40	7314150387908	1	151
4659-POINT-60	7314150387915	1	151
4659-TILE-30-5	7314150388042	1	151
4659-TILE-30-8	7314150388059	1	151
4659-WIDE-30-8	7314150387953	1	151
4659-WIDE-36-5	7314150387984	1	151
466-1000	7314150128327	4	539
466-1000-M	7314150186105	4	539
466-1200	7314150128334	4	539
466-1200-M	7314150186129	4	539
466-1800	7314150128341	4	539
466-2000	7314150129836	4	539
466-250	7314150128655	10	541
466-400	7314150128297	4	539
466-400-M	7314150128358	4	539
466-600	7314150128303	4	539
466-600-M	7314150128365	4	539
466-800	7314150128310	4	539
466-800-M	7314150186082	4	539
466-BE1	7314150215218	12	541
466-LINE	7314150215249	12	541
466-POST	7314150215232	6	541
4724-JT	7311518265847	1	635
4728-JT	7311518265854	1	635
474-125-0.60	7311518029050	10	549
474-125-0.80	7311518029869	10	549
474-150-0.60	7311518029876	10	549
474-150-0.80	7311518029883	10	549
4750-2PP-1	7314153014733	1	469
4750-3PB-2	7314150187782	1	474
4750-BWC-1	7314153018809	1	469
4750-DHO-3	7314150289530	1	469
4750-EP-1	7314153014726	1	469
4750-FOLTIC-1	7314153019271	1	467
4750-HDB-2	7314150289486	1	468
4750-HDBS-2	7314150289479	1	468
4750-HDLB-1	7314153014757	1	468
4750-HDLB-TAH	7314150303892	1	474
4750-HHO-2	7314153014863	1	474
4750-JU3PB-1	7314153015747	1	468
4750-KNHO-1	7314153015839	1	469
4750-KP-1	7314153014771	1	469
4750-LV-1	7314150358052	1	467
4750-LV-2	7314150393800	1	467
4750-MPH-1	7314150291625	1	469
4750-QRFB-1	7314150289455	1	468
4750-ROCO-1	7314153015273	1	469
4750-TOCST-1	7314153018779	1	467
4750-UP-2	7314150187768	1	474
4750-VDEC	7314150223377	1	468
4750-VMPH-1	7314153014818	1	469
4750ALC01FF1	7314150508884	1	440
4750BMC10	7314150264032	1	463
4750BMC10FF1	7314150500673	1	462
4750BMC3	7314150359639	1	463
4750BMC4	7314150426256	1	463
4750BMC5	7314150264001	1	463
4750BMC5.5	7314150326167	1	463
4750BMC6	7314150264018	1	463
4750BMC7	7314150277605	1	463
4750BMC9	7314150264025	1	463
4750BMC9.5	7314150326174	1	463
4750BMC11	7314150541294	1	121
4750FB1-19A	7314150277612	1	466
4750FB1-19B	7314150277629	4	466
4750FB2-19A	7314150277636	4	466
4750FB2-19TS001	7314150302772	1	463
4750FB2-24A	7314150277643	2	466
4750FB2W-24A	7314150277650	1	466
4750FB2W-TS001	7314150302765	1	463
4750FB3-12	7314150277667	1	466
4750FB4-18	7314150277674	4	466
4750FB4-18TS001	7314150302758	1	464
4750FB5-FG1	7314150401796	1	467
4750FB5-FG2	7314150401819	1	467
4750FB5A	7314150277704	1	467
4750FB5ATS001	7314150302727	1	465
4750FB5B	7314150277698	1	467
4750FB5BFF1	7314150302734	1	465
4750FB5C	7314150277681	8	467
4750FB6-13	7314150393091	1	466
4750FB6-19	7314150393114	1	467
4750FB7-01	7314150465668	60	468
4750FB7-02	7314150465675	60	468
4750FB7ORBG	7314150465682	120	468
4750FB7ORLT	7314150465699	120	468





4750FB8	7314150465651	4	465
4750PTB50	7314150275007	3	463
4750PTB60	7314150275014	3	463
4750PTB65	7314150345809	2	463
4750PTB65TS5	7314150456260	1	462
4750PTBW47	7314150275021	1	462
4750PTBW67	7314150289189	1	462
4750RC01	7314150220151	1	443
4750RC02	7314150220168	1	443
4750RC021	7314150226641	1	443
4750RCHD-AC1	7314150229857	1	444
4750RCHD00	7314150271603	1	443
4750RCHD01	7314150227426	1	442
4750RCHD011	7314150229802	1	443
4750RCHD01AC1	7314150229819	1	444
4750RCHD01AC2	7314150229826	1	444
4750RCHD01FF1	7314150247578	1	440
4750RCHDW01	7314150227433	1	442
4750RCHDW01AC1	7314150229833	1	444
4750RCHDW01AC2	7314150229840	1	444
4750RCHDW01FF1	7314150247561	1	439
4750RCHDW01FF2	7314150249183	1	439
4750RCHDW01FF3	7314150249190	1	439
4750RCHDW01FF4	7314150309580	1	440
4750RCHDW01FF9	7314150345533	1	440
4750RCHDW01RED	7314150407538	1	442
4750RCHDW02	7314150227440	1	442
4750RCHDW02FF1	7314150267422	1	437
4750RCHDW02FF15	7314150347698	1	439
4750RCHDW02FF2	7314150306787	1	438
4750RCHDW02FF4	7314150309559	1	438
4750RCHDW02RED	7314150407545	1	442
4750RCHDW02RF1V	7314150422081	1	437
4750RCHDW10	7314150425587	1	442
4750RCW01	7314150220182	1	443
4750RCW011	7314150226627	1	443
4750RCWD-AC1	7314150277179	1	443
4750RCWD-AC2	7314150277186	1	443
4750RCWD-AC3	7314150277193	1	443
4750RCWD-AC4	7314150277209	1	443
4750RCWD4	7314150277124	1	442
4750RCWD4-OR	7314150409501	1	442
4750RCWD4FF1	7314150302413	1	436
479-08	7311518025441	6	593
479-12	7311518025458	6	593
479-16	7311518025465	6	593
479-20	7314150319862	6	593
479-24	7311518025472	6	593
479-32	7311518025489	6	593
479F-08	7314150441952	6	593
479F-12	7314150441976	6	593
479F-16	7314150441983	6	593
479F-20	7314150441990	6	593
479F-24	7314150442003	6	593
479F-32	7314150442010	6	593
480-08	7311518025496	4	594
480-10	7311518025502	6	594
480-12	7311518025519	6	594
480-14	7311518025526	4	594
480-20	7314150319763	4	594
481-100	7311518005030	6	593
481-1000	7311518005092	6	593
481-1500	7311518025533	6	593
481-200	7311518005047	6	593
481-2000	7314150319855	6	593
481-300	7311518005054	6	593
481-400	7311518005061	6	593
481-500	7311518005078	6	593
481-800	7311518025540	6	593
481F-100	7314150442072	6	593
481F-1000	7314150442133	6	593
481F-1500	7314150442140	4	593
481F-200	7314150442089	4	593
481F-2000	7314150442157	4	593
481F-300	7314150442096	6	593
481F-400	7314150442102	6	593
481F-500	7314150442119	6	593
481F-800	7314150442126	6	593
482-25	7311518025557	6	593
482-28	7311518025564	6	593
482-30	7311518025571	6	593
482-35	7311518025595	6	593
482-40	7311518025601	6	593
482-45	7311518027551	6	593
482F-25	7314150442225	4	593
482F-28	7314150442232	4	593
482F-30	7314150442249	6	593
482F-35	7314150442256	4	593
482F-40	7314150442263	2	593
482F-45	7314150442270	4	593
483-16	7311518024314	6	594
483-20	7311518024321	6	594
483-22	7311518005108	6	594
483-25	7311518005115	6	594
483-28	7311518024284	6	594
4830	7314150100057	3	242



4831	7314150103393	3	242
4833	7314150100064	3	243
483F-16	7314150442164	6	594
483F-20	7314150442171	6	594
483F-22	7314150442188	6	594
483F-25	7314150442195	6	594
483F-28	7314150442201	6	594
483F-30	7314150442218	4	594
484-1000	7311518005122	6	594
484-1250	7311518005139	6	594
484-1500	7311518005146	6	594
484-2000	7311518024338	4	594
484F-1000	7314150442027	6	594
484F-1250	7314150442034	6	594
484F-1500	7314150442041	6	594
484F-2000	7314150442058	4	594
485	7311518005153	6	594
485W-650	7314150319770	6	594
485W-750	7314150319787	6	594
486	7311518005160	4	595
486-1800	7314150315307	5	541
486-1800WH	7314150315338	5	541
486-2000	7314150315314	5	541
486-2000WH	7314150315345	5	541
486-2400	7314150315321	5	541
486-2400WH	7314150315352	5	541
486-700	7314150338078	6	595
486F-700	7314150338085	6	595
486W-500	7314150319794	4	595
486W-600	7314150319800	4	595
488-2000	7314150337972	2	595
488-3000	7314150337989	2	595
488-4000	7314150337996	2	595
488-5000	7314150338009	2	595
488-6000	7314150338016	1	595
488F-2000	7314150338023	2	595
488F-3000	7314150338030	2	595
488F-4000	7314150338047	2	595
488F-5000	7314150338054	4	595
488F-6000	7314150338061	2	595
489-1100	7314150133055	8	597
489-1800	7314150133062	8	597
489-2700	7314150133079	4	597
489-3600	7314150133086	4	597
489-4500	7314150133093	4	597
489-5400	7314150133109	4	597
490-3.5	7311518025373	4	594
491-3000	7314150345199	4	597
491-4000	7314150345205	4	597
491-5000	7314150345212	4	597
491-6000	7314150345229	4	597
492-3.5	7311518025380	6	594
493-500	7314150338139	6	596
493-600	7314150338146	6	596
493F-500	7314150338153	6	596
493F-600	7314150338160	1	596
494-600	7311518025397	4	596
495-500	7314150338191	6	596
495-600	7314150338207	6	596
495F-500	7314150338184	6	596
495F-600	7314150338177	1	596
496-1500	7314150315147	5	541
496-1800	7314150315154	5	541
496-SPARE	7314150329304	1	542
4M-10-11	7314151829438	10	53
4M-12-13	7314151829445	10	53
4M-14-15	7314151829476	10	53
4M-16-17	7314151829490	10	53
4M-17-19	7314151829506	10	53
4M-18-19	7314151829513	10	53
4M-20-22	7314151829520	10	53
4M-21-23	7314150205363	5	53
4M-24-26	7314150205370	1	53
4M-24-27	7314151829551	1	53
4M-25-28	7314150205387	1	53
4M-27-29	7314150205394	1	53
4M-30-32	7314151829575	1	53
4M-6-7	7314151829407	10	53
4M-8-9	7314151829414	10	53
4M/10C	7314150212972	1	53
4M/10T	7314151829605	1	53
4M/12C	7314150212989	1	54
4M/8	7314150180493	1	54
5-600-21-D-1P	7311518189341	10	35
5-610-21-D-1P	7311518189358	5	35
5-630-21-D-1P	7311518189365	1	35
5-670-21-D-1P	7311518189389	1	35
500-12	7314150390977	1	270
500-14	7314150414505	1	270
500-15	7314150390984	1	270
500-16	7314150414512	1	270
500-18	7314150414543	1	270
500-22	7314150414567	1	270
502	7311518130589	25	566
502-SET2	7311518130664	35	566
502-SET6	7311518130633	10	566



5050	7314151083359	1	360
51-12	7311518044565	10	634
51-21	7311518003906	10	634
51-24	7311518003913	10	634
51-30	7311518003920	10	634
51-32	7311518003937	10	634
51-36	7311518003944	10	634
510031	7314150216338	5	215
510033	7314150216345	5	215
510034	7314150216314	10	214
5124-JS-H	7311518219352	4	635
5128-JS-H	7311518219369	4	635
52	7311518276027	12	308
5226 DC	7314150120352	1	248
527 D-160	7314150032723	5	236
527 D-200	7314150032730	5	236
527 GC-160	7314150205653	3	236
527 GC-200	7314150205660	3	236
527V-160	7314150126811	2	499
527V-200	7314150126828	2	499
528-700	7311518188993	1	573
528-COM	7311518188986	1	573
529-16-L	7314150198139	4	592
529-16-XL	7314150198146	4	592
529-20-L	7314150198160	4	592
529-20-XL	7314150198153	4	592
529S-16-XL	7314150340330	4	592
529S-20-XL	7314150340347	4	592
541 D-150	7314150032754	5	237
541 D-200	7314150032761	5	237
541 D-250	7314150032778	5	237
5418	7314151084370	1	536
5419/6T	7314151821562	1	536
541D-180	7314150127160	5	237
541D-225	7314150127290	5	237
5463 R	7314151085063	5	534
5463-120	7314151085001	5	534
54640	7314150215720	1	169
5465 AMT	7314151085148	5	532
5465 R	7314151085162	5	534
5468-112	7314151085247	5	532
5469 B	7314151085322	5	532
5469 BI	7314151085346	5	532
5469 I	7314151085407	5	532
5469 R	7314151085421	5	532
5469-127	7314151085285	5	532
5470-120	7314151085452	5	534
5471 F-120	7314151085681	5	532
5471 F-145	7314151085704	5	532
5471 F-200	7314151085728	5	532
5471 F-250	7314151085742	5	532
5471 F-300	7314151085766	5	532
5471 FI-120	7314151085780	5	532
5471 FI-200	7314151085827	5	532
5471 FR-120	7314151085889	5	532
5471 FR-145	7314151085902	5	532
5475 K	7314151086244	5	532
5475 R	7314151086268	5	532
5476 H	7314151086305	5	534
5479-130	7314151086398	5	532
5488 AM	7314151821166	5	533
5489 AM	7314151821173	5	533
5490 AM	7314151821180	5	533
5493-115	7314151821234	5	534
5515B	7314151086978	25	361
5515FL	7314150504077	10	361
5515FUV	7314150540143	1	361
5515GV	7314151481483	1	360
5515L	7314151481568	1	361
5515M	7314151086985	1	361
5515T	7314151589172	25	361
5515T-52	7314153021939	25	360
5516	7314151086992	5	532
5516 I	7314151087029	5	532
5517	7314151573843	5	532
5517 I	7314151573928	5	532
5518	7314151087043	5	532
5521	7314150215713	1	169
5540 AM	7314151821319	5	532
5541 AM	7314151821326	5	533
5544 AM	7314151821357	5	533
5545 AM	7314151821364	5	533
5546 AM	7314151821371	5	533
5547 AM	7314151821388	5	533
5549 AM	7314151821401	5	533
5550-3.2	7314151475673	10	536
5550-4.5	7314151475758	10	536
5551	7314151378479	1	536
5552	7314151378554	1	536
5553	7314151378639	1	536
5554	7314151378714	1	536
5568/5	7314151821210	1	534
5573-145	7314151473112	5	533
5577-145	7314151574062	5	534
5578-115	7314151547769	5	533
5579-115	7314151547844	5	533

5588 AM	7314151821432	5	534
5589 AM	7314151821449	5	534
5590 AM	7314151821456	5	534
5600/4	7314151436773	1	536
5724-JS	7311518216085	1	635
5728-JS	7311518216092	1	635
5750	7311518280949	1	343
5770	7314150504466	12	343
583D	7314150023721	4	577
584D	7314150023745	4	577
585D	7314150104185	4	577
586D	7314150104208	4	577
59/S100BC	7314150337637	1	167
59/S100BC-IP	7314150337644	8	167
59/S100CB	7314150413003	1	165
59/S28-4	7314151847173	1	166
59/S31B	7314150325788	1	166
59/S31B-IP	7314150325795	12	166
59/S35BC	7314150412990	1	167
59/S36BCR	7314150413232	6	211
59/S54BC	7314150337613	1	167
59/S54BC-IP	7314150337620	8	167
59S/0.5-3.0	7314150199815	1	160
59S/0.5-3.0-3P	7314150259205	1	160
59S/0.5-4.0	7314150199822	1	160
59S/0.5-4.0-3P	7314150259212	1	160
59S/0.6-3.5	7314150199839	1	160
59S/0.6-3.5-3P	7314150259229	1	160
59S/0.6-4.5	7314150198801	1	160
59S/0.6-4.5-3P	7314150201600	1	160
59S/0.8-5.5	7314150198849	1	160
59S/0.8-5.5-3P	7314150201624	1	160
59S/1.0-5.5	7314150198863	1	160
59S/1.0-5.5-3P	7314150259963	1	160
59S/1.2-6.5	7314150198887	1	160
59S/1.2-6.5-3P	7314150259970	1	160
59S/1.2-8.0	7314150198900	1	160
59S/1.2-8.0-3P	7314150259987	1	160
59S/1.6-10	7314150199846	1	160
59S/1.6-10-3P	7314150259236	1	160
59S/1.6-9.0	7314150199853	1	160
59S/1.6-9.0-3P	7314150259243	1	160
59S/125PH1	7314150206834	1	164
59S/125PH1-2P	7314150260553	1	164
59S/125PH2	7314150204298	1	164
59S/125PH2-2P	7314150260560	1	164
59S/125PH2-IP	7314150342433	100	164
59S/125PH3	7314150204304	1	164
59S/125PH3-2P	7314150260577	1	164
59S/125PZ1	7314150200733	1	164
59S/125PZ1-2P	7314150260522	1	164
59S/125PZ2	7314150200740	1	164
59S/125PZ2-2P	7314150260539	1	164
59S/125PZ3	7314150200757	1	164
59S/125PZ3-2P	7314150260546	1	164
59S/150T15	7314150200764	1	164
59S/150T15-2P	7314150260584	1	164
59S/150T20	7314150200771	1	164
59S/150T20-2P	7314150260591	1	164
59S/150T25	7314150200788	1	164
59S/150T25-2P	7314150260607	1	164
59S/150T30	7314150200795	1	164
59S/150T30-2P	7314150260614	1	164
59S/17-1	7314150191499	1	165
59S/17-2	7314150191505	1	166
59S/17-3	7314150191512	1	166
59S/22-1	7314150204229	1	166
59S/22-2	7314150204236	1	166
59S/31-1	7314150191451	1	166
59S/31-2	7314150191468	1	167
59S/31-3	7314150191475	1	167
59S/50/0.6-3.5	7314150199976	1	162
59S/50/0.8-4.0	7314150200009	1	162
59S/50/0.8-5.5	7314150200023	1	162
59S/50/1.0-6.0	7314150200047	1	162
59S/50/1.2-6.5	7314150200061	1	162
59S/50/3.5-2P	7314150260027	1	162
59S/50/4.0-2P	7314150260041	1	162
59S/50/5.5-2P	7314150260065	1	162
59S/50/6.0-2P	7314150260089	1	162
59S/50/6.5-2P	7314150260102	1	162
59S/50H1/16	7314150248926	1	163
59S/50H1/4	7314150249015	1	163
59S/50H1/8	7314150248964	1	163
59S/50H2	7314150200160	1	163
59S/50H2-2P	7314150259298	1	163
59S/50H2.5-5P	7314150531653	1	163
59S/50H2.5-2P	7314150259304	1	163
59S/50H3	7314150200184	1	163
59S/50H3-2P	7314150259335	1	163
59S/50H3/16	7314150248995	1	163
59S/50H3/32	7314150248940	1	163
59S/50H3/8	7314150249039	1	163
59S/50H4-5P	7314150531691	1	163
59S/50H4-2P	7314150259359	1	163
59S/50H5-5P	7314150531714	1	163



59S/50H5-2P



59S/50H5-2P	7314150259373	1	163
59S/50H5/16	7314150249022	1	163
59S/50H5/32	7314150248988	1	163
59S/50H5/64	7314150248933	1	163
59S/50H6	7314150200214	1	163
59S/50H6-2P	7314150259397	1	163
59S/50H7/32	7314150249008	1	163
59S/50H7/64	7314150248957	1	163
59S/50H8-2P	7314150259410	1	163
59S/50H8-5P	7314150531752	1	163
59S/50H9/64	7314150248971	1	163
59S/50PH1	7314150199860	1	162
59S/50PH1-2P	7314150203642	1	162
59S/50PH2-5P	7314150531790	1	162
59S/50PH2-2P	7314150203758	1	162
59S/50PH3-2P	7314150203802	1	162
59S/50PH3-5P	7314150531813	1	162
59S/50PZ1-2P	7314150204007	1	163
59S/50PZ2-2P	7314150204014	1	163
59S/50PZ2-5P	7314150531851	1	163
59S/50PZ3-2P	7314150204021	1	163
59S/50PZ3-5P	7314150531875	1	163
59S/50R1	7314150200238	1	163
59S/50R1-2P	7314150259441	1	163
59S/50R2	7314150200245	1	163
59S/50R2-2P	7314150259472	1	163
59S/50R3	7314150200252	1	163
59S/50R3-2P	7314150259502	1	163
59S/50T10	7314150200092	1	163
59S/50T10-2P	7314150201723	1	163
59S/50T15	7314150200108	1	163
59S/50T15-2P	7314150201730	1	163
59S/50T20-5P	7314150531936	1	163
59S/50T20-2P	7314150201747	1	163
59S/50T25	7314150200122	1	163
59S/50T25-2P	7314150201754	1	163
59S/50T27	7314150200139	1	163
59S/50T30	7314150200146	1	163
59S/50T30-2P	7314150201761	1	163
59S/50T40	7314150200153	1	163
59S/50T40-2P	7314150259281	1	163
59S/50T8	7314150200085	1	163
59S/50T8-2P	7314150262809	1	163
59S/60PEN/DISP	7314150459032	1	168
59S/7-1	7314150191536	1	165
59S/7-2	7314150191543	1	165
59S/7-3	7314150191550	1	165
59S/7-4	7314150191567	1	165
59S/70PH1-2P	7314150259526	1	163
59S/70PH2-2P	7314150259557	1	163
59S/70PH2-5P	7314150532032	1	163
59S/70PZ1	7314150200283	1	163
59S/70PZ1-2P	7314150259564	1	163
59S/70PZ2	7314150200290	1	163
59S/70PZ2-2P	7314150260331	1	163
59S/70PZ3	7314150200306	1	163
59S/70PZ3-2P	7314150260348	1	163
59S/70T10	7314150200313	1	163
59S/70T10-2P	7314150260355	1	163
59S/70T15	7314150200566	1	163
59S/70T15-2P	7314150260362	1	163
59S/70T20-2P	7314150201839	1	163
59S/70T20-5P	7314150532131	1	163
59S/70T25-2P	7314150260379	1	163
59S/70T25-5P	7314150532155	1	163
59S/70T27	7314150200597	1	163
59S/70T27-2P	7314150260386	1	163
59S/70T30-2P	7314150260393	1	163
59S/70T30-5P	7314150532179	1	163
59S/70T40	7314150200610	1	163
59S/70T40-2P	7314150260409	1	163
59S/70TR15	7314150200627	1	164
59S/70TR15-2P	7314150260416	1	164
59S/70TR20	7314150200634	1	164
59S/70TR20-2P	7314150260423	1	164
59S/70TR25	7314150200641	1	164
59S/70TR25-2P	7314150260430	1	164
59S/70TR27	7314150200658	1	164
59S/70TR27-2P	7314150260447	1	164
59S/70TR30	7314150200665	1	164
59S/70TR30-2P	7314150260454	1	164
59S/70TR40	7314150200672	1	164
59S/70TR40-2P	7314150260461	1	164
59S/H1.5	7314150198924	1	161
59S/H1.5-3P	7314150258994	1	161
59S/H1/16-3P	7314150259021	1	162
59S/H1/4	7314150199266	1	162
59S/H1/4-3P	7314150259120	1	162
59S/H1/8-3P	7314150259069	1	162
59S/H1/8-5P	7314150532254	1	162
59S/H10	7314150199075	1	161
59S/H10-3P	7311518333638	1	161
59S/H2	7314150198955	1	161
59S/H2-3P	7314150259007	1	161
59S/H2.5	7314150198962	1	161
59S/H2.5-3P	7314150259014	1	161



59S/H3	7314150198986	1	161
59S/H3-3P	7314150201662	1	161
59S/H3/16-3P	7314150259090	1	162
59S/H3/16-5P	7314150532353	1	162
59S/H3/32-3P	7314150259045	1	162
59S/H3/32-5P	7314150532377	1	162
59S/H3/8	7314150204212	1	162
59S/H3/8-3P	7314150259144	1	162
59S/H3BALL	7314150200689	1	164
59S/H3BALL-2P	7314150260478	1	164
59S/H4	7314150198993	1	161
59S/H4-3P	7314150201679	1	161
59S/H4-IPB	7314150225767	500	161
59S/H4BALL	7314150200696	1	164
59S/H4BALL-2P	7314150260485	1	164
59S/H5	7314150199013	1	161
59S/H5-3P	7314150201686	1	161
59S/H5/16-3P	7314150259137	1	162
59S/H5/16-5P	7314150532438	1	162
59S/H5/32-3P	7314150259083	1	162
59S/H5/32-5P	7314150532452	1	162
59S/H5/64-3P	7314150259038	1	162
59S/H5/64-5P	7314150532476	1	162
59S/H5BALL	7314150200702	1	164
59S/H5BALL-2P	7314150260492	1	164
59S/H6	7314150199037	1	161
59S/H6-3P	7314150201693	1	161
59S/H6BALL	7314150200719	1	164
59S/H6BALL-2P	7314150260508	1	164
59S/H7/32-3P	7314150259113	1	162
59S/H7/32-5P	7314150532513	1	162
59S/H7/64-3P	7314150259052	1	162
59S/H7/64-5P	7314150532537	1	162
59S/H8-3P	7314150201709	1	161
59S/H8-5P	7314150532551	1	161
59S/H8BALL	7314150200726	1	164
59S/H8BALL-2P	7314150260515	1	164
59S/H9/64-3P	7314150259076	1	162
59S/HBALL-3P	7314150201716	1	164
59S/M3	7314150199730	1	162
59S/M3-3P	7314150259151	1	162
59S/M4	7314150199754	1	162
59S/M4-3P	7314150259168	1	162
59S/M5	7314150199778	1	162
59S/M5-3P	7314150259175	1	162
59S/M6	7314150199792	1	162
59S/M6-3P	7314150259182	1	162
59S/M8	7314150199808	1	162
59S/M8-3P	7314150259199	1	162
59S/PH0	7314150198177	1	160
59S/PH0-3P	7314150258819	1	160
59S/PH1-30P	7314150200801	1	160
59S/PH1-3P	7314150201396	1	160
59S/PH1-IP	7314150206780	100	160
59S/PH1-IPB	7314150225743	500	160
59S/PH1COMBI-2P	7314150215669	1	164
59S/PH2	7314150198320	1	160
59S/PH2-30P	7314150200818	1	160
59S/PH2-3P	7314150201402	1	160
59S/PH2-IP	7314150206797	100	160
59S/PH2-IPB	7314150204038	500	160
59S/PH2COMBI-2P	7314150203604	1	164
59S/PH2G-30P	7314150200832	1	160
59S/PH2G-3P	7314150259250	1	160
59S/PH2PEN	7314150458950	1	168
59S/PH3-30P	7314150200825	1	160
59S/PH3-3P	7314150201419	1	160
59S/PH3-IPB	7314150225750	500	160
59S/PH3COMBI-2P	7314150203611	1	164
59S/PH4	7314150198368	1	160
59S/PH4-3P	7314150258826	1	160
59S/PZ0	7314150198375	1	161
59S/PZ0-3P	7314150258833	1	161
59S/PZ1	7314150198382	1	161
59S/PZ1-30P	7314150200849	1	161
59S/PZ1-3P	7314150201426	1	161
59S/PZ1-IP	7314150206803	100	161
59S/PZ1-IPB	7314150204373	500	161
59S/PZ2-30P	7314150200856	1	161
59S/PZ2-3P	7314150201433	1	161
59S/PZ2-IP	7314150206810	100	161
59S/PZ2-IPB	7314150204380	500	161
59S/PZ2PEN	7314150458974	1	168
59S/PZ3	7314150198429	1	161
59S/PZ3-30P	7314150200863	1	161
59S/PZ3-3P	7314150201440	1	161
59S/PZ3-IPB	7314150225736	500	161
59S/PZ4	7314150198436	1	161
59S/R1	7314150199310	1	162
59S/R1-3P	7314150201631	1	162
59S/R2	7314150199341	1	162
59S/R2-3P	7314150201648	1	162
59S/R3	7314150199365	1	162
59S/R3-3P	7314150201655	1	162
59S/R4	7314150232109	1	162
59S/T10	7314150198528	1	161



59S/T10-30P	7314150200870	1	161
59S/T10-3P	7314150201457	1	161
59S/T10CS	7314150444014	1	161
59S/T15-10P	7314150532759	1	161
59S/T15-30P	7314150200887	1	161
59S/T15-3P	7314150201464	1	161
59S/T15CS	7314150444021	1	161
59S/T15PEN	7314150458929	1	168
59S/T20-30P	7314150200894	1	161
59S/T20-3P	7314150201471	1	161
59S/T20CS	7314150444038	1	161
59S/T20PEN	7314150458936	1	168
59S/T25	7314150198566	1	161
59S/T25-30P	7314150200900	1	161
59S/T25-3P	7314150201488	1	161
59S/T25CS	7314150444045	1	161
59S/T25PEN	7314150458943	1	168
59S/T27	7314150198580	1	161
59S/T27-3P	7314150201495	1	161
59S/T27CS	7314150444052	1	161
59S/T3	7314150198443	1	161
59S/T3-3P	7314150258840	1	161
59S/T30-10P	7314150251988	1	161
59S/T30-30P	7314150200924	1	161
59S/T30-3P	7314150201501	1	161
59S/T30CS	7314150444069	1	161
59S/T4	7314150198450	1	161
59S/T4-3P	7314150258857	1	161
59S/T40	7314150198610	1	161
59S/T40-30P	7314150200931	1	161
59S/T40-3P	7314150201518	1	161
59S/T40CS	7314150444076	1	161
59S/T45-3P	7314150258918	1	161
59S/T45-5P	7314150532971	1	161
59S/T5	7314150198467	1	161
59S/T5-3P	7314150258864	1	161
59S/T50	7314150198658	1	161
59S/T50-3P	7314150258925	1	161
59S/T6	7314150198474	1	161
59S/T6-3P	7314150258871	1	161
59S/T7	7314150198498	1	161
59S/T7-3P	7314150258888	1	161
59S/T8	7314150198504	1	161
59S/T8-3P	7314150258895	1	161
59S/T9	7314150198511	1	161
59S/T9-3P	7314150258901	1	161
59S/TCS11-1	7314150444083	1	165
59S/TR10	7314150198702	1	161
59S/TR10-3P	7314150201525	1	161
59S/TR15	7314150198719	1	161
59S/TR15-3P	7314150201532	1	161
59S/TR20	7314150198726	1	161
59S/TR20-3P	7314150201549	1	161
59S/TR25	7314150198740	1	161
59S/TR25-3P	7314150201556	1	161
59S/TR27	7314150198757	1	161
59S/TR27-3P	7314150201570	1	161
59S/TR30	7314150198771	1	161
59S/TR30-3P	7314150201587	1	161
59S/TR40	7314150198795	1	161
59S/TR40-3P	7314150201594	1	161
59S/TR7	7314150198672	1	161
59S/TR7-3P	7314150258932	1	161
59S/TR8	7314150198689	1	161
59S/TR8-3P	7314150258949	1	161
59S/TR9	7314150198696	1	161
59S/TR9-3P	7314150258956	1	161
59S/TS-0	7314150199389	1	162
59S/TS-1	7314150199396	1	162
59S/TS-1/4	7314150199594	1	162
59S/TS-10-5P	7314150533138	1	162
59S/TS-2	7314150199419	1	162
59S/TS-3	7314150199433	1	162
59S/TS-4-5P	7314150533152	1	162
59S/TS-5-5P	7314150533176	1	162
59S/TS-6-5P	7314150533190	1	162
59S/TS-8-5P	7314150533220	1	162
59S/TW0	7314150199617	1	162
59S/TW1	7314150199631	1	162
59S/TW2	7314150199655	1	162
59S/TW3	7314150199679	1	162
59S/TW4	7314150199693	1	162
59S/TW5	7314150199716	1	162
6	8412814220048	1	218
6-342-06-2-0	7311518021719	10	30
6-342-06-2-2	7311518244170	5	30
6-342-08-1-0	7311518021726	10	30
6-342-08-1-2	7311518028282	5	30
6-342-08-2-0	7311518021733	10	30
6-342-08-2-2	7311518005375	5	30
6-342-10-1-0	7311518021757	10	30
6-342-10-1-2	7311518005382	5	30
6-342-10-2-0	7311518021764	10	30
6-342-10-2-2	7311518005399	5	30
6-343-08-2-0	7311518021801	10	30
6-343-08-2-2	7311518001070	5	30



6-343-08-3-0	7311518021818	10	30
6-343-10-2-0	7311518021825	10	30
6-343-10-2-2	7311518001094	5	30
6-343-10-3-0	7311518021832	10	30
6-344-08-2-0	7311518021887	10	30
6-344-08-2-2	7311518005344	5	30
6-344-10-2-0	7311518021900	10	30
6-344-10-2-2	7311518005351	5	30
6-345-08-1-2	7311518028312	5	31
6-345-08-2-0	7311518021948	10	31
6-345-08-2-2	7311518005412	5	31
6-345-10-1-2	7311518005429	5	31
6-345-10-2-0	7311518021955	10	31
6-470-08-2-2	7311518242008	5	31
600-3	7314150124787	1	208
600.003.010	8412814600000	1	372
600.005.012	8412814600017	1	372
601000800	8413345202299	1	589
601001000	8413345202305	1	589
601001250	8413345202312	1	589
601001500	8413345202329	1	589
6010H0800	8413345015769	1	590
6010H1000	8413345015776	1	590
6010H1250	8413345015783	1	590
6010H1500	8413345015790	1	590
6010M0800	8413345015806	1	589
6010M1000	8413345015813	1	589
6010M1250	8413345015820	1	589
6010M1500	8413345015837	1	589
601A	7314150476282	5	654
602-4-LA	7314150224357	1	208
604-5	7314150124800	1	208
6040M0630	8413345124126	1	590
605-10-PC-AU	7314150186334	1	209
605-6	7314150153770	1	209
606-6	7314150124824	1	209
6070H1000	8413345030656	1	589
6070H1250	8413345084833	1	589
6070H1500	8413345030663	1	589
6070H1750	8413345030670	1	589
607201000	8413345030533	1	589
607201250	8413345030540	1	589
607201500	8413345030557	1	589
607201750	8413345030564	1	589
6072M1000	8413345015813	1	589
6072M1500	8413345137454	1	589
6072M1750	8413345030687	1	589
60T/17-1	7314150191529	1	158
60T/31-1	7314150191482	1	158
60T/7-1	7314150191574	1	158
60T/PH1	7314150199488	1	158
60T/PH2	7314150199495	1	158
60T/PH3	7314150199501	1	158
60T/PZ1	7314150199525	1	158
60T/PZ2	7314150199549	1	158
60T/PZ3	7314150199563	1	158
60T/T15	7314150199662	1	158
60T/T20	7314150199686	1	158
60T/T25	7314150199709	1	158
60T/T27	7314150199723	1	158
60T/T40	7314150199761	1	158
60T/T7	7314150199587	1	158
60T/T9	7314150199624	1	158
610-6	7314150124848	1	209
611-10-200	7314150124428	10	210
611-3.5-100	7314150124336	10	210
611-3.5-75	7314150124329	10	210
611-4-100	7314150124350	10	210
611-4-75	7314150124343	10	210
611-5.5-100	7314150124367	10	210
611-5.5-125	7314150124381	10	210
611-6.5-125	7314150124374	10	210
611-6.5-150	7314150124398	10	210
611-6.5-25	7314150124602	10	210
611-8-150	7314150124404	10	210
611-8-175	7314150124411	10	210
612-5	7314150124817	1	208
613-3-100	7314150124442	10	210
613-3-75	7314150124435	10	210
613-3.5-100	7314150124459	10	210
613-4-100	7314150124466	10	210
613-4-125	7314150124473	10	210
613-5.5-150	7314150124497	10	210
613-6.5-150	7314150124503	10	210
614A	7314150476305	5	654
615-0-75	7314150124558	10	210
615-1-100	7314150124565	10	210
615-2-125	7314150124572	10	210
615-2-25	7314150124596	10	210
615-3-150	7314150124589	10	210
6151	7314150539185	10	652
6152	7314150539192	10	652
6152SS	7314150539215	10	652
6159	7314150539208	10	653
616-0-75	7314150124510	10	210
616-1-100	7314150124527	10	210





616-2-125	7314150124534	10	210
616-3-150	7314150124541	10	210
618-10-75	7314150124619	10	210
618-15-100	7314150124626	10	210
618-20-100	7314150124633	10	210
618-25-125	7314150124640	10	210
618-27-125	7314150124657	10	210
618-30-150	7314150124664	10	210
618-40-150	7314150124671	10	210
61H/50PH1	7314150200382	1	159
61H/50PZ1	7314150200412	1	159
61H/50PZ2	7314150200429	1	159
61H/50PZ3	7314150200436	1	159
61H/50T10	7314150200443	1	159
61H/50T15	7314150200450	1	159
61H/50T25	7314150200474	1	159
61H/50T30	7314150200481	1	159
61H/PH1	7314150199006	1	158
61H/PH2	7314150199020	1	158
61H/PH3	7314150199044	1	158
61H/PZ3	7314150199105	1	159
61H/T10	7314150199129	1	159
61H/T15	7314150199143	1	159
61H/T20	7314150199167	1	159
61H/T25	7314150199181	1	159
61H/T40	7314150199235	1	159
620-6	7314150128594	1	497
622-3P	7314150427727	1	248
6221D	7314150421596	10	248
6221D IP	7314150440368	10	248
6222D	7314150421589	10	248
6222D IP	7314150437702	10	248
6223D	7314150421558	8	248
6223D IP	7314150421794	8	248
6224	7314150421619	4	247
6224D	7314150421565	5	248
6224D IP	7314150421800	5	248
6225D	7314150421572	10	248
6225D IP	7314150421817	5	248
623-3-100	7314150128518	10	497
623-3.5-100	7314150128525	10	497
623-4-100	7314150128532	10	497
623-5.5-125	7314150128549	10	497
623-6.5-150	7314150128556	10	497
625	7311518221614	5	548
625-0-100	7314150128563	10	497
625-1-150	7314150128570	10	497
625-2-175	7314150128587	10	497
625-DROP	7311518221638	10	548
625-PEAR	7311518221621	10	548
625-ROUND	7311518221645	10	548
6258	7314150539222	10	653
62TIN/50PH1	7314150200504	1	157
62TIN/50PH3	7314150200528	1	157
62TIN/50PZ1	7314150200535	1	157
62TIN/50PZ2	7314150200542	1	157
62TIN/50PZ3	7314150200559	1	157
62TIN/7-1	7314150203505	1	157
62TIN/PH1	7314150199259	1	157
62TIN/PZ1	7314150199327	1	157
62TIN/PZ2	7314150199334	1	157
62TIN/PZ3	7314150199358	1	157
62TIN/T15	7314150199402	1	157
62TIN/T20	7314150199426	1	157
62TIN/T25	7314150199440	1	157
62TIN/T30	7314150199464	1	157
63D/50PZ1	7314150200320	1	157
63D/50PZ2	7314150200337	1	157
63D/50PZ3	7314150200344	1	157
63D/7-1	7314150191604	1	157
63D/PH2G	7314150198979	1	156
63D/PH3	7314150198948	1	156
63D/PZ1	7314150198856	1	156
63D/PZ2	7314150198870	1	156
63D/T10	7314150198665	1	156
63D/T15	7314150198733	1	156
63D/T40	7314150198832	1	156
64A/PH1	7314150198481	1	157
64A/PH3	7314150198573	1	157
64A/PZ1	7314150198603	1	158
64A/PZ3	7314150198634	1	158
650	7311518221591	5	548
65I/7-1	7314150204113	1	529
65I/PH1	7314150199785	1	529
65I/PH1-2P	7314150207985	1	529
65I/PH2	7314150199884	1	529
65I/PH2-2P	7314150201259	1	529
65I/PH3	7314150199907	1	529
65I/PH3-2P	7314150201266	1	529
65I/PZ1	7314150199921	1	529
65I/PZ1-2P	7314150201273	1	529
65I/PZ2	7314150199945	1	529
65I/PZ2-2P	7314150201280	1	529
65I/PZ3	7314150199969	1	529
65I/PZ3-2P	7314150201297	1	529
65I/T15	7314150199990	1	529



65I/T25	7314150200030	1	529
65I/T30	7314150200054	1	529
65I/T40	7314150200078	1	529
65I/T40-2P	7314150201358	1	529
665	7311518221607	5	548
66IM/10C-1	7314150450732	1	160
66IM/11C-1	7314150450718	1	160
66IM/50PH1-2P	7314150446056	1	159
66IM/50PH2-2P	7314150446063	1	159
66IM/50PH3-2P	7314150446087	1	159
66IM/50PZ1-2P	7314150446094	1	160
66IM/50PZ2-2P	7314150446100	1	160
66IM/50PZ3-2P	7314150446117	1	160
66IM/50T10C-2P	7314150446131	1	160
66IM/50T15C-2P	7314150446148	1	160
66IM/50T20C-2P	7314150446155	1	160
66IM/50T25C-2P	7314150446162	1	160
66IM/50T27C-2P	7314150446179	1	160
66IM/50T30C-2P	7314150446186	1	160
66IM/50T40C-2P	7314150446193	1	160
66IM/PH1-2P	7314150445929	1	159
66IM/PH2-2P	7314150445936	1	159
66IM/PH3-2P	7314150445943	1	159
66IM/PZ1-2P	7314150445950	1	159
66IM/PZ2-2P	7314150445967	1	159
66IM/PZ3-2P	7314150445974	1	159
66IM/T10C-2P	7314150445981	1	159
66IM/T15C-2P	7314150445998	1	159
66IM/T20C-2P	7314150446001	1	159
66IM/T25C-2P	7314150446018	1	159
66IM/T27C-2P	7314150446025	1	159
66IM/T30C-2P	7314150446032	1	159
66IM/T40C-2P	7314150446049	1	159
6700SM-10	7314151088026	5	78
6700SM-11	7314151088033	5	78
6700SM-12	7314151088040	5	78
6700SM-13	7314151088057	5	78
6700SM-14	7314151088064	5	78
6700SM-4	7314151087944	5	78
6700SM-4.5	7314151087951	5	78
6700SM-5	7314151087968	5	78
6700SM-5.5	7314151087975	5	78
6700SM-6	7314151087982	5	78
6700SM-7	7314151087999	5	78
6700SM-8	7314151088002	5	78
6700SM-9	7314151088019	5	78
6700SZ-1/2	7314151088194	5	78
6700SZ-1/4	7314151088132	5	78
6700SZ-1/8	7314150346349	5	78
6700SZ-11/32	7314151088163	5	78
6700SZ-3/16	7314151088118	5	78
6700SZ-3/8	7314151088170	5	78
6700SZ-5/16	7314151088156	5	78
6700SZ-5/32	7314151808556	5	78
6700SZ-7/16	7314151088187	5	78
6700SZ-7/32	7314151088125	5	78
6700SZ-9/16	7314151088200	5	78
6700SZ-9/32	7314151088149	5	78
6700TORX-E10	7314153011725	5	78
6700TORX-E4	7314153011671	5	78
6700TORX-E5	7314153011688	5	78
6700TORX-E6	7314153011695	5	78
6700TORX-E7	7314153011701	5	78
6700TORX-E8	7314153011718	5	78
6706TE	7314150220199	1	69
6708DMB	7314150220205	1	69
6709-IP10	7314150354498	1	83
6709-IP15	7314150354504	1	83
6709-IP20	7314150354511	1	83
6709-IP25	7314150354528	1	83
6709-IP27	7314150354535	1	83
6709-IP30	7314150354542	1	83
6709-IP40	7314150354559	1	83
6709-IP45	7314150354566	1	83
6709-IP6	7314150460373	1	83
6709-IP7	7314150460366	1	83
6709-IP8	7314150460359	1	83
6709-IP9	7314150460342	1	83
6709F-4.5	7314151830762	5	82
6709F-5.5	7314151830779	5	82
6709F-6.5	7314150220397	5	82
6709F-8	7314151830786	5	82
6709HL	7314150128457	1	81
6709M-10	7314150430833	5	83
6709M-3	7314151830656	5	83
6709M-4	7314151830663	5	83
6709M-5	7314151830670	5	83
6709M-6	7314151830687	5	83
6709M-8	7314151830694	5	83
6709PH-1	7314151830700	5	82
6709PH-2	7314151830717	5	82
6709PH-3	7314151830724	5	82
6709PZ-1	7314151830731	5	82
6709PZ-2	7314151830748	5	82
6709PZ-3	7314151830755	5	82
6709TORX-R-T10	7314153002471	1	83



6709TORX-R-T15	7314153002488	1	83
6709TORX-R-T20	7314153002495	1	83
6709TORX-R-T25	7314153002501	1	83
6709TORX-R-T8	7314153002464	1	83
6709TORX-T10	7314151811679	5	83
6709TORX-T15	7314151811686	5	83
6709TORX-T20	7314151811693	5	83
6709TORX-T25	7314151811709	5	83
6709TORX-T27	7314151811716	5	83
6709TORX-T30	7314151811723	5	83
6709TORX-T40	7314153002457	5	83
6709TORX-T6	7314150460540	5	83
6709TORX-T7	7314150460557	5	83
6709TORX-T8	7314153002440	5	83
6709TORX-T9	7314151811662	5	83
671002600	8413345128971	50	553
671002850	8413345128988	1	553
6711MB	7314150220298	1	69
6712R	7314151838225	1	65
6712RN	7314151838232	1	65
6713MH	7314150220212	1	68
6715GE	7314151831370	1	67
6715GJ	7314151831363	1	67
6715MG	7314151831349	1	66
6715MGS	7314151831332	1	65
6715MZ	7314153003218	1	68
6715PZ	7314151837525	1	67
6717MBP	7314150218806	1	66
6719MHR	7314150218783	1	65
6719SM	7314151820817	1	66
6720NM	7314151088262	1	67
6721NM	7314151088309	1	66
6722M	7314151594411	1	67
6729MHP	7314150218752	1	66
6729MHR	7314150218769	1	65
6729SM	7314153003225	1	68
6729SZ	7314153003232	1	68
6730MBP	7314150218776	1	66
677-10	7314150362486	1	51
677-13	7314150362493	1	51
677-3/8	7314150362509	1	51
677-7	7314150362455	1	51
677-8	7314150362462	1	51
677-9	7314150362479	1	51
679-1/2	7314150363384	1	54
679-10	7314150357345	1	54
679-11	7314150357352	1	54
679-12	7314150357369	1	54
679-13	7314150357376	1	54
679-14	7314150357383	1	54
679-3/8	7314150363360	1	54
679-7	7314150357536	1	54
679-7/16	7314150363377	1	54
679-8	7314150357079	1	54
679-9	7314150357338	1	54
679-9/16	7314150363391	1	54
6821NZ	7314151089269	1	68
6852-5	7314150125463	1	111
6852-5/S17	7314150135875	1	112
6852P-5	7314150416585	1	112
6876N	7314151845575	1	112
6878N	7314151845582	1	112
6880N	7314151845599	1	112
690000160	8413345008068	1	610
690000200	8413345008082	1	610
690000220	8413345008099	1	610
690000250	8413345008105	1	610
690000300	8413345008129	1	610
690000320	8413345087476	1	610
690000350	8413345008136	1	610
690000400	8413345008143	1	610
690000500	8413345008167	1	610
690000630	8413345111065	1	610
69079019P	8413345111089	1	610
690900080	8413345016209	4	610
690900100	8413345016216	4	610
690900120	8413345016223	2	610
690900140	8413345016230	2	610
690900200	8413345016247	1	610
6950	7314151089641	1	84
6950-SPARE	7314150187867	1	85
6950RN	7314151831189	1	84
6950RN-SPARE	7314150209149	1	85
6950SL	7314150197668	1	84
6950SL-SPARE	7314150210251	1	85
6951	7314151089764	1	84
6954	7314151089795	1	80
6956	7314151089825	10	80
6958-6	7314150476329	1	80
6960	7314151089856	1	81
6960-3	7314150489381	10	81
6960F-6	7314150489206	20	81
6960W-2	7314150470860	10	81
6960W-4	7314150470877	1	81
6960W-6	7314150470884	10	81
6961	7314151089870	1	81



6962	7314151089894	1	81
6962L	7314151089917	1	81
6966	7314151089986	10	81
6968	7314150128426	1	81
6969	7314150489268	1	82
696EX-01	7314150386192	1	81
696EX-06	7314150386239	1	81
696EX-08	7314150386246	1	81
696EX-11	7314150386208	1	81
6972H	7314151215934	5	81
6973A	7314150339495	10	82
6973M	7314150339501	1	81
6973N	7314151845605	1	111
6976N	7314151845612	1	111
6978N	7314151845629	1	111
6M-10-11	7314151832094	10	48
6M-10-13	7314151832117	10	48
6M-12-13	7314151832131	10	48
6M-12-14	7314151832148	10	48
6M-13-14	7314151832155	10	48
6M-13-15	7314151832162	10	48
6M-13-16	7314151832179	10	48
6M-13-17	7314151832186	10	48
6M-14-15	7314151832193	10	48
6M-14-17	7314151832209	10	48
6M-16-17	7314151832216	10	48
6M-16-18	7314151832223	10	48
6M-17-19	7314151832230	10	48
6M-18-19	7314151832247	10	48
6M-19-22	7314151832261	10	48
6M-19-24	7314151832278	10	48
6M-20-22	7314151832285	10	48
6M-21-23	7314151832292	10	48
6M-21-24	7314151838072	10	48
6M-22-24	7314151832308	10	48
6M-24-26	7314151832315	10	48
6M-24-27	7314151832322	10	48
6M-24-30	7314151832339	5	48
6M-25-28	7314151832353	5	48
6M-27-29	7314150189861	5	48
6M-27-30	7314151832360	5	48
6M-27-32	7314151832377	5	48
6M-30-32	7314151832384	5	48
6M-30-36	7314151832407	5	48
6M-32-36	7314151832414	5	48
6M-34-36	7314151832421	1	48
6M-36-41	7314151832438	1	48
6M-38-42	7314151832445	1	48
6M-4-5	7314151832018	10	48
6M-4-5-5.5	7314151832025	10	48
6M-41-46	7314151832452	1	48
6M-46-50	7314151832469	1	48
6M-5-5.5	7314151832032	10	48
6M-5-5-7	7314151832049	10	48
6M-6-7	7314151832056	10	48
6M-7-8	7314151832063	10	48
6M-8-10	7314151832087	10	48
6M-8-9	7314151832070	10	48
6M/10C	7314150212934	1	50
6M/12C	7314150212941	1	50
6M/6C	7314150212910	1	50
6M/8C	7314150212927	1	50
6M/S8	7314151832483	1	49
6M/SH12	7314153013439	1	49
6M/SH8	7314150201365	1	49
6MV-10	7314150120871	5	501
6MV-11	7314150120888	5	501
6MV-12	7314150120895	5	501
6MV-13	7314150120901	5	501
6MV-14	7314150120918	5	501
6MV-15	7314150120925	5	501
6MV-16	7314150120932	5	501
6MV-17	7314150120949	3	501
6MV-18	7314150120956	3	501
6MV-19	7314150120963	3	501
6MV-20	7314150120970	3	501
6MV-21	7314150120987	3	501
6MV-22	7314150120994	3	501
6MV-23	7314150121001	3	501
6MV-24	7314150121014	3	501
6MV-27	7314150121021	2	501
6MV-30	7314150121038	2	501
6MV-32	7314150121052	2	501
6MV-6	7314150120833	5	501
6MV-7	7314150120840	5	501
6MV-8	7314150120857	5	501
6MV-9	7314150120864	5	501
6MV/10T	7314150213023	1	504
6MV/8T	7314150122141	1	504
6Z-1-1.1/8	7314151832674	1	49
6Z-1.1/16-1.1/4	7314151832681	1	49
6Z-1.1/4-1.3/8	7314151832698	1	49
6Z-1/2-9/16	7314151832568	5	49
6Z-1/4-5/16	7314151832520	5	49
6Z-11/16-3/4	7314151832612	5	49
6Z-13/16-7/8	7314151832643	5	49





6Z-15/16-1	7314151832667	5	49
6Z-19/32-11/16	7314151832582	5	49
6Z-25/32-13/16	7314151832636	5	49
6Z-3/4-7/8	7314151832629	5	49
6Z-3/8-7/16	7314151832544	5	49
6Z-5/16-11/32	7314151832537	5	49
6Z-5/8-3/4	7314151832605	5	49
6Z-7/16-1/2	7314151832551	5	49
6Z-7/8-15/16	7314151832650	5	49
6Z-9/16-5/8	7314151832575	5	49
6Z/8C	7314150212958	1	50
700-1-50	7314153017673	5	213
700-1.2-50	7314153017680	5	213
700-1.5-50	7314153017697	5	213
700-1.8-50	7314153017703	5	213
700-2-50	7314153017710	5	213
700-2.5-50	7314153017741	5	213
700-3-100	7314153017772	5	213
700-3-200	7314153017789	5	213
700-3-50	7314153017765	5	213
700-3.5-75	7314153017796	5	213
700-4-250	7314153017819	5	213
700-4-75	7314153017802	5	213
701-0-200	7314153017857	5	214
701-0-50	7314153017840	5	214
701-00-50	7314153017833	5	214
701-1-250	7314153017871	5	214
701-1-75	7314153017864	5	214
702-0-50	7314153017888	5	214
702-1-75	7314153017895	5	214
703-10-50	7314153017963	5	214
703-15-75	7314153017970	5	214
703-20-75	7314153017987	5	214
703-4-50	7314153017901	5	214
703-5-50	7314153017918	5	214
703-6-50	7314153017925	5	214
703-7-50	7314153017932	5	214
703-8-50	7314153017949	5	214
703-9-50	7314153017956	5	214
704-1.5-50	7314153017994	5	214
704-2-50	7314153018007	5	214
704-2.5-50	7314153018014	5	214
704-3-75	7314153018021	5	214
704Z-3/32	7314150137428	5	214
706-1	7314153018045	1	212
706-2	7314153018052	1	212
706-3	7314153018069	1	213
706-4	7314153018076	1	213
706-5	7314153018083	1	213
70S/1.2-8.0-2P	7314150262823	1	168
70S/1.6-10.0	7314150218394	1	168
70S/1.6-10.0-2P	7314150261017	1	168
70S/1.6-9.0	7314150218400	1	168
70S/1.6-9.0-2P	7314150261024	1	168
70S/2.0-12.0	7314150218417	1	169
70S/2.0-12.0-2P	7314150261086	1	169
70S/2.5-14.0	7314150218424	1	169
70S/2.5-14.0-2P	7314150261147	1	169
70S/H10	7314150218486	1	169
70S/H10-2P	7314150261451	1	169
70S/H12	7314150218493	1	169
70S/H12-2P	7314150261468	1	169
70S/H14	7314150218509	1	169
70S/H14-2P	7314150261475	1	169
70S/H4	7314150218431	1	169
70S/H4-2P	7314150261352	1	169
70S/H5	7314150218448	1	169
70S/H5-2P	7314150261406	1	169
70S/H6	7314150218455	1	169
70S/H6-2P	7314150261437	1	169
70S/H7	7314150218462	1	169
70S/H7-2P	7314150261444	1	169
70S/H8-5P	7314150538782	1	169
70S/H8-2P	7314150262847	1	169
70S/PH1	7314150217557	1	169
70S/PH1-2P	7314150260621	1	169
70S/PH2	7314150217564	1	169
70S/PH2-2P	7314150260638	1	169
70S/PH3	7314150217571	1	169
70S/PH3-2P	7314150260645	1	169
70S/PH4	7314150217588	1	169
70S/PH4-2P	7314150260652	1	169
70S/PZ1	7314150217595	1	169
70S/PZ1-2P	7314150260683	1	169
70S/PZ2	7314150217601	1	169
70S/PZ2-2P	7314150260706	1	169
70S/PZ3	7314150217724	1	169
70S/PZ3-2P	7314150260720	1	169
70S/PZ4	7314150217731	1	169
70S/PZ4-2P	7314150260737	1	169
70S/T20	7314150217748	1	169
70S/T20-2P	7314150260744	1	169
70S/T25-2P	7314150260812	1	169
70S/T25-5P	7314150538508	1	169
70S/T27-5P	7314150538522	1	169
70S/T27-2P	7314150260867	1	169



70S/T30	7314150217779	1	169
70S/T30-2P	7314150260881	1	169
70S/T40-2P	7314150260898	1	169
70S/T45	7314150217793	1	169
70S/T45-2P	7314150260904	1	169
70S/T50	7314150217809	1	169
70S/T50-2P	7314150260911	1	169
70S/T55	7314150217816	1	169
70S/T55-2P	7314150260928	1	169
70S/TS1/4	7314150218349	1	169
70S/TS1/4-2P	7314150260935	1	169
70S/TS10	7314150218356	1	169
70S/TS10-2P	7314150260942	1	169
70S/TS5/16	7314150218363	1	169
70S/TS5/16-2P	7314150260959	1	169
70S/TS8	7314150218370	1	169
70S/TS8-2P	7314150260966	1	169
7106J	7314150339518	1	88
7154TC	7314150475148	10	649
7190	7314150052479	10	644
7190 CO	7314150052790	10	644
7191	7314150052509	10	644
7191 CO	7314150052806	10	644
7223	7314150237722	4	247
7223D	7314150421527	8	247
7223D IP	7314150440306	8	247
7223IP	7314150421855	8	247
7224	7311518274733	4	247
7224-622XD-3P	7314150426973	1	249
7224IP	7314150421831	4	247
7224S	7314150421657	4	501
7225	7314150237739	8	247
7225D	7314150421541	4	247
7225D IP	7314150440320	4	247
7225IP	7314150421848	4	247
7280	7314150052523	10	647
7285	7314150052530	10	647
7290	7314150052547	10	645
7291	7314150052554	10	645
7292	7314150052578	10	646
7292G	7314150434701	10	648
7293	7314150052592	10	646
7372L-2-63	7314151398668	10	218
7372L-2.5-75	7314151399047	10	218
7372L-3-80	7314151341602	10	218
7400SM-10	7314151092955	5	85
7400SM-11	7314151092962	5	85
7400SM-12	7314151092979	5	85
7400SM-13	7314151092986	5	85
7400SM-14	7314151092993	5	85
7400SM-15	7314151093006	5	85
7400SM-16	7314151831127	5	85
7400SM-17	7314151093020	5	85
7400SM-18	7314151831134	5	85
7400SM-19	7314151093044	5	85
7400SM-20	7314153002570	5	85
7400SM-21	7314153002587	5	85
7400SM-22	7314153002594	5	85
7400SM-6	7314151092917	5	85
7400SM-7	7314151092924	5	85
7400SM-8	7314151092931	5	85
7400SM-9	7314151092948	5	85
7400SR/S12	7314153003294	1	71
7400SZ-1/2	7314150385942	1	85
7400SZ-1/4	7314150385959	1	85
7400SZ-11/16	7314150385966	1	85
7400SZ-11/32	7314150385973	1	85
7400SZ-13/16	7314150385980	1	85
7400SZ-3/4	7314150385997	1	85
7400SZ-3/8	7314150386000	1	85
7400SZ-5/16	7314150386017	1	85
7400SZ-5/8	7314150386024	1	85
7400SZ-7/16	7314150386031	1	85
7400SZ-7/8	7314150386048	1	85
7400SZ-9/16	7314150386055	1	85
7400TORX-E10	7314153003058	5	86
7400TORX-E11	7314153003065	5	86
7400TORX-E12	7314153003072	5	86
7400TORX-E14	7314153003089	5	86
7400TORX-E16	7314153003096	5	86
7400TORX-E18	7314153003102	5	86
7400TORX-E8	7314150118243	5	86
7400TORX-ER/S7	7314153003300	1	71
7402GPR-16	7314150503087	120	307
7402GPR-18	7314150503094	120	307
7402GPR-21	7314150503100	100	307
7406ZZ-16	7314153011992	1	307
7406ZZ-21	7314153012005	1	307
7407H	7314151218249	1	173
7408H	7314151218300	1	173
7408MD	7314150220328	1	71
7409BH-10	7314153002112	5	90
7409BH-4	7314153002075	5	90
7409BH-5	7314153002082	1	90
7409BH-6	7314153002099	5	90
7409BH-8	7314153002105	5	90



7409F-10	7314153002143	5	89
7409F-6.5	7314153002129	5	89
7409F-8	7314153002136	5	89
7409H	7314151218355	173	89
7409M-10	7314153001962	5	90
7409M-3	7314153002235	5	90
7409M-4	7314153001900	5	90
7409M-5	7314153001917	5	90
7409M-6	7314153001924	5	90
7409M-7	7314153001931	5	90
7409M-8	7314153001948	5	90
7409MB	7314150220236	1	71
7409MR/S7	7314153003256	1	90
7409PH-1	7314153002150	5	89
7409PH-2	7314153002167	5	89
7409PH-3	7314153002174	5	89
7409TORX-R-T27	7314153001856	5	89
7409TORX-R-T30	7314153001863	5	89
7409TORX-R-T40	7314153001870	5	89
7409TORX-R-T45	7314153001887	5	89
7409TORX-R-T50	7314153001894	5	89
7409TORX-T20	7314150220403	5	89
7409TORX-T25	7314153001771	5	89
7409TORX-T25-L	7314153011237	5	90
7409TORX-T27	7314153001788	5	89
7409TORX-T30	7314153001795	5	89
7409TORX-T30-L	7314153011244	5	90
7409TORX-T40	7314153001801	5	89
7409TORX-T40-L	7314153011251	5	90
7409TORX-T45	7314153001818	5	89
7409TORX-T45-L	7314153011268	5	90
7409TORX-T50	7314153001825	5	89
7409TORX-T50-L	7314153011275	5	90
7409TORX-TRR/S5	7314153003263	1	89
7409Z-1/4	7314150386062	1	90
7409Z-1/8	7314150386079	1	90
7409Z-3/16	7314150386086	1	90
7409Z-3/8	7314150386093	1	90
7409Z-5/32	7314150386109	1	90
7409Z-7/32	7314150386116	1	90
7422MBR	7314150218844	1	71
7422MHR	7314150218868	1	71
7444SG-M-100	7314151830014	1	55
7444SG-M-105	7314151830021	1	55
7444SG-M-110	7314151830038	1	55
7444SG-M-115	7314151830045	1	55
7444SG-M-120	7314151830052	1	55
7444SG-M-125	7314151830069	1	55
7444SG-M-130	7314151830076	1	55
7444SG-M-135	7314151830083	1	55
7444SG-M-140	7314151830090	1	55
7444SG-M-145	7314151830106	1	55
7444SG-M-150	7314151830113	1	55
7444SG-M-155	7314151830120	1	55
7444SG-M-160	7314150132508	1	55
7444SG-M-165	7314150132515	1	55
7444SG-M-170	7314150132522	1	55
7444SG-M-175	7314150132539	1	55
7444SG-M-24	7314150205400	1	55
7444SG-M-27	7314151829834	1	55
7444SG-M-30	7314151829841	1	55
7444SG-M-32	7314151829858	1	55
7444SG-M-34	7314151838560	1	55
7444SG-M-36	7314151829865	1	55
7444SG-M-38	7314150180936	1	55
7444SG-M-41	7314151829872	1	55
7444SG-M-42	7314151829889	1	55
7444SG-M-46	7314151829896	1	55
7444SG-M-50	7314151829919	1	55
7444SG-M-55	7314151829926	1	55
7444SG-M-60	7314151829933	1	55
7444SG-M-65	7314151829940	1	55
7444SG-M-70	7314151829957	1	55
7444SG-M-75	7314151829964	1	55
7444SG-M-80	7314151829971	1	55
7444SG-M-85	7314151829988	1	55
7444SG-M-90	7314151829995	1	55
7444SG-M-95	7314151830007	1	55
7444SG-Z-1.1/16	7314150132546	1	55
7444SG-Z-1.1/2	7314150132614	1	55
7444SG-Z-1.1/4	7314150132577	1	55
7444SG-Z-1.1/8	7314150132553	1	55
7444SG-Z-1.11/16	7314150132638	1	55
7444SG-Z-1.13/16	7314150132652	1	55
7444SG-Z-1.3/16	7314150132560	1	55
7444SG-Z-1.3/4	7314150132645	1	55
7444SG-Z-1.3/8	7314150132591	1	55
7444SG-Z-1.5/16	7314150132584	1	55
7444SG-Z-1.5/8	7314150132621	1	55
7444SG-Z-1.7/16	7314150132607	1	55
7444SG-Z-1.7/8	7314150132669	1	55
7444SG-Z-2	7314150132676	1	55
7444SG-Z-2.1/16	7314150132683	1	55
7444SG-Z-2.1/4	7314150132713	1	55
7444SG-Z-2.1/8	7314150132690	1	55
7444SG-Z-2.3/16	7314150132706	1	55



7444SG-Z-2.3/4	7314150132768	1	55
7444SG-Z-2.3/8	7314150132720	1	55
7444SG-Z-2.5/8	7314150132751	1	55
7444SG-Z-2.9/16	7314150132744	1	55
7444SG-Z-3	7314150132775	1	55
7444SG-Z-3.1/2	7314150132805	1	55
7444SG-Z-3.1/8	7314150132782	1	55
7444SG-Z-3.3/4	7314150132812	1	55
7444SG-Z-3.3/8	7314150132799	1	55
7444SG-Z-3.7/8	7314150132829	1	55
7444SG-Z-4	7314150132836	1	55
7444SG-Z-4.1/2	7314150132850	1	55
7444SG-Z-4.1/8	7314150132843	1	55
7454-1400	7314150119592	1	109
7454-1400E	7314150119615	1	109
7454-140A	7314150509515	1	108
7454-17	7314150509492	1	108
7454-230	7314150509522	1	108
7454-3.5	7314150509478	1	108
7454-32	7314150509508	1	108
7454-480	7314150119578	1	109
7454-70A	7314150509577	1	108
7454-8.4	7314150509485	1	108
7454-800A	7314150509584	1	108
7454-800E	7314150119608	1	109
7455-100	7314150125111	1	106
7455-1000	7314150368303	1	106
7455-100A	7314150340156	1	106
7455-15	7314150119646	1	106
7455-1500	7314150125166	1	107
7455-20	7314150125074	1	106
7455-200	7314150125128	1	106
7455-25	7314150125081	1	106
7455-2500	7314150125173	1	107
7455-300	7314150125104	1	106
7455-340	7314150125135	1	106
7455-5	7314150119639	1	106
7455-500	7314150125142	1	106
7455-60	7314150125098	1	106
7455-800	7314150125159	1	106
7456-80LB	7314150119783	1	107
7465-100	7314150340200	1	107
7465-15	7314150340170	1	107
7465-1500	7314150340248	1	107
7465-200	7314150340217	1	107
7465-30	7314150340187	1	107
7465-340	7314150340224	1	107
7465-5	7314150340163	1	107
7465-60	7314150340194	1	107
7465-800	7314150340231	1	107
747-1	7314150362899	1	51
747-1.1/16	7314150362905	1	51
747-1.1/2	7314150362974	1	51
747-1.1/4	7314150362936	1	51
747-1.1/8	7314150362912	1	51
747-1.11/16	7314150363001	1	51
747-1.13/16	7314150363025	1	51
747-1.15/16	7314150363049	1	51
747-1.3/16	7314150362929	1	51
747-1.3/4	7314150363018	1	51
747-1.3/8	7314150362950	1	51
747-1.5/16	7314150362943	1	51
747-1.5/8	7314150362998	1	51
747-1.7/16	7314150362967	1	51
747-1.7/8	7314150363032	1	51
747-1.9/16	7314150362981	1	51
747-1/2	7314150362813	1	51
747-10	7314150362516	1	51
747-11	7314150362523	1	51
747-11/16	7314150362844	1	51
747-12	7314150362530	1	51
747-13	7314150362547	1	51
747-13/16	7314150362868	1	51
747-14	7314150362554	1	51
747-15	7314150362561	1	51
747-15/16	7314150362882	1	51
747-16	7314150362578	1	51
747-17	7314150362585	1	51
747-18	7314150362592	1	51
747-19	7314150362608	1	51
747-2	7314150363056	1	51
747-2.1/16	7314150363063	1	51
747-2.1/2	7314150363131	1	51
747-2.1/4	7314150363094	1	51
747-2.1/8	7314150363070	1	51
747-2.3/16	7314150364893	1	51
747-2.3/4	7314150363162	1	51
747-2.3/8	7314150363117	1	51
747-2.5/16	7314150363100	1	51
747-2.5/8	7314150363155	1	51
747-2.7/16	7314150363124	1	51
747-2.7/8	7314150363179	1	51
747-2.9/16	7314150363148	1	51
747-20	7314150362615	1	51
747-21	7314150362622	1	51
747-22	7314150362639	1	51





747-23	7314150362646	1	51
747-24	7314150362653	1	51
747-25	7314150362660	1	51
747-26	7314150362677	1	51
747-27	7314150362684	1	51
747-28	7314150362691	1	51
747-3/4	7314150362851	1	51
747-3/8	7314150362790	1	51
747-30	7314150362707	1	51
747-32	7314150362714	1	51
747-34	7314150362721	1	51
747-36	7314150362738	1	51
747-40	7314150362745	1	51
747-41	7314150362752	1	51
747-42	7314150362769	1	51
747-46	7314150362776	1	51
747-5/8	7314150362837	1	51
747-50	7314150362783	1	51
747-7/16	7314150362806	1	51
747-7/8	7314150362875	1	51
747-9/16	7314150362820	1	51
749-1	7314150363506	1	54
749-1.1/16	7314150363513	1	54
749-1.1/2	7314150363582	1	54
749-1.1/4	7314150363544	1	54
749-1.1/8	7314150363520	1	54
749-1.11/16	7314150363612	1	54
749-1.13/16	7314150363636	1	54
749-1.15/16	7314150363650	1	54
749-1.3/16	7314150363537	1	54
749-1.3/4	7314150363629	1	54
749-1.3/8	7314150363568	1	54
749-1.5/16	7314150363551	1	54
749-1.5/8	7314150363605	1	54
749-1.7/16	7314150363575	1	54
749-1.7/8	7314150363643	1	54
749-1.9/16	7314150363599	1	54
749-1/2	7314150363421	1	54
749-10	7314150538386	10	54
749-11	7314150538362	10	54
749-11/16	7314150363452	1	54
749-13	7314150538348	10	54
749-13/16	7314150363476	1	54
749-14	7314150538324	10	54
749-15	7314150357543	1	54
749-15/16	7314150363490	1	54
749-16	7314150357550	1	54
749-17	7314150357567	1	54
749-18	7314150357574	1	54
749-19	7314150357581	1	54
749-2	7314150363667	1	54
749-2.1/4	7314150363698	1	54
749-2.1/8	7314150363674	1	54
749-2.3/16	7314150363681	1	54
749-2.3/4	7314150363728	1	54
749-2.3/8	7314150363704	1	54
749-2.5/8	7314150363711	1	54
749-20	7314150357598	1	54
749-21	7314150357604	1	54
749-22	7314150357611	1	54
749-23	7314150357628	1	54
749-24	7314150357635	1	54
749-25	7314150357642	1	54
749-26	7314150357659	1	54
749-27	7314150357666	1	54
749-3.1/8	7314150363735	1	54
749-3/4	7314150363469	1	54
749-3/8	7314150363407	1	54
749-5/8	7314150363445	1	54
749-7/16	7314150363414	1	54
749-7/8	7314150363483	1	54
749-9/16	7314150363438	1	54
7490	7314150052646	10	650
7490 CO	7314150052875	10	650
74P14-200	7314150416318	1	110
74P14-300	7314150416325	1	110
74P14-400	7314150416332	1	110
74P9-100	7314150416301	1	110
74P9-20	7314150416288	1	110
74P9-60	7314150416295	1	110
74PR-100	7314150416189	1	109
74PR-100A	7314150416196	1	109
74PR-20	7314150416158	1	109
74PR-200	7314150416202	1	109
74PR-300	7314150416219	1	109
74PR-400	7314150416226	1	109
74PR-60	7314150416165	1	109
74PR-60A	7314150416172	1	109
74PS-100	7314150416257	1	110
74PS-20	7314150416233	1	110
74PS-200	7314150416264	1	110
74PS-300	7314150416271	1	110
74PS-60	7314150416240	1	110
74S/H10	7314150218622	1	164
74S/H10-2P	7314150261635	1	164
74S/H12	7314150218639	1	164



74S/H12-2P	7314150261659	1	164
74S/H14	7314150218646	1	164
74S/H14-2P	7314150261666	1	164
74S/H17	7314150218653	1	164
74S/H17-2P	7314150261673	1	164
74S/H4	7314150218578	1	164
74S/H4-2P	7314150261543	1	164
74S/H5	7314150218585	1	164
74S/H5-2P	7314150261550	1	164
74S/H6	7314150218592	1	164
74S/H6-2P	7314150261567	1	164
74S/H7	7314150218608	1	164
74S/H7-2P	7314150261574	1	164
74S/H8	7314150218615	1	164
74S/H8-2P	7314150261611	1	164
74W14-200	7314150415700	1	106
74W14-300	7314150415717	1	106
74W14-400	7314150415724	1	106
74W9-100	7314150415687	1	106
74W9-15	7314150415656	1	106
74W9-200	7314150415694	1	106
74W9-25	7314150415663	1	106
74W9-50	7314150415670	1	106
74WR-100	7314150415540	1	106
74WR-100B	7314150469871	1	106
74WR-15	7314150415519	1	106
74WR-200	7314150415557	1	106
74WR-25	7314150415526	1	106
74WR-300	7314150415564	1	106
74WR-340	7314150415571	1	106
74WR-400	7314150415588	1	106
74WR-50	7314150415533	1	106
74WS-100	7314150415625	1	106
74WS-15	7314150415595	1	106
74WS-200	7314150415632	1	106
74WS-25	7314150415601	1	106
74WS-300	7314150415649	1	106
74WS-50	7314150415618	1	106
7590	7314150052660	10	650
7590 CO	7314150052882	10	650
7591	7314150197491	1	650
75EXT	7314150415311	1	111
75P1-1500	7314150415298	1	110
75P3-1000	7314150415281	1	110
75P3-650	7314150415267	1	110
75P3-800	7314150415274	1	110
75PS-650	7314150415328	1	110
75R1-1500	7314150415236	1	107
75R3-1000	7314150415229	1	107
75R3-650	7314150415205	1	107
75R3-800	7314150415212	1	107
75S-650	7314150415243	1	108
76R1-2000	7314150522378	1	108
76R3-1000	7314150422128	1	108
76R3-1500	7314150422135	1	108
76R3-600	7314150423118	1	108
76R3-800	7314150422111	1	108
76S-600	7314150423125	1	108
7710	7314151551445	1	89
7750	7314151096427	1	88
7750-SPARE	7314150187874	1	91
7750RN	7314151831240	1	88
7750RN-SPARE	7314150209361	1	91
7750SL	7314150197675	1	88
7750SL-SPARE	7314150210268	1	90
7751	7314150386949	10	90
7752	7314151096533	1	86
7754	7314151096557	1	87
7756	7314150489152	6	87
7758-10	7314150470891	1	87
7759	7314151096601	1	87
7760	7314151096618	1	87
7760W-3	7314150470907	10	87
7760W-6	7314150470914	10	87
7761	7314151096632	1	87
7762	7314151096649	1	87
7764	7314151096670	1	88
7765	7314151096687	1	81
7766	7314151096694	1	87
7767	7314153003577	1	82
7768	7314150128433	1	87
776EX-01	7314150386130	1	87
776EX-03	7314150386154	1	87
776EX-04	7314150386161	1	87
776EX-06	7314150386178	1	87
776EX-08	7314150386185	1	87
776EX-11	7314150386147	1	87
7772H	7314150476336	10	93
7773A	7314150512270	20	88
7800DM-10	7314151096991	10	92
7800DM-11	7314151097011	10	92
7800DM-12	7314151097035	10	92
7800DM-13	7314151097059	10	92
7800DM-14	7314151097073	10	92
7800DM-15	7314151097097	10	92
7800DM-16	7314151097110	10	92

Part Number	Quantity	Part Number	Quantity
7800DM-17	10	7314151097134	10
7800DM-18	10	7314151097158	10
7800DM-19	10	7314151097172	10
7800DM-20	10	7314151097196	10
7800DM-21	10	7314151097219	10
7800DM-22	10	7314151097233	10
7800DM-23	10	7314151097257	10
7800DM-24	10	7314151097271	10
7800DM-25	10	7314151097295	10
7800DM-26	10	7314151097318	10
7800DM-27	10	7314151097332	10
7800DM-28	10	7314151097356	10
7800DM-29	10	7314151097363	10
7800DM-30	10	7314151097370	10
7800DM-31	10	7314150464548	10
7800DM-32	10	7314151097387	10
7800DM-33	10	7314150169351	10
7800DM-34	10	7314150169405	10
7800DM-36	10	7314151097400	10
7800DM-8	10	7314151830854	10
7800DM-9	10	7314151830861	10
7800DMV-10	10	7314150121656	502
7800DMV-11	10	7314150121663	502
7800DMV-12	10	7314150121670	502
7800DMV-13	10	7314150121687	502
7800DMV-14	10	7314150121694	502
7800DMV-15	10	7314150121700	502
7800DMV-16	10	7314150121717	502
7800DMV-17	10	7314150121724	502
7800DMV-18	10	7314150121731	502
7800DMV-19	10	7314150121748	502
7800DMV-20	10	7314150121755	502
7800DMV-21	10	7314150121762	502
7800DMV-22	10	7314150121779	502
7800DMV-24	5	7314150121786	502
7800DMV-27	5	7314150121793	502
7800DMV-30	5	7314150121809	502
7800DMV-32	5	7314150121816	502
7800DMV-8	10	7314150121649	502
7800DZ-1	10	7314151097561	92
7800DZ-1.1/16	10	7314151097578	92
7800DZ-1.1/2	10	7314150464562	92
7800DZ-1.1/4	10	7314151097608	92
7800DZ-1.1/8	10	7314151097585	92
7800DZ-1.3/16	10	7314151097592	92
7800DZ-1.3/8	10	7314150464586	92
7800DZ-1.5/16	10	7314150166077	92
7800DZ-1.7/16	1	7314150464609	92
7800DZ-1/2	10	7314151097455	92
7800DZ-11/16	10	7314151097493	92
7800DZ-11/32	10	7314150465712	92
7800DZ-13/16	10	7314151097523	92
7800DZ-13/32	10	7314150464623	92
7800DZ-15/16	10	7314151097554	92
7800DZ-19/32	10	7314151097479	92
7800DZ-25/32	10	7314151097516	92
7800DZ-3/4	10	7314151097509	92
7800DZ-3/8	10	7314151097431	92
7800DZ-5/16	10	7314150464647	92
7800DZ-5/8	10	7314151097486	92
7800DZ-7/16	10	7314151097448	92
7800DZ-7/8	10	7314151097530	92
7800DZ-9/16	10	7314151097462	92
7800SM-10	10	7314151097851	91
7800SM-11	10	7314151097868	91
7800SM-12	10	7314151097875	91
7800SM-13	10	7314151097882	91
7800SM-14	10	7314151097899	91
7800SM-15	10	7314151097905	91
7800SM-16	10	7314151097912	91
7800SM-17	10	7314151097929	91
7800SM-18	10	7314151097936	91
7800SM-19	10	7314151097943	91
7800SM-20	10	7314150166206	91
7800SM-21	10	7314151097967	91
7800SM-22	10	7314151097974	91
7800SM-23	10	7314151097981	91
7800SM-24	10	7314151097998	91
7800SM-25	10	7314151098001	91
7800SM-26	10	7314151830823	91
7800SM-27	10	7314151098025	91
7800SM-28	10	7314151830830	91
7800SM-29	10	7314150166213	91
7800SM-30	10	7314151098056	91
7800SM-32	10	7314151098063	91
7800SM-33	10	7314150167319	91
7800SM-34	10	7314153011305	91
7800SM-36	10	7314151098087	91
7800SM-8	10	7314151830793	91
7800SM-9	10	7314151830809	91
7800SZ-1.3/16	10	7314150528387	92
7800SZ-1/2	10	7314150528400	92
7800SZ-11/16	10	7314150528424	92
7800SZ-13/16	10	7314150528448	92
7800SZ-3/4	10	7314150528462	92
7800SZ-3/8	10	7314150528486	92

Part Number	Quantity	Part Number	Quantity
7800SZ-7/16	10	7314150528509	10
7800SZ-7/8	10	7314150528523	10
7800SZ-9/16	10	7314150528547	10
7800TORX-E10	1	7314150166084	93
7800TORX-E11	1	7314150220359	93
7800TORX-E12	1	7314153011800	93
7800TORX-E14	1	7314153011756	93
7800TORX-E16	1	7314153011763	93
7800TORX-E18	1	7314153011770	93
7800TORX-E20	1	7314153011787	93
7800TORX-E24	1	7314153011794	93
7800TORX-E8	1	7314150166091	93
7800TORX/9	1	7314150469741	96
7805DM-10	10	7314151822101	92
7805DM-12	10	7314151098452	10
7805DM-13	10	7314151098469	10
7805DM-14	10	7314151098476	10
7805DM-15	10	7314151098483	10
7805DM-16	10	7314151098490	10
7805DM-17	10	7314151098506	10
7805DM-18	10	7314151098513	10
7805DM-19	10	7314151098520	10
7805DM-21	10	7314151098544	10
7805DM-22	10	7314151098551	10
7805DM-23	10	7314150313532	10
7805DM-24	10	7314151098568	10
7805DM-26	10	7314151098582	10
7805DM-27	10	7314151098599	10
7805DM-30	10	7314151098605	10
7805DM-32	10	7314150220281	10
7805DM-34	10	7314150488537	10
7805DZ-1	10	7314150357758	93
7805DZ-1.1/16	10	7314150357765	10
7805DZ-1.1/2	10	7314150357833	10
7805DZ-1.1/4	10	7314150357796	10
7805DZ-1.1/8	10	7314150357772	10
7805DZ-1.3/16	10	7314150357789	10
7805DZ-1.3/8	10	7314150357819	10
7805DZ-1.5/16	10	7314150357802	10
7805DZ-1.7/16	10	7314150357826	10
7805DZ-11/16	10	7314150357703	10
7805DZ-13/16	10	7314150357727	10
7805DZ-15/16	10	7314150357741	10
7805DZ-3/4	10	7314150357710	93
7805DZ-5/8	10	7314150357697	10
7805DZ-7/8	10	7314150357734	10
7805GPR-16	120	7314150503117	307
7805GPR-21	100	7314150503124	307
7805SM-10	10	7314153011312	91
7805SM-11	10	7314150475926	91
7805SM-12	10	7314153011329	91
7805SM-13	10	7314153011336	10
7805SM-14	10	7314153011343	10
7805SM-15	10	7314153011350	10
7805SM-16	10	7314153011367	91
7805SM-17	10	7314153011374	91
7805SM-18	10	7314153011381	10
7805SM-19	10	7314153011398	91
7805SM-20	10	7314153011404	10
7805SM-21	10	7314153011411	10
7805SM-22	10	7314153011428	10
7805SM-23	10	7314153011435	10
7805SM-24	10	7314153011442	10
7805SM-25	10	7314153011459	91
7805SM-26	10	7314153011466	10
7805SM-27	10	7314153011473	91
7805SM-28	10	7314153011480	91
7805SM-29	10	7314153011497	10
7805SM-30	10	7314153011503	10
7805SM-32	10	7314153011527	10
7805SM-34	10	7314153024251	91
7805SZ-1.1/2	1	7314150357987	91
7805SZ-1.1/4	1	7314150357949	91
7805SZ-1.3/16	1	7314150357932	91
7805SZ-1.3/8	1	7314150357963	91
7805SZ-1.5/16	1	7314150357956	91
7805SZ-1.7/16	1	7314150357970	91
7806MD	1	7314150220335	76
7807H	1	7314151232764	177
7807TE	1	7314150313792	76
7808H	1	7314151232771	177
7808HM	1	7314150220434	96
7809F-10	5	7314151830892	95
7809F-8	5	7314151830885	95
7809H	1	7314151232788	177
7809HL	1	7314150128464	95
7809M-10	1	7314151815608	96
7809M-10-120	1	7314150509669	96
7809M-12	1	7314151815615	96
7809M-12-120	1	7314150509683	96
7809M-14	1	7314151815622	96
7809M-14-120	10	7314150509706	96
7809M-17	1	7314151831028	96
7809M-17-120	1	7314150509720	96
7809M-19	1	7314151831035	96
7809M-19-120	8	7314150516575	96



7809M-4



7809M-4	7314150214600	10	96
7809M-4-120	7314150509591	1	96
7809M-5	7314151815561	1	96
7809M-5-120	7314150509607	1	96
7809M-5-180	7314151830922	1	96
7809M-6	7314151815578	1	96
7809M-6-120	7314150509621	1	96
7809M-7	7314151815585	1	96
7809M-7-100	7314151830960	1	96
7809M-8	7314151815592	1	96
7809M-8-120	7314151830984	1	96
7809M-9	7314151830991	1	96
7809M/10	7314151831448	1	73
7809PH-2	7314151830908	1	95
7809PH-3	7314151830915	1	95
7809PH-4	7314153003423	1	95
7809PZ-2	7314153003430	1	95
7809PZ-3	7314153003447	1	95
7809TO	7314150220465	1	96
7809TORX-T20	7314151811730	1	95
7809TORX-T20-120	7314150509768	1	96
7809TORX-T25	7314151811747	1	95
7809TORX-T25-120	7314150509799	1	96
7809TORX-T27	7314151811754	1	95
7809TORX-T27-120	7314150509812	1	96
7809TORX-T30	7314151811761	1	95
7809TORX-T30-120	7314150509836	1	96
7809TORX-T40	7314151811778	1	95
7809TORX-T40-120	7314150220564	1	96
7809TORX-T45	7314151811785	1	95
7809TORX-T45-120	7314150220557	1	96
7809TORX-T50	7314151811792	1	95
7809TORX-T50-100	7314150220540	1	96
7809TORX-T55	7314151811808	1	95
7809TORX-T55-120	7314150509874	1	96
7809TORX-T60	7314151811815	1	95
7809TORX-T60-120	7314150509898	1	96
7809TORX-T70	7314150509744	10	95
7809TORX-T70-140	7314150220526	5	96
7809TORX/10	7314151831455	1	73
7809XZN-10	7314151831080	1	97
7809XZN-10-100	7314151831097	1	97
7809XZN-12	7314151831103	1	97
7809XZN-12-100	7314151831110	1	97
7809XZN-14	7314153004574	1	97
7809XZN-14-100	7314153004567	1	97
7809XZN-16	7314150220458	1	97
7809XZN-18	7314150314058	1	97
7809XZN-6	7314150214617	1	97
7809XZN-8	7314151831066	1	97
7809XZN-8-100	7314151831073	1	97
7809Z-1/2	7314153003515	1	96
7809Z-1/4	7314153003478	1	96
7809Z-17/32	7314150313785	1	96
7809Z-19/32	7314153003546	1	96
7809Z-3/16	7314153003461	1	96
7809Z-3/8	7314153003492	1	96
7809Z-5/16	7314153003485	1	96
7809Z-5/8	7314153003553	1	96
7809Z-7/16	7314153003508	1	96
7809Z-9/16	7314153003539	1	96
7809Z/10	7314153003560	1	73
7810MB	7314150220380	1	76
7810MH	7314150220373	1	76
7811DMV	7314150122134	1	504
7812	7314150502028	100	318
7814DS	7314150318964	1	73
7817DZS	7314150319008	1	74
7817DZS1	7314150389902	1	75
7818DS	7314150318971	1	73
7818DST	7314150319039	1	75
7818MHR	7314150218912	1	73
7818SST	7314150319046	1	75
7819DRN	7314151831547	1	74
782-U	7311518276447	1	308
7823	7314150218141	1	170
7823DZS	7314150319015	1	75
7825DST	7314150319060	1	75
7825MBP	7314150218929	1	74
7825MHP	7314150218943	1	74
7825SST	7314150319053	1	75
7827DST	7314150319077	1	76
783	7311518276034	1	326
7835 G-160	7314150050253	5	245
7847SS	7314150318995	1	74
7851-G	7314150124909	1	115
7851-M	7314150124893	1	115
7865	7311518276720	1	170
787-1.1/16	7314150363186	1	51
787-1.1/2	7314150363254	1	51
787-1.1/4	7314150363216	1	51
787-1.1/8	7314150363193	1	51
787-1.11/16	7314150363278	1	51
787-1.13/16	7314150363292	1	51
787-1.3/16	7314150363209	1	51
787-1.3/4	7314150363285	1	51



787-1.3/8	7314150363230	1	51
787-1.5/16	7314150363223	1	51
787-1.5/8	7314150363261	1	51
787-1.7/16	7314150363247	1	51
787-1.7/8	7314150363308	1	51
787-2	7314150363315	1	51
787-2.1/4	7314150363346	1	51
787-2.1/8	7314150363322	1	51
787-2.3/16	7314150363339	1	51
787-2.3/8	7314150363353	1	51
7888DM	7314151820923	1	74
789-1.1/2	7314150363896	1	55
789-1.1/4	7314150363858	1	55
789-1.1/8	7314150363841	1	55
789-1.13/16	7314150363933	1	55
789-1.3/4	7314150363926	1	55
789-1.3/8	7314150363872	1	55
789-1.5/16	7314150363865	1	55
789-1.5/8	7314150363919	1	55
789-1.7/16	7314150363889	1	55
789-1.9/16	7314150363902	1	55
789-2	7314150363940	1	55
789-2.1/4	7314150363957	1	55
789-2.3/8	7314150363971	1	55
789-2.5/16	7314150363964	1	55
789-28	7314150363742	1	55
789-30	7314150363759	1	55
789-32	7314150363767	1	55
789-34	7314150363766	1	55
789-36	7314150363773	1	55
789-38	7314150363780	1	55
789-40	7314150363797	1	55
789-41	7314150363803	1	55
789-42	7314150363810	1	55
789-46	7314150363827	1	55
789-50	7314150363834	1	55
7890	7314150052691	10	651
7890 CO	7314150052899	10	651
7891	7314150052714	10	651
7891 CO	7314150052905	10	651
7892	7314150052738	10	651
7892 CO	7314150291687	10	651
7893	7314150052769	10	652
7893K	7314150351428	10	652
7894	7314150197484	10	652
790450A	7314150214716	1	264
790455A	7314150214709	1	264
7992	7314150470921	5	654
7993M0170	8413345115353	1	182
7993M0190	8413345115377	1	182
7993M0220	8413345115391	1	182
7993M0270	8413345115414	1	182
7993S0050	8413345115070	1	177
7993S0060	8413345115094	1	177
7993S0080	8413345115117	1	177
7993S0100	8413345115131	1	177
7993S0120	8413345115155	1	177
7993S0140	8413345115179	1	177
7993S0170	8413345115193	1	177
7993S0180	7314150476855	1	177
7993S0190	8413345115216	1	177
7993T0120	8413345115230	1	180
7993T0140	8413345115254	1	180
7993T0170	8413345115278	1	180
7993T0190	8413345115292	1	180
7993T0220	8413345115315	1	180
7993T0240	8413345115339	1	180
7994S0200	7314150492954	1	177
7994S0250	7314150492947	1	177
7994S0270	7314150492930	1	177
7994S0300	8413345129305	1	177
7994S0400	8413345129312	1	177
7994S0450	8413345129329	1	177
7994S0500	8413345129336	1	177
7994S0550	8413345129343	1	177
7994S0600	8413345129350	1	177
7994S0700	7314150522583	1	177
800-1.5-50ESD	8412243589327	10	653
800-2.50ESD	8412243589341	10	653
800-2.5-50ESD	8412243589365	10	653
800-3-50ESD	8412243589389	10	653
801-0-50ESD	8412243589426	10	653
801-00-50ESD	8412243589402	10	653
801-1-75ESD	8412243589440	10	653
801-7ESD	8412243589280	1	653
8010SL-2P	7314150243853	1	498
801C	7314150402151	10	652
8020-2P	7314150246601	1	195
803-10-50ESD	8412243589648	10	653
803-15-75ESD	8412243589549	10	653
803-20-75ESD	8412243589563	10	653
803-6-50ESD	8412243589464	10	653
803-7-50ESD	8412243589488	10	653
803-7ESD	8412243589303	1	653
803-8-50ESD	8412243589501	10	653
803-9-50ESD	8412243589525	10	653



8030-2P	7314150246618	1	195
8040-2P	7314150246625	1	195
8040L-2P	7314150246670	1	196
8040SL-2P	7314150243877	1	498
8045LVDE	7314151509163	10	219
8045VDE	73141515137256	10	219
805-TS1-50ESD	8412243589587	10	653
805-TS4-50ESD	8412243589600	10	653
805-TS5-50ESD	8412243589624	10	653
8050SL-2P	7314150243884	1	498
8052	7314151318406	5	218
806-1-1	7311518003760	6	219
806-1-2	7314150183258	6	219
806-1-3	7314150183265	6	219
8060B0080	8413345018104	1	267
8060B0100	8413345018111	1	267
8060B0120	8413345018128	1	267
8060B0140	8413345018135	1	267
8060B0180	8413345018142	1	267
8060B0240	8413345018159	1	267
8060B0360	8413345018166	1	267
8060T0080	8413345018173	1	267
8060T0100	8413345018180	1	267
8060T0140	8413345018203	1	267
8060T0180	8413345018210	1	267
8060T0240	8413345018227	1	267
8060T0360	8413345018234	1	267
8069	7314150007028	5	39
8069 C	7314150007035	5	39
8069 C IP	7314150101634	5	39
8069 IP	7314150007042	50	39
8069-1	7314150239511	1	39
8069-2	7314150238590	1	39
8070	7314150007110	5	39
8070 C	7314150007127	5	39
8070 C IP	7314150101641	5	39
8070 IP	7314150007134	40	39
8070-1	7314150239528	1	39
8070-2	7314150238606	1	39
8070V	7314150121519	2	501
8070VL	7314150213511	1	501
8071	7314150007202	5	39
8071 C	7314150007219	5	39
8071 C IP	7314150101658	5	39
8071 IP	7314150007226	50	39
8071-1	7314150239535	1	39
8071-2	7314150238613	1	39
8071V	7314150121526	2	501
8071VL	7314150213535	1	501
8071VLT	7314150121564	1	501
8072	7314150007288	5	39
8072 C	7314150007295	5	39
8072 C IP	7314150101665	5	39
8072 IP	7314150007301	30	39
8072-1	7314150239542	1	39
8072-2	7314150238620	1	39
8072V	7314150121533	2	501
8072VL	7314150213542	1	501
8072VLT	7314150121571	1	501
8073	7314150007363	5	39
8073 C	7314150007370	5	39
8073 C IP	7314150101672	5	39
8073 IP	7314150007387	20	39
8073-1	7314150239559	1	39
8073-2	7314150238637	1	39
8073V	7314150121540	2	501
8073VL	7314150213559	1	501
8073VLT	7314150121588	1	501
8074	7314150007448	3	39
8074 C	7314150007455	3	39
8074 C IP	7314150101689	3	39
8074 IP	7314150007462	20	39
8074-1	7314150239566	1	39
8074-2	7314150238644	1	39
8074V	7314150121557	2	501
8075	7314150007523	3	39
8075 C	7314150007530	3	39
8075 C IP	7314150101696	3	39
8075 IP	7314150007547	10	39
8075-1	7314150239573	1	39
8075-2	7314150238651	1	39
808050	7314153017642	50	211
808050A	7314150127306	1	217
808050L	7314150128075	25	211
808050L-SP1	7314150129218	1	211
808050P	7314150128105	50	211
808050P-25	7314150165179	10	211
808050S	7314150128082	25	212
808050S-18	7314150128921	30	212
808050S-22	7314150128938	30	212
808050TORX	7314150127313	50	217
808050TS	7314150128099	1	211
808060	7314150243822	1	498
808061	7314150243839	5	498
808062	7314150243846	5	498
8100B0140	7314150263028	1	267



8100B0180	7314150263042	1	267
8100B0240	8413345018296	1	267
8100B0360	84133450099660	1	267
8100F0180	7314150263059	1	267
8100F0240	7314150263066	1	267
8100T0100	7314150263073	1	267
8100T0140	8413345018333	1	267
8100T0180	7314150263080	1	267
8100T0240	7314150263097	1	267
8100T0360	7314150263103	1	267
8100T0480	7314150263127	1	267
8110H-1/2	7314153015860	1	97
8120-1/2	7314150384884	12	97
8120-1/4	7314150384921	20	84
8120-3/8	7314150384914	10	89
813	7314150055852	1	649
8130	7314150050918	10	644
8130-50/SUPR SPRING	7314150111572	1	649
8131	7314150050925	10	644
8131 CO	7314150051519	10	644
8132	7314150050932	10	644
8133	7314150470945	10	644
8134	7314150470952	10	644
8135	7314150470969	10	644
8136	7314150470976	10	645
8137	7314150459728	10	645
8138	7314150361540	10	645
814	7314150055845	1	649
8140	7314150050949	10	644
8140 CO	7314150051533	10	644
8140M2	7314150470983	10	649
8140PS	7314150358472	10	649
8141	7314150050987	10	644
8141 CO	7314150051557	10	644
8141PS	7314150349425	10	649
8142	7314150051007	10	644
8142 CO	7314150051564	10	644
8143	7314150051021	10	644
8144	7314150051045	10	644
8144 CO	7314150051601	10	644
8145	7314150051052	10	644
8146	7314150051076	10	645
8147	7314150051083	10	645
8148	7314150051090	10	645
8148 CO	7314150051656	10	645
8149	7314150051106	10	648
8150	7314150051113	10	644
8150 CO	7314150051670	10	644
8150 J	7314150051137	10	654
8150 SK	7314150112814	10	654
8150-1/2	7314151105006	1	97
8150-1/2-SPARE	7314150187881	1	98
8150-1/2V	7314150121601	1	502
8150M2	7314150470990	10	649
8150PS	7314150358489	10	649
8150RN-1/2	7314151831202	1	97
8150RN-1/2-SPARE	7314150209378	1	98
8150SL	7314150197682	1	97
8150SL-SPARE	7314150210275	1	98
8151	7314150051199	10	644
8151 CO	7314150051694	10	644
8151-1/2	7314151105112	1	98
8152	7314150052097	10	644
8152-1/2	7314151105129	1	93
8153	7314150051205	10	644
8154	7314150052103	10	644
8154 CO	7314150052233	10	644
8154-1/2V	7314150121595	1	502
8154-11	7314150469161	10	93
8154PSP	7314150347704	10	650
8155	7314150052110	10	644
8156	7314150051212	10	645
8157	7314150052127	10	645
8157-10	7314150467273	1	93
8157-15	7314150469222	1	93
8157-24	7314150469246	1	93
8157-36	7314150469260	10	93
8158	7314150052134	10	645
8158-10	7314150471003	1	93
8158-15	7314150471010	1	93
816	7314150428182	1	649
8160	7314150051229	10	644
8160 CO	7314150051724	10	644
8160 J	7314150051250	10	654
8160 M2	7314150381906	10	649
8160-1/2V	7314150121618	1	502
8160-10	7314150469185	10	93
8160-3	7314150469208	10	93
8160-5	7314150469284	10	93
8160-B	7314150182565	1	94
8160/SPRING	7314150229888	1	649
8160PS	7314150358496	10	649
8160W-10	7314150471027	10	94
8160W-3	7314150471041	10	94
8160W-5	7314150471065	10	94
8161	7314150051328	10	644





8161 CO	7314150051748	10	644
8161PS	7314150361533	10	649
8162	7314150051335	10	644
8162-1/2V	7314150121625	1	502
8163	7314150051342	10	644
8163 CO	7314150051762	10	644
8164	7314150052141	10	644
8164-1/2	7314151105266	1	88
8165	7314150052158	10	644
8165 CO	7314150052288	10	644
8166	7314150459377	10	94
8166L	7314150476350	10	645
8167	7314153003584	1	88
8167L	7314150476367	10	645
8168	7314150128440	1	94
8168L	7314150347711	10	645
8171	7314150469307	10	94
8172	7314150469321	10	94
8174A	7314150476374	10	94
8178	7314150512065	10	93
8194-1/2	7314151831226	1	98
8195-KEY	7314150389810	50	94
8195-R	7314150389780	1	97
8195-SET	7314150389797	5	97
8195-SQ	7314150389803	25	98
8211	7314150101030	10	646
8220SL-2P	7314150243860	1	498
8223	7314150112685	4	247
8223 IP	7314150113149	4	247
8224	7314150000012	4	247
8224 IP	7314150101757	4	247
8224CIP	7314150103607	4	247
8225	7314150000029	4	247
8225 IP	7314150101764	4	247
8225CIP	7314150103614	4	247
8226	7314150115853	1	247
8231	7311518266509	4	247
8231 IP	7311518270285	4	247
8242-2P	7314150243686	1	195
8242L-2P	7314150246687	1	196
8247	7314150051397	10	646
8247 CO	7314150051809	10	646
8248	7314150051427	10	647
8248 CO	7314150051823	10	647
8248Q	7314150349364	10	648
8249	7314150349401	10	647
8252-2P	7314150243693	1	195
8252L-2P	7314150246694	1	196
8252XL-1P	7314150265985	1	197
833AJ-4	7311518286927	1	590
833AJ-5	7311518286934	1	590
833AJ-6	7311518286941	1	590
833FJ-4	7311518286965	1	590
833FJ-5	7311518286972	1	590
833FJ-6	7311518286989	1	590
833PJ-4	7311518286897	1	589
833PJ-5	7311518286903	1	589
833PJ-67	7311518286910	1	589
833SB-4	7311518286859	1	590
833SB-5	7311518286866	1	590
833SB-6	7311518286873	1	590
833SB-7	7311518286880	1	590
834V-2	7314150124992	1	589
834V-4	7311518286811	1	589
834V-5	7311518286828	1	589
834V-6	7311518286835	1	589
834V-7	7311518286842	1	589
84-PODGER	7314150307494	1	40
850-1	7311518292737	10	548
8501-10	7311518004828	1	141
8501-10F	7311518220945	1	141
8501-12	7311518004842	1	141
8501-12F	7311518220952	1	141
8501-13	7311518004859	1	141
8501-136-10-24C	7314150371471	1	141
8501-136-20-24C	7314150371488	1	141
8501-13F	7311518220969	1	141
8501-15	7311518004873	1	141
8501-150-10-24C	7314150403004	1	141
8501-15F	7311518220976	1	141
8501-16	7311518004880	1	141
8501-160-20-24C	7314150403011	1	141
8501-160-20-48XF	7314150402892	1	141
8501-165-20-24C	7314150403028	1	141
8501-165-20-48XF	7314150402908	1	141
8501-16F	7311518220983	1	141
8501-16SW	7314150258642	1	141
8501-17	7311518004897	1	141
8501-17F	7311518220990	1	141
8501-17S	7311518221027	1	142
8501-184-16-24	7314150402946	1	141
8501-184-16-40	7314150402953	1	141
8501-184-20-24C	7314150403042	1	141
8501-18S	7311518221034	1	142
8501-18SW	7311518221058	1	141
8501-190-30-24C	7314150403059	1	141



8501-190-30-60XF	7314150402960	1	141
8501-2	7311518004743	1	141
8501-210-30-48SW	7314150403066	1	141
8501-210-30-60XF	7314150402977	1	141
8501-216-60SW	7314150359448	1	141
8501-22	7311518178888	1	141
8501-22F	7311518221003	1	141
8501-23	7311518004958	1	141
8501-230-30-60XF	7314150402984	1	141
8501-235-30-60XF	7314150402991	1	141
8501-23F	7311518018887	1	141
8501-260-24SW	7314150359479	1	141
8501-260-30-80S	7314150403097	1	142
8501-260-40SW	7314150359462	1	141
8501-260-60SW	7314150359455	1	141
8501-28	7311518018894	1	141
8501-28F	7311518221010	1	141
8501-28S	7311518221041	1	142
8501-28SW	7311518221065	1	141
8501-28XF	7311518281946	1	141
8501-3	7311518004750	1	141
8501-30	7311518237479	1	141
8501-305-30-40SW	7314150403073	1	141
8501-305-30-60SW	7314150403080	1	141
8501-305-30-96S	7314150403103	1	142
8501-30F	7311518237462	1	141
8501-30S	7311518282240	1	142
8501-30SW	7311518282196	1	141
8501-30XF	7311518281984	1	141
8501-31	7311518237455	1	141
8501-31F	7311518237448	1	141
8501-4	7311518008079	1	141
8501-40	7311518282042	1	141
8501-4F	7311518220914	1	141
8501-4XF	7311518281786	1	141
8501-5	7311518004774	1	141
8501-5F	7311518220921	1	141
8501-7	7311518004798	1	141
8501-7F	7311518220938	1	141
8510SL-2P	7314150245758	1	498
8520SL-2P	7314150245765	1	498
86	7314150005376	1	39
86-1	7314150254996	1	39
86-2	7314150255009	1	39
8600-2P	7314150246564	1	195
8610-2P	7314150243648	1	195
8610L-2P	7314150246700	1	196
8610SL-2P	7314150243891	1	498
8620-2P	7314150243662	1	195
8620L-2P	7314150246717	1	196
8620SL-2P	7314150243907	1	498
8620XL-1P	7314150265947	1	197
8630-2P	7314150246571	1	195
8630XL-1P	7314150265961	1	197
864000010	8413345137638	1	553
864000020	7314150330171	1	553
864002450	8413345129022	50	553
864100010	8413345137621	1	553
864102400	8413345129015	1	553
865-1	7311518292744	10	548
869102500	8413345083669	6	578
869103000	8413345116640	6	578
869203000	8413345137508	6	578
87	7314150005406	3	39
87-1	7314150255016	1	39
87-2	7314150255023	1	39
8703-2P	7314150246632	1	196
8704-2P	7314150246649	1	196
8705-2P	7314150246656	1	196
8706-2P	7314150246663	1	196
8710SL-2P	7314150245772	1	498
8720SL-2P	7314150245789	1	498
874002000	8413345024938	5	605
874002500	8413345024945	5	605
874003000	8413345024952	5	605
874003500	8413345024969	5	605
874004000	8413345024976	5	605
874005000	8413345024983	5	605
874102000	8413345080989	6	605
874102500	8413345081009	5	605
874103000	8413345081023	5	605
874103500	8413345081047	4	605
874104000	8413345081061	5	605
874602000	8413345024990	5	605
874602500	8413345025003	5	605
874603000	8413345025065	5	605
874603500	8413345025072	5	605
874604000	8413345025089	5	605
874916X16	7314150489787	1	606
874918X18	7314150489800	1	606
874923X13	7314150489763	1	606
874926X7	7314150489749	1	606
876002000	8413345025119	10	606
876002500	8413345025126	5	606
877002400	8413345025140	25	606
8800-2P	7314150246588	1	195



8810-2P	7314150243655	1	195
8810L-2P	7314150246724	1	196
8810SL-2P	7314150243914	1	498
8820-2P	7314150243679	1	195
8820L-2P	7314150246731	1	196
8820SL-2P	7314150243921	1	498
8820XL-1P	7314150265954	1	197
8821MB	7314150220571	1	77
8830-2P	7314150246595	1	195
8830XL-1P	7314150265978	1	197
8840M	7314151105495	1	77
8845DM	7314151105525	1	77
8845NM	7314151810955	1	77
8900DM-19	7314151105730	1	99
8900DM-21	7314150166367	5	99
8900DM-22	7314151105754	1	99
8900DM-23	7314150166374	1	99
8900DM-24	7314151105778	1	99
8900DM-25	7314151105785	1	99
8900DM-26	7314150219797	1	99
8900DM-27	7314151105822	1	99
8900DM-28	7314151105846	1	99
8900DM-29	7314150219803	1	99
8900DM-30	7314151105884	5	99
8900DM-32	7314151105891	1	99
8900DM-33	7314150166398	1	99
8900DM-34	7314151838478	1	99
8900DM-35	7314150219810	1	99
8900DM-36	7314151105914	1	99
8900DM-37	7314150166404	1	99
8900DM-38	7314150219827	1	99
8900DM-40	7314150166411	1	99
8900DM-41	7314151105938	5	99
8900DM-42	7314150166428	1	99
8900DM-46	7314151105952	1	99
8900DM-47	7314150166435	1	99
8900DM-50	7314151105969	5	99
8900DM-52	7314150166442	1	99
8900DM-54	7314150166459	3	99
8900DM-55	7314151105983	1	99
8900DM-56	7314150166466	1	99
8900DM-60	7314151106003	5	99
8900DZ-1	7314151106058	1	99
8900DZ-1.1/16	7314151106065	1	99
8900DZ-1.1/2	7314151106133	1	99
8900DZ-1.1/4	7314151106096	1	99
8900DZ-1.1/8	7314151106072	1	99
8900DZ-1.11/16	7314150166282	1	99
8900DZ-1.13/16	7314151106188	1	99
8900DZ-1.3/4	7314151106171	1	99
8900DZ-1.3/8	7314151106119	1	99
8900DZ-1.5/16	7314151106102	5	99
8900DZ-1.5/8	7314151106157	1	99
8900DZ-1.7/8	7314151106195	1	99
8900DZ-1.9/16	7314150166299	1	99
8900DZ-13/16	7314150166305	1	99
8900DZ-15/16	7314151106034	1	99
8900DZ-2	7314151106201	1	99
8900DZ-2.1/16	7314150166312	1	99
8900DZ-2.1/4	7314150166329	1	99
8900DZ-2.1/8	7314150166336	1	99
8900DZ-2.3/16	7314150358670	1	99
8900DZ-2.3/8	7314150166350	1	99
8900DZ-3/4	7314150166381	1	99
8900DZ-31/32	7314150358663	1	99
8900DZ-7/8	7314150166473	1	99
8900SM-19	7314150166633	1	98
8900SM-22	7314151810795	1	98
8900SM-23	7314150219834	1	98
8900SM-24	7314151810801	5	98
8900SM-26	7314150219841	1	98
8900SM-27	7314151810818	5	98
8900SM-28	7314150166657	1	98
8900SM-29	7314150219858	1	98
8900SM-30	7314151810825	5	98
8900SM-32	7314151810832	5	98
8900SM-33	7314150166671	1	98
8900SM-34	7314151838461	1	98
8900SM-35	7314150166688	1	98
8900SM-36	7314151810849	5	98
8900SM-38	7314151810856	1	98
8900SM-41	7314151810863	5	98
8900SM-42	7314150219865	1	98
8900SM-46	7314151810870	1	98
8900SM-50	7314151810887	1	98
8900SM-55	7314151810894	1	98
8900SM-60	7314151810900	1	98
8900SZ-1	7314150166648	1	98
8900SZ-1.7/16	7314150166589	1	98
8900SZ-1.7/8	7314150166596	1	98
8900SZ-1.9/16	7314150166602	1	98
8900SZ-13/16	7314150166619	1	98
8900SZ-2	7314150166640	1	98
8900SZ-3/4	7314150166664	1	98
89049TM-1000	7314150415403	1	113
8905-TM	7314150125470	1	114

8910-2P	7314150243709	1	196
8910SL-2P	7314150243938	1	498
8915-2P	7314150243716	1	196
8915L-2P	7314150258765	1	196
8915SL-2P	7314150243945	1	498
8920-2P	7314150243723	1	196
8920L-2P	7314150258772	1	196
8920SL-2P	7314150243952	1	498
89222CR-1000	7314150415441	1	114
8925-2P	7314150243730	1	196
8925L-2P	7314150258789	1	196
8925SL-2P	7314150243969	1	498
8927-2P	7314150243747	1	196
8927L-2P	7314150263516	1	196
8930-2P	7314150243754	1	196
8930L-2P	7314150258796	1	196
8930SL-2P	7314150243976	1	498
8940-2P	7314150243761	1	196
894M-10	7314151833039	10	51
894M-100	7314151833305	1	51
894M-105	7314151833312	1	51
894M-11	7314151833046	1	51
894M-110	7314151833329	1	51
894M-115	7314151833336	1	51
894M-12	7314151833053	10	51
894M-120	7314151833343	1	51
894M-125	7314150132478	1	51
894M-13	7314151833060	10	51
894M-130	7314150132485	1	51
894M-135	7314150132492	1	51
894M-14	7314151833077	10	51
894M-15	7314151833084	10	51
894M-16	7314150139569	10	51
894M-17	7314151833091	10	51
894M-19	7314151833107	10	51
894M-21	7314150223220	5	51
894M-22	7314151833114	5	51
894M-24	7314151833121	5	51
894M-27	7314151833138	5	51
894M-30	7314151833145	5	51
894M-32	7314151833152	5	51
894M-34	7314150139583	1	51
894M-36	7314151833169	5	51
894M-38	7314151833176	1	51
894M-41	7314151833183	1	51
894M-46	7314151833190	1	51
894M-50	7314151833206	1	51
894M-55	7314151833213	1	51
894M-60	7314151833220	1	51
894M-65	7314151833237	1	51
894M-7	7314151833008	10	51
894M-70	7314151833244	1	51
894M-75	7314151833251	1	51
894M-8	7314151833015	10	51
894M-80	7314151833268	1	51
894M-85	7314151833275	1	51
894M-9	7314151833022	10	51
894M-90	7314151833282	1	51
894M-95	7314151833299	1	51
8950NA-SO/2	7314151816605	1	101
8950RN	7314150522675	1	100
8950RN/A	7314150521258	1	100
8951	7314151106782	1	101
8951-M	7314150124916	1	115
8952N/B	7314150180219	1	99
8953E-32	7314150509447	1	99
8954-15	7314150522774	1	99
8954A	7314151106812	1	99
8955N	7314150434114	1	100
8955N-SPARE	7314150434121	1	101
8955N/A	7314150434053	1	100
8955N/B	7314150434176	5	100
8957-19	7314150522781	1	99
8957A	7314150510580	1	99
8958A	7314151106836	1	99
895M-10-11	7314151832742	10	49
895M-10-13	7314151832759	10	49
895M-13-17	7314151832803	10	49
895M-17-19	7314151832827	10	49
895M-19-22	7314151832834	10	49
895M-19-24	7314151832841	5	49
895M-22-24	7314151832858	5	49
895M-24-27	7314151832865	5	49
895M-24-30	7314151832872	5	49
895M-27-32	7314151832889	5	49
895M-30-32	7314151832896	5	49
895M-30-36	7314151832902	1	49
895M-32-36	7314151832919	1	49
895M-36-41	7314151832926	1	49
895M-41-46	7314151832933	1	49
895M-46-50	7314151832940	1	49
895M-50-55	7314151832957	1	49
895M-55-60	7314151832964	1	49
895M-6-7	7314151832711	1	49
895M-65-70	7314151832971	10	49
895M-8-10	7314151832735	10	49





895M-8-9	7314151832728	10	49
8960-16	7314150492855	12	100
8960-8	7314150492862	1	100
8963	7314150181087	1	99
8966	7314151106898	1	100
8967	7314153003591	1	94
8967/S3	7314153003607	1	82
8971	7314150492879	1	100
8972	7314150492886	1	100
9-12-51/3806-KP	7311518044558	5	634
9-462-14-0-0	7311518020873	5	35
9-467-00-0-0	7311518020897	1	35
9-469-00-0-0	7311518020903	1	35
9-484-3.2-10	7311518193348	10	35
9-484-3.2-1P	7311518193522	10	35
9-484-5.2-10	7311518193355	10	35
9-484-5.2-1P	7311518193331	10	35
9-485-04-10	7314150271672	10	36
9-485-04-1P	7314150271665	10	36
9-485-05-10	7314150271696	10	36
9-485-05-1P	7314150271689	10	36
9-485-06-10	7311518193508	10	36
9-485-06-1P	7311518193492	20	36
9-485-09-10	7311518193386	10	36
9-485-09-1P	7311518193362	20	36
9-485-13-10	7311518193393	10	36
9-485-13-1P	7311518193379	1	36
9-486-04-10	7311518193430	10	36
9-486-04-1P	7311518193409	20	36
9-486-05-10	7311518193461	10	36
9-486-05-1P	7311518193447	20	36
9-486-07-10	7311518249373	10	36
9-486-07-1P	7311518249359	20	36
9-486-08-10	7311518270933	10	36
9-486-C-10	7311518209599	10	36
9-486-C-1P	7311518209605	10	36
9-488-02-10	7311518194772	10	35
900T-020-100	7314153018106	5	216
900T-025-100	7314153018113	5	216
900T-030-100	7314153018120	5	216
900T-040-150	7314153018137	5	216
900T-050-150	7314153018144	5	216
900T-060-200	7314153018151	5	216
900T-080-200	7314153018168	5	216
900T-100-200	7314153018175	5	216
901T-006-100	7314153018182	5	216
901T-007-100	7314153018199	5	216
901T-008-100	7314153018205	5	216
901T-009-100	7314153018212	5	216
901T-010-100	7314153018229	5	216
901T-015-150	7314153018236	5	216
901T-020-150	7314153018243	5	216
901T-025-150	7314153018250	5	216
901T-027-150	7314153018267	5	216
901T-030-200	7314153018274	5	216
901T-040-200	7314153018281	5	216
901T-045-200	7314153018298	5	216
901T-050-200	7314153018304	5	216
9029	7314153010612	5	38
9029 C	7314153010629	5	38
9029-1	7314150239580	1	39
9029-2	7314150238668	1	39
9029-T	7314150189076	5	38
9029T-1	7314150312139	1	39
902T-050-150	7314153018311	5	216
902T-055-150	7314153018328	5	216
902T-060-150	7314153018335	5	216
902T-070-175	7314153018342	5	216
902T-080-175	7314153018359	5	216
902T-090-175	7314153018366	5	216
902T-100-175	7314153018373	5	216
902T-110-175	7314153018380	5	216
902T-120-175	7314153018397	5	216
902T-130-175	7314153018403	5	216
9031	7314150110988	5	38
9031 C	7314150113507	5	38
9031 P-1	7314150266302	1	39
9031-1	7314150239597	1	39
9031-8224	7314150321193	3	258
9031-T	7314150131648	5	38
9031P	7314150187539	5	38
9031T-1	7314150312146	1	39
9033	7314150181414	5	38
9033-1	7314150353804	1	39
9035	7314150181421	5	38
9035-1	7314150353811	1	39
903T-1	7314153018410	1	215
903T-2	7314153018427	1	215
903T-3	7314153018434	1	215
9045-B-200	7311518012175	6	544
9045-B-250	7311518012182	6	544
9045-B-300	7311518012199	6	544
9045-B-400	7311518178123	1	544
9048-200	7314150138159	10	544
9048-250	7314150138166	10	544
9048-300	7314150138173	10	544



9048-350	7314150180349	10	544
9048-400	7314150138180	10	544
904T-060-150	7314153019837	5	217
905T-060-100	7314153019844	5	216
9070	7314150100170	5	38
9070 P	7314150103416	5	38
9070 P-1	7314150239610	1	39
9070 PC	7314150103423	5	38
9070C	7314150100187	5	38
9071	7314150100194	5	38
9071 P	7314150103430	5	38
9071 P-1	7314150239627	1	39
9071 PC	7314150103447	5	38
9071C	7314150100200	5	38
9072	7314150055609	5	38
9072 C	7314150055616	5	38
9072 P	7314150056354	5	38
9072 P-1	7314150239634	1	39
9072 PC	7314150056361	5	38
9073	7314150101702	5	38
9073 C	7314150101719	3	38
9073 P	7314150101726	5	38
9073 P-1	7314150239641	1	39
9073 PC	7314150101733	3	38
91-023-5P	7311518032593	1	138
91-027-5P	7311518032616	1	138
91-143-100P	7311518224363	1	138
91-143-25P	7311518266578	1	138
91-143-5P	7311518032630	1	138
91-148-5P	7311518032654	1	138
91-223-5P	7311518032661	1	138
91-226-5P	7311518032685	1	138
91-233-5P	7311518260057	1	138
91-243-5P	7311518032692	1	138
91-2PW-5P	7311518260163	1	138
91-3PM-5P	7311518260156	1	138
91-412-5P	7311518260040	1	138
91-433-5P	7311518260101	1	138
91-434-5P	7311518260026	1	138
91-443-5P	7311518032722	1	138
91-444-5P	7311518260033	1	138
91-4PWM-5P	7311518260170	1	138
91-502-5P	7311518032746	1	138
91-512-25P	7311518266592	1	138
91-512-5P	7311518032753	1	138
91-517-5P	7311518032777	1	138
91-522-5P	7311518032784	1	138
91-611-5P	7311518260071	1	138
91-612-5P	7311518032814	1	138
91-622-5P	7311518260088	1	138
91-623-5P	7311518260064	1	138
91-7V1-5P	7311518260118	1	138
91-METAL-10P	7314150449477	1	138
91-MIXED-10P	7314150449491	1	138
91-WOOD-10P	7314150449446	1	138
91C	7314150182381	5	40
92-001-1P	7314150474998	90	140
92-106-1P	7314150474899	90	139
92-113-1P	7314150474912	90	140
92-118-1P	7314150474950	90	140
92-133-1P	7314150474134	70	139
92-133-3P	7314150474158	46	139
92-136-1P	7314150474783	20	141
92-136-G120-5P	7314150498079	10	141
92-136-G240-5P	7314150498116	10	141
92-136-G40-5P	7314150497997	10	141
92-136-G80-5P	7314150498031	10	141
92-137-1P	7314150475070	50	141
92-137-G120-5P	7314150498093	10	141
92-137-G240-5P	7314150498130	10	141
92-137-G40-5P	7314150498017	10	141
92-137-G80-5P	7314150498055	10	141
92-157-1P	7314150474820	70	139
92-160-1P	7314150474172	70	139
92-160-3P	7314150474196	46	139
92-165-1P	7314150475018	90	140
92-166-1P	7314150474974	50	140
92-174-1P	7314150474936	90	140
92-205-1P	7314150474219	70	139
92-205-3P	7314150474356	46	139
92-221-1P	7314150474721	70	139
92-222-1P	7314150474592	70	139
92-222-3P	7314150474370	46	139
92-223-1P	7314150474684	70	139
92-223-3P	7314150474400	46	139
92-225-1P	7314150474707	70	139
92-226-1P	7314150475032	90	140
92-228-1P	7314150474745	70	139
92-229-1P	7314150474769	70	139
92-236-1P	7314150474806	70	139
92-245-1P	7314150475056	90	140
92-251-1P	7314150474868	70	140
92-WM-SET-8P	7314150486830	34	140
9210	7311518278182	1	640
9210-1	7311518278212	1	640
9210-10	7311518278229	1	640



9210-1060177	7311518295424	1	641
9210-1060238	7311518295394	20	641
9210-1230219	7311518295387	20	641
9210-1230235	7311518295325	1	640
9210-1320281	7311518295431	10	641
9210-1640142	7311518295356	1	640
9210-1690148	7311518295332	1	640
9210-1700118	7311518295363	1	641
9210-1710266	7311518295417	1	641
9210-1720100	7311518295295	1	640
9210-1730107	7311518295349	10	640
9210-1770106	7311518295370	10	641
9210-1830137	7311518295400	1	641
9210-20	7311518278236	1	640
92C	7314150182398	5	40
93C	7314150182404	5	40
94C	7314150182411	5	40
9500DZ-1.13/16	7314150227501	1	101
9500DZ-1.5/8	7314150227495	1	101
9500DZ-1.7/8	7314150227518	1	101
9500DZ-2	7314150227525	1	101
9500DZ-2.1/2	7314150227570	1	101
9500DZ-2.1/4	7314150227556	1	101
9500DZ-2.1/8	7314150227532	1	101
9500DZ-2.15/16	7314150227617	1	101
9500DZ-2.3/16	7314150227549	1	101
9500DZ-2.3/4	7314150227600	1	101
9500DZ-2.3/8	7314150227563	1	101
9500DZ-2.5/8	7314150227594	1	101
9500DZ-2.9/16	7314150227587	1	101
9500DZ-3	7314150227624	1	101
9500DZ-3.1/8	7314150227631	1	101
9500SM-41	7314153013699	1	101
9500SM-46	7314153013705	1	101
9500SM-50	7314153013712	1	101
9500SM-54	7314153013729	1	101
9500SM-55	7314153013736	1	101
9500SM-58	7314153013743	1	101
9500SM-60	7314153013750	1	101
9500SM-63	7314153013767	1	101
9500SM-65	7314153013774	1	101
9500SM-67	7314153013781	1	101
9500SM-70	7314153013798	1	101
9500SM-71	7314153013804	1	101
9500SM-75	7314153013811	1	101
9500SM-77	7314153013828	1	101
9500SM-80	7314153013835	1	101
9500SM-82	7314153013842	1	101
9505-3400	7314150125517	1	114
9505-TM	7314150125487	1	114
95155B-3000	7314150415410	1	114
9525-10	7311518031817	1	156
9525-3400	7314150125524	1	114
9525-7	7311518031800	1	156
9525CR-4000	7314150415465	1	114
9526B-4500	7314150415427	1	114
9527CR-2000	7314150415458	1	114
9528-MD-15-45	7311518007447	10	155
9540DZ	7314150414048	1	78
9540DZL	7314150414055	1	78
9540MB	7314153014108	1	77
9540MBL	7314153014115	1	77
9550N	7314150424160	1	102
9550N-SPARE	7314150424153	1	102
9550N/A	7314150424146	1	102
9550N/B	7314150424788	1	102
9555	7314153014047	1	101
9555AB	7314153014061	1	101
956	7314150025190	1	572
9560AB	7314153014078	1	101
9563AB	7314153014085	1	101
9565AB	7314153014092	1	102
9566A	7314150220618	1	101
9572	7314150178599	5	40
9572-200	7311518004231	20	544
9572-250	7311518004248	20	544
9574-200	7314150138197	10	544
9574-250	7314150138203	10	544
9574-300	7314150180356	10	544
9575-250	7314150185894	6	544
95C	7314150182428	1	40
960100010	8413345031073	1	461
960100020	8413345031080	1	461
960100030	8413345031097	1	461
960100050	8413345031103	1	461
960100060	8413345031110	1	461
9625-6.35QC	7314150441716	1	156
9625-9500	7314150125555	1	114
96255CR-7000	7314150415489	1	114
9626-10	7314150388844	1	154
9626-11	7314150388851	1	154
9626-12	7314150388868	1	154
9626-13	7314150388875	1	154
9626-14	7314150388882	1	154
9626-15	7314150444526	1	154
9626-16	7314150388899	1	154



9626-18	7314150388905	1	154
9626-20	7314150388912	1	154
9626-22	7314150388929	1	154
9626-23	7314150388936	1	154
9626-24	7314150388943	1	154
9626-25	7314150388950	1	154
9626-26	7314153024237	1	154
9626-28	7314150388967	1	154
9626-30	7314150388974	1	154
9626-32	7314150388981	1	154
9626-35	7314150444533	1	154
9626-6	7314150388806	1	154
9626-7	7314150388813	1	154
9626-8	7314150388820	1	154
9626-9	7314150388837	1	154
9627-10-460	7314150389018	1	154
9627-12-460	7314150389025	1	154
9627-14-460	7314150389032	1	154
9627-16-460	7314150389049	1	154
9627-18-460	7314150389056	1	154
9627-20-460	7314150389063	1	154
9627-22-460	7314150389070	1	154
9627-24-460	7314150389087	1	154
9627-26-460	7314150389094	1	154
9627-28-460	7314150389100	1	154
9627-30-460	7314150389117	1	154
9627-32-460	7314150389124	1	154
9627-6-460	7314150388998	1	154
9627-8-460	7314150389001	1	154
9629-10	7314150388479	1	155
9629-12	7314150388486	1	155
9629-13	7314150440238	1	155
9629-14	7314150388493	1	155
9629-16	7314150388509	1	155
9629-17	7314150440245	1	155
9629-18	7314150388516	1	155
9629-19	7314150440252	1	155
9629-20	7314150388523	1	155
9629-22	7314150388530	1	155
9629-24	7314150388547	1	155
9629-25	7314150388554	1	155
9629-26	7314150388561	1	155
9629-28	7314150388578	1	155
9629-30	7314150388585	1	155
9629-32	7314150388592	1	155
9629-35	7314150440269	1	155
9629-36	7314150388608	1	155
9629-38	7314150388615	1	155
9629-40	7314150388622	1	155
9629-6	7314150388417	1	155
9629-8	7314150388462	1	155
9629-SET-8	7314150441648	12	155
9631-10-400	7314150388684	1	155
9631-12-400	7314150388691	1	155
9631-13-400	7314150447572	1	155
9631-14-400	7314150388707	1	155
9631-16-400	7314150388714	1	155
9631-18-400	7314150388721	1	155
9631-19-400	7314150447589	1	155
9631-20-400	7314150388738	1	155
9631-22-400	7314150388745	1	155
9631-24-400	7314150388752	1	155
9631-25-400	7314150432066	1	155
9631-28-400	7314150388776	1	155
9631-30-400	7314150388783	1	155
9631-32-400	7314150388790	1	155
9631-35-400	7314150447596	1	155
9631-38-400	7314150447602	1	155
9631-6-400	7314150388646	1	155
9631-8-400	7314150388677	1	155
9646-10	7314150388264	1	155
9646-10-250	7314150388387	1	155
9646-11	7314150388288	1	155
9646-12	7314150388295	1	155
9646-12-250	7314150388400	1	155
9646-13	7314150388301	1	155
9646-14	7314150388318	1	155
9646-15	7314150388325	1	155
9646-16	7314150388332	1	155
9646-18	7314150388349	1	155
9646-20	7314150388356	1	155
9646-3	7314150388189	1	155
9646-4	7314150388202	1	155
9646-5	7314150388219	1	155
9646-6	7314150388226	1	155
9646-6-250	7314150388363	1	155
9646-7	7314150388233	1	155
9646-8	7314150388240	1	155
9646-8-250	7314150388370	1	155
9646-9	7314150388257	1	155
9646-SET-5	7314150441686	1	155
9646-SET-8	7314150441693	1	155
9656-SET-6	7314150486953	1	155
96C	7314150134120	1	40
97-1	7314150366637	1	117
97-1/2	7314150366545	1	117





97-1/4	7314150366507	1	117
97-10	7314150366286	1	117
97-11	7314150366293	1	117
97-11/16	7314150366583	1	117
97-12	7314150366309	1	117
97-13	7314150366316	1	117
97-13/16	7314150366606	1	117
97-14	7314150366323	1	117
97-15	7314150366330	1	117
97-15/16	7314150366620	1	117
97-16	7314150366347	1	117
97-17	7314150366354	1	117
97-17/32	7314150366552	1	117
97-18	7314150366361	1	117
97-19	7314150366378	1	117
97-21	7314150366385	1	117
97-22	7314150349722	1	117
97-24	7314150357048	1	117
97-27	7314150366392	1	117
97-3/4	7314150366590	1	117
97-3/8	7314150366521	1	117
97-30	7314150366408	1	117
97-32	7314150366415	1	117
97-5/16	7314150366514	1	117
97-5/8	7314150366576	1	117
97-7	7314150366255	1	117
97-7/16	7314150366538	1	117
97-7/8	7314150366613	1	117
97-8	7314150366262	1	117
97-9	7314150366279	1	117
97-9/16	7314150366569	1	117
9710-10-175	7314151785789	5	217
9710-3.5-75	7314151785192	10	217
9710-5.5-100	7314151785352	10	217
9710-6.5-125	7314151785437	10	217
9710-8-150	7314151785512	5	217
9710/S6	7314151802301	1	217
9715-14-250	7314153010148	5	218
9733	7314150103256	1	257
9778-1	7314151793524	10	217
9778-2	7314151793531	10	217
9778-3	7314151793548	5	217
9778PZD-1	7314151823535	10	217
9778PZD-2	7314151823542	10	217
97C	7314150128211	1	40
98-1/2	7314150367481	1	118
98-1/4	7314150367443	1	118
98-10	7314150367320	1	118
98-11	7314150367337	1	118
98-11/16	7314150367511	1	118
98-12	7314150367344	1	118
98-13	7314150367351	1	118
98-13/16	7314150367535	1	118
98-14	7314150367368	1	118
98-15	7314150367375	1	118
98-16	7314150367382	1	118
98-17	7314150367399	1	118
98-18	7314150367405	1	118
98-19	7314150367412	1	118
98-21	7314150367429	1	118
98-22	7314150367436	1	118
98-3/4	7314150367528	1	118
98-3/8	7314150367467	1	118
98-5/16	7314150367450	1	118
98-5/8	7314150367504	1	118
98-7	7314150367290	1	118
98-7/16	7314150367474	1	118
98-7/8	7314150367542	1	118
98-8	7314150367306	1	118
98-9	7314150367313	1	118
98-9/16	7314150367498	1	118
981001100	7314150219902	1	450
982000170	7314150219926	1	464
982000320	7314150219919	1	464
982000350	7314150219933	1	464
983000320	7314150219940	1	441
983100320	7314150219964	1	441
984010320	7314150219971	1	441
9841	7314150107445	1	465
9848	7314150111015	1	465
98505	7314150216321	5	215
9852	7314150114092	1	465
9853	7314150103287	1	258
9855	7314150111848	1	655
9857	7314150114283	1	655
9858	7314150111862	1	655
9859	7314150113057	1	655
9860	7314150522859	1	655
9861	7314150522873	1	655
9862	7314150522897	1	655
9863	7314150522910	1	655
9873	7314150058082	1	258
9883	7314150043293	1	571
9897	7314150058068	1	259
9897G/3	7314150470020	1	259
9897S/3	7314150470044	1	503



99-1/2	7314150368150	1	118
99-10	7314150368013	1	119
99-11	7314150368020	1	119
99-11/16	7314150368181	1	119
99-12	7314150368037	1	119
99-13	7314150368044	1	119
99-14	7314150368051	1	119
99-16	7314150368068	1	119
99-17	7314150368075	1	119
99-18	7314150368082	1	119
99-19	7314150368099	1	119
99-21	7314150368105	1	119
99-22	7314150368112	1	119
99-24	7314150368129	1	119
99-3/4	7314150368198	1	119
99-3/8	7314150368136	1	118
99-5/8	7314150368174	1	119
99-7/16	7314150368143	1	118
99-9/16	7314150368167	1	119
9938	7314150056491	1	251
9A-14	7314150368204	1	119
9B-1/4	7314150366071	1	116
9B-5/16	7314150366088	1	116
9F-1/2	7314150366194	1	116
9F-1/4	7314150366170	1	116
9F-3/8	7314150366187	1	116
9P-1/2	7314150366057	1	116
9P-1/4	7314150366033	1	116
9P-3/8	7314150366040	1	116
9Q-1/2	7314150366019	1	116
9Q-1/4	7314150365999	1	116
9Q-3/8	7314150366002	1	116
9R-1/2	7314150365913	1	115
9R-1/4	7314150365890	1	115
9R-3/8	7314150365906	1	115
9T-1/2	7314150366118	1	116
9T-1/4	7314150366095	1	116
9T-3/8	7314150366101	1	116
9W	7314150354399	1	119
A0313M03	7311518023706	1	144
A0313M03E	7311518192150	1	144
A0313M03X	7311518182038	1	144
A0313M03XE	7311518181475	1	144
A0313M03XE-60	7311518184513	1	144
A0313M03XE-80	7311518201357	1	144
A0314I03	7314150501243	5	147
A0613M03X	7311518197872	1	144
A0616AL06E	7311518181802	1	145
A0616M06	7311518023737	1	144
A0616M06E	7311518023751	1	144
A0616M06X	7311518023768	1	144
A0616M06XE	7311518181468	1	144
A0618I06	7314150501267	5	147
A0618S06E	7314150501786	5	146
A0625M06X	7311518197780	1	146
A0820M06	7311518023805	1	144
A0820M06E	7311518023829	1	144
A0820M06X	7311518023836	1	144
A0820M06XE	7311518181994	1	144
A1020I06	7314150501304	5	147
A1020M06	7311518023874	1	144
A1020M06E	7311518023898	1	144
A1020M06X	7311518023904	1	144
A1020M06XE	7311518182007	1	144
A1020S06	7314150501335	5	146
A1020S06E	7314150501793	5	146
A1225AL06E	7311518187620	1	145
A1225AL08E	7311518181819	1	145
A1225I06	7314150506729	5	147
A1225M06	7311518023942	1	144
A1225M06E	7311518023966	1	144
A1225M06X	7311518023973	1	144
A1225M08	7311518100506	1	144
A1225M08E	7311518100520	1	144
A1225M08X	7311518187989	1	144
A1225M08XE	7311518192174	1	144
A1225S06	7314150501427	5	146
A1225S06E	7314150501809	5	146
A1625AL08XE	7311518244033	1	145
A1625M06	7311518192181	1	144
A1625M06X	7311518187361	1	144
A1625M06XE	7311518187354	1	144
A1625M08	7311518100568	1	144
A1625M08E	7311518100582	1	144
A1625M08X	7311518100599	1	144
A1625M08XE	7311518182021	1	144
A6700DM-10	7314151821722	5	79
A6700DM-11	7314151821739	5	79
A6700DM-12	7314151821746	5	79
A6700DM-13	7314151821753	5	79
A6700DM-14	7314151821760	5	79
A6700DM-5	7314150220632	5	79
A6700DM-5.5	7314151821678	5	79
A6700DM-6	7314151821685	5	79
A6700DM-7	7314151821692	5	79
A6700DM-8	7314151821708	5	79



A6700DM-9	7314151821715	5	79
A6700DZ-1/2	7314151751883	5	79
A6700DZ-1/4	7314151751371	5	79
A6700DZ-11/32	7314151819842	5	79
A6700DZ-3/16	7314151751029	5	79
A6700DZ-3/8	7314151751616	5	79
A6700DZ-5/16	7314151751531	5	79
A6700DZ-7/16	7314151819859	5	79
A6700DZ-7/32	7314151751296	5	79
A6700DZ-9/16	7314151751968	5	79
A6700DZ-9/32	7314151751456	5	79
A6709M-2.5	7314151753740	1	83
A6709M-3	7314151753825	1	83
A6709M-4	7314151754129	1	83
A6709M-5	7314151754471	1	83
A6709M-6	7314151754556	1	83
A6709MZ/9	7314150512096	1	68
A6709Z-1/8	7314151755447	1	83
A6709Z-3/16	7314151755874	1	83
A6709Z-5/32	7314151755799	1	83
A6709Z-9/64	7314151755522	1	83
A6710DM-10	7314151756765	1	80
A6710DM-11	7314151756840	1	80
A6710DM-12	7314151756925	1	80
A6710DM-13	7314151757069	1	80
A6710DM-14	7314151757144	1	80
A6710DM-5.5	7314151756178	1	80
A6710DM-6	7314151756253	1	80
A6710DM-7	7314151756338	1	80
A6710DM-8	7314151756413	1	80
A6710DM-9	7314151756680	1	80
A6710DZ-1/2	7314151820466	1	80
A6710DZ-1/4	7314151757229	1	80
A6710DZ-11/32	7314151757571	1	80
A6710DZ-3/16	7314151820435	1	80
A6710DZ-3/8	7314151757656	1	80
A6710DZ-5/16	7314151757496	1	80
A6710DZ-7/16	7314151757731	1	80
A6710DZ-7/32	7314151820442	1	80
A6710DZ-9/16	7314151820473	1	80
A6710DZ-9/32	7314151820459	1	80
A6716DM	7314151820824	1	65
A6716DZ	7314151820831	1	67
A6718DZ	7314150312450	1	68
A6800DM-10	7314151821845	1	79
A6800DM-11	7314151821852	1	79
A6800DM-12	7314151821869	1	79
A6800DM-13	7314151821876	1	79
A6800DM-14	7314151821883	1	79
A6800DM-4	7314151821777	1	79
A6800DM-5	7314151821784	1	79
A6800DM-5.5	7314151821791	1	79
A6800DM-6	7314151821807	1	79
A6800DM-7	7314151821814	1	79
A6800DM-8	7314151821821	1	79
A6800DM-9	7314151821838	1	79
A6800DZ-1/2	7314151758899	1	80
A6800DZ-1/4	7314151758387	1	80
A6800DZ-11/32	7314151803872	1	80
A6800DZ-3/16	7314151758035	1	80
A6800DZ-3/8	7314151758622	1	80
A6800DZ-5/16	7314151758547	1	80
A6800DZ-7/16	7314151803889	1	80
A6800DZ-7/32	7314151758110	1	80
A6800DZ-9/16	7314151758974	1	80
A6800DZ-9/32	7314151758462	1	80
A6800SM-10	7314150360147	1	80
A6800SM-11	7314150360154	1	80
A6800SM-12	7314150360161	1	80
A6800SM-13	7314150360178	1	80
A6800SM-14	7314150360185	1	80
A6800SM-15	7314150360192	1	80
A6800SM-4	7314150360208	1	80
A6800SM-4.5	7314150360215	1	80
A6800SM-5	7314150360222	1	80
A6800SM-6	7314150360239	1	80
A6800SM-7	7314150360246	1	80
A6800SM-8	7314150360253	1	80
A6800SM-9	7314150360260	1	80
A6800SZ-1/8	7314150360277	1	80
A6800SZ-5/32	7314150360284	1	80
A7400DM-10	7314151819972	5	85
A7400DM-11	7314151819989	5	85
A7400DM-12	7314151819996	5	85
A7400DM-13	7314151820008	5	85
A7400DM-14	7314151820015	5	85
A7400DM-15	7314151820022	5	85
A7400DM-16	7314151820039	5	85
A7400DM-17	7314151820046	5	85
A7400DM-18	7314151820053	5	85
A7400DM-19	7314151820060	5	85
A7400DM-20	7314151820077	5	85
A7400DM-21	7314151820084	5	85
A7400DM-22	7314151820091	5	85
A7400DM-24	7314150386123	5	85
A7400DM-6	7314150118212	5	85



A7400DM-7	7314150118229	5	85
A7400DM-8	7314150118236	5	85
A7400DM-9	7314151819965	5	85
A7400DZ-1/2	7314151759780	5	86
A7400DZ-1/4	7314151759193	5	86
A7400DZ-11/16	7314151819897	5	86
A7400DZ-13/16	7314151819910	5	86
A7400DZ-17/32	7314151819866	5	86
A7400DZ-19/32	7314151819873	5	86
A7400DZ-3/4	7314151819903	5	86
A7400DZ-3/8	7314151759438	5	86
A7400DZ-5/16	7314151759278	5	86
A7400DZ-5/8	7314151819880	5	86
A7400DZ-7/16	7314151759513	5	86
A7400DZ-7/8	7314151819927	5	86
A7400DZ-9/16	7314151759865	5	86
A7402DM-10	7314151820138	5	86
A7402DM-11	7314151820145	1	86
A7402DM-12	7314151820152	1	86
A7402DM-13	7314151820169	1	86
A7402DM-14	7314151820176	1	86
A7402DM-15	7314151820183	1	86
A7402DM-16	7314151820190	1	86
A7402DM-17	7314151820206	1	86
A7402DM-18	7314151820213	1	86
A7402DM-19	7314151820220	1	86
A7402DM-21	7314150385881	1	86
A7402DM-7	7314150220243	1	86
A7402DM-8	7314150220250	1	86
A7402DM-9	7314150220267	1	86
A7402DZ-1/2	7314151760526	1	86
A7402DZ-1/4	7314151759940	1	86
A7402DZ-11/16	7314151820114	1	86
A7402DZ-13/16	7314153003027	1	86
A7402DZ-19/32	7314153003041	1	86
A7402DZ-3/4	7314151820121	1	86
A7402DZ-3/8	7314151760366	1	86
A7402DZ-5/16	7314151760014	1	86
A7402DZ-5/8	7314151820107	1	86
A7402DZ-7/16	7314151760441	1	86
A7402DZ-7/8	7314153003034	1	86
A7402DZ-9/16	7314151760793	1	86
A7410DZ-1/2	7314153006301	1	86
A7410DZ-11/16	7314153006332	1	86
A7410DZ-3/4	7314153006349	1	86
A7410DZ-3/8	7314153006288	1	86
A7410DZ-5/16	7314153006271	1	86
A7410DZ-5/8	7314153006325	1	86
A7410DZ-7/16	7314153006295	1	86
A7410DZ-9/16	7314153006318	1	86
A7435DME	7314153015006	1	70
A7440DME	7314153015419	1	70
A7535DZE	7314153015013	1	71
ADJUST 3	7314150103515	1	39
ADJUST 3-90	7314150236336	1	38
ADJUST 9031/29	7314150302925	3	39
AP-234-F	7311518289027	2	628
AP-3M	7311518152062	1	626
AP-5M	7311518152079	1	626
APB260	7314150389162	10	612
APB360	7314150389186	10	612
AS-1200	7314150321520	3	545
AS-C33-JT-F	7314150341672	15	636
AS-C36-JT-M	7311518337490	15	636
AS-C39-JT-C	7314150341542	15	636
AS-C45-JT-C	7314150341559	15	636
ASP-1850	7311518337124	1	627
ASP-1850G	7311518337131	1	627
ASP-AS	7311518337377	6	627
ASP-AS-C33-JT-F	7314150341665	5	629
ASP-AS-C36-JT-M	7314150340590	5	629
ASP-AS-C39-JT-C	7314150341535	5	629
ASP-AS-C45-JT-C	7314150341566	2	629
ASP-AS-HOOK	7311518337582	4	627
ASP-ATP	7311518337384	6	627
ASP3740-C36JTM	7314150341818	1	630
ASP3740-C39JTC	7314150353347	1	630
ASP3740-C45JTC	7314150353354	1	630
ASP3740-P3437	7314150341801	1	628
ATP-110-210	7311518337575	1	626
ATP-200-350	7311518347062	1	626
ATP-200-500	7311518347055	1	626
ATP-230-410	7311518337599	2	627
AUTO	7314150438082	1	375
B141.007.075	7314150278404	5	206
B141.008.075	7314150278411	5	206
B141.009.075	7314150278428	5	206
B141.010.075	7314150278435	5	206
B141.015.100	7314150278442	5	206
B141.020.100	7314150278459	5	206
B141.025.125	7314150278466	5	206
B141.027.125	7314150278473	5	206
B141.030.150	7314150278480	5	206
B141.040.150	7314150278497	5	206
B142.000.075	7314150278718	10	496
B142.001.080	7314150278725	10	496





B142.001.150	7314150343188	10	496
B142.002.100	7314150278732	10	496
B142.002.175	7314150343195	10	496
B142.003.150	7314150278749	10	496
B143.020.100	7314150278510	5	206
B143.025.100	7314150278503	10	206
B143.030.100	7314150278527	10	206
B143.040.100	7314150278534	10	206
B143.050.100	7314150278541	10	206
B143.060.125	7314150278558	10	206
B143.080.150	7314150278565	5	206
B144.001.100	7314150278787	5	206
B144.002.125	7314150278794	5	206
B144.003.150	7314150278800	5	206
B145.006.100	7314150278756	5	207
B146.006.100	7314150278763	5	207
B147.001.400	7314150285594	1	371
B147.003.400	7314150285600	1	371
B148.001.080	7314150314522	10	496
B148.002.100	7314150314539	10	496
B149.001.080	7314150314546	10	496
B149.002.100	7314150314553	10	496
B150.010.100	7314150343126	10	496
B150.015.125	7314150343133	10	496
B150.020.125	7314150343140	10	496
B150.025.150	7314150343157	10	496
B190.040.075	7314150277810	10	204
B190.040.100	7314150277827	10	204
B190.055.100	7314150277834	10	204
B190.055.125	7314150277841	10	204
B190.065.125	7314150277858	10	204
B190.065.150	7314150277865	10	204
B190.080.150	7314150277872	10	204
B190.080.175	7314150277889	10	204
B190.100.200	7314150277896	10	204
B190.120.250	7314150277902	10	204
B190.140.250	7314150277919	10	204
B191.025.075	7314150277926	10	204
B191.030.075	7314150277933	10	204
B191.030.100	7314150277940	10	204
B191.030.200	7314150277957	10	204
B191.035.100	7314150277964	10	204
B191.040.100	7314150277971	10	204
B191.040.125	7314150277988	10	204
B191.040.250	7314150277995	10	204
B191.055.125	7314150278008	10	204
B191.055.150	7314150278015	10	204
B191.055.300	7314150278022	10	204
B191.065.150	7314150278039	10	204
B191.065.300	7314150278046	10	204
B192.000.075	7314150278084	10	205
B192.000.200	7314150278091	10	205
B192.001.100	7314150278107	10	205
B192.001.250	7314150278114	10	205
B192.002.125	7314150278121	10	205
B192.002.150	7314150442720	10	205
B192.002.300	7314150278138	10	205
B192.003.150	7314150278145	10	205
B192.004.200	7314150278169	10	205
B193.000.075	7314150278190	10	205
B193.001.100	7314150278206	10	205
B193.002.125	7314150278213	10	205
B193.003.150	7314150278220	10	205
B193.004.200	7314150278237	10	205
B194.004.075	7314150278268	10	206
B194.005.075	7314150278275	10	206
B194.006.075	7314150278282	10	206
B194.007.075	7314150278299	10	206
B194.008.075	7314150278305	10	206
B194.009.075	7314150278312	10	206
B194.010.075	7314150278329	10	206
B194.015.100	7314150278336	10	206
B194.020.100	7314150278343	10	206
B194.025.125	7314150278350	10	206
B194.027.125	7314150278367	10	206
B194.030.150	7314150278374	10	206
B194.040.150	7314150278381	10	206
B194.045.150	7314150278398	5	206
B195.001.025	7314150278176	10	205
B195.002.025	7314150278183	10	205
B195.006.050	7314150289493	5	207
B195.040.025	7314150278053	10	204
B195.050.025	7314150278060	10	204
B195.060.025	7314150278077	10	204
B195.901.025	7314150278244	10	205
B195.902.025	7314150278251	10	205
B196.025.075	7314150278589	10	495
B196.030.100	7314150278572	10	495
B196.035.100	7314150278596	10	495
B196.040.100	7314150278602	10	495
B196.055.125	7314150278619	10	495
B196.065.150	7314150278626	10	495
B196.080.175	7314150278633	10	495
B196.100.200	7314150278640	10	495
B196.120.200	7314150278657	10	495
B197.000.075	7314150278664	10	496



B197.001.080	7314150278671	10	496
B197.001.150	7314150343164	10	496
B197.002.100	7314150278688	10	496
B197.002.175	7314150343171	10	496
B197.003.150	7314150278695	10	496
B197.004.200	7314150278701	10	496
B198.040.125	7314150278817	5	207
B198.045.125	7314150278824	5	207
B198.050.150	7314150278831	5	207
B198.055.150	7314150281268	5	207
B198.060.150	7314150281763	5	207
B198.060.150F	7314150281770	5	207
B198.070.150	7314150281787	5	207
B198.070.150F	7314150281794	5	207
B198.080.150	7314150281800	5	207
B198.080.150F	7314150281817	5	207
B198.090.150	7314150281824	5	207
B198.100.150	7314150281831	5	207
B198.110.150	7314150281848	5	207
B198.120.150	7314150281855	5	207
B198.130.150	7314150281862	5	207
B198.140.150	7314150281879	5	207
B199.055.125	7314150281886	5	496
B199.060.125	7314150281893	5	496
B199.070.125	7314150281909	5	496
B199.080.125	7314150281916	5	496
B199.090.125	7314150281923	5	496
B199.100.125	7314150281930	5	496
B199.110.125	7314150281947	5	496
B199.120.125	7314150287741	5	496
B199.130.125	7314150287772	5	496
B219.002	7314150289301	1	200
B219.004	7314150283248	1	200
B219.005	7314150283255	1	201
B219.006	7314150283293	1	202
B219.007	7314150283323	1	202
B219.008	7314150283347	1	203
B219.010	7314150283354	1	204
B219.012	7314150327768	1	200
B219.014	7314150533985	1	200
B219.015	7314150283262	1	201
B219.016	7314150283309	1	202
B219.017	7314150283330	1	202
B219.025	7314150283279	1	201
B219.026	7314150283316	1	202
B219.027	7314150399833	1	203
B219.035	7314150283286	1	201
B219.045	7314150533992	1	201
B219.110	7314150392667	1	203
B219.210	7314150438969	1	203
B220.002	7314150289295	1	496
B220.005	7314150283361	1	497
B220.007	7314150283385	1	497
B220.012	7314150314614	1	496
B220.015	7314150283378	1	497
B220.017	7314150283392	1	497
B220.027	7314150283408	1	497
B400.002	8412814119441	1	608
B400.003	8412814119458	1	608
B400.004	8412814119465	1	608
B400.005	8412814119472	1	608
B400.006	8412814119489	1	608
B400.007	8412814119496	1	608
B400.008	8412814119502	1	609
B400.009	8412814119519	1	609
B400.010	8412814119526	1	609
B400.011	8412814119533	1	609
B400.012	8412814119540	1	609
B400.013	8412814119557	1	609
B400.014	8412814119564	1	609
B400.015	8412814119571	1	609
B400.016	8412814119588	1	609
B400.017	8412814119595	1	609
B400.018	8412814119601	1	609
B400.019	8412814119618	1	609
B400.020	8412814119625	1	609
B400.021	8412814119632	1	609
B400.022	8412814119649	1	609
B400.023	8412814119656	1	609
B400.024	8412814119663	1	609
B400.025	8412814119670	1	609
B400.026	8412814119687	1	609
B400.027	8412814119694	1	609
B400.028	8412814119700	1	609
B400.029	8412814119717	1	609
B400.030	8412814119724	1	609
B400.031	8412814119731	1	609
B400.032	8412814119748	1	609
B400.033	8412814119755	1	609
B400.034	8412814119762	1	609
B400.035	8412814119779	1	609
B400.036	8412814119786	1	609
B400.037	8412814119793	1	609
B400.038	8412814119800	1	609
B400.039	8412814119816	1	609
B400.040	8412814119823	1	609



B400.041	8412814119830	1	609
B400.042	8412814119847	1	609
B400.043	8412814119854	1	609
B400.044	8412814119861	1	609
B400.045	8412814119878	1	609
B400.046	8412814119885	1	609
B400.047	8412814119892	1	609
B400.048	8412814119908	1	609
B400.049	8412814119915	1	609
B400.050	8412814119922	1	609
B705.1/4.125	7314150281978	5	216
BAC007	7314150242337	1	313
BASIC	7314150437436	1	375
BB10	7314150240586	1	338
BBA1224-3200	7314150341955	1	337
BBAGM12-1200	7314150535675	1	337
BBAGM1224-2400	7314150535682	1	337
BBAGMBAT	7314150537709	1	337
BBAGMCAB	7314150537723	1	337
BBAGMCHG	7314150537747	1	337
BBBCAB-AUZ	7314150183944	1	341
BBBCAB-EU	7314150186648	1	341
BBBCAB-UK	7314150183937	1	341
BBC420	7314150243235	1	338
BBC620	7314150243242	1	338
BBCE12-10	7314150330263	2	338
BBCE12-15S	7314150406722	2	338
BBCE12-3	7314150330249	2	338
BBCE12-6	7314150330256	2	338
BBCE12-F100	7314150344710	1	338
BBCE24-10	7314150330287	2	338
BBCEC1	7314150335459	1	340
BBCEC2	7314150337460	1	341
BB CER1	7314150335466	1	340
BB CER2	7314150337484	1	341
BBH12-1200	7314150360734	1	337
BBJL1630	7314150244898	5	338
BBJL2535	7314150209453	1	338
BBJL3545	7314150209460	1	338
BBR100	7314150345922	1	324
BBR110	7314150170562	1	325
BBR1501	7314150439119	24	328
BBR201P6	7314150205752	8	327
BBR201P64014	7314150237852	1	327
BBR201P64016	7314150237753	1	327
BBR201P64018	7314150237760	1	327
BBR201P67814	7314150237777	1	327
BBR201P67816	7314150237784	1	327
BBR201P67818	7314150237791	1	327
BBR202P4	7314150205769	1	327
BBR202P410	7314150207688	1	327
BBR202P414	7314150207695	1	327
BBR202P419	7314150207701	1	327
BBR202P455	7314150231393	1	327
BBR203P9	7314150208081	1	327
BBR203P920	7314150231102	1	327
BBR203P925	7314150231119	1	327
BBR203P927	7314150231126	1	327
BBR203P930	7314150231133	1	327
BBR203P940	7314150231140	1	327
BBR203P945	7314150231157	1	327
BBR203P950	7314150231164	1	327
BBR203P955	7314150231171	1	327
BBR203P960	7314150231188	1	327
BBR204	7314150430635	6	328
BBR210P3	7314150206056	1	327
BBR300P50	7314150269624	4	327
BBR320	7314150169887	1	326
BBR350	7314150169900	1	325
BBR400	7314150345939	1	326
BBR405	7314150435807	20	326
BBR410	7314150345946	24	326
BBR420	7314150403394	50	326
BBR501011	7314150438143	50	325
BBR50121314	7314150438150	50	325
BBR6131	7314150239443	1	328
BBR6135	7314150239450	1	327
BBRAS14	7314150416943	4	325
BBRAS14-01	7314150418060	1	325
BBRAS14-02	7314150418077	1	325
BBRAS14-03	7314150418084	1	325
BBRAS14-04	7314150418091	1	325
BBRAS14-05	7314150418107	1	325
BBRAS14-06	7314150418114	1	325
BBRAS14-07	7314150418121	1	325
BBRAS14-08	7314150418138	1	325
BBRAS14-09	7314150418145	1	325
BBRAS14-10	7314150418152	1	325
BBRAS14-11	7314150418169	1	325
BBRAS14-12	7314150418176	1	325
BBRAS14-13	7314150418183	1	325
BBRAS14-14	7314150418190	1	325
BBRBB12	7314150371297	1	325
BBRFKM1	7314150384938	12	328
BBRPTG1	7314150412617	10	325
BBRS210P	7314150206070	1	327



BBRS210P2	7314150206063	1	327
BBS075	7314150249824	12	344
BBS100	7314150169870	1	348
BBS10001	7314150207183	1	348
BBS10002	7314150207190	1	348
BBS10003	7314150207206	1	348
BBS10004	7314150207213	1	348
BBS10005	7314150207220	1	348
BBS100057	7314150186655	1	348
BBS10006	7314150207237	1	348
BBS10007	7314150207244	1	348
BBS10008	7314150207251	1	348
BBS10009	7314150207268	1	348
BBS10010	7314150207275	1	348
BBS101	7314150243525	1	345
BBS102	7314150243518	1	345
BBS103	7314150243488	1	345
BBS10450	7314150243501	1	345
BBS105	7314150250868	1	345
BBS106	7314150243495	1	345
BBS107	7314150250875	1	345
BBS108	7314150250882	1	345
BBS12SH	7314150243563	1	346
BBS150	7314150169849	1	344
BBS150R	7314150244959	1	345
BBS150S	7314150244973	1	345
BBS150T	7314150244966	1	345
BBS165	7314150205615	10	345
BBS165SP4	7314150205622	50	346
BBS170P13	7314150205608	1	346
BBS170P131	7314150231843	1	346
BBS170P132	7314150231850	1	346
BBS170P133	7314150231867	1	346
BBS170P134	7314150231874	1	346
BBS170P135	7314150231881	1	346
BBS170P136	7314150231898	1	346
BBS170P137	7314150231904	1	346
BBS170P138	7314150231911	1	346
BBS170P139	7314150231928	1	346
BBS200	7314150239498	1	348
BBS20P12	7314150169856	1	348
BBS210	7314150215362	1	348
BBS210U06	7314150217656	1	348
BBS210U08	7314150217663	1	348
BBS210UA06	7314150217670	1	348
BBS210UA08	7314150217687	1	348
BBS210V06	7314150217632	1	348
BBS210V08	7314150217649	1	348
BBS210W06	7314150218738	1	348
BBS210W08	7314150218745	1	348
BBS3BH1	7314150356843	1	344
BBS3BH1-VP	7314150355501	40	344
BBS3UH	7314150242351	1	344
BBS50	7314150169863	1	343
BBSDA	7314150247127	1	347
BBSDC	7314150247158	6	347
BBSDD	7314150247165	1	347
BBSDH	7314150247141	1	347
BBSDHR	7314150249299	1	347
BBSDT	7314150247134	6	347
BBSDW	7314150247110	6	347
BBSH1F	7314150247189	1	346
BBSH1M	7314150247196	1	346
BBSH2C	7314150247202	1	346
BBSH2CA	7314150247219	12	346
BBSH2CP	7314150247226	6	346
BBSH2F	7314150247172	6	346
BBSH3CF	7314150247240	6	346
BBSH3CF30	7314150247264	6	346
BBSH3FS	7314150247257	6	346
BBSH3MF	7314150247233	1	347
BBSHWH1	7314150328932	1	347
BBSS1	7314150247288	1	347
BBSS2	7314150247271	8	347
BBSS2L	7314150247295	1	347
BBT20	7314150166961	1	339
BBT60A	7314150504169	36	339
BBT80	7314150327805	6	339
BCL31B1	7314150389704	1	293
BCL31C1	7314150389742	1	293
BCL31D1	7314150389582	1	291
BCL31D1K1	7314150400843	1	291
BCL31S1	7314150389599	1	291
BCL31S1K1	7314150400836	1	291
BCL31IW1	7314150389551	1	290
BCL31IW1K1	7314150400829	1	290
BCL31R1	7314150389568	1	290
BCL31R1K1	7314150400850	1	291
BCL31SD1	7314150389575	1	291
BCL31SD1K1	7314150402656	1	291
BCL32B1	7314150389711	1	293
BCL32DG1	7314150389605	1	292
BCL32DG1K1	7314150402670	1	292
BCL32G1	7314150389629	1	293
BCL32G1K1	7314150400911	1	292
BCL32IW1	7314150389643	1	290



BCL32IW1K1



BCL32IW1K1	7314150402663	1	290
BCL32RS1	7314150389636	1	292
BCL32RS1K1	7314150400904	1	292
BCL32SP1	7314150389612	1	292
BCL32SP1K1	7314150400898	1	292
BCL33AP1	7314150389650	1	292
BCL33AP1K1	7314150402687	1	292
BCL33B1	7314150389728	1	293
BCL33B3	7314150389735	1	293
BCL33C1	7314150389759	1	293
BCL33C2	7314150389766	1	293
BCL33D1	7314150389681	1	291
BCL33D1K1	7314150400881	1	291
BCL33IW1	7314150389667	1	290
BCL33IW1K1	7314150400867	10	290
BCL33IW2	7314150389674	1	290
BCL33IW2K1	7314150400874	1	290
BDACM1000	7314150500819	30	339
BE-3529	7314151847845	5	536
BE-6400M-4	7314153011145	5	194
BE-6400M-5	7314153011169	5	194
BE-6400M-5.5	7314153011176	5	194
BE-6400M-7	7314153011190	5	194
BE-6902	7314150242641	5	193
BE-6903	7314150242665	5	193
BE-6925	7314150242658	5	193
BE-6990-IP10	7314151846763	1	112
BE-6990-IP10-KL	7314151847531	10	113
BE-6990-IP15	7314151846770	1	112
BE-6990-IP15-KL	7314151847548	10	113
BE-6990-IP20-KL	7314151848668	10	113
BE-6990-IP6	7314151846725	1	112
BE-6990-IP6-KL	7314151847494	10	113
BE-6990-IP7	7314151846732	1	112
BE-6990-IP7-KL	7314151847500	10	113
BE-6990-IP8	7314151846749	1	112
BE-6990-IP8-KL	7314151847517	10	113
BE-6990-IP9	7314151846756	1	112
BE-6990-IP9-KL	7314151847524	10	113
BE-6990-IPSET	7314153019356	1	113
BE-6990TX-T10KL	7314151847760	10	113
BE-6990TX-T15KL	7314151847777	10	113
BE-6990TX-T20KL	7314151848682	10	113
BE-6990TX-T6-KL	7314151847722	10	113
BE-6990TX-T7-KL	7314151847739	10	113
BE-6990TX-T8-KL	7314151847746	10	113
BE-6990TX-T9-KL	7314151847753	10	113
BE-7515	7314150242528	5	192
BE-7520	7314150242535	5	192
BE-7525	7314150242542	5	192
BE-7527	7314150242559	5	192
BE-7530	7314150242566	5	192
BE-7540	7314150242573	5	192
BE-7606	7314151839017	5	195
BE-7607	7314151839024	5	195
BE-7608	7314151839031	5	195
BE-7675	7314150123896	1	228
BE-7715	7314150242580	5	192
BE-7720	7314150242597	5	192
BE-7725	7314150242603	5	192
BE-7727	7314150242610	5	192
BE-7730	7314150242627	5	192
BE-7740	7314150242634	5	192
BE-7803	7314151838867	5	194
BE-7804	7314151838881	5	194
BE-7805	7314151838904	5	194
BE-7806	7314151838928	5	194
BE-7806S	7314150242986	5	492
BE-7807	7314151838935	5	194
BE-7807S	7314150242993	5	492
BE-7808	7314151838942	5	194
BE-7808S	7314150243006	5	492
BE-7809	7314151838959	5	194
BE-7809S	7314150243013	5	492
BE-7810	7314151838966	5	194
BE-7810S	7314150243020	5	492
BE-7811	7314151838973	5	194
BE-7812	7314151838980	5	194
BE-7813	7314151838997	5	194
BE-7814	7314151839000	5	194
BE-7835	7314151838874	5	194
BE-7845	7314151838898	5	194
BE-7855	7314151838911	5	194
BE-7855S	7314150242979	5	492
BE-7907	7314153010964	5	192
BE-7908	7314153010971	5	192
BE-7909	7314153010988	5	192
BE-7910	7314151838799	5	192
BE-7915	7314151838805	5	192
BE-7920	7314151838812	5	192
BE-7925	7314151838829	5	192
BE-7927	7314151838836	5	192
BE-7930	7314151838843	5	192
BE-7940	7314151838850	5	192
BE-8002	7314150242825	5	190
BE-8010	7314150010615	5	190



BE-8010S	7314150033058	5	492
BE-8020	7314150010639	5	190
BE-8020I	7314150270316	5	528
BE-8020L	7314151838591	5	190
BE-8022	7314150242474	5	190
BE-8030	7314150010653	5	190
BE-8030I	7314150270330	5	528
BE-8040	7314150010677	5	190
BE-8040I	7314150270347	5	528
BE-8040S	7314150033089	5	492
BE-8040SL	7314150304578	10	494
BE-8050S	7314150033096	5	492
BE-8050SL	7314150304592	10	494
BE-8065S	7314150033119	5	492
BE-8080-1	7314153010995	5	193
BE-8080-10	7314153011060	5	193
BE-8080-2	7314153011008	5	193
BE-8080-3	7314153011015	5	193
BE-8080-4	7314153011022	5	193
BE-8080-5	7314153011039	5	193
BE-8080-6	7314153011046	5	193
BE-8080-8	7314153011053	5	193
BE-8135TB	7314150275052	10	199
BE-8145TB	7314150275076	10	199
BE-8150	7314150010707	5	190
BE-8150TB	7314150275113	10	199
BE-8155	7314150010721	5	199
BE-8155TB	7314150275090	5	199
BE-8158	7314153010858	5	190
BE-8159	7314153010865	5	190
BE-8160	7314150010745	5	190
BE-8210	7314151838584	5	190
BE-8220	7314150047741	5	190
BE-8220S	7314150048243	5	492
BE-8220SL	7314150304530	10	494
BE-8225	7314150242443	5	190
BE-8230	7314150047758	5	190
BE-8230S	7314150048250	5	492
BE-8230SL	7314150304554	10	494
BE-8235	7314150242450	5	190
BE-8240	7314150047765	5	190
BE-8241	7314150242467	5	190
BE-8241I	7314150270866	5	528
BE-8242	7314153010803	5	190
BE-8250	7314150047772	5	190
BE-8250L	7314151838607	5	190
BE-8251	7314150242481	5	190
BE-8252	7314153010810	5	190
BE-8252I	7314150270361	5	528
BE-8255	7314150047789	5	190
BE-8255S	7314150048281	5	492
BE-8255SL	7314150304615	10	494
BE-8256	7314153010827	5	190
BE-8256TB	7314150275137	10	199
BE-8257	7314153010834	5	190
BE-8258	7314153010841	5	190
BE-8258S	7314150242818	5	492
BE-8258TB	7314150275151	10	199
BE-8259S	7314150242832	5	492
BE-8260	7314150047796	5	190
BE-8262TB	7314150275526	10	199
BE-8330	7314151838614	5	190
BE-8340	7314151838621	5	190
BE-8350	7314151838638	5	190
BE-8355	7314151838652	5	191
BE-8360	7314151838676	5	191
BE-8450	7314151838645	5	190
BE-8455	7314151838669	5	190
BE-8510S	7314150126507	5	492
BE-8510SL	7314150304813	10	494
BE-8520S	7314150126514	5	492
BE-8520SL	7314150304837	10	494
BE-8571	7314150244652	1	197
BE-8572	7314150244669	1	197
BE-8573	7314150244676	1	198
BE-8574	7314150258666	1	198
BE-8575	7314150244638	1	195
BE-8576	7314150245741	1	198
BE-8577	7314151839048	5	195
BE-8600	7314150010769	5	191
BE-8600I	7314150270378	5	528
BE-8600S	7314150033126	5	492
BE-8601	7314151838706	5	191
BE-8602	7314151838713	5	191
BE-8605	7314150242498	5	191
BE-8608	7314150242504	5	191
BE-8610	7314150010776	5	191
BE-8610I	7314150270392	5	528
BE-8610L	7314151838683	5	191
BE-8610S	7314150033133	5	492
BE-8610SL	7314150304639	10	494
BE-8610TB	7314150275199	10	199
BE-8611	7311518292317	5	191
BE-8611S	7314150414703	5	492
BE-8612S	7314150242856	5	492
BE-8620	7314150010783	5	191



BE-8620I	7314150270408	5	528
BE-8620L	7314151838690	5	191
BE-8620S	7314150033140	5	492
BE-8620SL	7314150304653	10	494
BE-8620TB	7314150275212	10	199
BE-8621	7311518292324	5	191
BE-8621S	7314150242863	5	492
BE-8622	7314150242511	5	191
BE-8622S	7314150242870	5	492
BE-8623	7314153010872	5	191
BE-8623I	7314150270415	5	528
BE-8623TB	7314150275236	10	199
BE-8624	7314153010889	5	191
BE-8624TB	7314150275250	10	199
BE-8628	7314153010896	5	191
BE-8629	7314153010902	5	191
BE-8630	7314150010790	5	191
BE-8630S	7314150033157	5	492
BE-8640	7314150010806	5	191
BE-8640S	7314150033164	5	492
BE-8675	7314150123872	1	228
BE-8700-1/4	7314150242689	5	193
BE-8700-3/16	7314150242696	5	193
BE-8700-3/8	7314150242702	5	193
BE-8700-5/16	7314150242719	5	193
BE-8700-5/32	7314150242726	5	193
BE-8700-7/32	7314150242733	5	193
BE-8700-7/64	7314150275878	5	193
BE-8702	7314151838768	5	193
BE-8703	7314150027651	5	193
BE-8703S	7314151839130	5	492
BE-8704	7314150027668	5	193
BE-8704S	7314151839147	5	492
BE-8705	7314150027675	5	193
BE-8705S	7314151839154	5	492
BE-8706	7314150027682	5	193
BE-8706S	7314151839161	5	492
BE-8708	7314150027699	5	193
BE-8708S	7314151839178	5	492
BE-8710	7314150027705	5	193
BE-8710S	7314150126521	5	492
BE-8710SL	7314150304851	10	494
BE-8715	7314150242672	5	193
BE-8720S	7314150126538	5	492
BE-8720SL	7314150304875	10	494
BE-8725	7314151838775	5	193
BE-8725S	7314151839123	5	492
BE-8800	7314150042012	5	191
BE-8800I	7314150270422	5	528
BE-8800S	7314151839055	5	492
BE-8801	7314151838744	5	192
BE-8802	7314151838751	5	192
BE-8810	7314150010813	5	191
BE-8810I	7314150270439	5	528
BE-8810L	7314151838720	5	191
BE-8810S	7314150048298	5	492
BE-8810SL	7314150304677	10	494
BE-8810TB	7314150275274	10	199
BE-8811	7311518292331	5	191
BE-8811S	7314150414710	5	492
BE-8812S	7314150242894	5	492
BE-8820	7314150010820	5	191
BE-8820I	7314150270446	5	528
BE-8820L	7314151838737	5	191
BE-8820S	7314150048304	5	492
BE-8820SL	7314150304691	10	494
BE-8820TB	7314150275298	10	199
BE-8821	7311518292348	5	191
BE-8821S	7314150242900	5	492
BE-8822S	7314150242917	5	492
BE-8823	7314153010919	5	191
BE-8823I	7314150270453	5	528
BE-8823TB	7314150275311	10	199
BE-8824	7314153010926	5	191
BE-8824TB	7314150275335	10	199
BE-8828	7314153010933	5	191
BE-8829	7314153010940	5	191
BE-8830	7314150010837	5	191
BE-8830S	7314150048311	5	492
BE-8840	7314150010844	5	191
BE-8840S	7314151839062	5	492
BE-8865	7314150010851	5	190
BE-8870	7314150010875	5	190
BE-8880	7314150010899	5	190
BE-8890	7314150010905	5	190
BE-8904	7314153010957	5	192
BE-8905	7314153010049	5	192
BE-8905S	7314150242924	5	492
BE-8906	7314150027729	5	192
BE-8906S	7314150242931	5	492
BE-8907	7314150027736	5	192
BE-8907S	7314150242948	5	492
BE-8908	7314150027743	5	192
BE-8908S	7314150242955	5	492
BE-8909	7314150027750	5	192
BE-8909S	7314150242962	5	492



BE-8910	7314150027767	5	192
BE-8910I	7314150270460	5	528
BE-8910S	7314151839079	5	492
BE-8910SL	7314150304714	5	494
BE-8910TB	7314150275359	5	200
BE-8915	7314150027774	5	192
BE-8915I	7314150270477	5	528
BE-8915S	7314151839086	5	492
BE-8915SL	7314150304738	5	494
BE-8915TB	7314150275373	5	200
BE-8920	7314150027781	5	192
BE-8920I	7314150270484	5	528
BE-8920S	7314151839093	5	492
BE-8920SL	7314150304752	5	494
BE-8920TB	7314150275397	5	200
BE-8925	7314150027798	5	192
BE-8925I	7314150270491	5	528
BE-8925S	7314151839109	5	492
BE-8925SL	7314150304776	5	494
BE-8925TB	7314150275410	5	200
BE-8927	7314150027804	5	192
BE-8927TB	7314150275434	5	200
BE-8930	7314150027811	5	192
BE-8930S	7314151839116	5	492
BE-8930SL	7314150304790	5	494
BE-8930TB	7314150275458	5	200
BE-8940	7314150027828	5	192
BE-8940TB	7314150275472	5	200
BE-8945	7314151838782	5	192
BE-8975	7314150056576	6	227
BE-8975B	7314150188741	6	227
BE-8976B	7314150216369	6	228
BE-8980	7314153010681	5	194
BE-8985	7314153010698	5	194
BE-8986	7314150267026	5	194
BE-9001	7311518269005	5	193
BE-9002	7311518269012	5	193
BE-9003	7311518269029	5	193
BE-9100	7314150242757	5	193
BE-9101	7314150242764	5	193
BE-9102	7314150242771	5	193
BE-9103	7314150242788	5	193
BE-9104	7314150242795	5	193
BE-9105	7314150242801	5	193
BE-9575	7314150123841	1	227
BE-9578	7314150123803	1	224
BE-9585	7314150123858	1	227
BE-9586	7314150216000	1	224
BE-9588	7314150123810	1	225
BE-9675	7314150123889	1	227
BE-9676	7314150216017	1	225
BE-9678	7314150123827	1	225
BE-9688	7314150123834	1	225
BE-9765	7314150055128	3	225
BE-9770	7314150027712	3	225
BE-9770I	7314150276332	20	528
BE-9775	7314150056330	3	226
BE-9776	7314150056545	6	224
BE-9776B	7314150216352	6	225
BE-9777	7314150056552	6	224
BE-9777B	7314150188734	6	224
BE-9780	7314150033386	3	226
BE-9785	7314150056347	3	226
BE-9786I	7314150314485	1	529
BE-9787	7314150056569	6	224
BE-9871	7314150234707	1	189
BE-9871SL	7314150470792	1	495
BE-9872	7314150440412	1	189
BE-9872SL	7314150470785	1	495
BE-9875	7314150314444	1	189
BE-9876S	7314150315000	1	494
BE-9877	7314150320745	1	190
BE-9878	7314150186259	1	222
BE-9878SL	7314150321018	1	495
BE-9879	7314150383474	1	189
BE-9880	7314150238569	3	223
BE-9880SL	7314150337651	1	495
BE-9881	7314150043279	1	188
BE-9881I	7314150270507	1	528
BE-9881S	7314151839307	1	493
BE-9881SL	7314150304899	1	495
BE-9881TB	7314150275502	1	198
BE-9882	7314151839284	1	188
BE-9882I	7314150270514	1	528
BE-9882S	7314151839314	1	493
BE-9882SL	7314150304912	1	495
BE-9882TB	7314150275496	1	199
BE-9884	7314150243068	1	188
BE-9884S	7314150236602	1	493
BE-9885	7314150048465	1	188
BE-9885S	7314150126491	1	493
BE-9885TB	7314150275519	1	199
BE-9886	7314150048472	1	188
BE-9887S	7314150244744	1	493
BE-9888S	7314153006158	1	493
BE-9889S	7314150244751	1	493





BE-9890S	7314150237715	1	493
BE-9890SL	7314150315086	1	494
BE-9891SL	7314150321506	1	494
BE-9894SL	7314150321490	1	495
BE1100	7314150205929	8	309
BE110001	7314150230228	1	309
BE110014	7314150230204	1	308
BE110015	7314150230211	1	308
BE1100AC1	7314150230266	1	308
BE1100AC2	7314150333394	1	308
BE1200P6	7314150205516	1	306
BE1200P6AC1	7314150205523	1	306
BE1205	7314150205554	1	306
BE1210P11	7314150209101	1	307
BE1210P1101	7314150269822	1	306
BE1210P1102	7314150269839	1	306
BE1210P1103	7314150269846	1	306
BE1210P9AC1	7314150205547	1	307
BE1300	7314150205578	1	305
BE1300SH	7314150205585	10	305
BE1305P450	7314150206032	1	305
BE1305P450WS01	7314150269228	1	305
BE1305P450WS02	7314150269235	1	305
BE1305P450WS03	7314150269242	1	305
BE1305P450WS04	7314150269327	1	305
BE1305P450WS05	7314150269334	1	305
BE1305P450WS06	7314150269341	1	305
BE1305P450WS07	7314150269358	1	305
BE1305P450WS08	7314150269365	1	305
BE1305P450WS09	7314150269372	1	305
BE1305P450WS10	7314150269310	1	305
BE1305P450WS11	7314150269389	1	305
BE1305P450WS12	7314150269396	1	305
BE1305P450WS13	7314150269402	1	305
BE1305P450WS14	7314150269419	1	305
BE1305P450WS15	7314150269426	1	305
BE1310P4	7314150205707	1	304
BE1310P425	7314150233649	1	304
BE1310P427	7314150233656	1	304
BE1310P429	7314150233663	1	304
BE1310P430	7314150233670	1	304
BE1311P13	7314150235414	1	304
BE1312DNS	7314150450596	12	305
BE1315P7	7314150205776	1	305
BE1315P71	7314150230273	1	305
BE1315P72	7314150230280	1	305
BE1315P73	7314150230297	1	305
BE1315P74	7314150230303	1	305
BE1315P75	7314150230310	1	305
BE1315P76	7314150230327	1	305
BE1315P77	7314150230334	1	305
BE1320S17	7314150415366	10	304
BE13ZL11	7314150239733	1	306
BE1FFWF	7314150403325	12	315
BE1FLD1	7314150250745	1	315
BE1FLD2	7314150250752	1	315
BE1FLD3	7314150250769	1	315
BE1FLDS	7314150250783	1	315
BE1FTW	7314150251209	1	315
BE1GP5	7314150170043	1	306
BE1GP5-T	7314150170050	10	306
BE1GP510	7314150207732	1	307
BE1GP512	7314150207749	1	307
BE1GP514	7314150207756	1	307
BE1GP58	7314150207718	1	307
BE1GP59	7314150207725	1	307
BE1P	7314150170067	1	307
BE1SP14L	7314150170074	1	307
BE1SP16L	7314150492756	10	307
BE1SP1F	7314150435777	12	307
BE1T14	7314150167630	1	307
BE1T16	7314150167647	1	307
BE1T21	7314150167654	1	307
BE1TH-10	7314150343980	5	316
BE1TH-12	7314150343997	5	316
BE1TH-2	7314150343874	10	316
BE1TH-2.5	7314150343881	10	316
BE1TH-3	7314150343898	10	316
BE1TH-3.5	7314150343904	10	316
BE1TH-4	7314150343911	10	316
BE1TH-4.5	7314150343928	10	316
BE1TH-5	7314150343935	10	316
BE1TH-6	7314150343942	10	316
BE1TH-7	7314150343959	10	316
BE1TH-8	7314150343966	10	316
BE1TH-9	7314150343973	10	316
BE1TH-S5	7314150457502	1	315
BE1TH-S6	7314150344017	30	315
BE1TS-10	7314150344062	10	316
BE1TS-11	7314150344079	10	316
BE1TS-12	7314150344086	10	316
BE1TS-13	7314150344093	10	316
BE1TS-14	7314150344109	10	316
BE1TS-15	7314150344116	10	316
BE1TS-16	7314150344123	10	316
BE1TS-17	7314150344130	10	316



BE1TS-18	7314150344147	10	316
BE1TS-19	7314150344154	10	316
BE1TS-20	7314150344161	8	316
BE1TS-21	7314150344178	8	316
BE1TS-22	7314150344185	8	316
BE1TS-24	7314150344192	8	316
BE1TS-6	7314150344024	10	316
BE1TS-7	7314150344031	10	316
BE1TS-8	7314150344048	10	316
BE1TS-9	7314150344055	10	316
BE1TS-S7	7314150344208	1	316
BE200CAB250SH10	7314150165452	1	360
BE200CAB250SH25	7314150165469	1	360
BE200CAB250SH3	7314150165445	1	360
BE200CAB40F1	7314150165391	1	360
BE200CAB55F1	7314150165407	1	360
BE200CAB55F3	7314150165414	1	360
BE200CAB58SR1	7314150165421	1	360
BE200CAB58SR3	7314150165438	1	360
BE200CAB80SR1	7314150165384	1	360
BE200CAB80SR3	7314150165476	1	360
BE200MAG4	7314150245192	1	360
BE200MAG55	7314150165513	1	360
BE200MAG80	7314150165551	1	360
BE200MIR4035	7314150245161	1	360
BE200MIR4055	7314150245185	1	360
BE200MIR5535	7314150165483	1	360
BE200MIR5545	7314150165490	1	360
BE200MIR5555	7314150165506	1	360
BE200MIR8035	7314150165520	1	360
BE200MIR8045	7314150165537	1	360
BE200MIR8055	7314150165544	1	360
BE220	7314150170005	1	360
BE230	7314150182633	1	303
BE239	7314150243143	1	303
BE240	7314150239917	1	303
BE240-CAT	7314150289417	1	303
BE250	7314150169924	1	313
BE251200	7314150249343	1	334
BE2512005	7314150249350	1	333
BE2512008	7314150249367	1	334
BE251A	7314150540136	12	313
BE253	7314150250806	1	313
BE2541	7314150251797	1	314
BE2542	7314150251803	1	314
BE254A	7314150446070	1	314
BE254A-01	7314150453405	1	314
BE256-155	7314150205875	1	314
BE256-178	7314150205882	1	314
BE256-250	7314150205899	1	314
BE256M	7314150205851	1	314
BE256P3	7314150205868	1	314
BE257	7314150205844	8	304
BE25710	7314150230549	1	304
BE25718	7314150230532	1	304
BE2572	7314150230556	1	304
BE2576	7314150230525	1	304
BE258	7314150251780	1	314
BE301	7314150430871	2	335
BE301CM	7314150430888	50	335
BE301CM-01	7314150430956	20	335
BE301CM-02	7314150430963	20	335
BE310	7314150205943	8	336
BE400P24	7314150205806	1	309
BE400P2401	7314150230600	1	310
BE400P2402	7314150230617	1	310
BE400P2403	7314150230624	1	310
BE400P2404	7314150230631	1	310
BE400P2405	7314150230648	1	310
BE400P2406	7314150230655	1	310
BE400P2407	7314150230662	1	310
BE400P2408	7314150230679	1	311
BE400P2409	7314150230686	1	311
BE400P241	7314150230563	1	309
BE400P2410	7314150230693	1	311
BE400P2411	7314150230709	1	311
BE400P2412	7314150230716	1	311
BE400P2413	7314150230723	1	311
BE400P2414	7314150230730	1	311
BE400P2415	7314150230747	1	311
BE400P2416	7314150230754	1	311
BE400P2417	7314150230761	1	312
BE400P2418	7314150230778	1	312
BE400P2419	7314150230785	1	312
BE400P242	7314150230570	1	309
BE400P2420	7314150237647	1	312
BE400P243	7314150230587	1	310
BE400P244	7314150230594	1	310
BE401	7314150240593	1	309
BE410	7314150205813	4	312
BE4101	7314150230792	1	312
BE5008	7314150239344	1	306
BE5008-10	7314150239269	1	306
BE5008-15	7314150239276	1	306
BE5008-20	7314150239283	1	306
BE5008-25	7314150239290	1	306



BE5008-27	7314150239306	1	306
BE5008-30	7314150239313	1	306
BE5008-40	7314150239320	1	306
BE5008-45	7314150239337	1	306
BE500P24	7314150169955	5	303
BE500P2401	7314150209569	1	303
BE500P2402	7314150209682	1	303
BE500P2403	7314150209736	1	303
BE500P2404	7314150209729	1	303
BE500P2405	7314150209613	1	303
BE500P2406	7314150209804	1	303
BE500P2407	7314150209781	1	303
BE500P2408	7314150209743	1	303
BE500P2409	7314150209750	1	303
BE500P2410	7314150209637	1	303
BE500P2411	7314150209644	1	303
BE500P2412	7314150209699	1	303
BE500P2413	7314150209705	1	303
BE500P2414	7314150209798	1	303
BE500P2415	7314150209675	1	303
BE500P2416	7314150209620	1	303
BE500P2417	7314150209583	1	303
BE500P2418	7314150209576	1	303
BE500P2419	7314150209767	1	303
BE500P2420	7314150209590	1	303
BE500P2421	7314150209606	1	303
BE500P2422	7314150209774	1	303
BE500P2423	7314150209668	1	303
BE500P2424	7314150209712	1	303
BE501101	7314150274499	1	296
BE501102	7314150274505	1	296
BE501203	7314150274529	1	296
BE501204	7314150274536	1	296
BE502101	7314150274543	1	296
BE502102	7314150274550	1	297
BE502103	7314150274567	1	297
BE502104	7314150384952	8	296
BE502106	7314150403370	10	296
BE502204	7314150274574	1	297
BE5032	7314150189885	1	312
BE503201	7314150274581	1	297
BE5032H10EL	7314150220953	1	317
BE5032H14	7314150220960	1	316
BE5032M14	7314150220977	1	317
BE5032SQ10	7314150220991	1	312
BE5032SQ8	7314150220984	1	312
BE5032T55EL	7314150220946	1	318
BE504102	7314150274666	1	297
BE504201	7314150274369	1	297
BE5049	7314150169931	5	316
BE504901	7314150184576	1	316
BE504902	7314150184583	1	317
BE5049H10	7314150184705	1	316
BE5049H10L	7314150184712	1	317
BE5049H12	7314150184729	1	316
BE5049H12L	7314150184736	1	317
BE5049H4	7314150184590	1	316
BE5049H4L	7314150184606	1	317
BE5049H5	7314150184613	1	316
BE5049H5L	7314150184620	1	317
BE5049H6	7314150184637	1	316
BE5049H6L	7314150184651	1	317
BE5049H7	7314150184668	1	316
BE5049H7L	7314150184675	1	317
BE5049H8	7314150184682	1	316
BE5049H8L	7314150184699	1	317
BE5049M10	7314150184804	1	317
BE5049M10L	7314150184811	1	317
BE5049M12	7314150184828	1	317
BE5049M12L	7314150184835	1	317
BE5049M5	7314150184743	1	317
BE5049M5L	7314150184750	1	317
BE5049M6	7314150184767	1	317
BE5049M6L	7314150184774	1	317
BE5049M8	7314150184781	1	317
BE5049M8L	7314150184798	1	317
BE5049T	7314150325474	1	318
BE5049T20	7314150216048	1	317
BE5049T20H	7314150184842	1	317
BE5049T20L	7314150184859	1	318
BE5049T25	7314150221011	1	318
BE5049T25H	7314150216055	1	317
BE5049T25L	7314150184866	1	317
BE5049T27	7314150184873	1	318
BE5049T27H	7314150221028	1	318
BE5049T27L	7314150216062	1	317
BE5049T27HL	7314150184880	1	317
BE5049T27L	7314150184897	1	318
BE5049T30	7314150221035	1	318
BE5049T30H	7314150216079	1	317
BE5049T30HL	7314150184903	1	317
BE5049T30L	7314150184910	1	318
BE5049T30HXL	7314150184927	1	318
BE5049T30L	7314150221042	1	318
BE5049T40	7314150216086	1	317
BE5049T40H	7314150184934	1	317



BE5049T40HL	7314150184941	1	318
BE5049T40HXL	7314150185092	1	318
BE5049T40L	7314150221059	1	318
BE5049T45	7314150216093	1	317
BE5049T45H	7314150184958	1	317
BE5049T45HL	7314150184965	1	318
BE5049T45HXL	7314150184972	1	318
BE5049T45L	7314150216123	1	318
BE5049T50	7314150216109	1	317
BE5049T50H	7314150184989	1	317
BE5049T50HL	7314150184996	1	318
BE5049T50L	7314150221066	1	318
BE5049T55	7314150216116	1	317
BE5049T55H	7314150185009	1	317
BE5049T55HL	7314150185016	1	318
BE5049T55L	7314150221073	1	318
BE5049T60	7314150221004	1	317
BE5049T60H	7314150185023	1	317
BE5049T60HL	7314150185030	1	318
BE5049T70HL	7314150185047	1	317
BE5049T80HL	7314150186532	1	318
BE505101	7314150274598	1	298
BE505102	7314150274604	1	298
BE505203	7314150274611	1	298
BE505204	7314150274628	1	298
BE506101	7314150274376	1	298
BE506102	7314150274635	1	298
BE506103	7314150274642	1	299
BE506204	7314150274659	1	299
BE507101	7314150274673	1	299
BE507102	7314150274680	1	299
BE507203	7314150274697	1	299
BE508101	7314150274765	1	300
BE508202	7314150274772	1	300
BE508203	7314150274703	1	300
BE508204	7314150274710	1	300
BE509101	7314150274727	1	300
BE509102	7314150274734	1	300
BE509103	7314150274383	1	301
BE509104	7314150274741	1	301
BE509205	7314150274390	1	301
BE509206	7314150274406	1	301
BE509207	7314150274758	1	301
BE5100	7314150205646	1	303
BE5101	7314150205721	1	317
BE510101	7314150274420	1	301
BE510102	7314150274437	1	301
BE510125	7314150230877	1	312
BE510127	7314150230884	1	312
BE510130	7314150230891	1	312
BE510140	7314150230907	1	313
BE510145	7314150230914	1	313
BE510150	7314150230921	1	313
BE510155	7314150230938	1	313
BE510160	7314150230945	1	313
BE5102	7314150205738	1	308
BE510203	7314150274789	1	302
BE510210	7314150231003	1	308
BE510211	7314150231010	1	308
BE510212	7314150231027	1	308
BE510213	7314150231034	1	308
BE51025	7314150230952	1	308
BE51026	7314150230969	1	308
BE51027	7314150230976	1	308
BE51028	7314150230983	1	308
BE51029	7314150230990	1	308
BE5103	7314150205745	1	302
BE510304	7314150274444	1	308
BE510310	7314150231072	1	308
BE510312	7314150231089	1	308
BE510314	7314150231096	1	308
BE51035	7314150231041	1	308
BE51036	7314150231058	1	308
BE51038	7314150231065	1	308
BE511011	7314150274451	1	302
BE511102	7314150274468	1	302
BE511203	7314150274796	1	302
BE512201	7314150274475	1	304
BE513201	7314150274802	1	302
BE5150P27	7314150205790	1	313
BE5150P271	7314150230808	1	313
BE5150P272	7314150230815	1	313
BE5150P273	7314150230822	1	313
BE5200	7314150205905	1	317
BE52001	7314150230433	1	317
BE52002	7314150230440	1	317
BE52003	7314150230457	1	317
BE523106	7314150178391	1	302
BE530001	7314150205912	1	317
BE5350	7314150206049	5	305
BE5350C1	7314150230389	1	305
BE5350C2	7314150230396	1	305
BE5350C3	7314150230402	1	305
BE5350C4	7314150230419	1	305
BE5350C5	7314150230426	1	305
BE5400P	7314150245086	1	303





BH4S4	7314150237890	6	349
BH4S50	7314150476879	1	349
BH4S6	7314150237906	4	349
BH4S8	7314150237913	4	349
BH5DP1000QA	7314150270224	1	354
BH5SP500QA	7314150270217	1	354
BH5US1000	7314150243174	1	354
BH6AC1-680A	7314150433544	1	355
BH6FC1000	7314150178650	1	355
BH6FC2000	7314150234639	1	355
BH6PC600	7314150234622	1	355
BH7100A	7314150345908	1	341
BH7100SG	7314150299782	1	342
BH715	7314150237555	1	341
BH715-13	7314150239191	1	341
BH720	7314150235650	1	341
BH720-22	7314150236961	1	341
BH720SG	7314150238477	1	342
BH730	7314150235667	1	341
BH730SG	7314150238484	1	342
BH750	7314150235674	1	341
BH750SG	7314150238491	1	342
BH7PS30	7314150474882	2	341
BH8AC1-500	7314150170463	1	313
BH8AC2-500	7314150412532	1	313
BH8AC3-1500A	7314150516391	1	354
BH8AC3-600	7314150351893	1	354
BH8BC1	7314150242276	1	349
BH8BC2	7314150242283	1	349
BH8BC3	7314150242290	10	349
BH8BC4	7314150242306	6	349
BH8BC5	7314150242313	6	349
BH8PR1000	7314150178957	1	349
BH8PR4000	7314150178940	1	349
BH9BJ22SLH	7314150246946	1	352
BH9BJ22SSH	7314150247462	1	352
BH9BJ23SLH	7314150246953	1	352
BH9BJ23SSH	7314150246960	1	352
BH9BJ260	7314150247509	1	352
BH9BJ280	7314150247516	1	352
BHVG15-250	7314150403745	1	355
BHVIS06100	7314150167753	1	332
BHVIS06105	7314150167760	1	332
BHVIS0670	7314150167692	1	332
BHVIS0677	7314150167708	1	332
BHVIS0680	7314150167715	1	332
BHVIS0685	7314150167722	1	332
BHVIS0690	7314150167739	1	332
BHVIS0695	7314150167746	1	332
BHVIS08100	7314150165711	1	332
BHVIS08115	7314150165728	1	332
BHVIS0895	7314150165704	1	332
BHVIS109BPW12	7314150165759	1	332
BHVIS111BPW12	7314150165735	1	332
BHVIS120BPW16	7314150165742	1	332
BHVIS1265	7314150167685	1	332
BHVIS80BPW12	7314150165766	1	332
BHVIS95BPW9	7314150243334	1	332
BKE850901N	7314150449705	10	229
BLBT100	7314150179015	1	343
BLBT100AC1	7314150179022	1	343
BLCR230FR	7314150247356	1	358
BLCR230SC	7314150247349	1	358
BLCR24VCL	7314150247370	1	358
BLCR24VLL	7314150247387	1	358
BLCR400E	7314150247363	1	358
BLCRSC1	7314150247530	1	358
BLCRSC2	7314150247547	1	358
BLE300	7314150227648	1	343
BLE301	7314150227662	1	343
BLE302	7314150227679	1	343
BLE304	7314150249572	1	343
BLE305	7314150339341	1	342
BLEMAT1	7314150477678	1	342
BLEMAT1BT	7314150477685	1	342
BLT550	7314150243556	10	304
BLTFC1	7314150246434	20	358
BLTS10	7314150246427	20	358
BLTS7P	7314150246410	58	358
BMD150	7314150242238	1	342
BMMTRMS1	7314150274024	1	339
BMR240	7314150242245	1	342
BMVAT1000	7314150488360	50	339
BOD101	7314150205967	1	321
BOD1016	7314150169979	1	323
BOD101NWS	7314150269099	1	321
BOD101T	7314150269150	1	324
BOD102	7314150205974	1	321
BOD102NWS	7314150269105	1	321
BOD102T	7314150269167	1	324
BOD103	7314150205981	1	321
BOD103NWS	7314150269112	1	321
BOD103T	7314150269174	1	324
BOD104	7314150205998	1	321
BOD104NWS	7314150269129	1	321
BOD104T	7314150269181	1	324



BOD105	7314150206001	1	321
BOD105NWS	7314150269136	1	321
BOD105T	7314150269198	1	324
BOD106	7314150206018	1	321
BOD106NWS	7314150269143	1	321
BOD106T	7314150269204	1	324
BOD10P64	7314150205950	8	321
BOD2008	7314150169986	1	323
BOD2FS	7314150351879	20	324
BOD301200	7314150169993	1	323
BOD4200	7314150169436	1	323
BOD4500	7314150169443	1	323
BOD54-1	7314150239467	1	324
BOD54-2	7314150239474	1	324
BOD54-3	7314150239481	1	324
BOD5400	7314150169450	1	324
BOD5450	7314150169474	1	324
BOD5HD400	7314150169467	1	324
BOD60	7314150169481	1	324
BOD6080P12	7314150235407	1	322
BOD6080P12-01	7314150235438	1	322
BOD6080P12-02	7314150235445	1	322
BOD6080P12-03	7314150235452	1	322
BOD6080P12-04	7314150235469	1	322
BOD6080P12-05	7314150235476	1	323
BOD6080P12-06	7314150235490	1	323
BOD6080P12-07	7314150235506	1	323
BOD6080P12-08	7314150235513	1	323
BOD6080P12-09	7314150235520	1	323
BOD6080P12-10	7314150235537	1	323
BOD6080P12-11	7314150235544	1	323
BOD70	7314150169498	1	324
BOD8901	7314150169016	1	322
BOD8901AC1	7314150178490	1	322
BOD8902	7314150169023	1	322
BOD8903A	7314150265374	1	322
BOM10X	7314150540549	10	361
BP-40	7314150453085	1	573
BP-40-95	7314150487097	12	573
BP110	7314150135011	1	279
BP111E	7314150235872	12	279
BP115	7314150134991	1	277
BP117	7314150184309	1	277
BP117EH	7314150184316	1	279
BP118	7314150235834	1	277
BP125A	7314150427291	6	285
BP127	7314150137565	1	279
BP12718	8414909179002	1	280
BP127P	7314150427277	1	281
BP204	7314150184286	1	279
BP20410320	7314150185948	1	281
BP20410800	7314150185955	1	281
BP20425180	7314150185924	1	281
BP20425220	7314150185931	1	281
BP204K	7314150184293	1	281
BP204PAD	7314150185917	1	281
BP212	7314150134601	1	281
BP215A	7314150341849	10	285
BP218	7314150170272	1	286
BP219	7314150235889	1	286
BP219L	7314150235896	1	286
BP219V	7314150307197	1	286
BP219XL	7314150427192	10	286
BP222	7314150137572	1	281
BP233	7314150134748	1	283
BP254	7314150137633	1	286
BP255	7314150137640	1	287
BP255T	7314150427307	1	287
BP255T-1	7314150427314	1	287
BP277K	7314150427284	8	285
BP420M	7314150134618	1	278
BP421M	7314150134625	1	278
BP422M	7314150134632	1	278
BP423M	7314150134649	1	278
BP424M	7314150134656	1	278
BP430M	7314150134663	1	278
BP431M	7314150134670	1	278
BP432M	7314150134687	1	279
BP433M	7314150134694	1	279
BP434M	7314150135837	1	279
BP500	7314150137992	1	286
BP51137	7314150134724	1	281
BP601	7314150134526	1	281
BP60102	7314150426669	1	281
BP610	7314150134595	1	282
BP700	7314150134458	20	277
BP704	7314150427130	1	274
BP721	7314150427185	1	277
BP799	7314150134502	1	285
BP79912	7314150134717	1	285
BP809	7314150235841	1	282
BP80950	7314150275564	1	282
BP810	7314150235858	1	282
BP811	7314150235865	1	284
BP814	7314150184262	10	274
BP814A	7314150304349	10	274



BP815



BP815	7314150134311	1	274
BP815K1	7314150181957	1	274
BP815K2	7314150181964	1	274
BP817	7314150134106	1	275
BP820	7314150134465	1	277
BP821	7314150134472	1	277
BP822	7314150134984	1	278
BP822E	7314150184279	10	278
BP823	7314150135004	1	279
BP824	7314150134489	1	283
BP825	7314150134496	1	282
BP826	7314150137459	1	283
BP827	7314150137442	1	283
BP828	7314150427260	1	283
BP830CISB	7314150439799	1	280
BP830ESB	7314150439751	1	280
BP830EWB	7314150439768	1	280
BP830K	7314150427208	4	280
BP830MISB	7314150439782	1	280
BP830SBA	7314150439805	1	280
BP830SSB	7314150439775	1	280
BP830SW	7314150439744	1	280
BP901	7314150336012	1	276
BP901L	7314150336029	1	276
BP905L	7314150336234	2	276
BP905P	7314150336210	2	276
BP905S	7314150336227	2	276
BP909NE	7314150187980	1	285
BP909NF	7314150187973	1	285
BP909TE	7314150187942	1	284
BP909TF	7314150187911	1	284
BP909TH	7314150187959	1	284
BP909TSP	7314150187966	1	285
BP909TTP	7314150187935	1	284
BP909TWF	7314150187928	1	284
BP910	7314150427246	5	284
BP91BL	7314150192779	1	277
BP91BS	7314150192786	1	277
BPA823	7314150427161	1	282
BPGG3515	7314150134823	1	283
BPGG3525A	7314150134830	1	283
BPGG3525B	7314150134847	1	283
BPGG5725	7314150134861	1	284
BPGG9057	7314150134878	1	284
BPPK30	7314150134854	1	283
BPBL00900	7314150358335	5	344
BPBL30900	7314150360451	5	344
BPBL70600	7314150360468	5	344
BPBL90600	7314150358366	5	344
BPBLS4	7314150360475	2	344
BPBSC156	7314150134816	1	283
BPBU18	7314150134755	1	284
BPBU24	7314150134762	1	284
BPBU36	7314150134779	1	284
BPBU60	7314150134786	1	284
BPBU90	7314150134793	1	284
BPC813	7314150296408	10	274
BPC813K1	7314150331253	1	274
BPC814	7314150296392	10	275
BPC815	7314150296385	1	275
BPC815K1	7314150331208	1	275
BPC815K2	7314150331215	1	275
BPC815K3	7314150331222	1	275
BPC815K4	7314150331239	1	275
BPC815K6	7314150331284	1	275
BPC816	7314150296415	10	274
BPC817	7314150296422	4	275
BPC817K1	7314150331260	1	276
BPC817K2	7314150331277	1	276
BPC823	7314150427147	1	282
BPC825	7314150427154	1	282
BPCVB1	7314150384792	6	334
BPG824	7314150427253	10	283
BPH1010A	7314150330010	1	287
BPH1010B	7314150341757	1	287
BPH1310A	7314150330003	1	287
BPHRC1015	7314150247400	1	287
BPHRC1020	7314150247417	1	287
BPHRC1316	7314150247455	1	287
BPHRC815	7314150247394	1	287
BPHRO1315	7314150247431	1	288
BPHRSC	7314150247448	1	287
BPHVLP01	7314150138937	1	285
BPHVLP0112	7314150165872	1	286
BPHVLP0114	7314150165889	1	286
BPHVLP0117	7314150165896	1	286
BPHVLP0120	7314150165902	1	286
BPM917BOOT	7314150281664	1	276
BPM91MK1	7314150186938	1	276
BPM91MK2	7314150186945	1	276
BPN010	7314150219728	1	286
BPN21201	7314150134731	1	282
BPN22201	7314150138074	1	282
BPN251	7314150137589	1	287
BPQC15	7314150360673	12	314
BPR821	7314150427178	1	277



BPSJ	7314150427239	1	288
BPSJL	7314150439812	1	288
BS1000	7314150170081	1	336
BS100001	7314150232819	1	336
BS100002	7314150232826	1	336
BS100003	7314150232833	1	336
BS100004	7314150232840	1	336
BS100005	7314150232857	1	336
BS100006	7314150232864	1	336
BS100007	7314150232871	1	336
BS100008	7314150232888	1	336
BS100009	7314150232895	1	336
BS100010	7314150232901	1	336
BS100011	7314150232918	1	336
BS100012	7314150232925	1	336
BS100013	7314150232932	1	336
BS100014	7314150232949	1	336
BS100015	7314150232956	1	336
BS100016	7314150232963	1	336
BS100017	7314150232970	1	336
BS100018	7314150232987	1	336
BS100019	7314150232994	1	336
BS100020	7314150233007	1	336
BS100021	7314150233014	1	336
BS100022	7314150233021	1	336
BS100023	7314150233038	1	336
BS100024	7314150233045	1	336
BS100025	7314150233052	1	336
BS100026	7314150233069	1	336
BS100027	7314150233076	1	337
BS100028	7314150233083	1	337
BS100029	7314150233090	1	337
BS100030	7314150233106	1	337
BS100031	7314150233113	1	337
BS100032	7314150233120	1	337
BS100033	7314150233137	1	337
BS100034	7314150233144	1	337
BS100035	7314150233151	1	337
BS100036	7314150233168	1	337
BS100037	7314150233175	1	337
BS100038	7314150233182	1	337
BS100039	7314150233199	1	337
BS100PSA1	7314150249282	1	335
BS10AC2	7314150182343	1	336
BS15	7314150206117	1	336
BS15125	7314150231775	1	336
BS15125C	7314150231812	1	336
BS15160	7314150231782	1	336
BS15160C	7314150231829	1	336
BS15212	7314150231799	1	336
BS15212C	7314150231836	1	336
BS1550	7314150231805	1	336
BS25	7314150416103	1	336
BS30AC1	7314150383504	1	336
BS30PG	7314150436644	1	336
BS40VAG	7314150430642	20	334
BS45BMW	7314150430659	20	334
BS52	7314150329212	1	334
BS5228341	7314150329229	1	333
BS5234401	7314150329236	1	333
BS5239451	7314150329243	1	333
BS54	7314150243341	1	334
BS56	7314150430826	6	334
BS618	7314150242368	1	335
BS623	7314150242375	1	335
BSSHE3	7314150251858	1	333
BT10P3	7314150205639	1	344
BT10P325	7314150231706	40	344
BT10P330	7314150231713	1	344
BT10P338	7314150231720	1	344
BT15P5	7314150205837	1	332
BT15P524	7314150231737	1	332
BT15P530	7314150231744	1	332
BT15P532	7314150231751	1	332
BT15P536	7314150342129	1	332
BT20P26	7314150205820	1	335
BT20P49	7314150385041	1	335
BTL 3-13	7314150333349	12	538
BTL 6-13	7314150333356	12	538
BTR 3-13	7314150333332	12	538
BTR 6-13	7314150333363	12	538
BUC100	7314150169962	1	319
BUC110	7314150206025	1	319
BUC50	7314150182329	1	318
BUCKET - 1446-CS	7314150534555	1	585
BUCKET - EMPTY	7314150511037	6	585
BUCKET 1446	7314150436446	75	585
BUCKET-1446-FLOAT	7314150539550	1	585
BUCPE	7314150243259	1	318
BUCPE3SDH	7314153024183	1	318
BUCPE3SH	7314150243471	1	318
BUCPEF	7314150244942	1	318
BUCPEF1	7314150245116	1	318
BWB14	7314150170166	2	334
BWB1418S4	7314150365593	6	342
BWB1922S4	7314150365609	6	342



BWBB	7314150407828	200	330
BWC1	7314150365586	25	331
BWHEHS	7314150251841	1	333
BWHEP	7314150251834	1	333
BWHEPS	7314150264087	1	332
BWHEPSH8	7314150264889	1	333
BWHEPSSH8	7314150264896	1	332
BWHPJ12	7314150403257	4	335
BWHTRS12	7314150384808	15	330
BWMSP15	7314150239740	1	369
BWMSP1501	7314150239757	1	369
BWMSP1502	7314150239764	1	369
BWMSP1503	7314150239771	1	369
BWMSP1504	7314150239788	1	369
BWMSP1505	7314150239795	1	369
BWMSP1506	7314150239801	1	369
BWMSP1507	73141503024176	1	369
BWMSP1508	7314150239818	1	369
BWMSP1509	7314150239825	1	369
BWMSP1510	7314150239832	1	369
BWMSP1511	7314150239849	1	369
BWMSP1512	7314150239856	1	369
BWMSP1513	7314150239863	1	369
BWMSP1514	7314150239870	1	369
BWMSP1515	7314150239887	1	369
BWP150	7314150170159	1	331
BWSH5	7314150251810	2	333
BWSH51	7314150251827	1	333
BWSH8	7314150255191	1	333
BWSHK21	7314150403271	25	329
BWSMB15	7314150365074	25	328
BWSMB17	7314150329656	1	329
BWSS12P3	7314150170128	20	328
BWSS12P317	7314150203451	1	328
BWSS12P317L	7314150330065	1	329
BWSS12P319	7314150203468	1	328
BWSS12P319L	7314150330072	1	329
BWSS12P321	7314150203475	1	328
BWSS12P321L	7314150330089	1	329
BWSS12P3L	7314150330096	1	329
BWSS12P5	7314150170135	1	328
BWSS12P522	7314150203482	1	328
BWSS12P524	7314150203499	1	328
BWTB12P100	7314150329830	1	330
BWTB12P110	7314150329847	1	330
BWTB12P120	7314150329854	1	330
BWTB12P135	7314150329861	1	330
BWTB12P150	7314150329878	1	330
BWTB12P160	7314150329885	1	330
BWTB12P175	7314150329892	1	330
BWTB12P190	7314150329908	1	330
BWTB12P200	7314150329915	1	330
BWTB12P5	7314150329991	1	330
BWTB12P90	7314150329823	1	330
BWTDG1	7314150403400	50	331
BWTPG1	7314150351886	10	331
BWTPMSS4C	7314150347100	25	332
BWTPMSS9	7314150347124	8	331
BWTSP16	7314150170296	1	330
BWTSP1608	7314150203284	1	330
BWTSP1610	7314150203291	1	330
BWTSP1611	7314150203307	1	330
BWTSP1612	7314150203314	1	330
BWTSP1613	7314150203321	1	330
BWTSP1614	7314150203338	1	330
BWTSP1616	7314150203345	1	330
BWTSP1617	7314150203352	1	330
BWTSP1618	7314150203369	1	330
BWTSP1619	7314150203376	1	330
BWTSP1621	7314150203383	1	330
BWTSP1622	7314150203390	1	330
BWTSP1624	7314150203406	1	330
BWTSP1627	7314150203413	1	330
BWTSP317L	7314150335480	1	329
BWTSP319L	7314150335497	1	329
BWTSP321L	7314150335503	1	329
BWTSP3L	7314150335473	1	329
BWTSP6	7314150240043	1	329
BWTSP617	7314150242399	1	329
BWTSP619	7314150242405	1	329
BWTSP621	7314150242412	1	329
BWTSP622	7314150242429	1	329
BWTSP624	7314150242436	1	329
BWTSP7	7314150170302	1	329
BWTSP732	7314150203420	1	330
BWTSP736	7314150203437	1	330
BWTSP741	7314150203444	1	330
BWTVCTT355	7314150347179	1	332
BWXW1	7314150167661	1	328
BWXW2	7314150167678	4	328
BWXW3	7314150214624	1	328
BWXW4	7314150214631	1	328
BZWTB0132450	7314150165674	1	330
BZWTB0132600	7314150165681	1	330
C0312I03	7314150501298	5	147
C0313M03	7311518100636	1	144



C0313M03X	7311518182045	1	144
C0616AL06	7311518181826	1	145
C0616M03X	7311518204679	1	144
C0616M06	7311518100667	1	144
C0616M06X	7311518100681	1	144
C0618I06	7314150501311	5	147
C0618S06	7314150501342	5	146
C0820M06	7311518100711	1	144
C0820M06X	7311518100735	1	144
C1020I06	7314150501373	5	147
C1020M06	7311518100766	1	144
C1020M06X	7311518100780	1	144
C1020S06	7314150501403	5	146
C1225AL06	7311518187637	1	145
C1225I06	7314150506743	5	147
C1225M06	7311518100810	1	144
C1225M06X	7311518100834	1	144
C1225M08X	7311518187996	1	144
C1225S06	7314150501465	5	146
C1625M06	7311518192266	1	144
C1625M06X	7311518187378	1	144
C1625M08	7311518100902	1	144
C1625M08X	7311518100926	1	144
C1997LM/9P	7314150510375	1	225
C1997TORX/9P	7314150510382	1	226
C3140	7314150393312	10	234
C3140IP	7314150391158	10	234
C3230	7314150393329	10	237
C3230IP	7314150391189	10	237
C3330	7314150393336	10	234
C3330IP	7314150391196	10	234
C3330R	7314150393343	10	234
C3330R IP	7314150391202	10	234
C3340R	7314150393350	10	234
C3340R IP	7314150391219	10	234
C3430	7314150393367	10	245
C3430IP	7314150391226	10	245
C3530	7314150393374	10	246
C3530IP	7314150391233	10	246
C3630	7314150393381	10	242
C3630IP	7314150391240	10	242
C3640	7314150393398	10	242
C3640IP	7314150391257	10	242
C3745	7314150393404	10	243
C3745IP	7314150391264	10	243
C3790	7314150393411	10	243
C3790IP	7314150391271	10	243
C3830	7314150393428	10	242
C3830IP	7314150391288	10	242
C3840	7314150393435	10	242
C3840IP	7314150391295	10	242
C3901/3	7314150392797	1	257
C3902/3	7314150399604	1	258
C3903/2-6	7314150466481	1	258
CFP250	7314150400669	6	612
CHALK-BLUE	7314150128686	6	542
CHALK-RED	7314150128709	6	542
CHALK-WHITE	7314150179671	6	542
CHALK-YELLOW	7314150128693	6	542
CL-1221	7314150127122	6	542
CL-1221-SET	7314150188574	4	542
CL-1331	7314150347728	48	542
CL-1441	7314150347735	36	542
CLIPS-1/2	7314153003201	25	95
CLIPS-1/4	7314153003188	25	82
CLIPS-3/8	7314153003195	25	88
CR B 01	7314150215409	60	254
CR B 02	7314150215416	60	254
CR B 03	7314150215423	60	254
CR B 05	7314150215454	2	255
CR B 06	7314150215461	2	255
CR L 01	7314150215911	1	257
CR L 02	7314150215928	1	257
CR L 03	7314150215935	1	257
CR OV 01	7314150489978	1	255
CR SA H01	7314150489992	1	256
CR SA H16	7314150508990	1	256
CR SA S01	7314150490011	1	256
CR SA T01	7314150490035	1	256
CR W 01	7314150215492	1	255
CR W 02	7314150215508	1	255
CR W 03	7314150215515	1	255
CR W 04	7314150215522	1	256
CR W 05	7314150215539	1	256
CR W 06	7314150215546	1	256
CS-SPARE	7314150453030	1	544
CS150	7314150125241	12	544
CS300	7314150125258	12	544
CS400	7314150125265	12	544
D-DD/S20	7311518280345	4	178
D/S10	7311518280307	6	179
D/S14	7311518280314	6	179
D0303I03	7314150501281	5	147
D0303M03	7311518100957	1	144
D0303M03X	7311518182052	1	144
D0605M03X	7311518197896	1	144



D0606106



D0606106	7314150501328	5	147
D0606M06	7311518100988	1	144
D0606M06X	7311518101008	1	144
D0606S06	7314150501359	5	146
D0807M06	7311518043896	1	144
D0807M06X	7311518043919	1	144
D1009M06	7311518035280	1	144
D1009M06X	7311518035297	1	144
D1010I06	7314150501380	5	147
D1010S06	7314150501410	5	146
D1211AL06	7311518187644	1	146
D1211AL08	7311518181840	1	146
D1211M06	7311518035334	1	144
D1211M06X	7311518035358	1	144
D1212I06	7314150501441	5	147
D1212S06	7314150501472	5	146
D1614M06	7311518192327	1	144
D1614M06X	7311518187385	1	144
D1614M08	7311518035389	1	144
D1614M08X	7311518035402	1	144
DD/S10	7311518280321	6	179
DD/S14	7311518280338	4	178
DOW 175-1	7314152202728	266	266
DOW 175-11/2	7314152202995	1	266
DOW 175-2	7314152203022	1	266
DOW 175-3	7314152203299	1	266
DOW 176-1	7314152206047	1	267
DOW 176-11/2	7314152206122	1	267
DOW 176-2	7314152206399	1	267
DOW 177-1/2-1	7314152816383	1	266
DOW 177-11/2	7314152816468	1	266
DOW 177-2	7314152816543	1	266
E0308M03	7311518035433	1	144
E0308M03X	7311518192372	1	144
E0614M06	7311518035464	1	144
E0816M06	7311518035518	1	144
E0816M06X	7311518035532	1	144
E1015I06	7314150501496	5	147
E1018M06	7311518035563	1	144
E1018M06X	7311518035587	1	144
E1220I06	7314150501526	5	147
E1222M06	7311518035617	1	144
E1222M06X	7311518035631	1	144
E1222M08	7311518172558	1	144
E1222M08X	7311518199302	1	144
E1625M06	7311518192440	1	144
E1625M06X	7311518187392	1	144
E1625M08	7311518035709	1	144
E1625M08X	7311518035723	1	144
EX-14-TEN-C	7311518298333	5	563
EX-14-VEN-C	7311518298340	10	563
EX-16-GNP-C	7311518298685	10	560
EX-19-XT9-C	7311518298302	10	562
EX-20-LAM-C	7311518298326	10	563
EX-20-XT11-C	7311518298319	10	563
EX-22-PLS-C	7311518298357	10	560
EX-22-U7	7311518300890	10	562
EX-22-XT7-C	7311518298289	10	564
EX-22-XT9-C	7311518298296	10	562
EX-24-XT7-C	7311518298272	10	564
EX-244P-22	7311518298456	10	564
EX-LL	7311518298494	4	566
EX-NPP-22	7311518324162	10	562
EX-RL	7311518298487	4	566
EX-RM	7311518298470	4	566
F0312I03	7314150501502	5	147
F0313M03	7311518035754	1	144
F0313M03X	7311518192495	1	144
F0613M03X	7311518196608	1	144
F0618AL06	7311518181857	1	146
F0618I06	7314150501533	5	147
F0618M06	7311518035792	1	144
F0618M06X	7311518035815	1	144
F0618S06	7314150501564	5	146
F0820M06	7311518035839	1	144
F0820M06X	7311518035860	1	144
F1020I06	7314150501595	5	147
F1020M06	7311518035891	1	144
F1020M06X	7311518035914	1	144
F1020S06	7314150501625	5	146
F1225AL06	7311518187651	1	146
F1225AL08	7311518181864	1	146
F1225I06	7314150501656	5	147
F1225M06	7311518035945	1	144
F1225M06X	7311518036003	1	144
F1225M08	7311518035983	1	144
F1225M08X	7311518192563	1	144
F1225S06	7314150501687	5	146
F1625M06	7311518192570	1	144
F1625M06X	7311518187408	1	144
F1625M08	7311518036034	1	144
FCP-1.8-810	7311518123970	4	600
FCP-2.3-860	7311518123994	2	600
FCS-1000	7314150321551	6	545
FCS-600	7314150321537	6	545
FCS-800	7314150321544	6	545



FF1A01	7314150228560	1	395
FF1A02	7314150228591	1	395
FF1A03	7314150228607	1	395
FF1A04	7314150227778	1	395
FF1A051	7314150478446	1	395
FF1A06	7314150227822	1	396
FF1A07	7314150227846	1	396
FF1A08	7314150227976	1	396
FF1A09	7314150227990	1	396
FF1A1004	7314150286454	1	396
FF1A1010	7314150320660	1	397
FF1A1011	7314150339068	1	397
FF1A102	7314150334841	1	397
FF1A104	7314150334865	1	397
FF1A106	7314150335541	1	397
FF1A11	7314150228034	1	397
FF1A110	7314150335619	1	398
FF1A112	7314150335572	1	398
FF1A114	7314150335633	1	398
FF1A115	7314150335640	1	398
FF1A117	7314150335701	1	398
FF1A118	7314150335732	1	398
FF1A119	7314150335749	1	399
FF1A12	7314150228058	1	399
FF1A121	7314150335718	1	399
FF1A124	7314150335725	1	399
FF1A127	7314150336395	1	399
FF1A128	7314150336586	1	399
FF1A129	7314150336593	1	400
FF1A13	7314150228072	1	400
FF1A130	7314150336661	1	400
FF1A131	7314150336678	1	400
FF1A132	7314150336685	1	400
FF1A133	7314150336692	1	401
FF1A134	7314150336708	1	401
FF1A135	7314150336715	1	401
FF1A136	7314150336722	1	401
FF1A137	7314150336739	1	401
FF1A138	7314150336746	1	402
FF1A139	7314150336753	1	402
FF1A14	7314150228089	1	402
FF1A141	7314150336777	1	402
FF1A142	7314150338573	1	402
FF1A143	7314150338580	1	402
FF1A145	7314150338603	1	403
FF1A146	7314150338610	1	403
FF1A147	7314150338627	1	403
FF1A15	7314150228096	1	403
FF1A153	7314150350445	1	403
FF1A154	7314150350476	1	404
FF1A16	7314150228102	1	404
FF1A164	7314150350957	1	404
FF1A165	7314150350964	1	404
FF1A167	7314150350988	1	404
FF1A168	7314150350995	1	404
FF1A169	7314150351008	1	405
FF1A170	7314150351800	1	405
FF1A18	7314150228126	1	405
FF1A185	7314150358694	1	405
FF1A189	7314150405961	1	405
FF1A19	7314150254354	1	405
FF1A194	7314150431496	1	406
FF1A195LM	7314150455850	1	389
FF1A196LM	7314150455874	1	390
FF1A197LM	7314150455881	1	390
FF1A198LM	7314150455898	1	390
FF1A199LM	7314150455904	1	390
FF1A20	7314150254361	1	406
FF1A200LM	7314150455928	1	390
FF1A201LM	7314150455935	1	390
FF1A202LM	7314150455966	1	391
FF1A203LM	7314150455973	1	391
FF1A204LM	7314150455980	1	391
FF1A205LM	7314150455997	1	391
FF1A206LM	7314150456000	1	391
FF1A207LM	7314150456017	1	391
FF1A208LM	7314150456024	1	392
FF1A209LM	7314150456031	1	392
FF1A210LM	7314150456062	1	392
FF1A211LM	7314150456079	1	392
FF1A212LM	7314150456086	1	392
FF1A213	7314150437283	1	392
FF1A214LM	7314150456093	1	393
FF1A215LM	7314150456109	1	393
FF1A216LM	7314150456123	1	393
FF1A218LM	7314150456130	1	393
FF1A219LM	7314150456147	1	393
FF1A22	7314150254385	1	406
FF1A220LM	7314150456154	1	394
FF1A221LM	7314150456161	1	394
FF1A222LM	7314150456178	1	394
FF1A223LM	7314150456185	1	394
FF1A224LM	7314150456192	1	394
FF1A225LM	7314150456208	1	394
FF1A23	7314150254392	1	406
FF1A230	7314150461455	1	406

FF1A2301	7314150286508	1	407
FF1A235	7314150500666	1	407
FF1A236	7314150500680	1	407
FF1A24	7314150254408	1	407
FF1A25	7314150254415	1	407
FF1A2501	7314150286492	1	408
FF1A2503	7314150320677	1	408
FF1A26	7314150254422	1	408
FF1A28	7314150254446	1	408
FF1A29NB	7314150266340	1	409
FF1A3001	7314150286515	1	409
FF1A3002	7314150289264	1	409
FF1A3003	7314150286522	1	409
FF1A3004	7314150286676	1	409
FF1A3005	7314150286638	1	409
FF1A30NB	7314150266357	1	409
FF1A31NB	7314150266364	1	410
FF1A35	7314150264124	1	410
FF1A36	7314150265862	1	410
FF1A37	7314150265855	1	410
FF1A39	7314150266920	1	410
FF1A4001	7314150286713	1	410
FF1A4002	7314150286560	1	411
FF1A4003	7314150286706	1	411
FF1A41	7314150266982	1	411
FF1A48	7314150271801	1	411
FF1A50	7314150271825	1	411
FF1A5002	7314150286447	1	411
FF1A5003	7314150286690	1	412
FF1A5004	7314150286539	1	412
FF1A5005	7314150286546	1	412
FF1A5006	7314150286683	1	412
FF1A5007	7314150286553	1	413
FF1A5008	7314150286607	1	413
FF1A5009	7314150286669	1	413
FF1A5010	7314150286584	1	413
FF1A5011	7314150286614	1	413
FF1A5012	7314150286652	1	414
FF1A5013	7314150286577	1	414
FF1A5015	7314150307401	1	414
FF1A5017	7314150307425	1	414
FF1A5019	7314150309436	1	414
FF1A5021	7314150309467	1	414
FF1A5022	7314150309474	1	415
FF1A5023	7314150309498	1	415
FF1A5024	7314150309504	1	415
FF1A5027	7314150320684	1	415
FF1A5028	7314150320691	1	415
FF1A5029	7314150320707	1	416
FF1A5030	7314150320714	1	416
FF1A5031	7314150320721	1	416
FF1A5032	7314150320738	1	416
FF1A5036	7314150339037	1	416
FF1A5037	7314150339044	1	416
FF1A5038	7314150339051	1	417
FF1A51	7314150271832	1	417
FF1A53	7314150271856	1	417
FF1A54	7314150288786	1	417
FF1A55	7314150299720	1	417
FF1A56	7314150299737	1	417
FF1A65	7314150313389	1	418
FF1A66	7314150313396	1	418
FF1A67	7314150313402	1	418
FF1A68	7314150313419	1	418
FF1A70	7314150320189	1	418
FF1A71	7314150320196	1	418
FF1A72	7314150320202	1	419
FF1A82	7314150334070	1	419
FF1ASET-AUTO	7314150437993	1	387
FF1ASET-AUTO-M1	7314150438259	1	388
FF1ASET-AUTO-M2	7314150438327	1	388
FF1ASET-AUTO-M3	7314150438334	1	388
FF1ASET-AUTO-M4	7314150438341	1	389
FF1ASET-AUTO-M5	7314150438358	1	389
FF1ASET-AUTO-M6	7314150438365	1	389
FF1ASET-AUTO1	7314150254453	1	387
FF1ASET-AUTO2	7314150254460	1	388
FF1ASET-AUTO3	7314150254477	1	388
FF1ASET-AUTO6	7314150319909	1	388
FF1ASET-BASIC	7314150437368	1	387
FF1ASET-LARGE	7314150437108	1	386
FF1ASET-MRO2	7314150336623	1	387
FF1ASET-MRO3	7314150336630	1	387
FF1ASET-MRO4	7314150336647	1	387
FF1ASET-MRO5	7314150336654	1	387
FF1ASET-XLARGE	7314150436965	1	386
FF1B01LM	7314150455416	1	384
FF1B02LM	7314150455447	1	384
FF1B03LM	7314150455454	1	385
FF1B04LM	7314150455478	1	385
FF1B05LM	7314150455515	1	385
FF1B06LM	7314150455522	1	385
FF1B07LM	7314150455614	1	385
FF1B08LM	7314150455645	1	386
FF1B09LM	7314150455669	1	386
FF1B10LM	7314150455706	1	386

FF1B11LM	7314150455713	1	386
FF1BSET-MONSTER	7314150436835	1	384
FF1E1001	7314150285839	1	425
FF1E1002	7314150285761	1	425
FF1E1003	7314150285853	1	425
FF1E1004	7314150285754	1	425
FF1E1005	7314150285785	1	426
FF1E1006	7314150285778	1	426
FF1E1007	7314150285792	1	426
FF1E1008	7314150285822	1	426
FF1E1009	7314150285808	1	426
FF1E1009EH	7314150352579	1	433
FF1E1010	7314150285815	1	426
FF1E1011	7314150285846	1	426
FF1E1012EH	7314150352562	1	433
FF1E1013EH	7314150352586	1	433
FF1E2001	7314150285945	1	426
FF1E2002	7314150285921	1	427
FF1E2003	7314150286072	1	427
FF1E2004	7314150285952	1	427
FF1E2005	7314150285976	1	427
FF1E2006	7314150285914	1	427
FF1E2007	7314150285907	1	427
FF1E2008	7314150285860	1	428
FF1E2009EH	7314150352593	1	434
FF1E2010EH	7314150352654	1	434
FF1E2011EH	7314150373802	1	435
FF1E2101	7314150285877	1	428
FF1E2102	7314150286058	1	428
FF1E2103	7314150286089	1	428
FF1E2104	7314150285990	1	428
FF1E2105	7314150286041	1	428
FF1E2106EH	7314150352623	1	434
FF1E2107EH	7314150352661	1	434
FF1E2201	7314150286010	1	429
FF1E2202	7314150285891	1	429
FF1E2203	7314150285884	1	429
FF1E2204	7314150285983	1	429
FF1E2205	7314150285938	1	429
FF1E2206	7314150286034	1	429
FF1E2207	7314150285969	1	430
FF1E2208	7314150286027	1	430
FF1E2209	7314150286096	1	430
FF1E2210	7314150286065	1	430
FF1E2211	7314150339006	1	430
FF1E2212	7314150339013	1	430
FF1E2213	7314150339020	1	431
FF1E2214EH	7314150352647	1	434
FF1E2215EH	7314150352678	1	434
FF1E2216EH	7314150373833	1	436
FF1E2501	7314150286003	1	431
FF1E2502	7314150338993	1	431
FF1E2503EH	7314150352685	1	434
FF1E2504EH	7314150374106	1	436
FF1E2505EH	7314150373826	1	436
FF1E3001	7314150286119	1	431
FF1E3002	7314150286102	1	431
FF1E3003	7314150286157	1	432
FF1E3004	7314150286133	1	432
FF1E3005	7314150286126	1	432
FF1E3006	7314150286140	1	432
FF1E3007	7314150286164	1	432
FF1E3008	7314150286171	1	432
FF1E3009EH	7314150352722	1	434
FF1E3010EH	7314150352739	1	435
FF1E3011EH	7314150352753	1	435
FF1E4001	7314150285747	1	432
FF1E4002	7314150285730	1	432
FF1E4003EH	7314150352692	1	435
FF1E4004EH	7314150352708	1	435
FF1E4005EH	7314150352807	1	433
FF1E5001	7314150285716	1	433
FF1E5002	7314150285709	1	433
FF1E5003	7314150285723	1	433
FF1E5004	7314150338931	1	433
FF1E5005	7314150338948	1	431
FF1E5006	7314150338955	1	431
FF1E5007	7314150338962	1	432
FF1E5008	7314150338979	1	432
FF1E5009	7314150338986	1	431
FF1E5010EH	7314150352746	1	435
FF1E5011EH	7314150352777	1	435
FF1E5013EH	7314150352821	1	435
FF1E5014EH	7314150373864	1	436
FF1E5015EH	7314150373871	1	436
FF1E5016EH	7314150373888	1	436
FF1F1001	7314150286270	1	419
FF1F1002	7314150286287	1	419
FF1F1003	7314150286294	1	419
FF1F1004	7314150286263	1	419
FF1F1005	7314150286300	1	419
FF1F1006	7314150286249	1	420
FF1F1007	7314150286256	1	420
FF1F1008	7314150339129	1	420
FF1F1009	7314150339136	1	420
FF1F2001	7314150286317	1	420





FF1F2002	7314150339143	1	420
FF1F2101	7314150286331	1	420
FF1F2102	7314150339105	1	421
FF1F2103	7314150339112	1	421
FF1F2201	7314150286324	1	421
FF1F2202	7314150339150	1	421
FF1F2203	7314150339167	1	421
FF1F3001	7314150286348	1	421
FF1F3002	7314150286379	1	422
FF1F3003	7314150286409	1	422
FF1F3004	7314150286386	1	422
FF1F3005	7314150286362	1	422
FF1F3006	7314150286355	1	422
FF1F3007	7314150286393	1	422
FF1F3008	7314150286423	1	422
FF1F3009	7314150286416	1	422
FF1F3010	7314150339082	1	423
FF1F3011	7314150339099	1	423
FF1F4001	7314150286195	1	423
FF1F4002	7314150286201	1	423
FF1F4003	7314150286225	1	423
FF1F4004	7314150286232	1	423
FF1F4005	7314150286218	1	423
FF1F5001	7314150286188	1	424
FF1F5002	7314150339174	1	424
FF1F5003	7314150339181	1	424
FF1F5004	7314150339198	1	421
FF1F5005	7314150339204	1	424
FF1F5006	7314150339211	1	424
FF1F5007	7314150339228	1	424
FF1F5008	7314150339235	1	424
FF1F5009	7314150339242	1	425
FF1F5010	7314150339259	1	425
FF1F5011	7314150339266	1	425
FF1F5012	7314150339273	1	425
FF1F5013	7314150339280	1	421
FF2A07	7314150228201	1	444
FF2A08	7314150228225	1	444
FF2A09	7314150228249	1	445
FF2A10	7314150228263	1	445
FF2B01	7314150233441	1	445
FF2B02	7314150233465	1	445
FF2B03	7314150233489	1	445
FF2B04	7314150233502	1	446
FF2B05	7314150233526	1	446
FF2B06	7314150233540	1	446
FF2B07	7314150229420	1	446
FF2B08	7314150229451	1	446
FF2B09	7314150229482	1	446
FF2B10	7314150229505	1	447
FF2B11	7314150229529	1	447
FF2B12	7314150229543	1	447
FF2B13	7314150229567	1	447
FF2B14	7314150229581	1	447
FF2B15	7314150229604	1	448
FF2B16	7314150229628	1	448
FF3A01	7314150228300	1	458
FF3A02	7314150228324	1	459
FF3A03	7314150228348	1	459
FF3A04	7314150228362	1	459
FF3A05	7314150228386	1	459
FF3A06	7314150228416	1	459
FF3A07	7314150228430	1	460
FF3A08	7314150228454	1	460
FF3A09	7314150228478	1	460
FF3A10	7314150228492	1	460
FF3A11	7314150228515	1	448
FF3A12	7314150228539	1	449
FF3A13	7314150228614	1	449
FF3A14	7314150228638	1	449
FF3A15	7314150228652	1	449
FF3A16	7314150228676	1	449
FF3A17	7314150228690	1	450
FFSS-1.5-900FG	7311518275884	4	600
FGS-1.0-600	7311518123796	4	600
FGS-1.25-700	7311518123802	4	600
FGS-1.25-700-WB	7314150398720	4	600
FGS-1.6-810	7311518123819	4	600
FGS-1.6-810-WB	7314150399086	4	600
FGS-1.8-810	7311518123826	4	600
FM10	7311518010881	5	31
FM12	7314150273249	5	31
FP-3M	7311518168612	1	626
FS-5	7311518266455	10	632
FS-7.5	7311518266479	10	633
FS-8	7311518266462	10	632
G0313M03	7311518036089	1	144
G0313M03X	7311518182069	1	144
G0613M03X	7311518196592	1	144
G0618M06	7311518036119	1	144
G0618M06X	7311518036133	1	144
G0820M06	7311518036164	1	144
G0820M06X	7311518036188	1	144
G1020I06	7314150501519	5	147
G1020M06	7311518036218	1	144
G1020M06X	7311518036232	1	144



G1020S06	7314150501540	5	146
G1225I06	7314150501571	5	147
G1225M06	7311518036317	1	144
G1225M06X	7311518036331	1	144
G1225M08	7311518036362	1	144
G1225M08X	7311518188009	1	144
G1225S06	7314150501601	5	146
G1625M06	7311518192648	1	144
G1625M06X	7311518187415	1	144
G1625M08	7311518036409	1	144
G1625M08X	7311518036423	1	144
GL008-10	7314150167050	5	490
GL008-8	7314150167043	5	490
GL010-10	7314150167098	5	490
GL010-8	7314150167081	5	490
GS-180-F	7311518275488	6	632
GS-76	7311518010782	8	631
H0613M03X	7311518196615	1	145
H1020I06	7314150501717	5	147
H1025M06	7311518182304	1	145
H1025M06X	7311518182311	1	145
H1232I06	7314150501748	5	147
H1232M06	7311518182076	1	145
H1232M06X	7311518181758	1	145
H1635M06	7311518192730	1	145
H1635M06X	7311518187422	1	145
H1635M08	7311518182083	1	145
H1635M08X	7311518182090	1	145
HFGPS-0.7-400FG	7311518275877	4	600
HGPS-0.6-360	7311518123680	10	600
HGPS-0.8-380	7311518123697	4	600
HGPS-0.8-380-WB	7314150398812	4	600
HGPS-1.0-400	7311518123703	4	600
HGPS-1.0-400-WB	7314150398713	4	600
HRFM10	7311518010898	5	31
HS 7590	7314150109395	1	650
HS 7890	7314150109401	1	651
HS 7891	7314150109425	10	651
HS 7892	7314150109432	1	651
HS 7893	7314150109456	1	652
HS 8130	7314150107773	1	644
HS 8131	7314150107803	1	644
HS 8132	7314150107810	1	644
HS 8140	7314150107926	10	644
HS 8141	7314150107940	10	644
HS 8142	7314150107964	10	644
HS 8143	7314150107988	10	645
HS 8144	7314150108008	10	645
HS 8145	7314150108022	10	645
HS 8148	7314150108084	10	645
HS 8150	7314150108114	1	644
HS 8160	7314150108305	10	644
HS 8161	7314150108329	10	644
HS 8162	7314150108343	10	644
HS 8163	7314150108367	10	645
HS 8164	7314150402144	10	645
HS 8247	7314150108480	1	647
HS 8248	7314150108503	10	647
HS122M.030	7314150423293	5	653
HS6000	7314150113781	10	648
HS6001	7314150476466	10	648
HS7190	7314150475988	1	645
HS7191	7314150476473	1	645
HS7280	7314150476480	1	647
HS7285	7314150476497	1	647
HS7290	7314150476503	1	646
HS7291	7314150476510	1	646
HS7292	7314150383719	10	646
HS7293	7314150476527	1	646
HS7490	7314150350674	10	650
HS7894	7314150476534	1	652
HS8133	7314150476541	1	645
HS8134	7314150476555	1	645
HS8135	7314150476572	1	645
HS8136	7314150476589	1	645
HS8137	7314150476596	1	645
HS8138	7314150476602	1	645
HS8146	7314150425372	10	645
HS8147	7314150351954	10	645
HS8149	7314150476619	1	648
HS8151	7314150349388	10	644
HS8152	7314150476626	10	644
HS8153	7314150360055	10	645
HS8154	7314150349418	10	645
HS8155	7314150476633	1	645
HS8156	7314150476640	1	645
HS8157	7314150476657	1	645
HS8158	7314150476664	1	645
HS8165	7314150374526	10	645
HS8166	7314150476671	1	645
HS8167	7314150476688	1	645
HS8168	7314150476695	1	645
HS8211	7314150365067	10	646
HUS-0.6-380	7311518123659	4	600
HUS-0.8-500	7311518123666	4	600
HUS-1.0-650	7311518123673	4	600



IZO-D-135	7314151845827	1	105
IZO-D-200	7314151846831	1	105
IZO-D-30	7314151846824	1	105
IZO-D-340	7314151846848	1	105
IZO-DR-810	7314151846817	1	105
J0604M06	7311518036508	1	145
J1010M06	7311518172473	1	145
J1212M06	7311518036577	1	145
J1616M06	7311518187439	1	145
J1616M08	7311518036614	1	145
K-AP-1	7311518030117	10	632
K-GP-1	7311518030131	10	632
K0602M06	7311518036652	1	145
K1008M06	7311518036683	1	145
K1210M06	7311518036720	1	145
K1612M06	7311518193959	1	145
K1612M08	7311518036768	1	145
K172	7314150384396	1	173
K18NF-2	7314151347161	1	170
K18PH-2M5	7314153019646	1	170
K18PH-2M6	7314150274871	1	170
K19PZD-2M5	7314151693237	1	170
K19PZD-2NF	7314151586157	1	170
K20TORX-T25	7314151825799	1	170
K560F-1	7314151825492	5	173
K560F-2	7314151825324	5	174
K560F-3	7314151825331	5	174
K560F-4	7314151825348	5	178
K560F-5	7314151825355	5	178
K560F-6	7314151825362	5	181
K560F-7	7314151825379	5	183
K560F-8	7314151825508	5	183
K560F-9	7314151846688	5	185
K66100-1/4	7314150204540	1	172
K66100-1/4-1P	7314150260201	1	172
K66100-3/8	7314150204564	1	172
K66100-3/8-1P	7314150260249	1	172
K6625-1/4-1P	7314150260140	1	172
K6625-1/4B-5P	7314150533305	1	172
K6638-3/8	7314150204557	1	172
K6638-3/8-1P	7314150260164	1	172
K6650-1/2-1P	7314150260188	1	172
K6650-1/2P-5P	7314150533367	1	172
K6650-1/4B-1P	7314150533381	1	172
K6650-1/4P-5P	7314150533404	1	172
K6650-3/8-1P	7314150260225	1	172
K6650-3/8P-5P	7314150533442	1	172
K6660-QR-1P	7314150204571	1	172
K6701M-10	7314151778149	1	172
K6701M-11	7314151778224	1	172
K6701M-12	7314151811891	1	172
K6701M-13	7314151778491	1	172
K6701M-14	7314151844172	1	172
K6701M-6	7314151813260	1	172
K6701M-7	7314151777920	1	172
K6701M-8	7314151778064	1	172
K6701M-9	7314151815110	1	172
K6750-1/4	7314150204663	1	170
K6750-10-1P	7314150533466	1	170
K6750-13	7314150204823	1	170
K6750-3/8	7314150204656	1	170
K6750-6	7314150204670	1	170
K6750-7	7314150204687	1	170
K6964C	7314151215170	1	174
K7401M-10	7314151780128	1	173
K7401M-11	7314151780395	1	173
K7401M-12	7314151811907	1	173
K7401M-13	7314151780470	1	173
K7401M-14	7314151780555	1	173
K7401M-15	7314151812140	1	173
K7401M-16	7314151780630	1	173
K7401M-17	7314151780715	1	173
K7401M-18	7314151812157	1	173
K7401M-19	7314151812164	1	173
K7401M-20	7314151844271	1	173
K7401M-21	7314151845216	1	173
K7401M-22	7314151845223	1	173
K7401M-24	7314151844295	1	173
K7401M-7	7314151812126	1	173
K7401M-8	7314151780043	1	173
K7401M-9	7314151812133	1	173
K7401M/10	7314150389919	1	174
K7401TORX-E-S7	7314150343324	1	175
K7401TORX-E10	7314151844448	1	174
K7401TORX-E12	7314151844455	1	174
K7401TORX-E14	7314151844462	1	174
K7401TORX-E5	7314151844400	1	174
K7401TORX-E6	7314151844417	1	174
K7401TORX-E7	7314151844424	1	174
K7401TORX-E8	7314151844431	1	174
K7401Z-1/2	7314150384402	1	173
K7401Z-11/16	7314150384419	1	173
K7401Z-13/16	7314150384426	1	173
K7401Z-3/4	7314150384433	1	173
K7401Z-3/8	7314150384440	1	173
K7401Z-5/8	7314150384457	1	173



K7401Z-7/16	7314150384464	1	173
K7401Z-7/8	7314150384471	1	173
K7401Z-9/16	7314150384488	1	173
K7406M-10	7314151844479	1	173
K7406M-13	7314151844486	1	173
K7406M-17	7314151844493	1	173
K7760C-1	7314151222369	1	174
K7760C-2	7314151222376	1	174
K7764D	7314151222475	1	177
K7767S	7314151222512	1	174
K7800M-10	7314150326297	1	175
K7800M-11	7314150326303	1	175
K7800M-12	7314150326310	1	175
K7800M-13	7314150326327	1	175
K7800M-14	7314150326334	1	175
K7800M-15	7314150326341	1	175
K7800M-16	7314150326358	1	175
K7800M-17	7314150326365	1	175
K7800M-18	7314150326372	1	175
K7800M-19	7314150326389	1	175
K7800M-21	7314150326396	1	175
K7800M-22	7314150326402	1	175
K7800M-24	7314150326419	1	175
K7800M/13	7314150437221	1	178
K7801M-10	7314151778576	1	175
K7801M-11	7314151778651	1	175
K7801M-12	7314151815790	1	175
K7801M-13	7314151778736	1	175
K7801M-14	7314151778811	1	175
K7801M-15	7314151815806	1	175
K7801M-16	7314151779030	1	175
K7801M-17	7314151779115	1	175
K7801M-18	7314151779382	1	175
K7801M-19	7314151779467	1	175
K7801M-20	7314151844509	1	175
K7801M-21	7314151779542	1	175
K7801M-22	7314151779627	1	175
K7801M-23	7314151844516	1	175
K7801M-24	7314151779894	1	175
K7801M-25	7314151844523	1	175
K7801M-26	7314151844530	1	175
K7801M-27	7314151779979	1	175
K7801M-28	7314150430154	1	175
K7801M-29	7314150430161	1	175
K7801M-30	7314151811914	1	175
K7801M-32	7314151825157	15	175
K7801M-34	7314151844547	1	175
K7801M-36	7314151844554	1	175
K7801M-8	7314151845230	1	175
K7801M-9	7314151845247	1	175
K7801TORX-E10	7314151811587	1	177
K7801TORX-E12	7314151811594	1	177
K7801TORX-E14	7314151811600	1	177
K7801TORX-E16	7314151811617	1	177
K7801TORX-E18	7314151811624	1	177
K7801TORX-E20	7314151811631	1	177
K7801TORX-E24	7314151811648	1	177
K7801VM-17	7314151781521	1	176
K7801VM-19	7314151781798	1	176
K7801VM-22	7314151781873	1	176
K7801VM-24	7314151781958	1	176
K7801VM/S4	7314151799090	1	178
K7801Z-1	7314151844639	1	176
K7801Z-1.1/16	7314151844646	1	176
K7801Z-1.1/2	7314150137701	5	176
K7801Z-1.1/4	7314151844660	1	176
K7801Z-1.1/8	7314151844653	1	176
K7801Z-1.3/8	7314150137688	5	176
K7801Z-1.5/16	7314150137671	5	176
K7801Z-1.7/16	7314150137695	5	176
K7801Z-1/2	7314151822620	1	176
K7801Z-11/16	7314151844592	1	176
K7801Z-13/16	7314151844608	1	176
K7801Z-15/16	7314151844622	1	176
K7801Z-3/4	7314151822668	1	176
K7801Z-3/8	7314151822606	1	176
K7801Z-5/8	7314151844585	1	176
K7801Z-7/16	7314151844561	1	176
K7801Z-7/8	7314151844615	1	176
K7801Z-9/16	7314151822637	1	176
K7801Z/10	7314150165018	1	178
K7806M-10	7314151844677	1	175
K7806M-11	7314151844684	1	175
K7806M-12	7314151844691	1	175
K7806M-13	7314151805944	1	175
K7806M-14	7314151844707	1	175
K7806M-15	7314150330683	1	175
K7806M-16	7314151844714	1	175
K7806M-17	7314151805951	1	175
K7806M-18	7314151844721	1	175
K7806M-19	7314151805968	1	175
K7806M-21	7314151823597	1	175
K7806M-22	7314151805975	1	175
K7806M-23	7314151844738	1	175
K7806M-24	7314151805982	1	175
K7806M-27	7314151805999	1	175



K7806M-30



K7806M-30	7314151844578	1	175
K7806M-32	7314150220304	1	175
K7806M-36	7314150220311	1	175
K7806M/S4	7314151813222	1	178
K7806Z-1	7314150137817	5	176
K7806Z-1.1/16	7314150137824	5	176
K7806Z-1.1/2	7314150137886	5	176
K7806Z-1.1/4	7314150137848	5	176
K7806Z-1.1/8	7314150137831	5	176
K7806Z-1.3/8	7314150137862	5	176
K7806Z-1.5/16	7314150137855	5	176
K7806Z-1.7/16	7314150137879	5	176
K7806Z-1/2	7314150137749	10	176
K7806Z-11/16	7314150137770	5	176
K7806Z-13/16	7314150137794	5	176
K7806Z-15/16	7314150137718	5	176
K7806Z-3/4	7314150137787	5	176
K7806Z-3/8	7314150137725	10	176
K7806Z-5/8	7314150137763	5	176
K7806Z-7/16	7314150137732	5	176
K7806Z-7/8	7314150137800	5	176
K7806Z-9/16	7314150137756	10	176
K7806Z/10	7314150165025	1	177
K8160D-1	7314151237400	1	177
K8160D-2	7314151237417	1	177
K8160D-3	7314151237424	1	177
K8164C	7314151237523	1	174
K8164F	7314151237554	1	180
K8167S	7314151237592	1	177
K8901M-17	7314151803155	1	179
K8901M-18	7314151844189	1	179
K8901M-19	7314151803162	1	179
K8901M-21	7314151803179	1	179
K8901M-22	7314151803186	1	179
K8901M-23	7314151803193	1	179
K8901M-24	7314151803209	1	179
K8901M-27	7314151803216	1	179
K8901M-28	7314151803223	1	179
K8901M-29	7314151803230	1	179
K8901M-30	7314151803247	1	179
K8901M-32	7314151803254	1	179
K8901M-33	7314151803261	1	179
K8901M-34	7314151803278	1	179
K8901M-36	7314151803285	1	179
K8901M-38	7314151803292	1	179
K8901M-41	7314151803308	1	179
K8901M-46	7314151803315	1	179
K8901M-50	7314151846398	1	179
K8901M-55	7314151846404	1	179
K8901M-60	7314151846411	1	179
K8901M/8	7314150165032	1	181
K8901Z-1	7314151844752	1	180
K8901Z-1.1/16	7314151844769	1	180
K8901Z-1.1/2	7314151844820	1	180
K8901Z-1.1/4	7314151844783	1	180
K8901Z-1.1/8	7314151844776	1	180
K8901Z-1.11/16	7314150130269	1	180
K8901Z-1.13/16	7314150130276	1	180
K8901Z-1.15/16	7314150130290	1	180
K8901Z-1.3/16	7314150130245	1	180
K8901Z-1.3/4	7314151844844	1	180
K8901Z-1.3/8	7314151844806	1	180
K8901Z-1.5/16	7314151844790	1	180
K8901Z-1.5/8	7314151844837	1	180
K8901Z-1.7/16	7314151844813	1	180
K8901Z-1.7/8	7314150130283	1	180
K8901Z-1.9/16	7314150130252	1	180
K8901Z-11/16	7314150130238	1	180
K8901Z-13/16	7314151844226	1	180
K8901Z-15/16	7314151844745	1	180
K8901Z-2	7314150130306	1	180
K8901Z-2.1/16	7314150130313	1	180
K8901Z-2.1/4	7314150130344	1	180
K8901Z-2.3/16	7314150130337	1	180
K8901Z-2.3/8	7314150130351	1	180
K8901Z-3/4	7314151844202	1	180
K8901Z-7/8	7314151844301	1	180
K8901Z/18	7314150436514	1	181
K8901Z/8	7314150165049	1	181
K8906M-17	7314151803056	1	179
K8906M-19	7314151803063	1	179
K8906M-21	7314151844851	1	179
K8906M-22	7314151803070	1	179
K8906M-24	7314151803087	1	179
K8906M-27	7314151803094	1	179
K8906M-30	7314151803117	1	179
K8906M-32	7314151803124	1	179
K8906M-33	7314151844868	1	179
K8906M-34	7314151844875	1	179
K8906M-36	7314151803148	1	179
K8906M-41	7314151845254	1	179
K8906M-42	7314150512607	1	179
K8906M-46	7314150220601	1	179
K8906M/8	7314150165056	1	181
K8906Z-1	7314150130436	1	180
K8906Z-1.1/16	7314150130443	1	180



K8906Z-1.1/2	7314150130511	1	180
K8906Z-1.1/4	7314150130474	1	180
K8906Z-1.1/8	7314150130450	1	180
K8906Z-1.3/4	7314150130559	1	180
K8906Z-1.3/8	7314150130498	1	180
K8906Z-1.5/16	7314150130481	1	180
K8906Z-1.5/8	7314150130535	1	180
K8906Z-1.7/16	7314150130504	1	180
K8906Z-13/16	7314150130405	1	180
K8906Z-15/16	7314150130429	1	180
K8906Z-2	7314150130580	1	180
K8906Z-3/4	7314150130399	1	180
K8906Z-7/8	7314150130412	1	180
K8906Z/8	7314150165063	1	181
K8909H-5	7314151619343	1	180
K8909ML-12	7314151232863	1	183
K8909ML-14	7314151232870	1	183
K8909ML-17	7314151232887	1	183
K8960F-2	7314151268138	1	181
K8960F-3	7314151268145	1	181
K8960F-4	7314150220625	1	181
K8964D	7314151268237	1	177
K8964G	7314151268268	1	182
K8967S	7314151268329	1	180
K9501M-22	7314151844882	1	182
K9501M-24	7314151802677	1	182
K9501M-27	7314151802684	1	182
K9501M-30	7314151802714	1	182
K9501M-32	7314151802721	1	182
K9501M-33	7314151802738	1	182
K9501M-34	7314151802745	1	182
K9501M-36	7314151802752	1	182
K9501M-38	7314151802769	1	182
K9501M-41	7314151802776	1	182
K9501M-42	7314151802783	1	182
K9501M-46	7314151802790	1	182
K9501M-50	7314151802806	1	182
K9501M-55	7314151802813	1	182
K9501M-60	7314151802820	1	182
K9501M-65	7314151802837	1	182
K9501M-70	7314151802844	1	182
K9501M-75	7314151802851	1	182
K9501M-80	7314151802868	1	182
K9501M-85	7314150352197	1	182
K9501Z-1	7314151844912	1	182
K9501Z-1.1/16	7314150130634	1	182
K9501Z-1.1/2	7314151844943	1	182
K9501Z-1.1/4	7314151844929	1	182
K9501Z-1.1/8	7314150130641	1	182
K9501Z-1.11/16	7314150130696	1	182
K9501Z-1.13/16	7314151844967	1	182
K9501Z-1.15/16	7314150130719	1	182
K9501Z-1.3/16	7314150130658	1	182
K9501Z-1.3/4	7314150130702	1	182
K9501Z-1.3/8	7314150130672	1	182
K9501Z-1.5/16	7314150130665	1	182
K9501Z-1.5/8	7314151844950	1	182
K9501Z-1.7/16	7314151844936	1	182
K9501Z-1.7/8	7314151844974	1	182
K9501Z-1.9/16	7314150130689	1	182
K9501Z-2	7314150130726	1	182
K9501Z-2.1/4	7314150130764	1	182
K9501Z-2.1/8	7314150130740	1	182
K9501Z-2.3/16	7314150130757	1	182
K9501Z-2.3/4	7314150130832	1	182
K9501Z-2.5/16	7314150130771	1	182
K9501Z-2.9/16	7314150130801	1	182
K9506M-22	7314151844998	1	182
K9506M-24	7314151802530	1	182
K9506M-27	7314151802547	1	182
K9506M-30	7314151802554	1	182
K9506M-32	7314151802561	1	182
K9506M-33	7314151802578	1	182
K9506M-34	7314151845018	1	182
K9506M-36	7314151802585	1	182
K9506M-38	7314151802592	1	182
K9506M-41	7314151802608	1	182
K9506M-46	7314151802615	1	182
K9506M-50	7314151802622	1	182
K9506M-55	7314151802639	1	182
K9506M-60	7314151802646	1	182
K9506Z-1	7314150131686	1	182
K9506Z-1.1/16	7314150131693	1	182
K9506Z-1.1/2	7314150131761	1	182
K9506Z-1.1/4	7314150131723	1	182
K9506Z-1.13/16	7314150131808	1	182
K9506Z-1.3/16	7314150131716	1	182
K9506Z-1.5/8	7314150131785	1	182
K9506Z-1.7/16	7314150131754	1	182
K9506Z-1.7/8	7314150131815	1	182
K9509H5	7314151619428	1	182
K9509ML-19	7314151618964	1	183
K9509ML-22	7314151619183	1	183
K9509ML-24	7314151619268	1	183
K9560G-0	7314150240012	1	183
K9560G-1	7314151285944	1	183



K9560G-2	7314151285951	1	183
K9560G-3	7314151285968	1	183
K9560G-4	7314150133970	1	183
K9560G-5	7314150133987	1	183
K9564F	7314151286026	1	180
K9567S	7314151286095	1	183
K9598H	7314150133956	1	184
K9801M-100	7314151845162	1	183
K9801M-105	7314151845179	1	183
K9801M-110	7314151845186	1	183
K9801M-115	7314151845193	1	183
K9801M-120	7314151845209	1	183
K9801M-125	7314150167159	1	183
K9801M-130	7314150167166	1	183
K9801M-135	7314150167173	1	183
K9801M-140	7314150167180	1	183
K9801M-145	7314150167197	1	183
K9801M-150	7314150167203	1	183
K9801M-155	7314150167210	1	183
K9801M-46	7314151845056	1	183
K9801M-50	7314151845063	1	183
K9801M-55	7314151845070	1	183
K9801M-60	7314151845087	1	183
K9801M-65	7314151845094	1	183
K9801M-70	7314151845100	1	183
K9801M-75	7314151845117	1	183
K9801M-80	7314151845124	1	183
K9801M-85	7314151845131	1	183
K9801M-90	7314151845148	1	183
K9801M-95	7314151845155	1	183
K9801Z-1.1/2	7314150131976	1	184
K9801Z-1.11/16	7314150132003	1	184
K9801Z-1.13/16	7314150132027	1	184
K9801Z-1.15/16	7314150132041	1	184
K9801Z-1.3/4	7314150132010	1	184
K9801Z-1.3/8	7314150131952	1	184
K9801Z-1.5/8	7314150131990	1	184
K9801Z-1.7/16	7314150131969	1	184
K9801Z-1.7/8	7314150132034	1	184
K9801Z-1.9/16	7314150131983	1	184
K9801Z-2	7314150132058	1	184
K9801Z-2.1/16	7314150132065	1	184
K9801Z-2.1/2	7314150132133	1	184
K9801Z-2.1/4	7314150132096	1	184
K9801Z-2.1/8	7314150132072	1	184
K9801Z-2.11/16	7314150132164	1	184
K9801Z-2.13/16	7314150132188	1	184
K9801Z-2.15/16	7314150132201	1	184
K9801Z-2.3/16	7314150132089	1	184
K9801Z-2.3/4	7314150132171	1	184
K9801Z-2.3/8	7314150132119	1	184
K9801Z-2.5/16	7314150132102	1	184
K9801Z-2.5/8	7314150132157	1	184
K9801Z-2.7/16	7314150132126	1	184
K9801Z-2.7/8	7314150132195	1	184
K9801Z-2.9/16	7314150132140	1	184
K9801Z-3	7314150132218	1	184
K9801Z-3.1/16	7314150132225	1	184
K9801Z-3.1/2	7314150132287	1	184
K9801Z-3.1/4	7314150132249	1	184
K9801Z-3.1/8	7314150132232	1	184
K9801Z-3.11/16	7314150132317	1	184
K9801Z-3.13/16	7314150132331	1	184
K9801Z-3.15/16	7314150132355	1	184
K9801Z-3.3/4	7314150132324	1	184
K9801Z-3.3/8	7314150132263	1	184
K9801Z-3.5/16	7314150132256	1	184
K9801Z-3.5/8	7314150132300	1	184
K9801Z-3.7/16	7314150132270	1	184
K9801Z-3.7/8	7314150132348	1	184
K9801Z-3.9/16	7314150132294	1	184
K9801Z-4	7314150132362	1	184
K9801Z-4.1/16	7314150132379	1	184
K9801Z-4.1/2	7314150132430	1	184
K9801Z-4.1/4	7314150132393	1	184
K9801Z-4.1/8	7314150132386	1	184
K9801Z-4.3/4	7314150132454	1	184
K9801Z-4.3/8	7314150132416	1	184
K9801Z-4.5/16	7314150132409	1	184
K9801Z-4.5/8	7314150132447	1	184
K9801Z-4.7/16	7314150132423	1	184
K9806M-100	7314150131105	1	183
K9806M-105	7314150131112	1	183
K9806M-110	7314150131129	1	183
K9806M-115	7314150131136	1	183
K9806M-120	7314150131143	1	183
K9806M-41	7314150130986	1	183
K9806M-46	7314150130993	1	183
K9806M-50	7314150131006	1	183
K9806M-55	7314150131013	1	183
K9806M-60	7314150131020	1	183
K9806M-65	7314150131037	1	183
K9806M-70	7314150131044	1	183
K9806M-75	7314150131051	1	183
K9806M-80	7314150131068	1	183
K9806M-85	7314150131075	1	183



K9806M-90	7314150131082	1	183
K9806M-95	7314150131099	1	183
K9806Z-1.1/2	7314150131174	1	184
K9806Z-1.11/16	7314150131198	1	184
K9806Z-1.3/8	7314150131150	1	184
K9806Z-1.5/8	7314150131181	1	184
K9806Z-1.7/16	7314150131167	1	184
K9806Z-2	7314150131204	1	184
K9806Z-2.1/16	7314150131211	1	184
K9806Z-2.1/2	7314150131273	1	184
K9806Z-2.1/4	7314150131235	1	184
K9806Z-2.11/16	7314150131303	1	184
K9806Z-2.13/16	7314150131327	1	184
K9806Z-2.15/16	7314150131341	1	184
K9806Z-2.3/16	7314150131228	1	184
K9806Z-2.3/4	7314150131310	1	184
K9806Z-2.3/8	7314150131259	1	184
K9806Z-2.5/16	7314150131242	1	184
K9806Z-2.5/8	7314150131297	1	184
K9806Z-2.7/16	7314150131266	1	184
K9806Z-2.7/8	7314150131334	1	184
K9806Z-2.9/16	7314150131280	1	184
K9806Z-3	7314150131358	1	184
K9806Z-3.1/16	7314150131365	1	184
K9806Z-3.1/2	7314150131433	1	184
K9806Z-3.1/4	7314150131396	1	184
K9806Z-3.1/8	7314150131372	1	184
K9806Z-3.11/16	7314150131464	1	184
K9806Z-3.13/16	7314150131488	1	184
K9806Z-3.15/16	7314150131501	1	184
K9806Z-3.3/16	7314150131389	1	184
K9806Z-3.3/4	7314150131471	1	184
K9806Z-3.3/8	7314150131419	1	184
K9806Z-3.5/16	7314150131402	1	184
K9806Z-3.5/8	7314150131457	1	184
K9806Z-3.7/16	7314150131426	1	184
K9806Z-3.7/8	7314150131495	1	184
K9806Z-3.9/16	7314150131440	1	184
K9806Z-4	7314150131518	1	184
K9806Z-4.1/16	7314150131525	1	184
K9806Z-4.1/2	7314150131570	1	184
K9806Z-4.1/4	7314150131549	1	184
K9806Z-4.1/8	7314150131532	1	184
K9806Z-4.3/4	7314150131594	1	184
K9806Z-4.3/8	7314150131563	1	184
K9806Z-4.5/16	7314150131556	1	184
K9806Z-4.5/8	7314150131587	1	184
K9860H-1	7314150133994	1	184
K9860H-2	7314150134007	1	184
K9860H-3	7314150134014	1	184
K9867S	7314150133932	1	184
K9895G	7314150133949	1	183
K9899H	7314150166763	1	185
K9998H	7314150133963	1	185
KB09-01	7314150196968	5	581
KB18-01	7314150196944	5	581
KBFU-01	7314150196913	5	580
KBGH-5P-DISPEN	7314150296729	20	581
KBGR-5P-DISPEN	7314150296774	20	581
KBGU-100P	7314150213405	1	581
KBGU-10P-DISPEN	7314150262984	20	581
KBGU-5P-DISPEN	7314150296705	20	581
KBRU-01	7314150196876	5	580
KBSK-01	7314150196999	5	583
KBSU-01	7314150197002	5	583
KBTU-01	7314150196982	5	583
KBWS-01	7314150225972	10	586
KCB753	7314150204915	1	171
KE18-01	7314150196937	5	580
KEFU-01	7314150196906	5	580
KERU-01	7314150196869	5	580
KG09-01	7314150196975	5	581
KG09-01-3P	7314150213962	10	581
KG18-01	7314150196951	5	582
KGAU-01	7314150223893	5	582
KGFU-01	7314150196920	5	580
KGRU-01	7314150196883	5	580
KGRU-02	7314150196890	5	580
KGSU-01	7314150197019	5	583
KHU-01	7314150268955	4	582
KM1/4-5/16-1P	7314150275953	1	172
KM653-1P	7314151840709	1	171
KM653-5P	7314150533565	1	171
KM653-QR-1P	7314151848507	1	170
KM653-QR-5P	7314150533589	1	170
KM653-SF	7314150204984	1	171
KM6701M-10	7314151844264	1	173
KM6701M-7	7314151844240	1	173
KM6701M-8	7314151844257	1	173
KM6750-1/4	7314150204595	1	170
KM6750-10-1P	7314150533626	1	170
KM6750-11	7314150302628	1	170
KM6750-13-1P	7314150533664	1	170
KM6750-3/8	7314150204588	1	170
KM6750-6	7314150204601	1	170
KM6750-7	7314150204618	1	170



KM753-QR-1P



KM753-QR-1P	7314150204830	1	171
KMR150	7314150204960	1	171
KMR150-1P	7314150204977	1	171
KMR653-5P	7314150533763	1	171
KMR653-1P	7314150204939	1	171
KMR753	7314150204946	1	171
KMR753-1P	7314150204953	1	171
KMT753-QR-1P	7314150391523	1	171
KMU-01	7314150197026	5	580
KR653	7314150204885	1	171
KR653-1P	7314150260263	1	171
KRSS-01	7314150214938	10	586
KS7401M-10	7314150384495	1	174
KS7401M-11	7314150384501	1	174
KS7401M-12	7314150384518	1	174
KS7401M-13	7314150384525	1	174
KS7401M-14	7314150384532	1	174
KS7401M-15	7314150384549	1	174
KS7401M-16	7314150384556	1	174
KS7401M-17	7314150384563	1	174
KS7401M-18	7314150384570	1	174
KS7401M-19	7314150384587	1	174
KS7401M-22	7314150384594	1	174
KS7401M-9	7314150384600	1	174
KSBG09-10DISPEN	7314150262991	20	582
KSBG18-10DISPEN	7314150263004	20	582
KSR753	7314150204892	1	529
KSR753-1P	7314150204908	1	529
KUBG09-5P	7314150213450	20	582
KUBG18-5DISPEN	7314150296835	20	582
L1020I06	7314150501649	5	147
L1020M06	7311518133665	1	145
L1020M06X	7311518136369	1	145
L1020S06	7314150501670	5	147
L1225M06	7311518132774	1	145
L1225M06X	7311518136857	1	145
L1228I06	7314150501700	5	147
L1228S06	7314150501731	5	147
L1230AL06	7311518187668	1	146
L1230AL08	7311518181871	1	146
L1230M06	7311518182168	1	145
L1230M06X	7311518182175	1	145
L1630M06	7311518192914	1	145
L1630M06X	7311518187446	1	145
L1630M08	7311518182205	1	145
L1630M08X	7311518136833	1	145
LAP-KNIFE	7311518216443	10	635
LARGE	7314150437429	1	375
LS-6160-23	7311518041304	90	637
LS-COIN 19 CM	7311518031077	4	601
LS-COIN 26 CM	7311518333041	2	601
LS-COMBINESS	7311518041366	600	636
LS-MASSE-4	7311518012014	2	600
LS-MASSE-4FG	7311518275891	2	600
LS-MASSE-TR-4FG	7311518281106	2	601
LS-MERLIN-2.5	7311518012069	2	601
LS-MERLIN-2.5FG	7311518281113	2	601
LS-PIERRE CORINDON	7311518009977	1	636
LS-PIERRE-FAUX	7311518009038	90	637
LT-STEEL-30	7314150138012	5	539
LT-STEEL-50	7314150138029	5	539
LTB-10	7314150120048	6	539
LTB-20	7314150120062	6	539
LTB-30	7314150120086	6	539
LTG-10	7314150119981	6	539
LTG-20	7314150120000	6	539
LTG-30	7314150120024	6	539
LTS-100	7314150120147	5	539
LTS-100-E	7314150120154	5	539
LTS-30	7314150120109	5	539
LTS-30-E	7314150120116	5	539
LTS-50	7314150120123	5	539
LTS-50-E	7314150120130	5	539
LUB-2015	7311518335427	6	637
M0310M03	7311518036805	1	145
M0310M03X	7311518197063	1	145
M0613M03X	7311518196622	1	145
M0618M06	7311518036836	1	145
M0618M06X	7311518036850	1	145
M1022M06	7311518036881	1	145
M1022M06X	7311518036904	1	145
M1227M06	7311518036928	1	145
M1227M06X	7311518036959	1	145
M1227M08	7311518036980	1	145
M1630M06	7311518193010	1	145
M1630M06X	7311518187453	1	145
M1630M08	7311518037062	1	145
M1630M08X	7311518037086	1	145
M227L	7311518160883	4	577
M227R	7311518160869	4	578
M330	7311518160906	4	578
M526	7311518160982	4	578
M6376	7311518196486	1	578
M6376-SH	7311518199296	1	578
M676	7311518161088	1	578
M676-SH	7311518211875	1	578



M780	7314151826215	1	219
M781	7314153016218	5	219
M926	7311518161071	1	579
M926-SH	7314150107537	1	579
MA225	7311518161057	4	576
MA225L	7311518161033	4	576
MA225R	7311518161040	4	576
MA311	7314150181568	1	576
MA321	7314150181551	10	576
MA325	7311518161064	4	577
MA351	7314150181582	10	577
MA361	7314150181575	10	577
MA401	7314150167593	10	576
MA411	7314150167609	10	576
MA421	7314150167616	10	576
MA431	7314150181544	1	576
MA500-1A	7314150458882	1	654
MA500-2A	7314150458899	1	654
MA500-3A	7314150456925	1	654
MAM50M	7314150215300	1	115
MCP-2.5-810	7311518124052	2	600
MES-3.0-900	7311518123864	2	601
MES-3.5-900	7311518123871	2	601
MES-3.5-900FG	7311518281120	2	601
MK5	7314150224333	1	59
MK9	7314150224326	1	60
MONSTER	7314150437405	1	375
MR227L	7311518161002	4	578
MR227R	7311518160999	4	578
MR340	7311518197537	2	577
MT-TS-3	7314150194995	12	538
MTB-3-16	7314150119066	6	538
MTB-3-16-M	7314150119073	6	538
MTB-3-16-M-E	7314150119141	6	538
MTB-5-25	7314150119080	6	538
MTB-5-25-C1	7314150119127	6	538
MTB-5-25-M	7314150119097	6	538
MTB-5-25-M-E	7314150119158	6	538
MTB-8-25	7314150125418	6	538
MTB-8-25-M	7314150127078	6	538
MTB-8-25-M-E	7314150127085	6	538
MTC-3-13	7314150321322	6	538
MTC-3-13-C1	7314150330843	6	538
MTC-5-16	7314150321339	6	538
MTC-5-16-C1	7314150330850	6	538
MTG-3-16	7314150118984	12	538
MTG-3-16-E	7314150119028	12	538
MTG-5-19	7314150118991	12	538
MTG-5-19-E	7314150119035	12	538
MTG-8-25	7314150330348	4	538
MTG-8-25-E	7314150390809	4	538
MTS-5-25	7314150119233	6	538
MTS-5-25-E	7314150119271	6	538
MTS-8-25	7314150119257	6	538
MTS-8-25-E	7314150119295	6	538
MTT051	7314150270521	6	586
MTT121	7314150213290	8	586
MTT151	7314150120703	6	586
MW-150	7314150125685	2	539
MW-250	7314150125678	2	539
N0306M03	7311518182212	1	145
N0306M03E	7311518182229	1	145
N0607M06	7311518182236	1	145
N1213M06	7311518134570	1	145
N1213M06X	7311518237172	1	145
N1613M06	7311518136000	1	145
N1613M06X	7311518204525	1	145
N1613M08	7311518182267	1	145
NP-12-COM	7311518264277	4	560
NP-12-TEN	7311518263959	10	564
NP-12-VEN	7311518264260	10	564
NP-16-U7/8-HP	7311518241773	4	561
NP-19-U7/8-HP	7311518241452	10	561
NP-22-F7/8-HP	7311518035204	10	562
NP-22-U7/8-HP	7311518034399	10	561
NS001-150	7314150316069	5	506
NS001-200	7314150316076	5	506
NS001-250	7314150316083	5	506
NS001-300	7314150316090	5	506
NS001-375	7314150325108	5	506
NS001-450	7314150325115	3	506
NS001-600	7314150325122	1	506
NS001-900	7314150325139	1	506
NS002-10	7314150284719	10	506
NS002-11	7314150292592	5	506
NS002-12	7314150292608	5	506
NS002-13	7314150284726	10	506
NS002-14	7314150284733	5	506
NS002-15	7314150292615	5	506
NS002-16	7314150292622	5	506
NS002-17	7314150284740	10	506
NS002-18	7314150292639	5	506
NS002-19	7314150284757	10	506
NS002-20	7314150292646	5	506
NS002-21	7314150292653	5	506
NS002-22	7314150292660	10	506



NS002-23	7314150292677	5	506
NS002-24	7314150292684	10	506
NS002-25	7314150292691	5	506
NS002-26	7314150292707	5	506
NS002-27	7314150284764	5	506
NS002-28	7314150292714	5	506
NS002-29	7314150292721	10	506
NS002-30	7314150292738	10	506
NS002-31	7314150292745	5	506
NS002-32	7314150284771	5	506
NS002-33	7314150292752	5	506
NS002-34	7314150292769	5	506
NS002-35	7314150292776	5	506
NS002-36	7314150284788	5	506
NS002-38	7314150292783	5	506
NS002-40	7314150292790	5	506
NS002-41	7314150292806	5	506
NS002-42	7314150292813	5	506
NS002-46	7314150292820	5	506
NS002-50	7314150292837	5	506
NS002-52	7314150292844	5	506
NS002-55	7314150292851	5	506
NS002-6	7314150292554	5	506
NS002-60	7314150292868	1	506
NS002-65	7314150292875	1	506
NS002-7	7314150292561	5	506
NS002-70	7314150292882	1	506
NS002-75	7314150292899	1	506
NS002-8	7314150292578	5	506
NS002-80	7314150292905	1	506
NS002-9	7314150292585	5	506
NS003-11	7314150306602	1	506
NS003-12	7314150306619	1	506
NS003-14	7314150306626	1	506
NS003-16	7314150306633	1	506
NS003-18	7314150320356	1	506
NS003-20	7314150320363	1	506
NS003-24	7314150320370	1	506
NS003-28	7314150320387	1	506
NS003-30	7314150320394	1	506
NS003-8	7314150320349	1	506
NS006-0607	7314150292912	1	507
NS006-0608	7314150292929	1	507
NS006-0708	7314150292936	1	507
NS006-0709	7314150292943	1	507
NS006-0809	7314150292967	1	507
NS006-0810	7314150292950	1	507
NS006-0910	7314150292974	1	507
NS006-0911	7314150292981	1	507
NS006-1011	7314150292998	1	507
NS006-1012	7314150293001	1	507
NS006-1013	7314150293018	1	507
NS006-1014	7314150293025	1	507
NS006-1113	7314150293032	1	507
NS006-1114	7314150293049	1	507
NS006-1213	7314150293056	1	507
NS006-1214	7314150293063	1	507
NS006-1315	7314150293070	1	507
NS006-1415	7314150293087	1	507
NS006-1416	7314150293094	1	507
NS006-1417	7314150293100	1	507
NS006-1617	7314150293117	1	507
NS006-1618	7314150293124	1	507
NS006-1719	7314150293131	1	507
NS006-1722	7314150293148	1	507
NS006-1819	7314150293155	1	507
NS006-1820	7314150293162	1	507
NS006-1920	7314150293179	1	507
NS006-1922	7314150293186	1	507
NS006-1924	7314150293193	1	507
NS006-2022	7314150293209	1	507
NS006-2122	7314150293216	1	507
NS006-2123	7314150293223	1	507
NS006-2223	7314150293230	1	507
NS006-2224	7314150293247	1	507
NS006-2227	7314150293254	1	507
NS006-2326	7314150293261	1	507
NS006-2425	7314150293278	1	507
NS006-2426	7314150293285	1	507
NS006-2427	7314150293292	1	507
NS006-2430	7314150293308	1	507
NS006-2528	7314150293315	1	507
NS006-2629	7314150293322	1	507
NS006-2729	7314150293339	1	507
NS006-2730	7314150293346	1	507
NS006-2732	7314150293353	1	507
NS006-2830	7314150293360	1	507
NS006-3031	7314150293377	1	507
NS006-3032	7314150293384	1	507
NS006-3034	7314150293391	1	507
NS006-3036	7314150293407	1	507
NS006-3234	7314150293414	1	507
NS006-3235	7314150293421	1	507
NS006-3236	7314150293438	1	507
NS006-3335	7314150293445	1	507
NS006-3436	7314150293452	1	507



NS006-3536	7314150293469	1	507
NS006-3638	7314150293476	1	507
NS006-3641	7314150293483	1	507
NS006-3642	7314150293490	1	507
NS006-4146	7314150293506	1	507
NS006-4650	7314150293513	1	507
NS006-5052	7314150293520	1	507
NS006-5055	7314150293537	1	507
NS006-5060	7314150293544	1	507
NS006-5062	7314150293551	1	507
NS006-5560	7314150293568	1	507
NS006-6065	7314150293575	1	507
NS006-6570	7314150293582	1	507
NS010-0607	7314150293599	1	508
NS010-0709	7314150293605	1	508
NS010-0809	7314150293612	1	508
NS010-0911	7314150293629	1	508
NS010-1011	7314150293636	1	508
NS010-1012	7314150293643	1	508
NS010-1214	7314150293650	1	508
NS010-1315	7314150293667	1	508
NS010-1417	7314150293674	1	508
NS010-1618	7314150293681	1	508
NS010-1719	7314150293698	1	508
NS010-1722	7314150293704	1	508
NS010-1819	7314150293711	1	508
NS010-1921	7314150293728	1	508
NS010-1922	7314150293735	1	508
NS010-2022	7314150293742	1	508
NS010-2123	7314150293759	1	508
NS010-2224	7314150293766	1	508
NS010-2427	7314150293773	1	508
NS010-2528	7314150293780	1	508
NS010-2628	7314150293797	1	508
NS010-2730	7314150293803	1	508
NS010-2732	7314150293810	1	508
NS010-3032	7314150293827	1	508
NS010-3036	7314150293834	1	508
NS010-3236	7314150293841	1	508
NS010-3641	7314150293858	1	508
NS010-4146	7314150293865	1	508
NS010-4650	7314150293872	1	508
NS011-0607	7314150317271	1	508
NS011-0809	7314150317288	1	508
NS011-1011	7314150317295	1	508
NS011-1213	7314150317301	1	508
NS011-1415	7314150317318	1	508
NS011-1617	7314150317325	1	508
NS011-1819	7314150317332	1	508
NS011-2022	7314150317349	1	508
NS011-2123	7314150317356	1	508
NS011-2426	7314150317363	1	508
NS011-2528	7314150317370	1	508
NS011-2729	7314150317387	1	508
NS011-3032	7314150317394	1	508
NS041-12-50	7314150502547	1	524
NS041-16-100	7314150502561	1	524
NS041-16-200	7314150502332	1	524
NS041-16-260	7314150502585	1	524
NS041-24-670	7314150502608	1	524
NS041-32-900	7314150502622	1	524
NS041-8-25	7314150502646	1	524
NS100-100	7314150294305	1	509
NS100-105	7314150294312	1	509
NS100-110	7314150294329	1	509
NS100-115	7314150294336	1	509
NS100-120	7314150294343	1	509
NS100-17	7314150293889	1	508
NS100-19	7314150293896	1	508
NS100-22	7314150293902	1	508
NS100-24	7314150293919	1	508
NS100-25	7314150293926	1	508
NS100-27	7314150293933	1	508
NS100-28	7314150293940	1	508
NS100-29	7314150293957	1	508
NS100-30	7314150293964	1	508
NS100-32	7314150293971	1	508
NS100-33	7314150293988	1	508
NS100-34	7314150293995	1	508
NS100-35	7314150294008	1	508
NS100-36	7314150294015	1	508
NS100-37	7314150294022	1	508
NS100-38	7314150294039	1	508
NS100-41	7314150294046	1	508
NS100-42	7314150294053	1	508
NS100-45	7314150294060	1	509
NS100-46	7314150294077	1	509
NS100-47	7314150294084	1	509
NS100-50	7314150294091	1	509
NS100-52	7314150294107	1	509
NS100-54	7314150294114	1	509
NS100-55	7314150294121	1	509
NS100-56	7314150294138	1	509
NS100-58	7314150294145	1	509
NS100-60	7314150294152	1	509
NS100-63	7314150294169	1	509



NS100-65



NS100-65	7314150294176	1	509
NS100-67	7314150294183	1	509
NS100-70	7314150294190	1	509
NS100-71	7314150294206	1	509
NS100-75	7314150294213	1	509
NS100-77	7314150294220	1	509
NS100-80	7314150294237	1	509
NS100-82	7314150294244	1	509
NS100-85	7314150294251	1	509
NS100-88	7314150294268	1	509
NS100-90	7314150294275	1	509
NS100-94	7314150294282	1	509
NS100-95	7314150294299	1	509
NS104-100	7314150294947	1	509
NS104-105	7314150294954	1	509
NS104-110	7314150294961	1	509
NS104-115	7314150294978	1	509
NS104-120	7314150294985	1	509
NS104-17	7314150294350	1	509
NS104-19	7314150294367	1	509
NS104-20	7314150294374	1	509
NS104-22	7314150294381	1	509
NS104-24	7314150284795	1	509
NS104-25	7314150294398	1	509
NS104-26	7314150294404	1	509
NS104-27	7314150284801	1	509
NS104-28	7314150294411	1	509
NS104-29	7314150294428	1	509
NS104-30	7314150284818	1	509
NS104-31	7314150294435	1	509
NS104-32	7314150284825	1	509
NS104-33	7314150294442	1	509
NS104-34	7314150294459	1	509
NS104-35	7314150294466	1	509
NS104-36	7314150284832	1	509
NS104-37	7314150294473	1	509
NS104-38	7314150294480	1	509
NS104-39	7314150294497	1	509
NS104-40	7314150294503	1	509
NS104-41	7314150284849	1	509
NS104-42	7314150294510	1	509
NS104-43	7314150294527	1	509
NS104-44	7314150294534	1	509
NS104-45	7314150294541	1	509
NS104-46	7314150284856	1	509
NS104-47	7314150294558	1	509
NS104-48	7314150294565	1	509
NS104-49	7314150294572	1	509
NS104-50	7314150284863	1	509
NS104-51	7314150294589	1	509
NS104-52	7314150294596	1	509
NS104-53	7314150294602	1	509
NS104-54	7314150294619	1	509
NS104-55	7314150284870	1	509
NS104-56	7314150294626	1	509
NS104-57	7314150294633	1	509
NS104-58	7314150294640	1	509
NS104-59	7314150294657	1	509
NS104-60	7314150284887	1	509
NS104-61	7314150294664	1	509
NS104-62	7314150294671	1	509
NS104-63	7314150294688	1	509
NS104-64	7314150294695	1	509
NS104-65	7314150294701	1	509
NS104-66	7314150294718	1	509
NS104-67	7314150294725	1	509
NS104-68	7314150294732	1	509
NS104-69	7314150294749	1	509
NS104-70	7314150284894	1	509
NS104-71	7314150294756	1	509
NS104-72	7314150294763	1	509
NS104-73	7314150294770	1	509
NS104-74	7314150294787	1	509
NS104-75	7314150284900	1	509
NS104-76	7314150294794	1	509
NS104-77	7314150294800	1	509
NS104-78	7314150294817	1	509
NS104-79	7314150294824	1	509
NS104-80	7314150284917	1	509
NS104-81	7314150294831	1	509
NS104-82	7314150294848	1	509
NS104-83	7314150294855	1	509
NS104-84	7314150294862	1	509
NS104-85	7314150284924	1	509
NS104-86	7314150294879	1	509
NS104-87	7314150294886	1	509
NS104-88	7314150294893	1	509
NS104-89	7314150294909	1	509
NS104-90	7314150284931	1	509
NS104-92	7314150294916	1	509
NS104-94	7314150294923	1	509
NS104-95	7314150284948	1	509
NS104-98	7314150294930	1	509
NS106-100	7314150295418	1	510
NS106-104	7314150295425	1	510
NS106-108	7314150295432	1	510



NS106-112	7314150295449	1	510
NS106-114	7314150295456	1	510
NS106-116	7314150295463	1	510
NS106-120	7314150295470	1	510
NS106-124	7314150295487	1	510
NS106-126	7314150295494	1	510
NS106-128	7314150295500	1	510
NS106-132	7314150295517	1	510
NS106-136	7314150295524	1	510
NS106-138	7314150295531	1	510
NS106-144	7314150295548	1	510
NS106-146	7314150295555	1	510
NS106-150	7314150295562	1	510
NS106-156	7314150295579	1	510
NS106-158	7314150295586	1	510
NS106-20	7314150294992	1	510
NS106-22	7314150295005	1	510
NS106-24	7314150295012	1	510
NS106-25	7314150295029	1	510
NS106-26	7314150295036	1	510
NS106-28	7314150295043	1	510
NS106-30	7314150295050	1	510
NS106-32	7314150295067	1	510
NS106-34	7314150295074	1	510
NS106-36	7314150295081	1	510
NS106-38	7314150295098	1	510
NS106-40	7314150295104	1	510
NS106-42	7314150295111	1	510
NS106-44	7314150295128	1	510
NS106-45	7314150295135	1	510
NS106-46	7314150295142	1	510
NS106-48	7314150295159	1	510
NS106-50	7314150295166	1	510
NS106-52	7314150295173	1	510
NS106-54	7314150295180	1	510
NS106-56	7314150295197	1	510
NS106-58	7314150295203	1	510
NS106-60	7314150295210	1	510
NS106-62	7314150295227	1	510
NS106-64	7314150295234	1	510
NS106-66	7314150295241	1	510
NS106-68	7314150295258	1	510
NS106-70	7314150295265	1	510
NS106-71	7314150295272	1	510
NS106-72	7314150295289	1	510
NS106-74	7314150295296	1	510
NS106-76	7314150295302	1	510
NS106-78	7314150295319	1	510
NS106-80	7314150295326	1	510
NS106-82	7314150295333	1	510
NS106-84	7314150295340	1	510
NS106-88	7314150295357	1	510
NS106-90	7314150295364	1	510
NS106-92	7314150295371	1	510
NS106-94	7314150295388	1	510
NS106-96	7314150295395	1	510
NS106-98	7314150295401	1	510
NS200-1200	7314150295661	1	511
NS200-200	7314150295593	1	511
NS200-250	7314150295609	1	511
NS200-300	7314150295616	1	511
NS200-350	7314150295623	1	511
NS200-450	7314150295630	1	511
NS200-600	7314150295647	1	511
NS200-900	7314150295654	1	511
NS202-350	7314150299690	1	511
NS203-200	7314150359509	1	511
NS203-215	7314150359516	1	511
NS203-290	7314150359523	1	511
NS203-400	7314150359530	1	511
NS203-490	7314150359547	1	511
NS203-800	7314150359554	1	511
NS204-30	7314150295685	1	511
NS204-32	7314150295692	1	511
NS204-35	7314150295708	1	511
NS204-40	7314150295715	1	511
NS204-45	7314150295722	1	511
NS204-48	7314150295739	1	511
NS204-50	7314150295746	1	511
NS204-55	7314150295753	1	511
NS204-60	7314150295760	1	511
NS204-65	7314150295777	1	511
NS204-70	7314150295784	1	511
NS204-75	7314150295791	1	511
NS204-80	7314150295807	1	511
NS204-85	7314150295814	1	511
NS204-90	7314150295821	1	511
NS220-06	7314150347216	1	512
NS220-07	7314150347223	1	512
NS220-08	7314150347230	1	512
NS220-09	7314150347247	1	512
NS220-10	7314150347254	1	512
NS220-11	7314150347261	1	512
NS220-12	7314150347278	1	512
NS220-13	7314150347285	1	512
NS220-14	7314150347292	1	512



NS220-15	7314150347308	1	512
NS220-16	7314150347315	1	512
NS220-17	7314150347322	1	512
NS220-18	7314150347339	1	512
NS220-19	7314150347346	1	512
NS220-20	7314150347353	1	512
NS220-21	7314150347360	1	512
NS220-22	7314150347377	1	512
NS220-23	7314150347384	1	512
NS220-24	7314150347391	1	512
NS220-25	7314150347407	1	512
NS220-26	7314150347414	1	512
NS220-27	7314150347421	1	512
NS220-28	7314150347438	1	512
NS220-29	7314150347445	1	512
NS220-30	7314150347452	1	512
NS220-32	7314150347469	1	512
NS220-34	7314150347476	1	512
NS220-36	7314150347483	1	512
NS220-41	7314150347490	1	512
NS224-17	7314150355525	1	512
NS224-18	7314150355532	1	512
NS224-19	7314150355549	1	512
NS224-21	7314150355556	1	512
NS224-22	7314150355563	1	512
NS224-23	7314150355570	1	512
NS224-24	7314150355587	1	512
NS224-26	7314150355594	1	512
NS224-27	7314150355617	1	512
NS224-28	7314150355624	1	512
NS224-29	7314150355631	1	512
NS224-30	7314150355648	1	512
NS224-32	7314150355655	1	512
NS224-34	7314150355662	1	512
NS224-36	7314150355679	1	512
NS224-38	7314150355686	1	512
NS224-41	7314150355693	1	512
NS224-46	7314150355709	1	512
NS224-50	7314150355716	1	512
NS228-22	7314150355914	1	513
NS228-24	7314150355921	1	513
NS228-26	7314150355938	1	513
NS228-27	7314150355945	1	513
NS228-28	7314150355952	1	513
NS228-29	7314150355969	1	513
NS228-30	7314150355976	1	513
NS228-31	7314150355983	1	513
NS228-32	7314150355990	1	513
NS228-34	7314150356003	1	513
NS228-36	7314150356010	1	513
NS228-38	7314150356027	1	513
NS228-41	7314150356034	1	513
NS228-46	7314150356041	1	513
NS228-50	7314150356058	1	513
NS228-55	7314150356065	1	513
NS228-60	7314150356072	1	513
NS228-65	7314150356089	1	513
NS228-70	7314150356096	1	513
NS228-75	7314150356102	1	513
NS228-80	7314150356119	1	513
NS232-16-24	7314150356331	1	513
NS232-24-16	7314150356355	1	513
NS232-24-32	7314150356348	1	513
NS232-32-24	7314150356362	1	513
NS234-16-100	7314150356416	1	513
NS234-16-200	7314150356423	1	513
NS234-16-250	7314150356430	1	513
NS234-24-200	7314150356447	1	513
NS234-32-250	7314150356454	1	513
NS236-16	7314150356522	1	513
NS236-24	7314150356539	1	513
NS236-32	7314150356515	1	513
NS238-16-250	7314150356577	1	514
NS238-24-250	7314150356584	1	514
NS238-32-300	7314150356591	1	514
NS240-16-230	7314150356737	1	514
NS242-16	7314150356638	1	514
NS242-24	7314150356645	1	514
NS242-32	7314150356652	1	514
NS243-16-400	7314150356690	1	514
NS247-26	7314150356751	1	515
NS248-16-52	7314150356713	1	515
NS300-10-200	7314150317783	1	515
NS300-10-300	7314150316205	1	515
NS300-11-250	7314150317790	1	515
NS300-11-300	7314150317806	1	515
NS300-11-350	7314150316212	1	515
NS300-12-400	7314150325153	1	515
NS300-13-450	7314150325160	1	515
NS300-3-50	7314150317677	1	515
NS300-3-75	7314150317684	1	515
NS300-4-75	7314150317691	1	515
NS300-4.5-100	7314150316175	1	515
NS300-4.5-50	7314150317707	1	515
NS300-5-100	7314150317721	1	515
NS300-5-75	7314150317714	1	515



NS300-6-100	7314150316182	1	515
NS300-6-125	7314150317738	1	515
NS300-6-150	7314150317745	1	515
NS300-7-150	7314150317752	1	515
NS300-8-150	7314150316199	1	515
NS300-8-200	7314150317769	1	515
NS300-9-250	7314150317776	1	515
NS301-10-200	7314150317882	1	515
NS301-10-300	7314150317899	1	515
NS301-3-50	7314150317813	1	515
NS301-4-100	7314150317820	1	515
NS301-4-150	7314150317837	1	515
NS301-5-100	7314150317844	1	515
NS301-5-200	7314150317851	1	515
NS301-6-100	7314150317868	1	515
NS301-8-150	7314150317875	1	515
NS302-0-50	7314150316229	1	516
NS302-1-100	7314150316236	1	516
NS302-2-125	7314150316243	1	516
NS302-3-150	7314150316250	1	516
NS302-4-300	7314150316267	1	516
NS304-0-50	7314150316274	1	516
NS304-1-100	7314150316281	1	516
NS304-2-125	7314150316298	1	516
NS304-3-150	7314150316304	1	516
NS304-4-300	7314150316311	1	516
NS320-10	7314150318162	1	516
NS320-2	7314150318087	1	516
NS320-3	7314150318094	1	516
NS320-4	7314150318100	1	516
NS320-5	7314150318117	1	516
NS320-6	7314150318124	1	516
NS320-7	7314150318131	1	516
NS320-8	7314150318148	1	516
NS320-9	7314150318155	1	516
NS400-160	7314150316106	1	516
NS400-180	7314150316113	1	516
NS400-200	7314150316120	1	516
NS402-160	7314150316137	1	517
NS402-200	7314150325177	1	517
NS403-160	7314150318209	1	517
NS403-180	7314150318193	1	517
NS404-160	7314150318216	1	517
NS405-160	7314150318247	1	517
NS406-160	7314150316144	1	517
NS406-180	7314150318261	1	517
NS406-200	7314150316151	1	517
NS407-160	7314150318278	1	517
NS408-250	7314150316168	1	518
NS408-300	7314150318292	1	518
NS411-200	7314150318322	1	518
NS412-200	7314150318339	1	518
NS413-180	7314150318384	1	518
NS413-200	7314150318377	1	518
NS500-1000-FB	7314150296019	1	519
NS500-1500-FB	7314150296026	1	519
NS500-2000	7314150291847	1	519
NS500-2000-FB	7314150284955	1	519
NS500-2500	7314150291854	1	518
NS500-2500-FB	7314150284962	1	519
NS500-3000	7314150291861	1	518
NS500-3000-FB	7314150284979	1	519
NS500-3500-FB	7314150284986	1	519
NS500-4000	7314150291878	1	518
NS502-1000-FB	7314150284993	1	519
NS502-10000-FB	7314150285068	1	519
NS502-12000-FB	7314150318407	1	519
NS502-1500-FB	7314150318438	1	519
NS502-2000-FB	7314150285006	1	519
NS502-2500-FB	7314150285013	1	519
NS502-3000-FB	7314150285020	1	519
NS502-450-FB	7314150296033	1	519
NS502-4500-FB	7314150285037	1	519
NS502-5000-FB	7314150285044	1	519
NS502-6800-FB	7314150318445	1	519
NS502-8000-FB	7314150285051	1	519
NS504-100-FB	7314150296040	1	519
NS504-1000-FB	7314150285099	1	519
NS504-1500-FB	7314150285105	1	519
NS504-200-FB	7314150296057	1	519
NS504-2000-FB	7314150285112	1	519
NS504-300-FB	7314150296064	1	519
NS504-500-FB	7314150285075	1	519
NS504-800-FB	7314150285082	1	519
NS506-300	7314150285129	1	519
NS506-300-FB	7314150318469	1	520
NS506-450	7314150285136	1	519
NS506-450-FB	7314150318476	1	520
NS506-700	7314150296071	1	519
NS506-700-FB	7314150285143	1	520
NS506-900	7314150296088	1	519
NS506-900-FB	7314150285150	1	520
NS508-500-FB	7314150318544	1	520
NS508-700-FB	7314150318537	1	520
NS512-200-FB	7314150318568	1	520
NS512-400-FB	7314150318575	1	520





NS512-600-FB	7314150318582	1	520
NS512-900-FB	7314150318599	1	520
NS600-100-50	7314150296101	1	520
NS600-135-50	7314150296118	1	520
NS600-150-25	7314150296125	1	520
NS600-150-30	7314150301676	1	520
NS600-150-40	7314150296132	1	520
NS600-150-50	7314150296149	1	520
NS600-180-13	7314150296156	1	520
NS600-180-32	7314150285167	1	520
NS600-180-50	7314150285174	1	520
NS600-200-20	7314150296163	1	520
NS600-200-30	7314150296170	1	520
NS600-200-40	7314150296187	1	520
NS600-200-50	7314150301782	1	520
NS600-230-40	7314150296194	1	520
NS600-250-40	7314150296200	1	520
NS600-300-50	7314150296217	1	520
NS600-80-13	7314150296095	1	520
NS602-460	7314150285181	1	521
NS602-600	7314150285198	1	521
NS602-760	7314150296224	1	521
NS602-900	7314150296231	1	521
NS604-150	7314150296248	1	521
NS604-200	7314150285204	1	521
NS604-300	7314150285211	1	521
NS606-150	7314150285228	1	521
NS606-200	7314150285235	1	521
NS606-250	7314150285242	1	521
NS606-300	7314150285259	1	521
NS606-400	7314150285266	1	521
NS608-100	7314150285273	1	521
NS700-300	7314150325184	1	521
NS702-200	7314150325191	1	522
NS704-225	7314150325207	1	522
NS706-50	7314150325214	1	522
NS706-80	7314150325221	1	522
NS708-360	7314150325238	1	522
NS710-450	7314150325245	1	523
NS800-1100	7314150296323	1	523
NS800-1700	7314150285280	1	523
NS800-2000	7314150296330	1	523
NS802-290	7314150285297	1	523
NS804-290	7314150296347	1	523
NS810-100	7314150318728	1	523
NS810-150	7314150318711	1	523
NS810-200	7314150318704	1	523
NS810-350	7314150318698	1	523
NSB001-150	7314150292509	5	506
NSB001-200	7314150284689	5	506
NSB001-250	7314150284696	5	506
NSB001-300	7314150284702	5	506
NSB001-375	7314150292516	5	506
NSB001-450	7314150292523	3	506
NSB001-600	7314150292530	3	506
NSB001-900	7314150292547	1	506
NSB002-10	7314150316366	5	506
NSB002-11	7314150316373	5	506
NSB002-12	7314150316380	5	506
NSB002-13	7314150316397	5	506
NSB002-14	7314150316403	5	506
NSB002-15	7314150316410	5	506
NSB002-16	7314150316427	5	506
NSB002-17	7314150316434	5	506
NSB002-18	7314150316441	5	506
NSB002-19	7314150316458	5	506
NSB002-20	7314150316465	5	506
NSB002-21	7314150316472	5	506
NSB002-22	7314150316489	5	506
NSB002-23	7314150316496	5	506
NSB002-24	7314150316502	5	506
NSB002-25	7314150316519	5	506
NSB002-26	7314150316526	5	506
NSB002-27	7314150316533	5	506
NSB002-28	7314150316540	5	506
NSB002-29	7314150316557	5	506
NSB002-30	7314150316564	5	506
NSB002-31	7314150321728	1	506
NSB002-32	7314150316571	10	506
NSB002-33	7314150321735	1	506
NSB002-34	7314150321742	1	506
NSB002-35	7314150321759	1	506
NSB002-36	7314150321766	5	506
NSB002-38	7314150321773	1	506
NSB002-40	7314150321780	1	506
NSB002-41	7314150321797	5	506
NSB002-42	7314150321803	1	506
NSB002-46	7314150321810	1	506
NSB002-50	7314150321827	1	506
NSB002-52	7314150321834	1	506
NSB002-55	7314150321841	1	506
NSB002-6	7314150316328	5	506
NSB002-60	7314150321858	1	506
NSB002-65	7314150321865	1	506
NSB002-7	7314150316335	5	506
NSB002-70	7314150321872	1	506



NSB002-75	7314150321889	1	506
NSB002-8	7314150316342	5	506
NSB002-80	7314150321896	1	506
NSB002-9	7314150316359	5	506
NSB003-10	7314150342709	1	506
NSB003-11	7314150342716	1	506
NSB003-12	7314150342723	5	506
NSB003-13	7314150342730	1	507
NSB003-14	7314150342747	1	507
NSB003-16	7314150342754	5	507
NSB003-18	7314150342761	1	507
NSB003-19	7314150342778	1	507
NSB003-20	7314150342785	1	507
NSB003-22	7314150342792	5	507
NSB003-24	7314150342808	5	507
NSB003-25	7314150342815	1	507
NSB003-26	7314150342822	1	507
NSB003-28	7314150342839	5	507
NSB003-30	7314150342846	1	507
NSB003-31	7314150342853	1	507
NSB003-32	7314150342860	1	507
NSB003-34	7314150342877	1	507
NSB003-36	7314150342884	1	507
NSB003-38	7314150342891	1	507
NSB003-40	7314150342907	1	507
NSB003-42	7314150342914	1	507
NSB003-44	7314150342921	5	507
NSB003-46	7314150342938	1	507
NSB003-48	7314150342945	1	507
NSB003-50	7314150342952	1	507
NSB003-52	7314150342969	1	507
NSB003-54	7314150342976	1	507
NSB003-56	7314150342983	1	507
NSB003-58	7314150342990	1	507
NSB003-60	7314150343010	1	507
NSB003-62	7314150343027	1	507
NSB003-64	7314150343034	5	507
NSB003-68	7314150343041	1	507
NSB003-72	7314150343058	1	507
NSB003-8	7314150342693	1	506
NSB003-80	7314150343065	1	507
NSB003-84	7314150343072	1	507
NSB003-88	7314150343089	1	507
NSB006-0607	7314150316588	1	507
NSB006-0608	7314150321926	1	507
NSB006-0708	7314150321933	1	507
NSB006-0709	7314150321940	1	507
NSB006-0809	7314150316595	1	507
NSB006-0810	7314150321957	1	507
NSB006-0910	7314150321964	1	507
NSB006-0911	7314150321971	1	507
NSB006-1011	7314150316601	1	507
NSB006-1012	7314150322015	1	507
NSB006-1013	7314150322022	1	507
NSB006-1014	7314150322039	1	507
NSB006-1113	7314150322046	1	507
NSB006-1114	7314150322053	1	507
NSB006-1213	7314150316618	1	507
NSB006-1214	7314150322060	1	507
NSB006-1315	7314150322077	1	507
NSB006-1415	7314150316625	1	507
NSB006-1416	7314150322084	1	507
NSB006-1417	7314150322091	1	507
NSB006-1617	7314150316632	1	507
NSB006-1618	7314150322107	1	507
NSB006-1719	7314150322114	1	507
NSB006-1722	7314150322121	1	507
NSB006-1819	7314150316649	1	507
NSB006-1820	7314150322138	1	507
NSB006-1920	7314150322145	1	507
NSB006-1922	7314150322152	1	507
NSB006-1924	7314150322169	1	507
NSB006-2022	7314150316656	1	507
NSB006-2122	7314150322176	1	507
NSB006-2123	7314150316663	1	507
NSB006-2223	7314150322183	1	507
NSB006-2224	7314150322190	1	507
NSB006-2227	7314150322206	1	507
NSB006-2326	7314150322213	1	507
NSB006-2425	7314150322220	1	507
NSB006-2426	7314150316670	1	507
NSB006-2427	7314150322237	1	507
NSB006-2430	7314150322244	1	507
NSB006-2528	7314150316687	1	507
NSB006-2629	7314150322251	1	507
NSB006-2729	7314150316694	1	507
NSB006-2730	7314150322336	1	507
NSB006-2732	7314150322343	1	507
NSB006-2830	7314150322350	1	507
NSB006-3031	7314150322367	1	507
NSB006-3032	7314150316700	1	507
NSB006-3034	7314150322374	1	507
NSB006-3036	7314150322381	1	507
NSB006-3234	7314150322398	1	507
NSB006-3235	7314150322404	1	507
NSB006-3236	7314150322411	1	507



NSB006-3335	7314150322428	1	507
NSB006-3436	7314150322435	1	507
NSB006-3536	7314150322442	1	507
NSB006-3638	7314150322459	1	507
NSB006-3641	7314150322466	1	507
NSB006-3642	7314150322473	1	507
NSB006-4146	7314150322480	1	507
NSB006-4650	7314150322497	1	507
NSB006-5052	7314150322503	1	507
NSB006-5055	7314150322510	1	507
NSB006-5060	7314150322527	1	507
NSB006-5062	7314150322534	1	507
NSB006-5560	7314150322558	1	507
NSB006-6065	7314150322565	1	507
NSB006-6570	7314150322572	1	507
NSB010-0607	7314150322589	1	508
NSB010-0709	7314150322596	1	508
NSB010-0809	7314150322602	1	508
NSB010-0911	7314150322619	1	508
NSB010-1011	7314150322626	1	508
NSB010-1012	7314150322633	1	508
NSB010-1214	7314150322640	1	508
NSB010-1315	7314150322657	1	508
NSB010-1417	7314150322664	1	508
NSB010-1618	7314150322671	1	508
NSB010-1719	7314150322688	1	508
NSB010-1722	7314150322695	1	508
NSB010-1819	7314150322718	1	508
NSB010-1921	7314150322725	1	508
NSB010-1922	7314150322732	1	508
NSB010-2022	7314150322749	1	508
NSB010-2123	7314150322756	1	508
NSB010-2224	7314150322763	1	508
NSB010-2427	7314150322770	1	508
NSB010-2528	7314150322787	1	508
NSB010-2628	7314150322794	1	508
NSB010-2730	7314150322800	1	508
NSB010-2732	7314150322817	1	508
NSB010-3032	7314150322824	1	508
NSB010-3036	7314150322831	1	508
NSB010-3236	7314150322848	1	508
NSB010-3641	7314150322855	1	508
NSB010-4146	7314150322862	1	508
NSB010-4650	7314150322879	1	508
NSB011-0607	7314150317400	1	508
NSB011-0809	7314150317417	1	508
NSB011-1011	7314150317424	1	508
NSB011-1213	7314150317431	1	508
NSB011-1415	7314150317448	1	508
NSB011-1617	7314150317455	1	508
NSB011-1819	7314150317462	1	508
NSB011-2022	7314150317479	1	508
NSB011-2123	7314150317486	1	508
NSB011-2426	7314150317493	1	508
NSB011-2528	7314150317509	1	508
NSB011-2729	7314150317516	1	508
NSB011-3032	7314150317523	1	508
NSB041-12-50	7314150502660	1	524
NSB041-16-100	7314150502684	1	524
NSB041-16-200	7314150502318	1	524
NSB041-16-260	7314150502707	1	524
NSB041-24-670	7314150502721	1	524
NSB041-32-900	7314150502745	1	524
NSB041-8-25	7314150502769	1	524
NSB100-100	7314150323302	1	509
NSB100-105	7314150323319	1	509
NSB100-110	7314150323326	1	509
NSB100-115	7314150323333	1	509
NSB100-120	7314150323340	1	509
NSB100-17	7314150322886	1	509
NSB100-19	7314150322893	1	509
NSB100-22	7314150322909	1	509
NSB100-24	7314150322916	1	509
NSB100-25	7314150322923	1	509
NSB100-27	7314150322930	1	509
NSB100-28	7314150322947	1	509
NSB100-29	7314150322954	1	509
NSB100-30	7314150322961	1	509
NSB100-32	7314150322978	1	509
NSB100-33	7314150322985	1	509
NSB100-34	7314150322992	1	509
NSB100-35	7314150323005	1	509
NSB100-36	7314150323012	1	509
NSB100-37	7314150323029	1	509
NSB100-38	7314150323036	1	509
NSB100-41	7314150323043	1	509
NSB100-42	7314150323050	1	509
NSB100-45	7314150323067	1	509
NSB100-46	7314150323074	1	509
NSB100-47	7314150323081	1	509
NSB100-50	7314150323098	1	509
NSB100-52	7314150323104	1	509
NSB100-54	7314150323111	1	509
NSB100-55	7314150323128	1	509
NSB100-56	7314150323135	1	509
NSB100-58	7314150323142	1	509



NSB100-60	7314150323159	1	509
NSB100-63	7314150323166	1	509
NSB100-65	7314150323173	1	509
NSB100-67	7314150323180	1	509
NSB100-70	7314150323197	1	509
NSB100-71	7314150323203	1	509
NSB100-75	7314150323210	1	509
NSB100-77	7314150323227	1	509
NSB100-80	7314150323234	1	509
NSB100-82	7314150323241	1	509
NSB100-85	7314150323258	1	509
NSB100-88	7314150323265	1	509
NSB100-90	7314150323272	1	509
NSB100-94	7314150323289	1	509
NSB100-95	7314150323296	1	509
NSB104-100	7314150316885	1	510
NSB104-105	7314150316892	1	510
NSB104-110	7314150316908	1	510
NSB104-115	7314150323937	1	510
NSB104-120	7314150316915	1	510
NSB104-17	7314150323357	1	510
NSB104-19	7314150323364	1	510
NSB104-20	7314150323371	1	510
NSB104-22	7314150323388	1	510
NSB104-24	7314150316717	1	510
NSB104-25	7314150323395	1	510
NSB104-26	7314150323401	1	510
NSB104-27	7314150316724	1	510
NSB104-28	7314150323418	1	510
NSB104-29	7314150323425	1	510
NSB104-30	7314150316731	1	510
NSB104-31	7314150323432	1	510
NSB104-32	7314150316748	1	510
NSB104-33	7314150323449	1	510
NSB104-34	7314150323456	1	510
NSB104-35	7314150323463	1	510
NSB104-36	7314150316755	1	510
NSB104-37	7314150323470	1	510
NSB104-38	7314150323487	1	510
NSB104-39	7314150323494	1	510
NSB104-40	7314150323500	1	510
NSB104-41	7314150316762	1	510
NSB104-42	7314150323517	1	510
NSB104-43	7314150323524	1	510
NSB104-44	7314150323531	1	510
NSB104-45	7314150323548	1	510
NSB104-46	7314150316779	1	510
NSB104-47	7314150323555	1	510
NSB104-48	7314150323562	1	510
NSB104-49	7314150323579	1	510
NSB104-50	7314150316786	1	510
NSB104-51	7314150323586	1	510
NSB104-52	7314150323593	1	510
NSB104-53	7314150323609	1	510
NSB104-54	7314150323616	1	510
NSB104-55	7314150316793	1	510
NSB104-56	7314150323623	1	510
NSB104-57	7314150323630	1	510
NSB104-58	7314150323647	1	510
NSB104-59	7314150323654	1	510
NSB104-60	7314150316809	1	510
NSB104-61	7314150323661	1	510
NSB104-62	7314150323678	1	510
NSB104-63	7314150323685	1	510
NSB104-64	7314150323692	1	510
NSB104-65	7314150316816	1	510
NSB104-66	7314150323708	1	510
NSB104-67	7314150323715	1	510
NSB104-68	7314150323722	1	510
NSB104-69	7314150323739	1	510
NSB104-70	7314150316823	1	510
NSB104-71	7314150323746	1	510
NSB104-72	7314150323753	1	510
NSB104-73	7314150323760	1	510
NSB104-74	7314150323777	1	510
NSB104-75	7314150316830	1	510
NSB104-76	7314150323784	1	510
NSB104-77	7314150323791	1	510
NSB104-78	7314150323807	1	510
NSB104-79	7314150323814	1	510
NSB104-80	7314150316847	1	510
NSB104-81	7314150323821	1	510
NSB104-82	7314150323838	1	510
NSB104-83	7314150323845	1	510
NSB104-84	7314150323852	1	510
NSB104-85	7314150316854	1	510
NSB104-86	7314150323869	1	510
NSB104-87	7314150323876	1	510
NSB104-88	7314150323883	1	510
NSB104-89	7314150323890	1	510
NSB104-90	7314150316861	1	510
NSB104-92	7314150323906	1	510
NSB104-94	7314150323913	1	510
NSB104-95	7314150316878	1	510
NSB104-98	7314150323920	1	510
NSB106-100	7314150324361	1	511





NSB106-104	7314150324378	1	511
NSB106-108	7314150324385	1	511
NSB106-112	7314150324392	1	511
NSB106-114	7314150324408	1	511
NSB106-116	7314150324415	1	511
NSB106-120	7314150324422	1	511
NSB106-124	7314150324439	1	511
NSB106-126	7314150324446	1	511
NSB106-128	7314150324453	1	511
NSB106-132	7314150324460	1	511
NSB106-136	7314150324477	1	511
NSB106-138	7314150324484	1	511
NSB106-144	7314150324491	1	511
NSB106-146	7314150324507	1	511
NSB106-150	7314150324514	1	511
NSB106-156	7314150324521	1	511
NSB106-158	7314150324538	1	511
NSB106-20	7314150323944	1	510
NSB106-22	7314150323951	1	510
NSB106-24	7314150323968	1	510
NSB106-25	7314150323975	1	510
NSB106-26	7314150323982	1	510
NSB106-28	7314150323999	1	510
NSB106-30	7314150324002	1	510
NSB106-32	7314150324019	1	510
NSB106-34	7314150324026	1	510
NSB106-36	7314150324033	1	510
NSB106-38	7314150324040	1	510
NSB106-40	7314150324057	1	510
NSB106-42	7314150324064	1	510
NSB106-44	7314150324071	1	510
NSB106-45	7314150324088	1	510
NSB106-46	7314150324095	1	510
NSB106-48	7314150324101	1	510
NSB106-50	7314150324118	1	510
NSB106-52	7314150324125	1	510
NSB106-54	7314150324132	1	510
NSB106-56	7314150324149	1	510
NSB106-58	7314150324156	1	510
NSB106-60	7314150324163	1	510
NSB106-62	7314150324170	1	511
NSB106-64	7314150324187	1	511
NSB106-66	7314150324194	1	511
NSB106-68	7314150324200	1	511
NSB106-70	7314150324217	1	511
NSB106-71	7314150324224	1	511
NSB106-72	7314150324231	1	511
NSB106-74	7314150324248	1	511
NSB106-76	7314150324255	1	511
NSB106-78	7314150324262	1	511
NSB106-80	7314150324279	1	511
NSB106-82	7314150324286	1	511
NSB106-84	7314150324293	1	511
NSB106-88	7314150324309	1	511
NSB106-90	7314150324316	1	511
NSB106-92	7314150324323	1	511
NSB106-94	7314150324330	1	511
NSB106-96	7314150324347	1	511
NSB106-98	7314150324354	1	511
NSB200-1200	7314150324613	1	511
NSB200-200	7314150324545	1	511
NSB200-250	7314150324552	1	511
NSB200-300	7314150324569	1	511
NSB200-350	7314150324576	1	511
NSB200-450	7314150324583	1	511
NSB200-600	7314150324590	1	511
NSB200-900	7314150324606	1	511
NSB202-350	7314150324620	1	511
NSB203-200	7314150359561	1	511
NSB203-215	7314150359578	1	511
NSB203-290	7314150359585	1	511
NSB203-400	7314150359592	1	511
NSB203-490	7314150359608	1	511
NSB203-800	7314150359615	1	511
NSB204-30	7314150324637	1	512
NSB204-32	7314150324644	1	512
NSB204-35	7314150324651	1	512
NSB204-40	7314150324668	1	512
NSB204-45	7314150324675	1	512
NSB204-48	7314150324682	1	512
NSB204-50	7314150324699	1	512
NSB204-55	7314150324705	1	512
NSB204-60	7314150324712	1	512
NSB204-65	7314150324729	1	512
NSB204-70	7314150324736	1	512
NSB204-75	7314150324743	1	512
NSB204-80	7314150324750	1	512
NSB204-85	7314150324767	1	512
NSB204-90	7314150324774	1	512
NSB220-06	7314150354023	1	512
NSB220-07	7314150354030	1	512
NSB220-08	7314150354047	1	512
NSB220-09	7314150354054	1	512
NSB220-10	7314150354061	1	512
NSB220-11	7314150354078	1	512
NSB220-12	7314150354085	1	512

NSB220-13	7314150354092	1	512
NSB220-14	7314150354108	1	512
NSB220-15	7314150354115	1	512
NSB220-16	7314150354122	1	512
NSB220-17	7314150354139	1	512
NSB220-18	7314150354146	1	512
NSB220-19	7314150354153	1	512
NSB220-20	7314150354160	1	512
NSB220-21	7314150354177	1	512
NSB220-22	7314150354184	1	512
NSB220-23	7314150354191	1	512
NSB220-24	7314150354207	1	512
NSB220-25	7314150354214	1	512
NSB220-26	7314150354221	1	512
NSB220-27	7314150354238	1	512
NSB220-28	7314150354245	1	512
NSB220-29	7314150354252	1	512
NSB220-30	7314150354269	1	512
NSB220-32	7314150354276	1	512
NSB224-17	7314150355723	1	512
NSB224-18	7314150355730	1	512
NSB224-19	7314150355747	1	512
NSB224-21	7314150355754	1	512
NSB224-22	7314150355761	1	512
NSB224-23	7314150355778	1	512
NSB224-24	7314150355785	1	512
NSB224-26	7314150355792	1	512
NSB224-27	7314150355808	1	512
NSB224-28	7314150355815	1	512
NSB224-29	7314150355822	1	512
NSB224-30	7314150355839	1	512
NSB224-32	7314150355846	1	512
NSB224-34	7314150355853	1	512
NSB224-36	7314150355860	1	512
NSB224-38	7314150355877	1	512
NSB224-41	7314150355884	1	512
NSB224-46	7314150355891	1	513
NSB224-50	7314150355907	1	513
NSB228-22	7314150356126	1	513
NSB228-24	7314150356133	1	513
NSB228-26	7314150356140	1	513
NSB228-27	7314150356157	1	513
NSB228-28	7314150356164	1	513
NSB228-29	7314150356171	1	513
NSB228-30	7314150356188	1	513
NSB228-31	7314150356195	1	513
NSB228-32	7314150356201	1	513
NSB228-34	7314150356218	1	513
NSB228-35	7314150356225	1	513
NSB228-38	7314150356232	1	513
NSB228-41	7314150356249	1	513
NSB228-46	7314150356256	1	513
NSB228-50	7314150356263	1	513
NSB228-55	7314150356270	1	513
NSB228-60	7314150356287	1	513
NSB228-65	7314150356294	1	513
NSB228-70	7314150356300	1	513
NSB228-75	7314150356317	1	513
NSB228-80	7314150356324	1	513
NSB232-16-24	7314150356379	1	513
NSB232-24-16	7314150356393	1	513
NSB232-24-32	7314150356386	1	513
NSB232-32-24	7314150356409	1	513
NSB234-16-100	7314150356461	1	513
NSB234-16-200	7314150356478	1	513
NSB234-16-250	7314150356485	1	513
NSB234-24-200	7314150356492	1	513
NSB234-32-250	7314150356508	1	513
NSB236-16	7314150356553	1	514
NSB236-24	7314150356546	1	514
NSB236-32	7314150356560	1	514
NSB238-16-250	7314150356621	1	514
NSB238-24-250	7314150356614	1	514
NSB238-32-300	7314150356607	1	514
NSB240-16-230	7314150356744	1	514
NSB242-16	7314150356669	1	514
NSB242-24	7314150356676	1	514
NSB242-32	7314150356683	1	514
NSB243-16-400	7314150356706	1	514
NSB247-26	7314150356768	1	515
NSB248-16-52	7314150356720	1	515
NSB300-10-200	7314150317646	1	515
NSB300-10-300	7314150295845	1	515
NSB300-11-250	7314150317653	1	515
NSB300-11-300	7314150317660	1	515
NSB300-11-350	7314150295852	1	515
NSB300-12-400	7314150295869	1	515
NSB300-13-450	7314150295876	1	515
NSB300-3-50	7314150317530	1	515
NSB300-3-75	7314150317547	1	515
NSB300-4-75	7314150317554	1	515
NSB300-4.5-100	7314150295838	1	515
NSB300-4.5-50	7314150317561	1	515
NSB300-5-100	7314150317585	1	515
NSB300-5-75	7314150317578	1	515
NSB300-6-100	7314150285327	1	515



NSB300-6-125	7314150317592	1	515
NSB300-6-150	7314150317608	1	515
NSB300-7-150	7314150317615	1	515
NSB300-8-150	7314150285334	1	515
NSB300-8-200	7314150317622	1	515
NSB300-9-250	7314150317639	1	515
NSB301-10-200	7314150317974	1	516
NSB301-10-300	7314150317981	1	516
NSB301-3-50	7314150317905	1	516
NSB301-4-100	7314150317912	1	516
NSB301-4-150	7314150317929	1	516
NSB301-5-100	7314150317936	1	516
NSB301-5-200	7314150317943	1	516
NSB301-6-100	7314150317950	1	516
NSB301-8-150	7314150317967	1	516
NSB302-0-50	7314150295883	1	516
NSB302-1-100	7314150285341	1	516
NSB302-2-125	7314150285358	1	516
NSB302-3-150	7314150295890	1	516
NSB302-4-300	7314150295906	1	516
NSB304-0-50	7314150295913	1	516
NSB304-1-100	7314150295920	1	516
NSB304-2-125	7314150295937	1	516
NSB304-3-150	7314150295944	1	516
NSB304-4-300	7314150295951	1	516
NSB320-10	7314150318070	1	516
NSB320-2	7314150317998	1	516
NSB320-3	7314150318001	1	516
NSB320-4	7314150318018	1	516
NSB320-5	7314150318025	1	516
NSB320-6	7314150318032	1	516
NSB320-7	7314150318049	1	516
NSB320-8	7314150318056	1	516
NSB320-9	7314150318063	1	516
NSB400-160	7314150295968	1	516
NSB400-180	7314150285365	1	516
NSB400-200	7314150295975	1	516
NSB402-160	7314150295982	1	517
NSB402-200	7314150285372	1	517
NSB403-160	7314150318179	1	517
NSB403-180	7314150318186	1	517
NSB404-160	7314150318223	1	517
NSB405-160	7314150318230	1	517
NSB406-160	7314150295999	1	517
NSB406-180	7314150318254	1	517
NSB406-200	7314150296002	1	517
NSB407-160	7314150318285	1	518
NSB408-250	7314150285389	1	518
NSB408-300	7314150318308	1	518
NSB411-200	7314150318315	1	518
NSB412-200	7314150318346	1	518
NSB413-180	7314150318353	1	518
NSB413-200	7314150318360	1	518
NSB500-1000-FB	7314150324828	1	519
NSB500-1500-FB	7314150324835	1	519
NSB500-2000	7314150324781	1	518
NSB500-2000-FB	7314150324842	1	519
NSB500-2500	7314150324798	1	518
NSB500-2500-FB	7314150324859	1	519
NSB500-3000	7314150324804	1	518
NSB500-3000-FB	7314150324866	1	519
NSB500-3500-FB	7314150324873	1	519
NSB500-4000	7314150324811	1	518
NSB502-1000-FB	7314150316922	1	519
NSB502-10000-FB	7314150316991	1	519
NSB502-12000-FB	7314150318414	1	519
NSB502-1500-FB	7314150318421	1	519
NSB502-2000-FB	7314150316939	1	519
NSB502-2500-FB	7314150316946	1	519
NSB502-3000-FB	7314150316953	1	519
NSB502-450-FB	7314150324880	1	519
NSB502-4500-FB	7314150316960	1	519
NSB502-5000-FB	7314150316977	1	519
NSB502-6800-FB	7314150318452	1	519
NSB502-8000-FB	7314150316984	1	519
NSB504-100-FB	7314150317004	1	519
NSB504-1000-FB	7314150317059	1	519
NSB504-1500-FB	7314150317066	1	519
NSB504-200-FB	7314150317011	1	519
NSB504-2000-FB	7314150317073	1	519
NSB504-300-FB	7314150317028	1	519
NSB504-500-FB	7314150317035	1	519
NSB504-800-FB	7314150317042	1	519
NSB506-300	7314150324897	1	519
NSB506-300-FB	7314150318490	1	520
NSB506-450	7314150324903	1	519
NSB506-450-FB	7314150318483	1	520
NSB506-700	7314150324910	1	519
NSB506-700-FB	7314150317080	1	520
NSB506-900	7314150324927	1	519
NSB506-900-FB	7314150317097	1	520
NSB508-500-FB	7314150318513	1	520
NSB508-700-FB	7314150318520	1	520
NSB512-200-FB	7314150318643	1	520
NSB512-400-FB	7314150318636	1	520
NSB512-600-FB	7314150318629	1	520



NSB512-900-FB	7314150318605	1	520
NSB600-100-50	7314150317110	1	520
NSB600-135-50	7314150317127	1	520
NSB600-150-25	7314150317134	1	520
NSB600-150-30	7314150317141	1	520
NSB600-150-40	7314150317158	1	520
NSB600-150-50	7314150317165	1	520
NSB600-180-13	7314150317172	1	520
NSB600-180-32	7314150317189	1	520
NSB600-180-50	7314150317196	1	520
NSB600-200-20	7314150317202	1	520
NSB600-200-30	7314150317219	1	520
NSB600-200-40	7314150317226	1	520
NSB600-200-50	7314150317233	1	520
NSB600-230-40	7314150317240	1	520
NSB600-250-40	7314150317257	1	520
NSB600-300-50	7314150317264	1	520
NSB600-80-13	7314150317103	1	520
NSB602-460	7314150324934	1	521
NSB602-600	7314150324941	1	521
NSB602-760	7314150324958	1	521
NSB602-900	7314150324965	1	521
NSB604-150	7314150324972	1	521
NSB604-200	7314150324989	1	521
NSB604-300	7314150324996	1	521
NSB606-150	7314150325009	1	521
NSB606-200	7314150325016	1	521
NSB606-250	7314150325023	1	521
NSB606-300	7314150325030	1	521
NSB606-400	7314150325047	1	521
NSB608-100	7314150325054	1	521
NSB700-300	7314150296255	1	522
NSB702-200	7314150296262	1	522
NSB704-225	7314150296279	1	522
NSB706-50	7314150296286	1	522
NSB706-80	7314150296293	1	522
NSB708-360	7314150296309	1	522
NSB710-450	7314150296316	1	523
NSB800-1100	7314150325061	1	523
NSB800-1700	7314150325078	1	523
NSB800-2000	7314150325085	1	523
NSB802-290	7314150325092	1	523
NSB810-100	7314150318650	1	523
NSB810-150	7314150318667	1	523
NSB810-200	7314150318674	1	523
NSB810-350	7314150318681	1	523
P-HB	7314150125272	25	542
P-MEC	7314150374342	24	543
P-MEC-LEAD	7314150374359	12	543
P1-20	7311518044572	5	621
P1-23	7311518332501	5	621
P108-20-F	7311518275518	2	621
P108-23-F	7311518275525	2	621
P11	7311518009076	6	632
P110-20-F	7311518275532	2	621
P110-23-F	7311518275549	2	621
P114-SL-40	7311518301149	2	624
P114-SL-50	7311518301156	2	624
P114-SL-60	7311518301163	2	624
P116-SL-40	7311518301101	2	625
P116-SL-50	7311518301118	2	625
P116-SL-60	7311518301125	2	625
P116-SL-70	7311518301132	2	625
P121-18-F	7311518275662	6	622
P121-20-F	7311518275631	6	622
P121-23-F	7311518275648	6	622
P123-19-BULK30	7311518218218	30	624
P126-19-F	7311518275297	6	622
P126-22-F	7311518275303	6	622
P127-19-BULK30	7311518199333	30	624
P128-19	7311518160814	6	624
P128-19-BULK30	7311518172329	30	624
P129-19-BULK30	7311518172336	30	624
P130-F	7311518333980	6	625
P138-22-BULK6	7311518328696	6	622
P138-22-F	7311518301279	6	622
P140-F	7311518275372	6	625
P16-40	7311518013479	2	624
P16-40W	7311518043049	2	624
P16-50-F	7311518301286	2	624
P16-60-F	7311518276461	2	624
P160-SL-60	7311518301170	2	625
P160-SL-75	7311518301187	1	625
P160-SL-90	7311518301194	1	625
P173-SL-85	7311518334703	1	625
P19-80-F	7311518275365	1	625
P20	7311518009281	6	632
P241	7311518008956	5	617
P262	7311518299286	10	616
P263	7311518299262	10	616
P264	7311518299279	10	616
P266	7311518299293	10	617
P267	7311518299309	10	616
P268	7311518299316	10	616
P269	7311518299323	10	617
P270	7311518299330	10	617





P272	7311518299354	5	616
P274	7311518299347	5	616
P276	7311518299361	5	617
P277	7311518299378	5	616
P278	7311518299385	5	616
P280-SL-60	7311518346508	2	625
P280-SL-80	7311518301330	2	625
P3-20-F	7311518275259	2	621
P3-23-F	7311518275266	2	621
P34-27A-F	7311518275464	2	627
P34-37	7311518002787	2	627
P5-23-F	7311518275280	2	621
P51-F	7311518275426	2	630
P51-SL	7311518301217	2	630
P51H-SL	7311518301224	2	630
P52-SL-20	7311518347307	2	631
P54-SL-25	7311518301231	2	631
P54H-SL-25	7311518301255	2	631
P57-25-F	7311518301293	4	630
P59-25-F	7311518275655	6	631
P6160	7314150115075	10	647
P64-20-BULK12	7311518288204	12	622
P74	7311518124076	40	632
P75	7311518124083	48	632
PAGS-2.0	7311518327835	1	601
PAGS-2.0-900FG	7311518292355	1	601
PBB-8	7314150399376	8	542
PBS-700	7314150341689	6	542
PC-10-DTF	7311518263560	10	566
PC-10-DTL	7311518263553	10	566
PC-10-DTR	7311518263546	10	566
PC-11-19-PS	7311518285548	4	565
PC-11-19-PS-B	7311518285555	10	565
PC-12-14-PS	7311518285562	4	565
PC-12-14-PS-B	7311518285579	10	565
PC-12-COM	7311518263454	4	560
PC-12-TEN	7311518263447	4	564
PC-12-VEN	7311518263430	4	564
PC-15-GNP	7311518264307	4	560
PC-15-TBX	7311518263423	4	564
PC-16-DECO	7311518264987	4	561
PC-16-FILE-U7	7311518263461	4	562
PC-19-FILE-U7	7311518263478	4	562
PC-19-GT7	7311518263362	4	562
PC-19-GT9	7311518263379	4	564
PC-20-LAM	7311518258290	4	563
PC-20-PRC	7311518264291	4	564
PC-22-FILE-U7	7311518263485	4	562
PC-22-GT7	7311518263393	4	562
PC-22-GT9	7311518263409	4	564
PC-22-INS	7314150154500	4	561
PC-22-PLC	7314150276318	4	560
PC-24-FILE-U7	7311518263492	4	562
PC-24-PLS	7311518263508	4	560
PC-24-TIM	7311518263515	4	565
PC-6-DRY	7311518282004	6	560
PC-9-9/17-PS	7311518285586	4	565
PC-9-9/17-PS-B	7311518285593	10	565
PENCIL-200-DISP	7314150125227	1	543
PG-01-F	7311518329334	6	622
PG-03-L	7311518242855	2	622
PG-12-BULK15	7311518334628	15	622
PG-12-F	7311518328122	10	622
PG-18-45-F	7311518299033	2	625
PG-18-60-F	7311518288853	2	625
PG-19-F	7311518295936	2	625
PG-56-F	7311518288938	2	631
PG-57-F	7311518295943	2	631
PG-72	7311518242534	4	634
PH-6604-1P	7311518152819	15	35
PH-6604-25	7311518141134	25	35
PS501-1	7314150338283	1	654
PS501-2	7314150112432	1	654
PS501-3	7314150338290	1	654
PS501-4	7314150338306	1	654
PU-14	7314150016266	5	44
PU-20	7314150016389	3	44
PU-22	7314150016426	3	44
PU-24	7314150016464	3	44
PU-6	7314150016105	5	44
PU-9	7314150016167	5	44
PX-L2	7311518233853	2	620
PX-L3	7311518233860	2	620
PX-M1	7311518233815	2	620
PX-M2	7311518233822	2	620
PX-M2-L	7311518240714	2	620
PX-M3	7311518233839	2	620
PX-S1	7311518233785	2	620
PX-S2	7311518233792	2	620
PXR-L2	7311518233914	2	620
PXR-M1	7311518233877	2	620
PXR-M2	7311518233884	2	620
PXR-M2-L	7311518240738	2	620
PXR-M3	7311518233891	2	620
PXR-S1	7311518240677	2	620
PXR-S2	7311518240684	2	620



PXR-S2-L	7311518346799	2	620
QC-115A	7314150460007	12	588
QC-115A-2P	7314150460021	6	588
QC-150A	7314150460045	6	588
QC-150A-2P	7314150460069	6	588
QC-300A	7314150401925	6	588
QC-300A-2P	7314150460090	4	588
QCB-1250	7314150135981	8	588
QCB-150	7314150135912	6	588
QCB-300	7314150135936	6	588
QCB-450	7314150135950	6	588
QCB-600	7314150135967	4	588
QCB-900	7314150135974	4	588
QCG-150	7314150135899	6	588
QCG-300	7314150135905	6	588
R1068	7311518044398	1	623
R1069P	7311518219574	12	623
R1071	7311518222918	14	624
R1075-BULK50	7311518220495	50	624
R1080P	7311518282479	1	623
R112PG	7311518010058	1	622
R113PG	7311518044374	30	623
R114PG	7311518010065	1	622
R114V	7311518042660	25	625
R114V-BULK28	7311518177539	28	625
R115V	7311518243210	8	625
R115V-BULK14	7311518288341	14	625
R116V	7311518010164	1	625
R116V-BULK36	7311518159924	36	625
R119V	7311518029487	1	625
R122PG	7311518010072	30	622
R123PG	7311518044381	30	623
R124PG	7311518010089	30	622
R1269P-BULK50	7311518240820	50	621
R133PG	7311518328252	1	629
R137E	7311518011574	30	628
R142P	7311518010126	24	623
R143PV	7311518010133	1	626
R143PVCB	7311518255633	1	626
R144PV	7311518291075	24	626
R146VC	7311518046545	22	631
R146VS	7311518046538	24	626
R146VS-BULK50	7311518159955	50	626
R147V	7311518044909	24	631
R148V	7311518223922	1	623
R1601	7311518044640	1	623
R160A	7311518201821	1	625
R160A-BULK28	7311518337216	28	625
R166V	7311518328085	22	626
R16V	7311518254513	1	625
R16V-BULK14	7311518288334	14	625
R181P	7311518296087	1	625
R185V	7311518331795	25	625
R201P	7311518219536	1	622
R201P-BULK80	7311518225209	80	622
R202P	7311518219550	1	623
R211P	7311518234027	1	620
R211P-BULK80	7311518252212	80	620
R214SL	7311518301392	1	626
R214V	7311518042745	1	622
R214V-BULK28	7311518177553	28	626
R215V	7311518243227	1	626
R216SL	7311518301408	8	626
R221P	7311518229412	1	622
R221P-BULK50	7311518240653	50	622
R223P	7311518237554	1	622
R223P-BULK80	7311518240646	80	622
R230P	7311518341503	10	628
R239P	7311518219567	1	623
R260A	7311518201814	16	626
R272H	7311518258016	1	626
R300P	7311518234034	1	620
R303P	7311518234157	1	620
R310-0	7314151829797	1	56
R310-1	7314151829803	1	56
R310-2	7314151829810	1	56
R310-3	7314151829827	1	56
R312V	7311518235420	1	626
R315V	7311518243234	1	626
R318V	7311518029500	1	626
R328V	7311518296056	22	626
R335V	7311518331801	12	626
R337E	7311518011598	1	629
R341P	7311518011529	12	623
R372H	7311518235406	1	626
R373A	7311518334710	25	625
R403P	7311518234164	1	620
R415V	7311518243241	1	626
R4230	7311518341510	10	628
R427AE	7311518176068	18	629
R434P	7311518223885	1	623
R434P-BULK50	7311518169916	50	623
R437E	7311518011611	18	629
R438P	7311518229429	1	623
R438P-BULK50	7311518240660	50	623
R440V	7311518254544	22	626



R444V	7311518243340	22	631
R463P	7311518223908	1	623
R472H	7311518334840	30	626
R474P	7311518011536	1	623
R478P	7311518275600	1	624
R480P	7311518282486	1	624
R500P	7311518234041	40	620
R503P	7311518234171	1	620
R515VS	7311518046514	22	631
R516V	7311518200824	22	631
R519V	7311518029517	1	626
R600P	7311518240783	1	620
R603P	7311518240790	1	620
R615V	7311518010119	1	626
R619V	7311518029494	1	626
R660V	7311518210281	24	626
R6725MK	7314151088354	1	69
R6725ZK	7314151784898	1	69
R680V	7311518042752	1	626
R6810M-10	7314150195152	5	78
R6810M-3,4	7314150195077	5	78
R6810M-4	7314150195084	5	78
R6810M-4,5	7314150195091	5	78
R6810M-5	7314150195107	5	78
R6810M-6	7314150195114	5	78
R6810M-7	7314150195121	1	78
R6810M-8	7314150195138	5	78
R6810M-9	7314150195145	5	78
R6810Z-1/4	7314150429448	1	79
R6810Z-3/16	7314150429387	1	79
R6810Z-3/8	7314150429394	1	79
R6810Z-5/16	7314150429400	1	79
R6810Z-7/32	7314150429417	1	79
R6822Z	7314150429424	5	79
R6950	7314151089658	1	84
R6964A	7314150195176	1	79
R6967	7314150195169	5	79
R716VCB	7311518255497	40	626
R772V	7311518301385	14	626
R773V	7311518324414	1	626
R775V	7311518331818	1	626
R776V	7311518334734	1	626
R801P	7311518234126	1	620
R802P	7311518234133	1	620
R803P	7311518234140	1	620
R804P	7311518240806	1	620
R811P	7311518234058	1	620
R812P	7311518234065	1	620
R813P	7311518234072	1	620
R815P	7311518240752	1	620
R900P	7311518234188	1	620
R901P	7311518234195	30	620
R902P	7311518234201	24	621
R903P	7311518234218	1	621
R904P	7311518234225	1	621
R905P	7311518234232	1	621
R905P-BULK50	7311518252250	50	621
R906P	7311518234249	1	621
R906P-BULK50	7311518252267	50	621
R907P	7311518234256	1	621
RAIL-10	7314150511075	10	82
RAIL-340	7314153003645	3	82
RAIL-8	7314150511051	10	82
RAUNI	7311518339289	6	627
RB-SET-AL06-5P	7314150501489	1	148
RB-SET-M06X-10P	7314150501557	1	148
RB-SET1-M06X-5P	7314150501588	1	148
RB-SET2-M06X-5P	7314150501618	1	148
RBCP	7311518339272	10	628
RBCP230	7311518341558	12	628
RCAM30	7311518346959	20	628
RCAM36	7311518346973	20	628
RD1M	7311518341534	15	628
RD7M	7311518341541	20	629
RPL230G	7311518341527	8	629
RT821P	7311518242237	1	620
RT822P	7311518234102	1	620
RT823P	7311518234119	6	620
RT824P	7311518240776	1	620
RT825P	7311518347147	6	620
RX 01	7314150103263	1	649
RX 7390	7314150342587	10	651
RX 7392	7314150342594	10	651
RX 7490	7314150103195	10	650
RX 7590	7314150103201	10	650
RX 7890	7314150103218	10	651
RX 7891	7314150103225	10	651
RX 7892	7314150103232	10	651
RX 7893	7314150103249	10	651
RX 7894	7314150212101	10	652
RX 8130	7314150103003	10	644
RX 8131	7314150103010	10	644
RX 8132	7314150103027	10	644
RX 8137	7314150392926	10	645
RX 8140	7314150103034	10	644



RX 8141	7314150103041	10	644
RX 8142	7314150103058	10	644
RX 8142PS	7314150349371	10	649
RX 8143	7314150103065	10	644
RX 8144	7314150103072	10	644
RX 8145	7314150103089	10	644
RX 8146	7314150103096	10	645
RX 8147	7314150103102	10	645
RX 8147PS	7314150425402	10	649
RX 8148	7314150103119	10	645
RX 8149	7314150103126	10	648
RX 8150	7314150103133	10	644
RX 8151	7314150103140	10	644
RX 8152	7314150103157	10	644
RX 8153	7314150412976	10	644
RX 8154	7314150351435	10	644
RX 8156	7314150411528	10	645
RX 8157	7314150383733	10	645
RX 8158	7314150117130	10	644
RX 8160	7314150111534	10	645
RX 8161	7314150111541	10	644
RX 8161PS	7314150410750	10	649
RX 8162	7314150111558	10	644
RX 8164	7314150116270	10	644
RX 8165	7314150116287	10	644
RX 8167	7314150383726	10	645
RX 8168	7314150115495	10	645
RX 8211	7314150103188	10	646
RX 8247	7314150103164	10	646
RX 8248	7314150103171	10	647
RX112A-0.3	7314150411498	5	653
RX112A-1.0	7314150384020	10	653
RX112A-1.5	7314150352425	10	653
RX112A-2.0	7314150384037	10	653
RX304D	7314150476701	5	653
RX331A	7314150434725	10	653
RX8133	7314150476749	10	644
RX8134	7314150476756	10	644
RX8135	7314150476763	10	644
RX8136	7314150476770	10	645
RX8137MX	7314150358519	10	645
RX8138	7314150346561	10	645
RX8138MX	7314150349395	10	645
RX8140M2	7314150476787	10	649
RX8140PS	7314150360635	10	649
RX8141PS	7314150349432	10	649
RX8143PS	7314150360642	10	649
RX8150M2	7314150476794	10	649
RX8150PS	7314150358502	10	649
RX8155	7314150374014	10	644
RX8160BPS	7314150360048	10	650
RX8160M2	7314150476800	10	649
RX8163	7314150476817	10	644
RX8166	7314150476558	10	645
RX8233A	7314150436279	10	648
RX8234A	7314150436286	10	648
RX8237A	7314150436293	10	648
S0810L	7314150256594	20	63
S103	7314150257119	2	62
S103-CASE	7314150321261	1	102
S106	7314150103997	2	62
S108	7314150122257	2	62
S108-CASE	7314150349319	1	102
S1214L	7314150256600	10	69
S137	7314150450503	2	63
S138	7314150195022	2	63
S140T	7314150125203	1	70
S140T-R	7314150136353	10	70
S160	7314150104031	6	64
S160AF	7314150137510	6	64
S1612L	7314150256617	4	72
S18HEX	7314150412457	4	72
S18TORX	7314150412464	4	72
S240	7314150104017	4	72
S240AF	7314150111077	4	72
S240AF-CASE	7314150187317	1	102
S290	7314153000859	6	64
S330	7314150104024	6	69
S330-CASE	7314150136223	1	102
S330AF	7314150137503	6	70
S330L	7314150256587	4	69
S330L-CASE	7311518337674	1	102
S350AF	7314150137527	2	73
S380	7314150168934	4	70
S400	7314150111053	2	72
S400-CASE	7314150187300	1	102
S410	7314153019370	2	62
S410-CASE	7314150321223	1	102
S460	7314150111060	6	64
S460-CASE	7314150321209	1	102
S4RM-12-15	7314150179954	1	47
S4RM-16-19	7314150179961	1	47
S4RM-21-27	7314150179978	1	47
S4RM-30-36	7314150179985	1	47
S4RM-4-7	7314150179930	1	47
S4RM-8-11	7314150179947	1	47



S4RM/3T



S4RM/3T	7314150117406	20	47
S4RM/4T	7314150179916	1	48
S4RM/5T	7314150179923	1	48
S530T	7314150169122	4	70
S560	7314150122264	4	63
S560-CASE	7314150321216	1	102
S800	7314150165599	2	62
S81MIX	7314150180127	2	62
S81MIX-CASE	7314150321247	1	102
S87+7	7314150103980	2	62
S910	7314150104000	2	62
S910AF	7314150137541	2	63
S95	7314150409167	2	62
S9HEX	7314150412433	10	72
S9TORX	7314150412440	10	72
SB-2058/S26	7314151849498	1	168
SB-2448	7314150136056	12	572
SB-2449	7314150194049	10	572
SB-3732-2-125	7314151847869	60	608
SB-3732-2.5-125	7314151847876	60	608
SB-3732-3.2-125	7314151847883	60	608
SB-3732-4-125	7314151847890	1	608
SB-3734N-10-150	7314151848101	1	607
SB-3734N-2-150	7314151847968	1	607
SB-3734N-3-150	7314151847975	1	607
SB-3734N-4-150	7314151847982	60	607
SB-3734N-5-150	7314151847999	1	607
SB-3734N-6-150	7314151848071	60	607
SB-3734N-7-150	7314151848088	1	607
SB-3734N-8-150	7314151848095	1	607
SB-3735N-2-100	7314151847906	1	606
SB-3735N-4-120	7314151847913	60	606
SB-3735N-5-120	7314151847920	1	606
SB-3735N-6-150	7314151847937	1	606
SB-3735N-8-150	7314151847944	1	606
SB-3740-125	7314150115990	87	604
SB-3740-150	7314150116003	25	604
SB-3740-175	7314150116010	25	604
SB-3740-200	7314150116027	25	604
SB-3740-250	7314150116034	25	604
SB-3740-300	7314150116041	25	604
SB-9526/S6	7314150154234	20	154
SB111M-10	7314151839864	1	40
SB111M-11	7314151839871	1	40
SB111M-12	7314151839888	1	40
SB111M-13	7314151839895	1	40
SB111M-14	7314151839901	1	40
SB111M-15	7314151839918	1	40
SB111M-16	7314151839925	1	41
SB111M-17	7314151839932	1	41
SB111M-18	7314151839949	1	41
SB111M-19	7314151839956	1	41
SB111M-20	7314151839963	1	41
SB111M-21	7314151839970	1	41
SB111M-22	7314151839987	1	41
SB111M-23	7314151839994	1	41
SB111M-24	7314151840006	1	41
SB111M-25	7314151840013	1	41
SB111M-26	7314151840020	1	41
SB111M-27	7314151840037	1	41
SB111M-28	7314150432103	1	41
SB111M-29	7314151840051	1	41
SB111M-30	7314151840068	1	41
SB111M-32	7314151840075	1	41
SB111M-5.5	7314151839819	1	40
SB111M-6	7314151839826	1	40
SB111M-7	7314151839833	1	40
SB111M-8	7314151839840	1	40
SB111M-9	7314151839857	1	40
SB141.007.075	7314150282753	1	206
SB141.008.075	7314150282760	1	206
SB141.009.075	7314150282777	1	206
SB141.010.075	7314150282784	1	206
SB141.015.100	7314150282791	1	206
SB141.020.100	7314150282807	1	206
SB141.025.125	7314150282814	1	206
SB141.027.125	7314150282821	1	206
SB141.030.150	7314150282838	1	206
SB141.040.150	7314150282845	1	206
SB142.000.075	7314150282579	1	496
SB142.001.080	7314150282586	1	496
SB142.002.100	7314150282593	1	496
SB142.003.150	7314150282609	1	496
SB143.020.100	7314150282852	1	496
SB143.025.100	7314150282869	1	206
SB143.030.100	7314150282876	1	206
SB143.040.100	7314150282883	1	206
SB143.050.100	7314150282890	1	206
SB143.060.125	7314150282906	1	206
SB143.080.150	7314150282913	1	206
SB144.001.100	7314150282951	1	206
SB144.002.125	7314150282968	1	206
SB144.003.150	7314150282975	1	206
SB145.006.100	7314150282920	1	207
SB146.006.100	7314150282937	1	207
SB148.001.080	7314150314577	1	496



SB148.002.100	7314150314584	1	496
SB149.001.080	7314150314591	1	496
SB149.002.100	7314150314607	1	496
SB150.010.100	7314150343492	1	496
SB150.015.125	7314150343515	1	496
SB150.020.125	7314150343577	1	496
SB150.025.150	7314150343584	1	496
SB190.040.075	7314150281985	1	204
SB190.040.100	7314150282098	1	204
SB190.055.100	7314150281992	1	204
SB190.055.125	7314150282005	1	204
SB190.065.125	7314150282012	1	204
SB190.065.150	7314150282029	1	204
SB190.080.150	7314150282036	1	204
SB190.080.175	7314150282043	1	204
SB190.100.200	7314150282050	1	204
SB190.120.250	7314150282067	1	204
SB190.140.250	7314150282074	1	204
SB191.025.075	7314150282081	1	204
SB191.030.075	7314150282104	1	204
SB191.030.100	7314150282111	1	204
SB191.030.200	7314150282128	1	204
SB191.035.100	7314150282135	1	204
SB191.040.100	7314150282142	1	204
SB191.040.125	7314150282159	1	204
SB191.040.250	7314150282166	1	204
SB191.055.125	7314150282173	1	204
SB191.055.150	7314150282180	1	204
SB191.055.300	7314150282197	1	204
SB191.065.150	7314150282203	1	204
SB191.065.300	7314150282210	1	204
SB192.000.075	7314150282357	1	205
SB192.000.200	7314150282364	1	205
SB192.001.100	7314150282371	1	205
SB192.001.250	7314150282388	1	205
SB192.002.125	7314150282395	1	205
SB192.002.300	7314150282401	1	205
SB192.003.150	7314150282418	1	205
SB192.004.200	7314150282425	1	205
SB193.000.075	7314150282456	1	205
SB193.001.100	7314150282463	1	205
SB193.002.125	7314150282470	1	205
SB193.003.150	7314150282487	1	205
SB193.004.200	7314150282494	1	205
SB194.004.075	7314150282616	1	206
SB194.005.075	7314150282623	1	206
SB194.006.075	7314150282630	1	206
SB194.007.075	7314150282647	1	206
SB194.008.075	7314150282654	1	206
SB194.009.075	7314150282661	1	206
SB194.010.075	7314150282678	1	206
SB194.015.100	7314150282685	1	206
SB194.020.100	7314150282692	1	206
SB194.025.125	7314150282708	1	206
SB194.027.125	7314150282715	1	206
SB194.030.150	7314150282722	1	206
SB194.040.150	7314150282739	1	206
SB194.045.150	7314150282746	1	206
SB195.001.025	7314150282432	1	205
SB195.002.025	7314150282449	1	205
SB195.006.050	7314150289516	1	207
SB195.040.025	7314150282227	1	204
SB195.050.025	7314150282234	1	204
SB195.060.025	7314150282241	1	204
SB195.901.025	7314150282500	1	205
SB195.902.025	7314150282517	1	205
SB1952M-10	7314150105205	1	43
SB1952M-12	7314150105229	1	43
SB1952M-13	7314150105236	1	43
SB1952M-14	7314150105243	1	43
SB1952M-17	7314150105274	1	43
SB1952M-19	7314150105298	1	43
SB1952M-24	7314150105342	1	43
SB1952M-7	7314150105441	1	43
SB1952M-8	7314150105458	1	43
SB196.025.075	7314150282258	1	495
SB196.030.100	7314150282265	1	495
SB196.035.100	7314150282272	1	495
SB196.040.100	7314150282289	1	495
SB196.055.125	7314150282296	1	495
SB196.065.150	7314150282302	1	495
SB196.080.175	7314150282326	1	495
SB196.100.200	7314150282333	1	495
SB196.120.200	7314150282340	1	495
SB197.000.075	7314150282524	1	496
SB197.001.080	7314150282531	1	496
SB197.002.100	7314150282548	1	496
SB197.003.150	7314150282555	1	496
SB197.004.200	7314150282562	1	496
SB198.040.125	7314150282982	1	207
SB198.045.125	7314150282999	1	207
SB198.050.150	7314150283002	1	207
SB198.055.150	7314150283019	1	207
SB198.060.150	7314150283026	1	207
SB198.060.150F	7314150283033	1	207
SB198.070.150	7314150283040	1	207

SB198.070.150F	7314150283057	1	207
SB198.080.150	7314150283064	1	207
SB198.080.150F	7314150283071	1	207
SB198.090.150	7314150283088	1	207
SB198.100.150	7314150283095	1	207
SB198.110.150	7314150283101	1	207
SB198.120.150	7314150283118	1	207
SB198.130.150	7314150283125	1	207
SB198.140.150	7314150283132	1	207
SB199.055.125	7314150283149	1	496
SB199.060.125	7314150283156	1	496
SB199.070.125	7314150283163	1	496
SB199.080.125	7314150283170	1	496
SB199.090.125	7314150283187	1	496
SB199.100.125	7314150283194	1	496
SB199.110.125	7314150283200	1	496
SB199.120.125	7314150287765	1	496
SB199.130.125	7314150287796	1	496
SB2446-EL	7314150312207	10	584
SB2446-LAP	7314150539475	10	583
SB27M-10-11	7314150180851	10	58
SB27M-12-13	7314150180868	10	58
SB27M-14-15	7314150180875	10	58
SB27M-16-17	7314150180882	10	58
SB27M-18-19	7314150180899	10	58
SB27M-20-22	7314150180905	10	58
SB27M-21-23	7314150180912	5	58
SB27M-24-26	7314150180929	5	58
SB27M-6-7	7314150180837	10	58
SB27M-8-9	7314150180844	10	58
SB28M-10	7314150485987	10	56
SB28M-11	7314150486007	10	56
SB28M-12	7314150486021	10	56
SB28M-13	7314150486045	10	56
SB28M-14	7314150486052	10	56
SB28M-15	7314150486076	10	56
SB28M-16	7314150486090	5	56
SB28M-17	7314150486113	5	56
SB28M-18	7314150486137	5	56
SB28M-19	7314150486151	5	56
SB28M-20	7314150486854	4	56
SB28M-21	7314150486878	4	56
SB28M-22	7314150486892	4	56
SB28M-23	7314150486915	4	56
SB28M-24	7314150486939	4	56
SB28M-6	7314150486175	10	56
SB28M-7	7314150486199	10	56
SB28M-8	7314150486212	10	56
SB28M-9	7314150486236	10	56
SB3654BM-15	7314150270897	5	610
SB3654BM-20	7314150270903	5	610
SB3734BM-10	7314150271092	5	610
SB3734BM-3	7314150270996	5	610
SB3734BM-4	7314150271016	5	610
SB3734BM-5	7314150271030	5	610
SB3734BM-6	7314150271054	5	610
SB3734BM-8	7314150271078	5	610
SB3755BM-4	7314150270934	1	610
SB3755BM-6	7314150270958	5	610
SB6700SM-10	7314150104383	1	78
SB6700SM-11	7314150104390	1	78
SB6700SM-12	7314150104406	1	78
SB6700SM-13	7314150104413	1	78
SB6700SM-14	7314150104420	1	78
SB6700SM-4	7314150104307	1	78
SB6700SM-4.5	7314150104314	1	78
SB6700SM-5	7314150104321	1	78
SB6700SM-5.5	7314150104338	1	78
SB6700SM-6	7314150104345	1	78
SB6700SM-7	7314150104352	1	78
SB6700SM-8	7314150104369	1	78
SB6700SM-9	7314150104376	1	78
SB6700SZ-1/2	7314150240609	1	78
SB6700SZ-1/4	7314150240616	1	78
SB6700SZ-1/8	7314150412495	5	78
SB6700SZ-11/32	7314150240623	1	78
SB6700SZ-3/16	7314150240630	1	78
SB6700SZ-3/8	7314150240647	1	78
SB6700SZ-5/16	7314150240654	1	78
SB6700SZ-5/32	7314150240661	1	78
SB6700SZ-7/16	7314150240678	1	78
SB6700SZ-7/32	7314150240685	1	78
SB6700SZ-9/16	7314150240692	1	78
SB6700SZ-9/32	7314150240708	1	78
SB6700TORX-E10	7314150240715	1	78
SB6700TORX-E4	7314150240722	1	78
SB6700TORX-E5	7314150240739	1	78
SB6700TORX-E6	7314150240746	1	78
SB6700TORX-E7	7314150240753	1	78
SB6700TORX-E8	7314150240760	1	78
SB6709F-4.5	7314150240777	1	82
SB6709F-5.5	7314150240784	1	82
SB6709F-6.5	7314150240791	1	82
SB6709F-8	7314150240807	1	82
SB67M-3	7314150290055	1	83
SB6709M-4	7314150240821	1	83

SB6709M-5	7314150240838	1	83
SB6709M-6	7314150240845	1	83
SB6709M-8	7314150240852	1	83
SB6709PH-1	7314150240869	1	82
SB6709PH-2	7314150240876	1	82
SB6709PH-3	7314150240883	1	82
SB6709PZ-1	7314150240890	1	83
SB6709PZ-2	7314150240906	1	83
SB6709PZ-3	7314150240913	1	83
SB6709TORX-R-T10	7314150240975	1	83
SB6709TORX-R-T15	7314150240937	1	83
SB6709TORX-R-T20	7314150240944	1	83
SB6709TORX-R-T25	7314150240951	1	83
SB6709TORX-R-T8	7314150240968	1	83
SB6709TORX-T10	7314150240982	1	83
SB6709TORX-T15	7314150240999	1	83
SB6709TORX-T20	7314150241002	1	83
SB6709TORX-T25	7314150241019	1	83
SB6709TORX-T27	7314150241026	1	83
SB6709TORX-T30	7314150241033	1	83
SB6709TORX-T40	7314150241040	1	83
SB6709TORX-T8	7314150241057	1	83
SB6709TORX-T9	7314150241064	1	83
SB6950	7314150104987	1	84
SB6950RN	7314150104994	1	84
SB6954-5	7314150512188	10	80
SB6956	7314150241071	1	80
SB6958-6	7314150500833	1	80
SB6960	7314150104925	1	81
SB6960-3	7314150512225	1	81
SB6961	7314150104932	1	81
SB6962	7314150104949	1	81
SB6962L	7314150254743	1	81
SB6963	7314150241088	1	81
SB6966	7314150241095	1	81
SB6973A	7314150507214	1	82
SB6M-10-11	7314150105731	1	48
SB6M-12-13	7314150105762	1	48
SB6M-14-15	7314150105823	1	48
SB6M-16-17	7314150105847	1	48
SB6M-17-19	7314150189830	1	48
SB6M-18-19	7314150105878	1	48
SB6M-20-22	7314150105915	1	48
SB6M-21-23	7314150105922	1	48
SB6M-22-24	7314150105946	1	48
SB6M-24-26	7314150105953	1	48
SB6M-24-27	7314150105960	1	48
SB6M-25-28	7314150189847	1	48
SB6M-27-29	7314150189854	1	48
SB6M-30-32	7314150106011	1	48
SB6M-4-5	7314150106042	1	48
SB6M-6-7	7314150106073	1	48
SB6M-8-9	7314150106103	1	48
SB705.1/4.125	7314150283231	1	216
SB7400SM-10	7314150241101	1	85
SB7400SM-11	7314150241118	1	85
SB7400SM-12	7314150241125	1	85
SB7400SM-13	7314150241132	1	85
SB7400SM-14	7314150241149	1	85
SB7400SM-15	7314150241156	1	85
SB7400SM-16	7314150241170	1	85
SB7400SM-17	7314150241187	1	85
SB7400SM-18	7314150241194	1	85
SB7400SM-19	7314150241200	1	85
SB7400SM-20	7314150241217	1	85
SB7400SM-21	7314150241224	1	85
SB7400SM-22	7314150241231	1	85
SB7400SM-6	7314150241248	1	85
SB7400SM-7	7314150241255	1	85
SB7400SM-8	7314150241262	1	85
SB7400SM-9	7314150241279	1	85
SB7400TORX-E10	7314150241286	1	86
SB7400TORX-E11	7314150241293	1	86
SB7400TORX-E12	7314150241309	1	86
SB7400TORX-E14	7314150241316	1	86
SB7400TORX-E16	7314150241323	1	86
SB7400TORX-E18	7314150241330	1	86
SB7400TORX-E8	7314150241347	1	86
SB7409BH-10	7314150241354	1	90
SB7409BH-4	7314150241361	1	90
SB7409BH-5	7314150241378	1	90
SB7409BH-6	7314150241385	1	90
SB7409BH-8	7314150241392	1	90
SB7409F-10	7314150241408	1	89
SB7409F-6.5	7314150241415	1	89
SB7409F-8	7314150241422	1	89
SB7409M-10	7314150241439	1	90
SB7409M-3	7314150241446	1	90
SB7409M-4	7314150241453	1	90
SB7409M-5	7314150241460	1	90
SB7409M-6	7314150241477	1	90
SB7409M-7	7314150241484	1	90
SB7409M-8	7314150241491	1	90
SB7409PH-1	7314150241507	1	89
SB7409PH-2	7314150241514	1	89
SB7409PH-3	7314150241521	1	89



SB7409TORX-R-T27



SB7409TORX-R-T27	7314150241538	1	89
SB7409TORX-R-T30	7314150241545	1	89
SB7409TORX-R-T40	7314150241552	1	89
SB7409TORX-R-T45	7314150241569	1	89
SB7409TORX-R-T50	7314150241576	1	89
SB7409TORX-T20	7314150241583	1	89
SB7409TORX-T25	7314150241590	1	89
SB7409TORX-T25-L	7314150241606	1	90
SB7409TORX-T27	7314150241613	1	89
SB7409TORX-T30	7314150241620	1	89
SB7409TORX-T30-L	7314150241637	1	90
SB7409TORX-T40	7314150241644	1	89
SB7409TORX-T40-L	7314150241651	1	90
SB7409TORX-T45	7314150241668	1	89
SB7409TORX-T45-L	7314150241675	1	90
SB7409TORX-T50	7314150241682	1	89
SB7409TORX-T50-L	7314150241699	1	90
SB7750	7314150187850	1	88
SB7750RN	7314153003966	1	88
SB7754	7314150250165	1	87
SB7756	7314150489176	1	87
SB7758-10	7314150500840	1	87
SB7759	7314150254859	1	87
SB7760	7314153003980	1	87
SB7761	7314150241705	1	87
SB7762	7314153004000	1	87
SB7764	7314150241729	1	88
SB7765	7314150241736	50	81
SB7766	7314150241743	1	87
SB7767	7314150254897	1	82
SB7773A	7314150516209	1	88
SB7800DM-10	7314150104451	1	92
SB7800DM-11	7314150104468	1	92
SB7800DM-12	7314150104475	1	92
SB7800DM-13	7314150104482	1	92
SB7800DM-14	7314150104499	1	92
SB7800DM-15	7314150104505	1	92
SB7800DM-16	7314150104512	1	92
SB7800DM-17	7314150104529	1	92
SB7800DM-18	7314150104536	1	92
SB7800DM-19	7314150104543	1	92
SB7800DM-20	7314150104550	1	92
SB7800DM-21	7314150104567	1	92
SB7800DM-22	7314150104574	1	92
SB7800DM-23	7314150104581	1	92
SB7800DM-24	7314150104598	1	92
SB7800DM-25	7314150104604	1	92
SB7800DM-26	7314150104611	1	92
SB7800DM-27	7314150104628	1	92
SB7800DM-28	7314150104635	1	92
SB7800DM-29	7314150104642	1	92
SB7800DM-30	7314150104659	1	92
SB7800DM-31	7314150471171	1	92
SB7800DM-32	7314150104666	1	92
SB7800DM-33	7314150240319	1	92
SB7800DM-34	7314150327607	1	92
SB7800DM-36	7314150104673	1	92
SB7800DM-8	7314150104437	1	92
SB7800DM-9	7314150104444	1	92
SB7800DZ-1	7314150234912	1	92
SB7800DZ-1.1/16	7314150240326	1	92
SB7800DZ-1.1/4	7314150240333	1	92
SB7800DZ-1.1/8	7314150240340	1	92
SB7800DZ-1.3/16	7314150240357	1	92
SB7800DZ-1.5/16	7314150240364	1	92
SB7800DZ-1/2	7314150234899	1	92
SB7800DZ-11/16	7314150234929	1	92
SB7800DZ-13/16	7314150234936	1	92
SB7800DZ-15/16	7314150234943	1	92
SB7800DZ-19/32	7314150240371	1	92
SB7800DZ-25/32	7314150240388	1	92
SB7800DZ-3/4	7314150234950	1	92
SB7800DZ-3/8	7314150234967	1	92
SB7800DZ-5/8	7314150234974	1	92
SB7800DZ-7/16	7314150234981	1	92
SB7800DZ-7/8	7314150234998	1	92
SB7800DZ-9/16	7314150235001	1	92
SB7800SM-10	7314150104703	1	91
SB7800SM-11	7314150104710	1	91
SB7800SM-12	7314150104727	1	91
SB7800SM-13	7314150104734	1	91
SB7800SM-14	7314150104741	1	91
SB7800SM-15	7314150104758	1	91
SB7800SM-16	7314150104765	1	91
SB7800SM-17	7314150104772	1	91
SB7800SM-18	7314150104789	1	91
SB7800SM-19	7314150104796	1	91
SB7800SM-20	7314150240395	1	91
SB7800SM-21	7314150104819	1	91
SB7800SM-22	7314150104826	1	91
SB7800SM-23	7314150104833	1	91
SB7800SM-24	7314150104840	1	91
SB7800SM-25	7314150104857	1	91
SB7800SM-26	7314150104864	1	91
SB7800SM-27	7314150104871	1	91
SB7800SM-28	7314150104888	1	91



SB7800SM-29	7314150240401	1	91
SB7800SM-30	7314150104895	1	91
SB7800SM-32	7314150104901	1	91
SB7800SM-33	7314150240418	1	91
SB7800SM-34	7314150235018	1	91
SB7800SM-36	7314150235025	1	91
SB7800SM-8	7314150104680	1	91
SB7800SM-9	7314150104697	1	91
SB7800TORX-E10	7314150240104	1	93
SB7800TORX-E11	7314150240111	1	93
SB7800TORX-E12	7314150240128	1	93
SB7800TORX-E14	7314150240135	1	93
SB7800TORX-E16	7314150240142	1	93
SB7800TORX-E18	7314150240159	1	93
SB7800TORX-E20	7314150240166	1	93
SB7800TORX-E24	7314150240173	1	93
SB7800TORX-E8	7314150240180	1	93
SB7805DM-10	7314150234851	1	92
SB7805DM-12	7314150234868	1	92
SB7805DM-13	7314150235032	1	92
SB7805DM-14	7314150235049	1	92
SB7805DM-15	7314150235056	1	92
SB7805DM-16	7314150235063	1	92
SB7805DM-17	7314150235070	1	92
SB7805DM-18	7314150235087	1	92
SB7805DM-19	7314150235094	1	92
SB7805DM-21	7314150235100	1	92
SB7805DM-22	7314150235117	1	92
SB7805DM-23	7314150327614	1	92
SB7805DM-24	7314150235124	1	93
SB7805DM-26	7314150240197	1	93
SB7805DM-27	7314150235131	1	93
SB7805DM-30	7314150235148	1	93
SB7805DM-32	7314150240203	1	93
SB7805DM-34	7314150521852	1	93
SB7805SM-10	7314150235155	1	91
SB7805SM-11	7314150524501	1	91
SB7805SM-12	7314150235162	1	91
SB7805SM-13	7314150235179	1	91
SB7805SM-14	7314150235193	1	91
SB7805SM-15	7314150235216	1	91
SB7805SM-16	7314150240210	1	91
SB7805SM-17	7314150235223	1	91
SB7805SM-18	7314150235230	1	91
SB7805SM-19	7314150235247	1	91
SB7805SM-20	7314150240227	1	91
SB7805SM-21	7314150235254	1	91
SB7805SM-22	7314150235261	1	91
SB7805SM-23	7314150240234	1	91
SB7805SM-24	7314150235278	1	91
SB7805SM-25	7314150240241	1	91
SB7805SM-26	7314150240258	1	91
SB7805SM-27	7314150235285	1	91
SB7805SM-28	7314150240265	1	91
SB7805SM-29	7314150240272	1	91
SB7805SM-30	7314150235292	1	91
SB7805SM-32	7314150235308	1	91
SB7805SM-34	7314150498284	1	91
SB7807H	7314150467297	1	177
SB7808H	7314150467303	1	177
SB7809H	7314150467341	1	177
SB7809M-10	7314153004185	1	96
SB7809M-12	7314153004208	1	96
SB7809M-14	7314153004215	1	96
SB7809M-17	7314153004222	1	96
SB7809M-19	7314153004239	1	96
SB7809M-4	7314150313952	1	96
SB7809M-5	7314153004109	1	96
SB7809M-5-180	7314153004116	1	96
SB7809M-6	7314153004123	1	96
SB7809M-7	7314153004130	1	96
SB7809M-7-100	7314153004147	1	96
SB7809M-8	7314153004154	1	96
SB7809M-8-120	7314153004161	1	96
SB7809M-9	7314153004178	1	96
SB7809TORX-T20	7314153004017	1	95
SB7809TORX-T25	7314153004024	1	95
SB7809TORX-T27	7314153004031	1	95
SB7809TORX-T30	7314153004048	1	95
SB7809TORX-T40	7314153004055	1	95
SB7809TORX-T45	7314153004062	1	95
SB7809TORX-T50	7314153004079	1	95
SB7809TORX-T55	7314153004086	1	95
SB7809TORX-T60	7314153004093	1	95
SB8150-1/2	7314150105014	1	97
SB8150RN-1/2	7314150105007	1	97
SB8154-11	7314150472178	1	93
SB8157-10	7314150474073	1	93
SB8157-15	7314150472468	1	93
SB8157-24	7314150474080	1	93
SB8157-36	7314150474097	1	93
SB8158-10	7314150488780	1	93
SB8158-15	7314150488797	1	93
SB8160-10	7314150472185	1	93
SB8160-3	7314150472192	1	93
SB8160-5	7314150472208	1	93



SB8166	7314150472154	1	94
SB8171	7314150479016	1	94
SB8172	7314150479023	1	94
SBA6700DM-10	7314150235575	1	79
SBA6700DM-11	7314150241750	1	79
SBA6700DM-12	7314150241767	1	79
SBA6700DM-13	7314150241774	1	79
SBA6700DM-14	7314150241781	1	79
SBA6700DM-5	7314150255054	1	79
SBA6700DM-5.5	7314150241798	1	79
SBA6700DM-6	7314150241804	1	79
SBA6700DM-7	7314150241811	1	79
SBA6700DM-8	7314150241828	1	79
SBA6700DM-9	7314150241835	1	79
SBA6700DZ-1/2	7314150241842	1	79
SBA6700DZ-1/4	7314150241859	1	79
SBA6700DZ-11/32	7314150241866	1	79
SBA6700DZ-3/16	7314150241873	1	79
SBA6700DZ-3/8	7314150241880	1	79
SBA6700DZ-5/16	7314150241897	1	79
SBA6700DZ-7/16	7314150241903	1	79
SBA6700DZ-7/32	7314150241910	1	79
SBA6700DZ-9/16	7314150241927	1	79
SBA6700DZ-9/32	7314150241934	1	79
SBA6709M-2.5	7314150254835	1	83
SBA6709M-3	7314150254828	1	83
SBA6709M-4	7314150254811	1	83
SBA6709M-5	7314150254804	1	83
SBA6709M-6	7314150254798	1	83
SBA6709Z-1/8	7314150254781	1	83
SBA6709Z-3/16	7314150254774	1	83
SBA6709Z-5/32	7314150254767	1	83
SBA6709Z-9/64	7314150254750	1	83
SBA6800DM-10	7314150250172	1	79
SBA6800DM-11	7314150250189	1	79
SBA6800DM-12	7314150250196	1	79
SBA6800DM-13	7314150250202	1	79
SBA6800DM-14	7314150250219	1	79
SBA6800DM-4	7314150250226	1	79
SBA6800DM-5	7314150250233	1	79
SBA6800DM-5.5	7314150250240	1	79
SBA6800DM-6	7314150250257	1	79
SBA6800DM-7	7314150250264	1	79
SBA6800DM-8	7314150250271	1	79
SBA6800DM-9	7314150250288	1	79
SBA6800DZ-1/2	7314150250295	1	80
SBA6800DZ-1/4	7314150250301	1	80
SBA6800DZ-11/32	7314150250318	1	80
SBA6800DZ-3/16	7314150250325	1	80
SBA6800DZ-3/8	7314150250332	1	80
SBA6800DZ-5/16	7314150250349	1	80
SBA6800DZ-7/16	7314150250356	1	80
SBA6800DZ-7/32	7314150250363	1	80
SBA6800DZ-9/16	7314150250370	1	80
SBA6800DZ-9/32	7314150250387	1	80
SBA7400DM-10	7314150241941	1	85
SBA7400DM-11	7314150241958	1	85
SBA7400DM-12	7314150241965	1	85
SBA7400DM-13	7314150241972	1	85
SBA7400DM-14	7314150241989	1	85
SBA7400DM-15	7314150241996	1	85
SBA7400DM-16	7314150242009	1	85
SBA7400DM-17	7314150242016	1	85
SBA7400DM-18	7314150242023	1	85
SBA7400DM-19	7314150242030	1	85
SBA7400DM-20	7314150242047	1	85
SBA7400DM-21	7314150242054	1	85
SBA7400DM-22	7314150242061	1	85
SBA7400DM-6	7314150242078	1	85
SBA7400DM-7	7314150242085	1	85
SBA7400DM-8	7314150242092	1	85
SBA7400DM-9	7314150242108	1	85
SBA7400DZ-1/2	7314150254705	1	86
SBA7400DZ-1/4	7314150242115	1	86
SBA7400DZ-11/16	7314150242122	1	86
SBA7400DZ-13/16	7314150242139	1	86
SBA7400DZ-17/32	7314150242146	1	86
SBA7400DZ-19/32	7314150242153	1	86
SBA7400DZ-3/4	7314150242160	1	86
SBA7400DZ-3/8	7314150242177	1	86
SBA7400DZ-5/16	7314150242184	1	86
SBA7400DZ-5/8	7314150242191	1	86
SBA7400DZ-7/16	7314150242207	1	86
SBA7400DZ-7/8	7314150242214	1	86
SBA7400DZ-9/16	7314150242221	1	86
SBA7402DM-10	7314150250394	1	86
SBA7402DM-11	7314150250400	1	86
SBA7402DM-12	7314150250417	1	86
SBA7402DM-13	7314150250424	1	86
SBA7402DM-14	7314150250431	1	86
SBA7402DM-15	7314150250448	1	86
SBA7402DM-16	7314150250455	1	86
SBA7402DM-17	7314150250462	1	86
SBA7402DM-18	7314150250479	1	86
SBA7402DM-19	7314150250486	1	86
SBA7402DM-7	7314150250493	1	86



SBA7402DM-8	7314150250509	1	86
SBA7402DM-9	7314150250516	1	86
SBA7402DZ-1/2	7314150250523	1	86
SBA7402DZ-1/4	7314150250530	1	86
SBA7402DZ-11/16	7314150250547	1	86
SBA7402DZ-13/16	7314150250554	1	86
SBA7402DZ-19/32	7314150250561	1	86
SBA7402DZ-3/4	7314150250578	1	86
SBA7402DZ-3/8	7314150250585	1	86
SBA7402DZ-5/16	7314150250592	1	86
SBA7402DZ-5/8	7314150250608	1	86
SBA7402DZ-7/16	7314150250615	1	86
SBA7402DZ-7/8	7314150250622	1	86
SBA7402DZ-9/16	7314150250639	1	86
SBC110-65	7314150456246	1	573
SBE-8135TB	7314150320424	1	199
SBE-8145TB	7314150320431	1	199
SBE-8150TB	7314150320448	1	199
SBE-8155TB	7314150320455	1	199
SBE-8610TB	7314150320493	1	199
SBE-8620TB	7314150320509	1	199
SBE-8810TB	7314150320530	1	199
SBE-8820TB	7314150320547	1	199
SBE-8915TB	7314150320585	1	200
SBE-8920TB	7314150320592	1	200
SBE-8925TB	7314150320608	1	200
SBE-8930TB	7314150320622	1	200
SBE-8940TB	7314150320639	1	200
SBK6701M-10	7314150445233	1	172
SBK6701M-11	7314150445240	1	172
SBK6701M-12	7314150445264	1	172
SBK6701M-13	7314150445271	1	172
SBK6701M-14	7314150445288	1	172
SBK6701M-6	7314150445196	1	172
SBK6701M-7	7314150445202	1	172
SBK6701M-8	7314150445219	1	172
SBK6701M-9	7314150445226	1	172
SBK7401M-10	7314150445325	1	173
SBK7401M-11	7314150445332	1	173
SBK7401M-12	7314150445349	1	173
SBK7401M-13	7314150445356	1	173
SBK7401M-14	7314150445363	1	173
SBK7401M-15	7314150445370	1	173
SBK7401M-16	7314150445387	1	173
SBK7401M-17	7314150445394	1	173
SBK7401M-18	7314150445400	1	173
SBK7401M-19	7314150445417	1	173
SBK7401M-20	7314150445424	1	173
SBK7401M-21	7314150445431	1	173
SBK7401M-22	7314150445448	1	173
SBK7401M-24	7314150445455	1	173
SBK7401M-7	7314150445295	1	173
SBK7401M-8	7314150445301	1	173
SBK7401M-9	7314150445318	1	173
SBK7764D	7314150447800	1	177
SBK7801M-10	7314150445486	1	175
SBK7801M-11	7314150445493	1	175
SBK7801M-12	7314150445509	1	175
SBK7801M-13	7314150445516	1	175
SBK7801M-14	7314150445523	1	175
SBK7801M-15	7314150445530	1	175
SBK7801M-16	7314150445547	1	175
SBK7801M-17	7314150445554	1	175
SBK7801M-18	7314150445561	1	175
SBK7801M-19	7314150445578	1	175
SBK7801M-20	7314150445585	1	175
SBK7801M-21	7314150445592	1	175
SBK7801M-22	7314150445608	1	175
SBK7801M-23	7314150445615	1	175
SBK7801M-24	7314150445622	1	175
SBK7801M-25	7314150445639	1	175
SBK7801M-26	7314150445646	1	175
SBK7801M-27	7314150445653	1	175
SBK7801M-28	7314150450763	1	175
SBK7801M-29	7314150450770	1	175
SBK7801M-30	7314150445660	1	175
SBK7801M-32	7314150445677	1	175
SBK7801M-34	7314150445684	1	175
SBK7801M-36	7314150445691	1	175
SBK7801M-8	7314150445462	1	175
SBK7801M-9	7314150445479	1	175
SBK7801Z-1	7314150448036	1	176
SBK7801Z-1.1/16	7314150448142	1	176
SBK7801Z-1.1/2	7314150448203	1	176
SBK7801Z-1.1/4	7314150448166	1	176
SBK7801Z-1.1/8	7314150448159	1	176
SBK7801Z-1.3/8	7314150448180	1	176
SBK7801Z-1.5/16	7314150448173	1	176
SBK7801Z-1.7/16	7314150448197	1	176
SBK7801Z-1/2	7314150448067	1	176
SBK7801Z-11/16	7314150448098	1	176
SBK7801Z-13/16	7314150448111	1	176
SBK7801Z-15/16	7314150448135	1	176
SBK7801Z-3/4	7314150448104	1	176



SBK7801Z-3/8



SBK7801Z-3/8	7314150448043	1	176
SBK7801Z-5/8	7314150448081	1	176
SBK7801Z-7/16	7314150448050	1	176
SBK7801Z-7/8	7314150448128	1	176
SBK7801Z-9/16	7314150448074	1	176
SBK7806M-10	7314150447831	1	176
SBK7806M-11	7314150447862	1	176
SBK7806M-12	7314150447879	1	176
SBK7806M-13	7314150447886	1	176
SBK7806M-14	7314150447893	1	176
SBK7806M-15	7314150447909	1	176
SBK7806M-16	7314150447916	1	176
SBK7806M-17	7314150447923	1	176
SBK7806M-18	7314150447930	1	176
SBK7806M-19	7314150447947	1	176
SBK7806M-21	7314150447954	1	176
SBK7806M-22	7314150447961	1	176
SBK7806M-23	7314150447978	1	176
SBK7806M-24	7314150447985	1	176
SBK7806M-27	7314150447992	1	176
SBK7806M-30	7314150448005	1	176
SBK7806M-32	7314150448012	1	176
SBK7806M-36	7314150448029	1	176
SBK7806Z-1	7314150448401	1	177
SBK7806Z-1.1/16	7314150448418	1	177
SBK7806Z-1.1/2	7314150448470	1	177
SBK7806Z-1.1/4	7314150448432	1	177
SBK7806Z-1.1/8	7314150448425	5	177
SBK7806Z-1.3/8	7314150448456	5	177
SBK7806Z-1.5/16	7314150448449	1	177
SBK7806Z-1.7/16	7314150448463	5	177
SBK7806Z-1/2	7314150448326	10	176
SBK7806Z-11/16	7314150448357	1	176
SBK7806Z-13/16	7314150448371	1	176
SBK7806Z-15/16	7314150448395	1	176
SBK7806Z-3/4	7314150448364	1	176
SBK7806Z-3/8	7314150448302	10	176
SBK7806Z-5/8	7314150448340	5	176
SBK7806Z-7/16	7314150448319	10	176
SBK7806Z-7/8	7314150448388	1	176
SBK7806Z-9/16	7314150448333	10	176
SBK8160D-1	7314150447770	1	177
SBK8160D-2	7314150447787	1	177
SBK8160D-3	7314150447794	1	177
SBK8901M-17	7314150448487	1	179
SBK8901M-18	7314150448494	1	179
SBK8901M-19	7314150448500	1	179
SBK8901M-21	7314150448517	1	179
SBK8901M-22	7314150448524	1	179
SBK8901M-23	7314150448531	1	179
SBK8901M-24	7314150448548	1	179
SBK8901M-27	7314150448555	1	179
SBK8901M-28	7314150448562	1	179
SBK8901M-29	7314150448579	1	179
SBK8901M-30	7314150448586	1	179
SBK8901M-32	7314150448593	1	179
SBK8901M-33	7314150448609	1	179
SBK8901M-34	7314150448616	1	179
SBK8901M-36	7314150448623	1	179
SBK8901M-38	7314150448630	1	179
SBK8901M-41	7314150448647	1	179
SBK8901M-46	7314150448654	1	179
SBK8901M-50	7314150448661	1	179
SBK8901M-55	7314150448678	1	179
SBK8901M-60	7314150448685	1	179
SBK8964D	7314150447817	1	177
SBS19-TH10	7314150190072	1	90
SBS19-TH11	7314150190089	1	90
SBS19-TH12	7314150190096	1	90
SBS19-TH13	7314150190102	1	90
SBS19-TH14	7314150190119	1	90
SBS19-TH15	7314150190126	1	90
SBS19-TH16	7314150190133	1	90
SBS19-TH17	7314150190140	1	90
SBS19-TH18	7314150190157	1	90
SBS19-TH19	7314150190164	1	90
SBS19-TH21	7314150190256	1	90
SBS19-TH22	7314150190188	1	90
SBS19-TH24	7314150190195	1	90
SBS19-TH75	7314150190201	1	90
SBS20-12	7314153009166	1	41
SBS20-15	7314153009197	1	41
SBS20-16	7314153009203	1	41
SBS20-20	7314153009241	1	41
SBS20-9	7314153009135	1	41
SBS61	7314153009661	1	84
SBS61S	7314150179886	1	84
SBS750	7314153012883	10	89
SBS81	7314153009937	5	97



SBSL25	7314153015853	5	63
SC127	7314150121984	10	579
SC127S	7314150121991	10	579
SC127V	7314150121847	5	502
SC140	7314150122004	10	579
SC140C	7314150122011	10	579
SC150NG	7314150122028	10	579
SC150NGV	7314150121854	5	502
SC2RM-13-17	7314150265350	10	102
SC2RM-15-17	7314150265367	10	102
SC2RM-19-22	7314150181384	10	102
SC2RM-27-30	7314150265343	1	102
SC335M-17	7314150344314	1	52
SC335M-19	7314150344321	1	52
SC335M-22	7314150344338	1	52
SC335M-24	7314150344345	1	52
SC335M-27	7314150344352	1	52
SC335M-30	7314150344369	1	52
SC335M-32	7314150344376	1	52
SC335M-36	7314150344383	1	52
SC335M-41	7314150344390	1	52
SC335M-46	7314150344406	1	52
SCB140	7314150297351	10	579
SCB140G	7314150297368	10	579
SCRAPER-SET2	7311518228613	1	548
SE-15-24	7311518029838	5	633
SE-15-30	7311518029821	5	633
SE-15-30-23	7311518029845	5	633
SE-15-32	7311518249168	5	633
SE-15-36	7311518141202	5	633
SE-15-36-23	7311518258276	5	633
SE-16-21	7311518029807	5	633
SE-16-21-23	7311518273934	5	633
SH-407	7314150389827	1	596
SH-427-700	7314150349074	10	596
SH-428-700	7314150349081	10	596
SH-485W	7314150358021	1	594
SH-485W-PLATES	7314150358038	1	594
SH-486-493-495	7314150349098	10	596
SH-486F493F495F	7314150349104	10	596
SH-486W	7314150358014	1	596
SH-488-2000	7314150346912	10	596
SH-488-34	7314150349036	10	596
SH-488-56	7314150349043	10	596
SH-488F-2000	7314150346950	10	596
SH-488F-34	7314150349050	1	596
SH-488F-56	7314150349067	1	596
SH-491-34	7314150374298	12	596
SH-491-56	7314150374304	12	596
SH-FCP-860	7311518324421	1	601
SH-FCS-810	7311518140540	1	601
SH-FCS-860	7311518140557	1	601
SH-FGS-1.8-810	7311518327828	1	601
SH-FGS-600	7311518140649	1	601
SH-FGS-700	7311518140656	12	601
SH-FGS-800	7311518140663	1	601
SH-HFGPS-400FG	7311518282301	1	601
SH-HGPS-360	7311518140618	12	601
SH-HGPS-380	7311518140625	1	601
SH-HGPS-400	7311518207618	1	601
SH-HUS-380	7311518140502	1	601
SH-HUS-500	7311518140519	1	601
SH-HUS-650	7311518140526	1	601
SH-MCS-800	7311518140595	1	601
SH-MES-900	7311518140601	12	601
SH-MES-900FG	7311518282318	12	601
SH-MES-F-900	7311518141554	12	601
SH-PAGS-900	7311518327866	1	601
SH-PAGS-900FG	7311518326944	1	601
SH-SUS-800	7311518140809	12	601
SHARP-INS	7314150197897	100	566
SHARP-X	7311518264895	10	636
SHARP-X-DISP	7311518264901	1	636
SL24	7314150128389	1	64
SL25	7314153013422	20	63
SL25AF	7314150180141	20	64
SL25L	7314150256570	10	64
SL34	7314150409181	6	70
SL65	7314150444137	6	64
SLX 17	7314153015785	1	76
SLX 17AF	7314150137558	1	76
SLX17-CASE	7314150321254	1	102
SP120	7314150312474	1	95
SP120XL	7314150313594	1	95
SPAR-CASE-A4	7314150263523	1	102
SPAR-CASE-A6	7314150263547	1	102
SPAR-CASE-A7	7314150263554	1	102
SQZ-MINI	7314150186280	24	582
SQZ-MINI-BLADE	7314150190348	1	582



SQZ150003	7314153013477	6	580
SQZ150003-HSBL	7314153015389	6	581
SR1000-E	7314150302918	20	544
SR1000-MM	7314150302857	20	543
SR150-E	7314150302864	12	544
SR150-MM	7314150302819	12	543
SR200-E	7314150302871	12	544
SR200-MM	7314150302826	12	543
SR300-E	7314150302888	12	544
SR300-MM	7314150302833	12	543
SR600-E	7314150302901	20	544
SR600-MM	7314150302840	20	543
SS001-100	7314150404384	1	526
SS001-150	7314150404377	1	526
SS001-200	7314150404391	1	526
SS001-250	7314150404407	1	526
SS001-300	7314150404414	1	526
SS001-375	7314150404421	1	526
SS001-450	7314150404438	1	526
SS001-600	7314150404445	1	526
SS002-10	7314150404483	1	526
SS002-11	7314150404490	1	526
SS002-12	7314150404506	1	526
SS002-13	7314150404513	1	526
SS002-14	7314150404520	1	526
SS002-15	7314150404537	1	526
SS002-16	7314150404551	1	526
SS002-17	7314150404568	1	526
SS002-19	7314150404575	1	526
SS002-21	7314150404582	1	526
SS002-22	7314150404599	1	526
SS002-24	7314150404605	1	526
SS002-27	7314150404612	1	526
SS002-32	7314150404629	1	526
SS002-6	7314150404469	1	526
SS002-6-2	7314150407903	1	526
SS002-7	7314150445790	1	526
SS002-8	7314150404476	1	526
SS002-9-2	7314150407910	1	526
SS003-10	7314150404643	1	526
SS003-11	7314150404650	1	526
SS003-12	7314150404667	1	526
SS003-14	7314150404681	1	526
SS003-16	7314150404704	1	526
SS003-18	7314150404711	1	526
SS003-20	7314150404728	1	526
SS003-22	7314150404735	1	526
SS003-24	7314150404742	1	526
SS003-25	7314150404759	1	526
SS003-26	7314150404766	1	526
SS003-28	7314150404773	1	526
SS003-30	7314150404780	1	526
SS003-8	7314150404636	1	526
SS011-0507	7314150404797	1	526
SS011-0607	7314150404803	1	526
SS011-0809	7314150404810	1	526
SS011-0810	7314150404827	1	526
SS011-0911	7314150404834	1	526
SS011-1012	7314150404858	1	526
SS011-11-3	7314150419142	1	527
SS011-1214	7314150404865	1	526
SS011-1417	7314150404872	1	526
SS011-1618	7314150404889	1	526
SS011-1719	7314150404896	1	526
SS011-1722	7314150404902	1	526
SS011-2224	7314150404919	1	526
SS011-2427	7314150404926	1	526
SS011-2430	7314150404940	1	526
SS011-3032	7314150404957	1	526
SS011-9-3	7314150419135	1	526
SS210-10	7314150405343	1	527
SS210-11	7314150405350	1	527
SS210-12	7314150405367	1	527
SS210-13	7314150405374	1	527
SS210-14	7314150405381	1	527
SS210-4	7314150405268	1	527
SS210-4.5	7314150405275	1	527
SS210-5	7314150405282	1	527
SS210-5.5	7314150405299	1	527
SS210-6	7314150405305	1	527
SS210-7	7314150405312	1	527
SS210-8	7314150405329	1	527
SS210-9	7314150405336	1	527
SS220-10	7314150404995	1	527
SS220-11	7314150405008	1	527
SS220-12	7314150405022	1	527
SS220-13	7314150405039	1	527
SS220-14	7314150405053	1	527
SS220-15	7314150405060	1	527



SS220-16	7314150405077	1	527
SS220-17	7314150405084	1	527
SS220-18	7314150405091	1	527
SS220-19	7314150405114	1	527
SS220-20	7314150405121	1	527
SS220-21	7314150405138	1	527
SS220-22	7314150405145	1	527
SS220-23	7314150405152	1	527
SS220-24	7314150405176	1	527
SS220-25	7314150405183	1	527
SS220-26	7314150405190	1	527
SS220-27	7314150405206	1	527
SS220-28	7314150405213	1	527
SS220-29	7314150405220	1	527
SS220-30	7314150405237	1	527
SS220-31	7314150405244	1	527
SS220-32	7314150405251	1	527
SS220-8	7314150404964	1	527
SS220-9	7314150404988	1	527
SS224-17	7314150405398	1	527
SS224-19	7314150405404	1	527
SS224-22	7314150405411	1	527
SS224-24	7314150405428	1	527
SS224-27	7314150405435	1	527
SS224-30	7314150405442	1	527
SS224-32	7314150405459	1	527
SS224-34	7314150405466	1	527
SS224-36	7314150405473	1	527
SS224-41	7314150405480	1	527
SS224-46	7314150405497	1	527
SS224-50	7314150405503	1	527
SS224-55	7314150405510	1	527
SS224-60	7314150405527	1	527
SS224-65	7314150405534	1	527
SS234-16-100	7314150405572	1	527
SS234-16-200	7314150405589	1	527
SS234-16-250	7314150405602	1	527
SS234-24-100	7314150405619	1	527
SS234-24-200	7314150405626	1	527
SS234-24-250	7314150405633	1	527
SS236-08-80	7314150405718	1	527
SS236-16-80	7314150405701	1	527
SS236-24-110	7314150405725	1	527
SS238-08-250	7314150405657	1	527
SS238-16-250	7314150405640	1	527
SS238-24-350	7314150405664	1	527
SS242-08-200	7314150405558	1	528
SS242-16-245	7314150405541	1	528
SS242-24-320	7314150405565	1	528
SS243-08	7314150405688	1	527
SS243-16	7314150405671	1	527
SS243-24	7314150405695	1	527
SS324-1.5	7314150405732	2	528
SS324-10	7314150405824	1	528
SS324-2	7314150405749	2	528
SS324-2.5	7314150405756	2	528
SS324-3	7314150405763	1	528
SS324-4	7314150405770	1	528
SS324-5	7314150405787	1	528
SS324-6	7314150405794	1	528
SS324-8	7314150405817	1	528
SS325-10	7314150405886	1	529
SS325-12	7314150405879	1	529
SS325-2.5	7314150405909	2	529
SS325-3	7314150405862	2	529
SS325-3.5	7314150405923	2	529
SS325-4	7314150405848	1	529
SS325-4.5	7314150405930	1	529
SS325-5	7314150405893	1	529
SS325-6	7314150405855	1	529
SS325-7	7314150405916	1	529
SS325-8	7314150405831	1	529
SS400-160	7314150405978	1	529
SS400-180	7314150405985	1	529
SS400-200	7314150405992	1	529
SS402-160	7314150406005	1	530
SS402-200	7314150406012	1	530
SS406-160	7314150406029	1	530
SS406-200	7314150406036	1	530
SS410-250	7314150406043	1	530
SS410-300	7314150406050	1	530
SS412-200	7314150406067	1	530
SS415-225	7314150406074	1	530
SS502-1000-FB	7314150406081	1	530
SS502-1500-FB	7314150406098	1	530
SS502-2000-FB	7314150406104	1	530
SS502-2500-FB	7314150406111	1	530
SS502-3000-FB	7314150406128	1	530
SS502-3600-FB	7314150406135	1	530



SS506-1100-FB



SS506-1100-FB	7314150406197	1	530
SS506-200-FB	7314150406142	1	530
SS506-300-FB	7314150406159	1	530
SS506-500-FB	7314150406166	1	530
SS506-700-FB	7314150406173	1	530
SS506-900-FB	7314150406180	1	530
SS603-15-500	7314150406203	1	530
SS603-19-500	7314150406210	1	530
SS603-20-500	7314150406227	1	530
SS603-23-500	7314150406234	1	530
SS603-23-800	7314150406258	1	530
SS603-25-600	7314150406241	1	530
SS603-30-1000	7314150406265	1	530
SS610-16-160	7314150406272	1	530
SS610-18-200	7314150406289	1	530
SS610-24-300	7314150406296	1	530
SS610-25-400	7314150406302	1	530
SS610-30-500	7314150406319	1	530
SUP-20-LAM	7311518258351	4	563
SUS-2.0-800	7311518123451	4	600
SW65	7314150442898	6	64
SW79	7314150442904	4	63
SW91	7314150442942	4	63
TAH08-10	7314150305087	1	477
TAH08-11	7314150305094	1	477
TAH08-12	7314150305100	1	477
TAH08-13	7314150305117	1	477
TAH08-5.5	7314150305032	1	477
TAH08-6	7314150305049	1	477
TAH08-7	7314150305056	1	477
TAH08-8	7314150305063	1	477
TAH08-9	7314150305070	1	477
TAH08-H3	7314150305124	1	477
TAH08-H4	7314150305131	1	477
TAH08-H5	7314150305148	1	477
TAH08-H6	7314150305155	1	477
TAH08-H8	7314150305162	1	477
TAH08-PH1	7314150305179	1	477
TAH08-PH2	7314150305186	1	477
TAH08-PH3	7314150305193	1	477
TAH08-T10	7314150305223	1	478
TAH08-T15	7314150305230	1	478
TAH08-T20	7314150305247	1	478
TAH08-T25	7314150305254	1	478
TAH08-T27	7314150305261	1	478
TAH08-T30	7314150305278	1	478
TAH08-T40	7314150305285	1	478
TAH08-T8	7314150305209	1	478
TAH08-T9	7314150305216	1	478
TAH1-100-06-2-4	7314150307531	1	485
TAH1-110-08-1-2	7314150437825	1	485
TAH1-143-12-1-2	7314150307548	1	485
TAH1-160-08-1-2	7314150437818	1	485
TAH1-170-08-1-2	7314150437801	1	485
TAH1-210-06-2-2	7314150307555	1	485
TAH1-210-08-1-2	7314150437795	1	485
TAH1-230-06-2-2	7314150307562	1	485
TAH1-230-08-1-2	7314150437788	1	485
TAH111M-10	7314150308538	1	475
TAH111M-11	7314150308545	1	475
TAH111M-12	7314150308552	1	475
TAH111M-13	7314150308569	1	475
TAH111M-14	7314150308576	1	475
TAH111M-15	7314150308583	1	475
TAH111M-16	7314150308590	1	475
TAH111M-17	7314150308606	1	475
TAH111M-18	7314150308613	1	475
TAH111M-19	7314150308620	1	475
TAH111M-20	7314150308637	1	475
TAH111M-21	7314150308644	1	475
TAH111M-22	7314150308651	1	475
TAH111M-23	7314150308668	1	475
TAH111M-24	7314150308675	1	475
TAH111M-25	7314150308682	1	475
TAH111M-27	7314150308689	1	475
TAH111M-30	7314150308699	1	475
TAH111M-32	7314150308705	1	475
TAH111M-34	7314150308712	1	475
TAH111M-36	7314150308729	1	475
TAH111M-41	7314150308736	1	475
TAH111M-46	7314150308743	1	475
TAH111M-50	7314150308750	1	475
TAH111M-55	7314150411573	1	475
TAH111M-6	7314150308491	1	475
TAH111M-7	7314150308507	1	475
TAH111M-8	7314150308514	1	475
TAH111M-9	7314150308521	1	475
TAH111Z-1	7314150343362	1	475
TAH111Z-1.1/16	7314150343379	1	475



TAH111Z-1.1/2	7314150431830	1	475
TAH111Z-1.1/4	7314150343386	1	475
TAH111Z-1.1/8	7314150343393	1	475
TAH111Z-1.11/16	7314150431854	1	475
TAH111Z-1.13/16	7314150431878	1	475
TAH111Z-1.3/4	7314150431861	1	475
TAH111Z-1.3/8	7314150431816	1	475
TAH111Z-1.5/16	7314150343409	1	475
TAH111Z-1.5/8	7314150431847	1	475
TAH111Z-1.7/16	7314150431823	1	475
TAH111Z-1.7/8	7314150431885	1	475
TAH111Z-1/2	7314150343461	1	475
TAH111Z-1/4	7314150343508	1	475
TAH111Z-11/16	7314150343522	1	475
TAH111Z-13/16	7314150343539	1	475
TAH111Z-15/16	7314150343546	1	475
TAH111Z-2	7314150431892	1	475
TAH111Z-2.1/4	7314150431915	1	475
TAH111Z-2.3/4	7314150431946	1	475
TAH111Z-2.3/8	7314150413959	1	475
TAH111Z-2.5/8	7314150431939	1	475
TAH111Z-2.7/8	7314150431953	1	475
TAH111Z-3	7314150431960	1	475
TAH111Z-3/4	7314150343553	1	475
TAH111Z-3/8	7314150343560	1	475
TAH111Z-5/16	7314150343591	1	475
TAH111Z-5/8	7314150343607	1	475
TAH111Z-7/16	7314150343614	1	475
TAH111Z-7/8	7314150343621	1	475
TAH111Z-9/16	7314150343638	1	475
TAH1150-1/2H/P	7314150307760	1	488
TAH1177-SCRIBE	7314150307777	1	488
TAH140	7314150344475	1	477
TAH141	7314150339433	1	477
TAH1410	7314150344543	1	477
TAH142	7314150339440	1	477
TAH1420	7314150344550	1	477
TAH143	7314150344482	1	477
TAH1544	7314150307746	1	489
TAH16-H10	7314150306176	1	479
TAH16-H12	7314150306183	1	479
TAH16-H14	7314150306190	1	479
TAH16-H17	7314150306206	1	479
TAH16-H19	7314150306213	1	479
TAH16-H4	7314150306121	1	479
TAH16-H5	7314150306138	1	479
TAH16-H6	7314150306145	1	479
TAH16-H7	7314150306152	1	479
TAH16-H8	7314150306169	1	479
TAH16-T30	7314150306220	1	479
TAH16-T40	7314150306237	1	479
TAH16-T45	7314150306244	1	479
TAH16-T50	7314150306251	1	479
TAH16-T55	7314150306268	1	479
TAH16-T60	7314150306275	1	479
TAH16B-1	7314150306077	1	478
TAH16B-1.1/16	7314150306084	1	478
TAH16B-1.1/4	7314150306107	1	478
TAH16B-1.1/8	7314150306114	1	478
TAH16B-1/2	7314150305995	1	478
TAH16B-10	7314150305629	1	478
TAH16B-11	7314150305636	1	478
TAH16B-11/16	7314150306022	1	478
TAH16B-12	7314150305643	1	478
TAH16B-13	7314150305650	1	478
TAH16B-13/16	7314150306046	1	478
TAH16B-14	7314150305667	1	478
TAH16B-15	7314150305674	1	478
TAH16B-15/16	7314150306060	1	478
TAH16B-16	7314150305698	1	478
TAH16B-17	7314150305704	1	478
TAH16B-18	7314150305711	1	478
TAH16B-19	7314150305728	1	478
TAH16B-21	7314150305735	1	478
TAH16B-22	7314150305742	1	478
TAH16B-24	7314150305759	1	478
TAH16B-25	7314150305766	1	478
TAH16B-27	7314150305773	1	478
TAH16B-3/4	7314150306039	1	478
TAH16B-30	7314150305780	1	478
TAH16B-32	7314150305797	1	478
TAH16B-5/8	7314150306015	1	478
TAH16B-7/8	7314150306053	1	478
TAH16B-8	7314150305612	1	478
TAH16B-9/16	7314150306008	1	478
TAH16BM/22	7314150422357	1	479
TAH16BZ/17	7314150422340	1	479
TAH16H-1/2	7314150306329	1	479
TAH16H-1/4	7314150306282	1	479

TAH16H-3/8	7314150306305	1	479
TAH16H-5/16	7314150306299	1	479
TAH16H-5/8	7314150306343	1	479
TAH16H-7/16	7314150306312	1	479
TAH16H-9/16	7314150306336	1	479
TAH1949M-10-11	7314150308866	1	476
TAH1949M-12-14	7314150308873	1	476
TAH1949M-14-17	7314150308880	1	476
TAH1949M-19-22	7314150308897	1	476
TAH1949M-24-27	7314150308903	1	476
TAH1949M-8-9	7314150308859	1	476
TAH1995M-10	7314150432219	1	482
TAH1995M-12	7314150432226	1	482
TAH1995M-8	7314150432202	1	482
TAH1995Z-1/2	7314150415007	1	482
TAH1RM-10	7314150414338	1	475
TAH1RM-11	7314150424306	1	475
TAH1RM-12	7314150424313	1	475
TAH1RM-13	7314150414345	1	475
TAH1RM-14	7314150424320	1	475
TAH1RM-15	7314150424337	1	475
TAH1RM-16	7314150414352	1	475
TAH1RM-17	7314150352210	1	475
TAH1RM-18	7314150414369	1	475
TAH1RM-19	7314150352227	1	475
TAH1RM-21	7314150424344	1	475
TAH1RM-22	7314150424351	1	475
TAH1RM-24	7314150352234	1	475
TAH1RM-27	7314150424368	1	475
TAH1RM-30	7314150352241	1	475
TAH1RM-32	7314150424375	1	475
TAH1RM-6	7314150424269	1	475
TAH1RM-7	7314150424276	1	475
TAH1RM-8	7314150424283	1	475
TAH1RM-9	7314150424290	1	475
TAH2047-0.8-4	7314150308088	1	482
TAH2047PR-1-2	7314150308095	1	482
TAH2101G-125	7314150344581	1	482
TAH2101G-125C	7314150344598	1	482
TAH2101G-140	7314150307869	1	482
TAH2101G-140C	7314150344611	1	482
TAH2101G-160	7314150307876	1	482
TAH2101G-160C	7314150344635	1	482
TAH2101G-180	7314150345106	1	482
TAH2101G-180C	7314150344666	1	482
TAH21HDG-200	7314150345649	1	483
TAH21HDG-200C	7314150345656	1	483
TAH2223G-150	7314150411597	1	483
TAH225-PLUS	7314150319978	1	485
TAH2339-250	7314150536320	1	484
TAH2427G-200	7314150307883	1	483
TAH2430G-160	7314150413942	1	483
TAH2430G-200	7314150307906	1	483
TAH2484-30	7314150307968	1	487
TAH2487	7314150320028	1	489
TAH24B-27	7314150309306	1	479
TAH24B-30	7314150309313	1	479
TAH24B-32	7314150309320	1	479
TAH24B-36	7314150309337	1	479
TAH24B-38	7314150309344	1	479
TAH24B-41	7314150309351	1	479
TAH24B-46	7314150309368	1	479
TAH24B-50	7314150309375	1	479
TAH2509	7314150307753	1	490
TAH2535F2	7314150307784	1	490
TAH2628G-160	7314150307913	1	483
TAH2628G-180	7314150307920	1	483
TAH2628G-200	7314150432363	1	483
TAH2633/S4	7314150415014	1	490
TAH2800-150	7314150519330	1	483
TAH2800-180	7314150424559	1	483
TAH2820EF2	7314150307708	1	485
TAH2855	7314150307937	1	484
TAH2900-180	7314150424566	1	483
TAH2951-250	7314150432400	1	484
TAH2953-140	7314150415731	1	484
TAH2953-300	7314150415748	1	484
TAH2958-200	7314150320219	1	484
TAH2958-250	7314150307944	1	484
TAH2970G-200	7314150343331	1	483
TAH29M-10	7314150414413	1	476
TAH29M-11	7314150414420	1	476
TAH29M-12	7314150424382	1	476
TAH29M-13	7314150414437	1	476
TAH29M-14	7314150424399	1	476
TAH29M-15	7314150424405	1	476
TAH29M-16	7314150424412	1	476
TAH29M-17	7314150414444	1	476
TAH29M-18	7314150424429	1	476

TAH29M-19	7314150424436	1	476
TAH29M-20	7314150424443	1	476
TAH29M-21	7314150414451	1	476
TAH29M-22	7314150424450	1	476
TAH29M-23	7314150424467	1	476
TAH29M-24	7314150424474	1	476
TAH29M-25	7314150424481	1	476
TAH29M-26	7314150424498	1	476
TAH29M-27	7314150424504	1	476
TAH29M-28	7314150424511	1	476
TAH29M-29	7314150424528	1	476
TAH29M-30	7314150424535	1	476
TAH29M-32	7314150424542	1	476
TAH29M-6	7314150414376	1	476
TAH29M-7	7314150414383	1	476
TAH29M-8	7314150414390	1	476
TAH29M-9	7314150414406	1	476
TAH2M-10-11	7314150427772	1	476
TAH2M-12-13	7314150427789	1	476
TAH2M-14-15	7314150427796	1	476
TAH2M-16-17	7314150427802	1	476
TAH2M-18-19	7314150427819	1	476
TAH2M-6-7	7314150427758	1	476
TAH2M-8-9	7314150427765	1	476
TAH317	7314150319985	1	485
TAH320	7314150319992	1	484
TAH325	7314150320004	1	484
TAH3625PU-50	7314150307579	1	486
TAH3625W-35	7314150307609	1	486
TAH3640-250-C	7314150307975	1	487
TAH3681-11	7314150415038	1	488
TAH3681-16	7314150415045	1	488
TAH3681-20	7314150415052	1	488
TAH3683	7314150352258	1	487
TAH3734BM-10	7314150308057	1	487
TAH3734BM-2	7314150343348	1	487
TAH3734BM-3	7314150307982	1	487
TAH3734BM-4	7314150308019	1	487
TAH3734BM-5	7314150308026	1	487
TAH3734BM-6	7314150308033	1	487
TAH3734BM-8	7314150308040	1	487
TAH3739-300	7314150373925	1	487
TAH3755BM-4	7314150308064	1	487
TAH380-10	7314150307845	1	487
TAH380-14	7314150320172	1	477
TAH380-18	7314150307852	1	477
TAH380-24	7314150343317	1	477
TAH396-JT	7314150373932	1	484
TAH4205H-80-160	7314150411610	1	489
TAH466-250	7314150307791	1	488
TAH479-16	7314150307586	1	486
TAH479-32	7314150307593	1	486
TAH481-300	7314150307616	1	486
TAH484-1000	7314150373918	1	486
TAH484-1500	7314150307623	1	486
TAH484-2000	7314150319916	1	486
TAH485	7314150459902	1	487
TAH486F-700	7314150370658	1	486
TAH487-5200	7314150307630	1	487
TAH489-1100	7314150307647	1	486
TAH489-1800	7314150343294	1	486
TAH489-2700	7314150319923	1	486
TAH489-3600	7314150307654	1	486
TAH489-4500	7314150427567	1	486
TAH489-5400	7314150319930	1	486
TAH490-1100	7314150427475	1	486
TAH490-700	7314150427529	1	486
TAH490-900	7314150427536	1	486
TAH52	7314150339730	1	486
TAH6950	7314150309054	1	478
TAH6956-1	7314150309061	1	478
TAH6958B-1	7314150309078	1	477
TAH6960	7314150305315	1	477
TAH6961	7314150305322	1	477
TAH6962	7314150305339	1	477
TAH6962L	7314150305346	1	477
TAH6966	7314150305353	1	477
TAH6M-10-11	7314150370665	1	476
TAH6M-12-13	7314150370672	1	476
TAH6M-14-15	7314150400393	1	476
TAH6M-16-17	7314150400409	1	476
TAH6M-17-19	7314150370689	1	476
TAH6M-18-19	7314150400416	1	476
TAH6M-20-22	7314150400423	1	476
TAH6M-24-27	7314150400430	1	476
TAH6M-30-32	7314150400447	1	476
TAH6M-6-7	7314150427741	1	476
TAH6M-8-9	7314150400386	1	476
TAH700-1.5-50	7314150432301	1	481



TAH700-1.8-50



TAH700-1.8-50	7314150432318	1	481
TAH700-2.5-50	7314150432325	1	481
TAH700-3-100	7314150432332	1	481
TAH701-0-50	7314150432349	1	481
TAH701-00-50	7314150432356	1	481
TAH703-10-50	7314150432288	1	482
TAH703-15-75	7314150432295	1	482
TAH703-6-50	7314150432240	1	482
TAH703-7-50	7314150432257	1	482
TAH703-8-50	7314150432264	1	482
TAH703-9-50	7314150432271	1	482
TAH73R-100	7314150503810	1	489
TAH73R-200	7314150503834	1	489
TAH73R-300	7314150503858	1	489
TAH7444SG-M-36	7314150308934	1	476
TAH7444SG-M-41	7314150308941	1	476
TAH7444SG-M-46	7314150308958	1	476
TAH7444SG-M-50	7314150308965	1	476
TAH7444SG-M-55	7314150308972	1	476
TAH7445-100A-1	7314150327546	1	489
TAH7452-2	7314150302543	1	489
TAH7455-300-1	7314150309412	1	489
TAH74W9-100	7314150519354	1	489
TAH782-U	7314150339747	1	486
TAH7852-1	7314150302550	1	489
TAH8069	7314150383603	1	475
TAH8069C	7314150383610	1	475
TAH8070	7314150347025	1	475
TAH8070C	7314150383627	1	475
TAH8071	7314150347032	1	475
TAH8071C	7314150383634	1	475
TAH8072	7314150307487	1	475
TAH8072C	7314150383641	1	475
TAH8073	7314150319831	1	475
TAH8073C	7314150383658	1	475
TAH8074	7314150319848	1	475
TAH8074C	7314150383665	1	475
TAH8075	7314150307500	1	475
TAH8075C	7314150383672	1	475
TAH8150-1/2	7314150309283	1	479
TAH8158B-1	7314150309290	1	478
TAH8160	7314150306367	1	478
TAH8162	7314150306374	1	478
TAH8166	7314150306381	1	478
TAH8224	7314150307951	1	484
TAH84-PODGER	7314150312221	1	475
TAH8950N/A	7314150309382	1	480
TAH8953	7314150309399	1	479
TAH8961	7314150309405	1	479
TAH9045-B-250	7314150411634	1	488
TAH9048-250	7314150411627	1	488
TAH9070	7314150307517	1	475
TAH9072	7314150307524	1	475
TAHBE-8020L	7314150308101	1	480
TAHBE-8030	7314150308118	1	480
TAHBE-8040	7314150308125	1	480
TAHBE-8040S	7314150308132	1	481
TAHBE-8050S	7314150308149	1	481
TAHBE-8155	7314150308156	1	480
TAHBE-8220S	7314150308163	1	481
TAHBE-8241	7314150308217	1	480
TAHBE-8252	7314150308224	1	480
TAHBE-8255S	7314150320226	1	481
TAHBE-8257	7314150308231	1	480
TAHBE-8258	7314150308248	1	480
TAHBE-8260	7314150308255	1	480
TAHBE-8350	7314150308262	1	480
TAHBE-8602	7314150308279	1	480
TAHBE-8610	7314150308286	1	480
TAHBE-8610S	7314150308293	1	481
TAHBE-8611	7314150308309	1	480
TAHBE-8620	7314150308316	1	480
TAHBE-8620L	7314150308323	1	480
TAHBE-8620S	7314150308330	1	481
TAHBE-8623	7314150308347	1	480
TAHBE-8624	7314150308354	1	480
TAHBE-8630	7314150308361	1	480
TAHBE-8630S	7314150320233	1	481
TAHBE-8640S	7314150320240	1	481
TAHBE-8810	7314150308378	1	481
TAHBE-8820	7314150308385	1	481
TAHBE-8820SL	7314150347827	1	481
TAHBE-8830	7314150308392	1	481
TAHBE-8880	7314150432196	1	480
TAHBE-8910	7314150343713	1	481
TAHBE-8910S	7314150343799	1	481
TAHBE-8915	7314150343744	1	481
TAHBE-8915S	7314150343805	1	481
TAHBE-8920	7314150343751	1	481



TAHBE-8920S	7314150343812	1	481
TAHBE-8925	7314150343768	1	481
TAHBE-8925S	7314150343829	1	481
TAHBE-8930	7314150343775	1	481
TAHBE-8930S	7314150343836	1	481
TAHBE-9776	7314150432233	1	482
TAHBE-9777B	7314150307685	1	482
TAHBE-9787	7314150307692	1	482
TAHBE64520	7314150307821	1	490
TAHBFRL11	7314150307739	1	490
TAHBOD5400	7314150339457	1	490
TAHBOD5450	7314150339464	1	490
TAHCRW01	7314150432370	1	483
TAHCS300	7314150411603	1	488
TAHLTS-30	7314150432387	1	488
TAHMK5	7314150411580	1	476
TAHPINRELEASER	7314150307638	1	480
TAHSC2RM-13-17	7314150339792	1	476
TAHSC2RM-15-17	7314150339785	1	476
TAHSC2RM-19-22	7314150339761	1	476
TAHSC2RM-27-30	7314150339778	1	476
TAHSCB140G	7314150308071	1	485
TAHSR300-MM	7314150415021	1	488
TAHWBB600	7314150440429	1	487
TAHWBB700	7314150440436	1	487
TAM12135	7314150215331	1	115
TAM12200	7314150215348	1	115
TAM12340	7314150215355	1	115
TAM1430	7314150215317	1	115
TAM38135	7314150215324	1	115
TAS14H007	7314150423187	1	111
TAS14H09	7314150423200	1	111
TAS14S007	7314150423194	1	111
TAS14S09	7314150423217	1	111
TASM14H007	7314150539444	1	111
TASM14H09	7314150539437	1	111
TASMB14H007	7314150489664	1	111
TASMB14H09	7314150489671	1	111
TAW12340	7314150274963	1	105
TAW1412M	7314150423156	1	105
TAW1430M	7314150422289	1	105
TAW14340	7314150340842	1	105
TAW24800	7314150368297	1	105
TAW34800	7314150285471	1	105
TAW38135	7314150274956	1	105
TAW38135M	7314150502295	1	105
TAW912M	7314150423163	1	105
TAW9135	7314150340859	1	105
TAW9135M	7314150502288	1	105
TAW930M	7314150422319	1	105
TAWM12340	7314150274925	1	104
TAWM1412M	7314150423149	1	104
TAWM1430M	7314150422265	1	104
TAWM14340	7314150340835	1	104
TAWM24800	7314150368280	1	104
TAWM34800	7314150274932	1	104
TAWM38135	7314150274918	1	104
TAWM38135M	7314150502264	1	104
TAWM912M	7314150423132	1	104
TAWM9135	7314150340828	1	104
TAWM9135M	7314150502271	1	104
TAWM930M	7314150422241	1	104
TAWMB14340	7314150489626	1	104
TAWMB24650	7314150490103	1	104
TAWMB24800	7314150489633	1	104
TAWMB9135M	7314150490110	1	104
TAWMB930M	7314150489640	1	104
TEA003	7314150422180	1	114
TEA010	7314150422197	1	114
TEA030	7314150465781	1	114
TEA030A	7314150522750	1	114
TEA065	7314150472246	1	115
TEA1100	7314150423170	1	115
TEA2100	7314150465972	1	115
TEA350	7314150422210	1	115
TJS003	7314150522477	1	114
TJS010	7314150522484	1	114
TJS030	7314150522491	1	114
TL 00-SA	7314150109579	1	656
TL 00-SA-ET	7311518279219	1	659
TL 00-SA-SL	7314150115228	5	660
TL 000-SA	7314150522934	1	656
TL 00ACF	7314150522958	1	663
TL 00B-SA	7314150109555	1	656
TL 00CFR-SA	7314150115402	1	658
TL 00D-SA	7314150109562	1	656
TL 0C9-SA	7314150109586	1	656
TL 1-SA	7314150109647	1	656
TL 1-SA-SL	7314150115235	5	660



TL 124-SA	7314150110018	1	662
TL 15A	7314150522972	1	656
TL 15AGW	7314150522996	1	656
TL 15AGWHM-SA	7314150523016	1	656
TL 2-SA-SL	7314150115242	5	660
TL 242ACF	7314150523030	1	663
TL 242CFR-SA	7314150523054	1	658
TL 249 ACF	7314150115174	1	663
TL 249CFR-SA	7314150115143	1	658
TL 259 ACF	7314150115167	1	663
TL 259 CFR-SA	7314150115150	1	658
TL 259ACP	7314150465590	1	663
TL 259ASV	7314150465569	1	663
TL 259CPR-SA	7314150523078	1	658
TL 259SVR-SA	7314150523092	1	658
TL 2A ACF	7314150115457	1	663
TL 2A-SA	7314150110100	1	656
TL 2A-SA-ET	7314150523115	1	659
TL 2A-SA-SL	7314150115259	5	660
TL 2ACFR-SA	7314150115419	1	658
TL 3-SA	7314150110162	1	657
TL 3-SA-ET	7311518279356	1	659
TL 3-SA-SL	7314150115266	5	660
TL 34A-SA	7314150524068	1	657
TL 3C-SA	7314150110148	1	657
TL 3C-SA-ET	7314150523139	1	659
TL 3C-SA-SL	7314150115273	5	660
TL 4-SA-SL	7314150115280	5	660
TL 475-SA	7314150110032	1	662
TL 5-SA	7314150110247	1	657
TL 5-SA-ET	7314150523153	1	659
TL 5-SA-SL	7314150115297	5	660
TL 51S-SA	7314150110209	1	657
TL 578-SA	7314150110438	1	662
TL 582-SA	7314150110452	1	662
TL 5A-SA-SL	7314150115303	5	660
TL 5ACF	7314150115464	1	663
TL 5ACP	7314150465606	1	664
TL 5ASV	7314150465576	1	663
TL 5B-SA	7314150110223	1	657
TL 5CF-SA	7314150523177	1	658
TL 5CFR-SA	7314150115426	1	658
TL 5CPR-SA	7314150523191	1	658
TL 5SVR-SA	7314150523214	1	658
TL 6-SA	7314150523238	1	657
TL 648-SA	7314150110049	1	662
TL 649-SA	7314150110063	1	662
TL 65A-SA	7314150110278	1	657
TL 7-SA	7314150110292	1	657
TL 7-SA-ET	7314150523252	1	659
TL 7-SA-SL	7314150115310	5	661
TL 7A-SA	7314150110285	1	657
TL 7A-SA-ET	7314150523283	1	659
TL 7A-SA-SL	7314150115327	5	661
TL 7ACF	7314150115471	1	664
TL 7ACP	7314150465613	1	664
TL 7ASV	7314150465583	1	664
TL 7CFR-SA	7314150115433	1	659
TL 7CPR-SA	7314150523306	1	659
TL 7SVR-SA	7314150523320	1	659
TL AA-SA-ET	7314150523344	1	659
TL AA-SA-SL	7314150115334	5	660
TL AC-SA-SL	7314150115341	5	660
TL MM-SA-SL	7314150115365	5	661
TL SM 103-SA	7314150110773	1	662
TL SM 104-SA	7314150110780	1	661
TL SM 105-SA	7314150110797	1	661
TL SM 107-SA	7314150110810	1	661
TL SM 108-SA	7314150110827	1	661
TL SM 109-SA	7314150110834	1	661
TL SM 110-SA	7314150110841	1	661
TL SM 111-SA	7314150110858	1	661
TL SM 115-SA	7314150110896	1	662
TL SM 117-SA	7314150110919	1	662
TL SM106-SA	7314150523368	1	661
TL SM116-SA	7314150523382	1	661
TL SM116-SA-ET	7314150523405	1	659
TL SS-SA	7314150109937	1	657
TL SS-SA-SL	7314150115358	5	660
TR0325M03X-50	7314150501632	5	148
TR0636M06X-65	7314150501663	5	148
TR0650M06X-80	7314150501694	5	148
TR0860M08X-110	7314150507269	5	148
TR4.530M06X-90	7314150501755	5	148
TRX 8180	7314150112272	5	654
TSS120	7314150347063	1	112
TSS600	7314150346417	1	112
W-S-1.5	7311518140816	4	601
W-S-2.0	7311518140823	4	601



W-S-2.5	7311518140830	4	601
W-T-2.0	7311518140847	4	601
WBB1000	7314150431502	4	612
WBB1200	7314150431519	4	612
WBB1500	7314150431526	4	612
WBB400	7314150315215	10	612
WBB500	7314150315222	10	612
WBB600	7314150315239	10	612
WBB700	7314150315246	6	612
WBB800	7314150340972	6	612
WBF380	7314150315253	12	612
WBMF190	7314150315260	24	612
WBMF190IP	7314150457960	15	612
WBP-3P-3FMF	7314150444335	1	612
WBP-3P-6FMF	7314150453115	1	613
WBP-3P-96F	7314150453108	1	613
WBP300	7314150315161	20	612
WBP500	7314150315178	12	612
WBP625	7314150315185	12	612
WBP710	7314150315192	10	612
WBP900	7314150315208	6	612
WC-HOL	7314150333158	1	573
WPH 2-50	7314150520428	1	609
WPH 3-20	8412814125435	1	609
WPH 3-30	8412814125442	1	609
WR1	7314150167425	50	543
WR1-MM	7314150220069	50	543
WR2	7314150167432	25	543
WR2-12	7314150185627	25	543
WR2-MM	7314150220038	25	543
XLARGE	7314150437412	1	375
XXL	7314150504152	1	374
ZHVIDEOBAT	8414909180244	1	360
ZHVIDEOCHA	8414909180237	1	360



Contact Us

Argentina

A.M. de Justo 1750 3° A
C1107AFJ - Capital Federal
Buenos Aires
Tel: +54 (11) 4313-1004
Fax: +54 (11) 4893-3553

Australia

3 Cooper Street, Smithfield,
NSW 2164
Tel: +61 (0) 2 8787 5700
Fax: +61 (0) 2 9756 6130

Беларусь

ЗАО "Эс-Эн-Эй Европа Индастриз Бисов"
220075 СЭЗ "Минск"
ул. Селицкого, д. 8А
Телефон +375 (17) 389 79 50
info.by@snaeurope.com

Belgium

Branch of SNA Europe (Benelux) BV
De Kleetlaan 12A Pegasus Park
1831 DIEGEM
Tel: +32 (0)2 726 03 03
info.be@bahco.com

Chile

Av. Americo Vesputio 2760-D
Conchali - Santiago - Chile
Tel: + 56 2 623 0203
Fax: + 56 2 623 5395

Česká republika

SNA Europe s.r.o.
Holadnská 2/4
639 00 Brno
Tel: +420 537 022 520
Fax: +420 537 022 200

Danmark

Vallensbækvej 40,
2605 Brøndby
Tel: +45 4363 0330
Fax: +45 4396 2456

Deutschland

Willetstraße 10
40822 Mettmann
Tel: +49 (0) 2104 833 83 0
Fax: +49 (0) 2104 833 83 7999

España

c/ Hilanderas, 1
(P.O. Box / Ardo de Correos nº 5)
C.P. 20303 Irún
Tel: +34 902 235 100 / +34 943 649 111
Fax: +34 943 649 120

Ελλάδα

Λ. Βουλιαγμένης 604Γ
167 77 Ελληνικό, Αθήνα
Τηλ: +30 210 9914263
Fax: +30 210 9914587

Export

Antigua Carretera de Altube Km 5,5
P.O.Box 307
01080 VITORIA (Spain)
Tel: +34 945269711
Fax: +34 945165040

France

ZAC de l'Hoirie
20 rue Charles Lacretelle
CS 60101
49072 Beaucouzé cedex
Tél: +33 (0) 2 41 22 98 40
Fax: +33 (0) 2 41 22 98 50

Italia

SNA EUROPE Italia S.p.A.
Via Georges Bizet, 13/15
20092 Cinisello Balsamo MI - Italia
Tel. +39 02 3024161
info.it@snaeurope.com

Казахстан

050000, Алматы,
ул.Шевченко 1656/72г, оф.217
Тел/факс +7 727323 63 39

Nederland

Vossenbeemd 113
5705 CL Helmond
Tel: +31 (0) 492 58 23 82
info.nl@bahco.com

New Zealand

Unit 3/25 Highbrook Drive
East Tamaki
Auckland
Tel: +64 9-273 46 50
Fax: +64-9-273-2453

Norge

Box 800
1306 Sandvika
Tel: +47 40 49 66 00

Österreich

Vienna, Nineteen, Mooslackengasse 17
A - 1190 Wien
Tel: +49 (0) 2104 8 33 83 0
Fax +49 (0) 2104 833 83 79 99

Polska

ul. Marynarska 15
02-674 Warszawa
Tel.: +48 (0) 22 6070510
Fax: +48 (0) 22 6070521

Россия

ООО "Эс-Эн-Эй Юроп (РУС)"
141407 г. Химки
ул. Панфилова вл.21, стр.1
Телефон +7 (495) 221 58 51
info.ru@snaeurope.com

Portugal

SNA Europe [Industries] LDA
R. Maria Julia M. Ramos - Junqueira
4480-254 Vila Do Conde
Tel. +351 252 650 131
Fax. +351 252 650 160

Slovenská republika

SNA Europe s.r.o.
Karadžičova 8/A
821 08 Bratislava
Tel: +421 (0)2 5939 6124
Fax: +421 (0)2 5939 6217

SRBIJA

Vermax-alati doo
Ul. Drage Spasić 35
11000 Beograd
Tel: +381 11 2360 500
Tel: +381 11 2360 900
Fax: +381 11 2361 147
e-mail: office@vermax.rs

Suomi

SNA Europe Oy
PL 6580
00002 Helsinki
Finland
Tel: +358 207 433 510
Fax: +358 207 433 525

Sverige

SNA Europe Industries AB
Box 83
SE-745 22 Enköping
Tel: +46 (0) 171-47 82 00
Fax: +46 (0) 171-47 82 38

Schweiz / Suisse

Willetstraße 10
40822 Mettmann
Tel: +49 (0) 2104 833 83 0
Fax: +49 (0) 2104 833 83 7999

Türkiye

Girne Mah. Maltepe Küçük San. Sitesi
F Blok No:19 Maltepe
Istanbul
Tel: +90 (0) 216 367 10 21
Fax: +90 (0) 216 367 11 71

Украина

«Бахко Бисов Свенска Акциеболаг»
SNA Europe [Ukraine & Moldova]
Телефон +38 067 441 16 09
офис 555, улица Армянская, 6А
Киев, Украина

United Kingdom

Moorhead Way, Bramley,
Rotherham, South Yorkshire S66 1YY
Tel: +44 (0) 1709 731731
Fax: +44 (0) 1709 731741



Warranty

For warranty info please check your local website www.bahco.com



This catalogue comprises our current product assortment. Changes in the assortment as well as change of net shapes, forms, designs and designations are made continuously. No specific information will necessarily be issued to this effect.

Illustrations and drawings have been reproduced to be as accurate as possible. For the purposes of a catalogue they may, however, differ from the products themselves, as may the technical specifications.

Indications of weight are to be understood as approximate net weights, and serve primarily to facilitate calculations of freight and postage charges.

This catalogue supersedes all previous specifications and assortment lists.

The intellectual property in this catalogue is the property of SNA Europe. Excerpts, reprints or copies of the contents may be made with our permission

2024





www.bahco.com

M-ENG-CAT-24



7 314150 546657